



Contract Net Price List February 1st, 2016

Upholstery	2 - 7
Panel	8 - 9
Cubicle	10 - 11
Wall Surfaces	12 - 14
General Information	15 - 16
Technical Services	17
COM Approvals	17
Special Processing	18 - 19
Textile Numerical Index	20
Contact Info / Showrooms	21

Upholstery

Name AC No.	Contents / Description	Finish	Backing	Approx. Vert. Repeat	Approx. Horiz. Repeat	Width	Cost - 99 Yds. & Less	Cost - 100 Yds. & More
ALLEGRA® 68930-43	70% Cotton/30% Polyester	Crypton Stain Resistant		3 1/2" Half Drop	2 3/4"	54"	37.95	34.95
ALPHA 61190-204	100% Polyurethane Face 100% Polyester Knit Back; eco-tex ®	WriteOut™ Ink Resistant				54"	33.75	30.95
ANALOG 60880-94	100% Recycled Solution Dyed Nylon eco-tex ®	Stain Resistant	Acrylic	21 1/4"	14"	54"	55.95	51.50
ANTIGUA 60070-84	97% Vinyl/3% Polyurethane	Anti-microbial Anti-bacterial	100% Polyester			54"	34.95	31.95
APEX 61580-84	77% Recycled Polyester / 23% Nylon; eco-tex ®	INCASE™	Acrylic	18 1/2"	14 1/2"	54"	46.95	42.75
ARASHI 61480-90	100% Post Industrial Recycled Solution Dyed Nylon; eco-tex ®	Stain Resistant	Acrylic	6 1/4"	7"	54"	55.95	51.95
ASTRAL 61030-47	44% Nylon/31% Cotton/ 16% Recycled Polyester 9% Polyester; eco-tex ®	INCASE™ Stain Resistant	Acrylic	8 1/2"	9 1/4"	54"	47.75	43.95
AURORA 62020-28	56% Post Consumer Recycled Polyester/  43% Nylon/1% Polyester; eco-tex ®	Stain Resistant	Acrylic		9 1/4"	54"	38.95	35.95
AXIS® 61340-56	100% Vinyl Face/100% Polyester Back	MorCare™ Stain Resistant				54"	48.95	45.75
BAUBLE® 68090-98	52% Polyester/48% Cotton	Teflon	Acrylic	3 1/4"	2 1/4"	54"	55.25	50.95
BEAT BOX® 68770-77	47% Polyester/32% Cotton/  21% Rayon	Crypton Stain Resistant		14 1/2"	8"	54"	44.95	41.75
BLOCK PARTY® 69670-83	49% Cotton/35% Nylon/16% Polyester	Nano-Tex Stain Resistant	Acrylic	11 1/2"	9"	54"	61.75	56.95
BLOOM® 61010-24	67% Acrylic / 33% Polyester	Nano-Tex Stain Resistant	Dura-Blok	12 1/2"	14"	54"	57.75	53.50
BLOSSOM® 69470-80	51% Cotton/37% Nylon/12% Polyester	Nano-Tex Stain Resistant	Acrylic	9"	12 1/4"	54"	53.25	48.95
BOARDWALK® 6110-29	100% Post Consumer Recycled Polyester eco-tex ®	Stain Resistant	Acrylic	3 1/4"	7"	54"	31.95	29.95
BOUNCE® 67750-61	61% Cotton/39% Polyester	Crypton Stain Resistant		11"	7"	54"	55.95	51.75
BOURBON STREET 68240-51	50% Polyester/50% Cotton	Crypton Stain Resistant			1"	54"	46.75	42.95
BRONCO 69360-82	100% Polyurethane Face 100% Polyester Knit Back; eco-tex ®	WipeOUT™ Stain Resistant Aegis Microbe Shield®				54"	39.65	36.75
BUBBLY® 69310-25	58% Cotton/33% Nylon/9% Polyester	Nano-Tex Stain Resistant	Acrylic	10"	9"	54"	53.25	49.25
CAMPUS STRIPE 60770-83	100% Polyester 	Crypton Stain Resistant			11"	54"	44.25	40.75
CANDY LAND 69530-41	100% Solution Dyed Nylon	Nano-Tex Stain Resistant	Acrylic	7 1/4"	7 1/4"	54"	52.95	48.95
CARNIVAL 69390-97	100% Polyurethane Face 100% Polyester Knit Back; eco-tex ®	WipeOUT™ Stain Resistant Aegis Microbe Shield®				54"	39.75	36.65
CASABLANCA® 60390-407	62% Recycled Polyester/ 38% Nylon; eco-tex ®	Teflon	Acrylic	14 1/2"	9 1/2"	54"	48.95	45.25
CASCADE® 61840-52	61% Recycled Polyester  39% Polyester; eco-tex ®	Crypton Green Stain Resistant		3 1/2"	2 1/4"	54"	48.95	45.95
CASSIO® 68950-59	57% Cotton/43% Polyester 	Crypton Stain Resistant		3 1/2"	5 1/2"	54"	34.95	31.95
CHANNEL 61620-43	100% Polyurethane Face 100% Polyester Knit Back; eco-tex ®	WriteOut™ Ink Resistant				54"	35.95	32.95
CHIT-CHAT® 69290-301	58% Post Consumer Recycled Polyester/ Reversible 42% Post Industrial Recycled Polyester; eco-tex ®			17 1/2" Half Drop	7"	54"	31.25	28.95
CHROMA 60130-65	90% Vinyl/10% Urethane Face/ 100% Polyester Hi-Loft Back	AG SilverGuard™ Perma-blok Stain Resistant				54"	34.50	31.75
CIRCUIT® 1 68100-11	53% Cotton/33% Nylon/14% Polyester	Teflon	Acrylic	17 1/2"	9"	54"	61.75	56.95
CIRQUE 60430-51	63% Post Consumer Recycled Polyester/ 25% Nylon / 12% Polyester; eco-tex ®	Crypton Green Stain Resistant		10"	9 1/2"	54"	53.95	49.95
CLARION® 60020-33	47% Post Consumer Recycled Polyester/ 27% Nylon/26% Polyester; eco-tex ®	Nano-Tex Stain Resistant	Acrylic	2"	3 1/4"	54"	47.95	44.50
COASTLINE 61650-75	100% Polyester	INCASE™ Stain Resistant	Acrylic			54"	37.95	34.95

Upholstery

Name AC No.	Contents / Description	Finish	Backing	Approx. Vert. Repeat	Approx. Horiz. Repeat	Width	Cost - 99 Yds. & Less	Cost - 100 Yds. & More
COLUMN® 61300-12	61% Polyester/ 38% Recycled Polyester 1% Nylon; eco-tex ®	Stain Resistant	Acrylic	5 3/4"		55"/56"	35.95	32.75
COMPASS® 61440-51	74% Post Consumer Recycled Polyester/ 26% Nylon; eco-tex ®	Nano-Tex Stain Resistant	Acrylic	28"	27 3/4"	54"	49.95	44.75
CONSTANTINE® 69620-35	100% Trevira CS Polyester	Teflon		13 1/4"	13 1/4"	54"	69.95	64.50
CONTOUR 62050-63	100% Vinyl/ 100% Polyester Hi-Loft Back	AG SilverGuard™ PBG+ Stain Resistant		18"	18"	54"	31.95	29.95
CROSSROADS® 61090-107	58% Polyester / 42% Recycled Polyester; eco-tex ®	Crypton Green Stain Resistant				54"	40.75	37.75
DAKOTA 69920-35	100% Vinyl Face/ 75% Polyester/25% Cotton Back					54"	28.75	27.50
DAKOTA 2 61690-701	100% Vinyl Face/ 75% Polyester/25% Cotton Back					54"	28.75	27.50
DAZZLE® 61070-85	51% Acrylic/32% Polyester/17% Cotton	Stain Resistant	Acrylic			54"	68.95	64.50
DELPHI® 61320-32	78% Polyester/ 21% Recycled Polyester 1% Nylon; eco-tex ®	Stain Resistant	Acrylic			55"/56"	29.95	27.75
DELTA 69840-64	68% Post Consumer Recycled Polyester 32% Polyester; eco-tex ®	Crypton Green Stain Resistant				54"	30.95	28.75
DIAMOND DERBY® 1 67170-77	48% Nylon/32% Cotton/20% Polyester	Teflon	Acrylic	9"	9"	54"	58.95	54.50
DUCHESS® 1 68490-501	55% Cotton/45% Polyester; Reversible			3 1/2"	3 1/2"	54"/55"	17.75	15.75
DURANGO 2 67560-601	100% Vinyl Face/100% Polyester Back	Perma-blok Stain Resistant				54"	23.35	21.50
DYNASTY 60500-31	100% Polyurethane Face 100% Polyester Knit Back; eco-tex ®	WipeOUT™ Stain Resistant Aegis Microbe Shield®				54"	41.95	38.50
ECHO 69510-21	41% Polyester/37% Acrylic/ 22% Rayon	Crypton Stain Resistant		16 1/2"	Half Drop 14 1/2"	54"	43.95	40.75
ECLIPSE® 68820-29	93% Post Industrial Recycled Polyester (R)(R) 7% Post Consumer Recycled Polyester; eco-tex ®	Crypton Green Stain Resistant		3 3/4"	3 1/2"	54"	42.50	39.25
EMPRESS 61860-83	100% Vinyl Face/100% Polyester Back	Resilience Stain Resistant				54"	27.50	25.25
ETC.® 69260-75	100% Solution Dyed Nylon	Nano-Tex Stain Resistant	Acrylic	3 3/4"	5 1/4"	54"	48.75	44.95
ETCH® 68150-65	90% Vinyl/10% Polyurethane Face/ 100% Polyester Back	Perma-blok Stain Resistant				54"	33.50	31.50
FACET 60560-70	55% Solution Dyed Nylon/ 45% Post Industrial Recycled Dyed Nylon; eco-tex ®	Nano-Tex Stain Resistant	Acrylic	34"	6 3/4"	54"	50.95	46.95
FIORE 69550-57	100% Polyester (R)(R)	Crypton Stain Resistant		14 1/2"	9"	54"	55.25	50.95
FIREFLIES® 66520-29	100% Vinyl Face/100% Polyester Back	Perma-blok Stain Resistant		Random		54"	33.75	31.25
FORSYTHIA® 2 68030-42	55% Cotton/45% Polyester (R)(R)	Crypton Stain Resistant		14"	13 3/4"	54"	48.75	44.95
FRANCESCA WOOL 66150-69	52% Wool/48% Acrylic Face/ 100% Cotton Back		FR Acrylic			55"	63.75	58.95
FRANCESCA WOOL II 68120-31	52% Wool/48% Acrylic Face/ 100% Cotton Back		FR Acrylic			55"	63.75	58.95
FRONTIER 67480-504	100% Vinyl Face/100% Polyester Back					54"	22.95	20.95
GALAXY 60170-85	50% Post Industrial Recycled Nylon/ 50% Nylon; eco-tex ®	Stain Resistant	Acrylic	14 1/2"	14 1/2"	54"	44.50	40.95
GAMMA 61890-912	100% Polyurethane Face 100% Polyester Knit Back; eco-tex ®	WriteOut™ Ink Resistant				54"	33.75	30.95
GARDENIA 61380-87	100% Vinyl Face 100% Polyester Hi-Loft Back	AG SilverGuard™ Perma-blok Stain Resistant		15 1/4"	17 1/2"	54"	34.95	31.95
GATSBY 69010-32	100% Vinyl Face/100% Polyester Back	Resilience Stain Resistant		1 1/2"	1 1/2"	54"	28.25	25.95
GEM 67970-81	90% Vinyl/10% Urethane Face/ 100% Polyester Back	Perma-blok Stain Resistant				54"	32.75	30.25
GLIMMER 60330-47	52% Nylon / 48% Polyester	INCASE™ Stain Resistant	Acrylic	Allover		54"	45.95	42.50

Upholstery

Name AC No.	Contents / Description	Finish	Backing	Approx. Vert. Repeat	Approx. Horiz. Repeat	Width	Cost - 99 Yds. & Less	Cost - 100 Yds. & More
GRAND CENTRAL® 68750-63	100% Solution Dyed Nylon (R/R)		Acrylic	4 3/4"	4 1/4"	54"	37.95	34.95
GRID 61240-55	74% Post Consumer Recycled Polyester/ 26% Nylon; eco-tex®	Nano-Tex Stain Resistant	Acrylic	7"	9 1/4"	54"	43.75	40.50
HARLEQUIN 61730-50	78% Post Consumer Recycled Polyester/ 22% Nylon; eco-tex®	Nano-Tex Stain Resistant	Acrylic	19 1/4"	9 1/2"	54"	51.95	47.75
HIGHLANDS 61960-73	100% Polyester	Stain Resistant	Acrylic			54"	53.95	49.95
HOPSCOTCH® 67250-60	100% Recycled Polyester eco-tex®		Recyclable Polyester	27"	14"	54"	32.25	29.75
HUSH 62110-36	70% Wool/20% Polyester/ 5% Acrylic/5% Nylon; eco-tex®					56"/57"	37.35	35.75
IGUANA 67530-55	87% Vinyl/ 10% Polyester/3% Polyurethane/ 100% Polyester Back					54"/56"	34.95	31.95
ILLUSION 68580-97	100% Vinyl Face/100% Polyester Back	Resilience Stain Resistant				54"	22.25	20.50
ILLUSION 2 62090-108	100% Phthalate Free Vinyl Face/ 100% Brushed Polyester Back	Resilience Stain Resistant				54"	22.25	20.50
INTAGLIO 69400-19	100% Polyurethane Face 100% Polyester Knit Back; eco-tex®	WipeOUT™ Stain Resistant Aegis Microbe Shield®				54"	40.95	37.75
INTAGLIO 2 61410-32	100% Polyurethane Face 100% Polyester Knit Back; eco-tex®	WipeOUT™ Stain Resistant Aegis Microbe Shield®				54"	40.95	37.75
INTERSECT 69560-78	66% Post Consumer Recycled Polyester/ 34% Post Industrial Recycled Polyester; eco-tex®	Nano-Tex Stain Resistant	Polyester	5"	5"	54"	37.75	34.95
ISABELLA 60850-66	100% Vinyl Face/100% Polyester Back	Resilience Stain Resistant		2 1/2"	1 1/4"	54"	27.95	25.95
ITAJIME 61540-51	100% Post Industrial Recycled Solution Dyed Nylon; eco-tex®	Stain Resistant	Acrylic	10"	13 3/4"	54"	51.95	47.95
JARDIN® 68340-46	54% Cotton/46% Polyester	Crypton Stain Resistant		26 1/2"	13 1/2"	54"	49.25	45.50
JING 68350-61	90% Vinyl/10% Polyurethane Face/ 100% Polyester Back	Perma-blok Stain Resistant				54"	34.95	32.25
JIVE 61590-603	78% Polyester / 22% Solution Dyed Nylon	Stain Resistant	Acrylic	14 3/4"	14 1/2"	55"/56"	39.95	36.95
JULIET® 69240-52	65% Post Consumer Recycled Polyester/ 35% Polyester; eco-tex®	Crypton Green Stain Resistant		24 1/2"	14 1/2"	54"	62.75	57.95
KATANO 61520-30	100% Post Industrial Recycled Solution Dyed Nylon; eco-tex®	Stain Resistant	Acrylic	11 1/2"	4 1/2"	54"	41.95	37.95
KEY® 61260-72	80% Polyester/ 19% Recycled Polyester 1% Nylon; eco-tex®	Stain Resistant	Acrylic	15 1/2"	14 1/2"	55"/56"	37.85	34.95
KINETIC® 60680-93	40% Nylon/28% Polyester/ 21% Post Ind. Rec. Poly/ 11% Post Consr. Rec. Poly eco-tex®	INCASE™ Stain Resistant	Acrylic	9 1/2"	9 3/4"	54"	51.75	47.95
KIRIGAMI 60310-25	100% Polyester	Stain Resistant	Acrylic	2 1/2" Half Drop	4 3/4"	54"	44.95	41.50
KUMO 61500-10	100% Post Industrial Recycled Solution Dyed Nylon; eco-tex®	Stain Resistant	Acrylic	13 3/4"	13 3/4"	54"	55.95	51.95
LANCASTER® 1 68510-21	55% Cotton/45% Polyester			19"	6 3/4"	54"/55"	17.75	15.75
LAUREL 69600-15	60% Polyester/40% Nylon	INCASE™ Stain Resistant	Polyester	13 3/4"	14 1/2"	54"	51.95	47.95
LEAFLET® 60250-64	50% Post Industrial Recycled Polyester/ 50% Nylon; eco-tex®	Stain Resistant	Acrylic	14 1/2"	14 1/2"	54"	44.50	40.95
LEGACY 69440-64	100% Polyester	Crypton Stain Resistant				54"	42.95	39.95
LEONARDO® 68920-24	60% Cotton/40% Polyester (R/R)	Crypton Stain Resistant		7"	24 1/2"	54"	34.95	31.95
LOTUS® 68840-48	53% Rayon/47% Polyester	Nano-Tex Stain Resistant	Acrylic	22"	14 1/2"	54"	31.75	29.50
LUXE 60610-27	58% Acrylic/42% Polyester	Teflon	Acrylic			54"	44.95	41.95
LYRE® 61280-92	100% Polyester	Stain Resistant	Acrylic	7"	7 1/4"	55"/56"	33.85	29.95
LYRIC® 60650-62	100% Vinyl Face/100% Polyester Back	MorCare™ Stain Resistant		15"	6 3/4"	54"	47.95	43.95

Upholstery

Name AC No.	Contents / Description	Finish	Backing	Approx. Vert. Repeat	Approx. Horiz. Repeat	Width	Cost - 99 Yds. & Less	Cost - 100 Yds. & More
MARATHON 60290-307	100% Polyurethane Face 100% Polyester Back; eco-tex [®]	AG SilverGuard™ PERMAGUARD [®] Stain Resistant				54"	35.75	33.95
MASON 61800-10	100% Vinyl Face/ 100% Polyester Hi-Loft Back	AG SilverGuard™ Stain Resistant		8 1/4"	8 1/4"	54"	52.95	48.95
MASQUERADE [®] 68570-78	50% Acrylic/43% Polyester/7% Nylon	Nano-Tex Stain Resistant		13 1/2"	14"	54"	46.95	43.50
MEADOW [®] 60990-61000	100% Vinyl Face/100% Polyester Back	MorCare™ Stain Resistant		16"	16"	54"	47.95	43.95
MERIDIAN [®] 60190-201	100% Polyester	Nano-Tex Stain Resistant	Acrylic		4 1/2"	54"	19.95	17.65
MESA 69870-84	60% Post Consumer Recycled Polyester 40% Polyester; eco-tex [®]	Crypton Green Stain Resistant				54"	34.50	31.75
METRO [®] 60720-30	100% Polyester/ (R)(R)	Greenshield Stain Resistant	Acrylic	10"	22 1/4"	54"	62.25	57.50
MIRROR, MIRROR 61460-71	100% Polyester	Stain Resistant	Acrylic	12 1/2"	14"	54"	45.95	41.75
MONTE CARLO [®] 69640-55	66% Post Consumer Recycled Polyester/ (R)(R) 34% Post Industrial Recycled Polyester; eco-tex [®]	Crypton Green Stain Resistant		3 1/2"	4 3/4"	54"	46.50	42.95
MOON BEAM 68620-41	61% Polyester/27% Cotton/11% Rayon/ 1% Nylon	Crypton Stain Resistant				54"	47.75	43.95
MOON BEAM 2 60580-604	61% Polyester/27% Cotton/11% Rayon/ 1% Nylon	Crypton Stain Resistant				54"	47.75	43.95
MOROCCO 60410-24	45% Polyester/34% Acrylic/ 15% Cotton/6% Viscose	Stain Resistant	Acrylic	8"		54"	49.50	45.60
MURANO 69770-90	53% Polyester/41% Acrylic/6% Viscose (R)(R)	INCASE™ Stain Resistant	Acrylic	14 1/4"	7 1/4"	54"	44.95	39.95
MYSTIQUE [®] 68710-26	55% Acrylic/28% Polyester/17% Cotton		Acrylic			54"	41.25	37.95
NAVIGATOR 69490-502	100% Solution Dyed Nylon	Nano-Tex Stain Resistant	Acrylic	3" Half Drop	5"	54"	43.50	40.25
NETWORK 60060-69	56% Polyester/44% Acrylic	Nano-Tex Stain Resistant		1 1/4"	1 3/4"	54"	76.50	70.75
NIAGARA 69580-93	55% Post Industrial Recycled Polyester/ (R)(R) 45% Post Consumer Recycled Polyester; eco-tex [®]	Crypton Green Stain Resistant		3 1/4"	2 1/2"	54"	50.95	46.95
NOVA 60000-18	62% Polyester/38% Nylon	INCASE™ Stain Resistant	Acrylic	16 1/4"	14 1/2"	54"	53.25	48.95
OASIS 69040-56	100% Post Industrial Recycled Polyester eco-tex [®]	Crypton Green Stain Resistant				54"	58.50	53.95
ODYSSEY 61780-92	80% Polyester/19% Post Consumer Recycled Polyester/1% Nylon; eco-tex [®]	Stain Resistant				55"/56"	37.85	34.95
OMEGA 61160-82	100% Polyurethane Face 100% Polyester Knit Back; eco-tex [®]	WriteOut™ Ink Resistant				54"	33.75	30.95
ORION [®] 61920-33	100% Polyester; eco-tex [®]	Stain Resistant	Acrylic	5 3/4"	4 3/4"	54"	35.95	33.95
PALA 68210-17	34% Cotton/34% Viscose/20% Polyester/ 12% Acrylic			1 3/4"	1 3/4"	54"	58.95	53.95
PALATINE 68450-65	65% Polyester/35% Rayon	Crypton Stain Resistant				54"/55"	38.95	35.50
PALATINE 2 61210-35	65% Polyester/35% Rayon	Crypton Stain Resistant				54"/55"	38.95	35.50
PANACHE [®] 68410-21	58% Rayon/42% Recycled Polyester (R)(R)	Nano-Tex Stain Resistant		7 1/2"	3 1/2"	58"/59"	33.50	30.95
PARCHMENT 1 68140-49	64% Cotton/36% Polyester				1 3/4"	56"/57"	59.95	56.95
PEBBLE BEACH 2 66530-52	100% Vinyl Face/100% Polyester Back	Perma-blok Stain Resistant				54"	31.50	29.25
PINBALL [®] 67720-27	59% Polyester/41% Cotton	Crypton Stain Resistant		2 3/4"	1 3/4"	54"	41.25	37.95
PINPOINT [®] 68910-18	50% Polyester/41% Cotton/9% Rayon	Nano-Tex Stain Resistant	Acrylic	3 1/2"	3 1/2"	54"	40.95	37.75
PLATEAU 69800-15	100% Polyester	Crypton Stain Resistant				54"	32.25	29.75
POLISHED 60740-69	100% Polyurethane Face 100% Polyester Back; eco-tex [®]	WipeOUT™ Stain Resistant Aegis Microbe Shield [®]				54"	39.95	36.95

Upholstery

Name AC No.	Contents / Description	Finish	Backing	Approx. Vert. Repeat	Approx. Horiz. Repeat	Width	Cost - 99 Yds. & Less	Cost - 100 Yds. & More
POLO 69760-68	50% Post Industrial Recycled Nylon/ 50% Nylon; eco-tex®	Stain Resistant	Acrylic	5 3/4"	7 1/4"	54"	42.75	39.50
POSH 67770-96	100% Polyester	Crypton Stain Resistant				54"	54.95	49.95
PRISM 60210-46	100% Polyester	INCASE™ Stain Resistant	Acrylic			54"	23.25	21.50
PROVENCE® 60670-77	66% Polyester/34% Viscoe	Stain Resistant		14 1/2"	25 1/2"	54"	105.95	97.85
QUAD 69430-36	53% Post Ind. Rec. Poly/13% Post Consr. Rec. Poly/34% Polyester; eco-tex®	Nano-Tex Stain Resistant	Acrylic	3"	3"	54"	52.50	48.50
RADIANT® 69280-87	100% Polyester; Reversible	Nano-Tex Stain Resistant		13" Half Drop	14"	54"	52.35	48.25
RADIUS® 61140-54	79% Post Consumer Recycled Polyester 21% Nylon; eco-tex®	Nano-Tex Stain Resistant	Acrylic	14"	13 3/4"	54"	51.75	47.75
RAVENNA 60540-57	70% Polyester / 26% Acrylic / 4% Nylon	Nano-Tex Stain Resistant	Dura-Blok	7 1/4"	7 1/4"	54"	44.95	40.95
RHYTHM 68290-305	100% Polyester (RXR)	Crypton Stain Resistant			8"	54"	40.25	37.25
RINGLING 69660-67	100% Polyester	Crypton Stain Resistant		9 3/4"	7 1/4"	54"	48.95	45.25
RIVIERA® 68870-80	38% Cotton/ 36% Nylon/ (RXR) 26% Polyester	Nano-Tex Stain Resistant	Acrylic	9 1/4"	10 1/2"	54"	58.25	53.75
ROBOTIC 60790-802	100% Polyester	Crypton Stain Resistant		3 3/4"	3 3/4"	54"	47.95	44.50
RODEO 69940-88	100% Vinyl Face/ 100% Brushed Polyester Knit Back	Resilience Stain Resistant				54"	25.25	22.95
ROUNDAABOUT® 60090-105	100% Post Consumer Recycled Polyester eco-tex®	GreenShield Stain Resistant		11 1/2"	7"	55"	33.50	30.75
ROYAL GARDEN® 67910-17	100% Polyester	Crypton Stain Resistant		21 3/4"	14 1/4"	54"	55.95	51.75
SAGRADA® 68800-12	48% Cotton/35% Nylon/17% Polyester	Nano-Tex Stain Resistant	Acrylic	27"	9"	54"	65.50	60.50
SAHARA 60110-24	54% Post Consumer Recycled Polyester/ 46% Bamboo Rayon; eco-tex®	GreenShield Stain Resistant	Acrylic			55"	41.75	38.50
SAMBA 60630-42	55% Polyester/ 45% Post Consumer Recycled Polyester; eco-tex®	Crypton Stain Resistant		7 1/2"	9 3/4"	54"	45.25	41.75
SANTA FE 60270-88	57% Polyester/25% Viscose/18% Cotton	Stain Resistant				54"	45.95	41.95
SAVANNAH® 68230-36	50% Polyester/50% Cotton	Crypton Stain Resistant		7 1/4"	6 3/4"	54"	46.75	43.25
SEQUOIA 61390-400	61% Polyester /39% Solution Dyed Nylon	INCASE™	Acrylic	13 3/4"	14 1/2"	55"/56"	45.95	41.75
SHERLOCK 61940-55	73% Polyester/27% Viscoe	Nano-Tex Stain Resistant	Acrylic			54"	32.95	29.95
SHIBORI 60040-57	62% Polyester/38% Nylon	INCASE™ Stain Resistant	Acrylic	7 1/2"	7 1/4"	54"	52.75	48.75
SHIMMER 69210-34	90% Vinyl/10% Urethane Face 100% Polyester Hi-Loft Back	AG SilverGuard™ Perma-blok Stain Resistant				54"	30.95	28.25
SHIMMER 2 62000-11	90% Vinyl/10% Urethane Face 100% Polyester Hi-Loft Back	AG SilverGuard™ Perma-blok Stain Resistant				54"	30.95	28.25
SILVERADO 67650-69	100% Vinyl Face/100% Polyester Back	Perma-Block Stain Resistant				54"	31.75	29.25
SPECTRUM 69690-730	100% Polyurethane Face 100% Polyester Back; eco-tex®	Enhanced Stain Resistant				54"	27.25	24.95
SPIN 61760-72	100% Vinyl/ 100% Polyester Hi-Loft Back	AG SilverGuard™ Stain Resistant		10 3/4"	10 3/4"	54"	54.50	49.95
SPIRIT 60460-92	100% Polyester	INCASE™ Stain Resistant	Acrylic			54"	29.75	26.50
SPOT ON 60810-21	100% Polyester	Crypton Stain Resistant		3 1/2"	3 3/4"	54"	50.75	46.75
SPOTLIGHT® 68890-904	58% Polyester/42% Viscose	Nano-Tex Stain Resistant		10 1/2"	6 3/4"	54"	50.75	46.95
SPRING® 68960-73	60% Post Consumer Recycled Polyester/ 40% Polyester; eco-tex®	Crypton Green Stain Resistant		13 1/2"	14 1/2"	54"	51.75	47.75

Upholstery

Name AC No.	Contents / Description	Finish	Backing	Approx. Vert. Repeat	Approx. Horiz. Repeat	Width	Cost - 99 Yds. & Less	Cost - 100 Yds. & More
SPYRO® 69900-09	65% Post Consumer Recycled Polyester/ 35% Polyester; eco-tex ®	Greenshield Stain Resistant	Polyester	12 1/2"	14"	54"	45.50	41.95
STONEHENGE® 68470-80	67% Rayon/33% Polyester (R) (R)	Nano-Tex Stain Resistant	Acrylic	13 1/2"	16 3/4"	54"	48.95	45.25
STRAND-IT® 68730-40	42% Cotton/38% Polyester/ 20% Rayon	Crypton Stain Resistant		6 3/4"	14 1/4"	54"	55.95	51.75
STRATA® 68850-63	90% Vinyl/10%Polyurethane Face/ 100% Polyester Back	Perma-blok Stain Resistant				54"	30.95	28.65
STREAMLINE 62070-82	100% Vinyl/ 100% Polyester Hi-Loft Back	AG SilverGuard™ PBG+ Stain Resistant		18" Half Drop	18"	54"	30.95	29.75
SUEDE SENSATION 1 67400-19	100% Polyester	Crypton Stain Resistant				54"	32.95	29.95
SYMPHONY® 68280-85	100% Polyester	Crypton Stain Resistant		14 3/4"	14 1/2"	54"	46.75	43.25
TALLY 60830-47	100% Vinyl Face/100% Polyester Back	Perma-Block Stain Resistant		6"	6"	54"	30.95	28.95
TANGO® 68220-27	100% Solution Dyed Nylon	Teflon	Acrylic	6 1/4"	2 1/2"	54"	52.50	48.50
TATAMI® 1 67380-97	40% Cotton/35% Nylon/25% Linen	Teflon	Acrylic			54"	58.25	53.75
TECTONIC 61360-70	100% Vinyl Face/100% Polyester Back	AG SilverGuard™ Perma-Block Stain Resistant		18"	6"	54"	32.95	29.95
TEMPO 69340-51	100% Recycled Polyester (R) (R)	Nano-Tex Stain Resistant	Dura-Blok		13"	54"	41.95	38.75
TERRAIN 69890-99	100% Polyester	Nano-Tex Stain Resistant	Acrylic			54"	35.50	32.75
THE PLAID 61610-15	87% Polyester/13% Acrylic	Stain Resistant	Acrylic	15 1/2"	14 1/4"	55"/56"	69.95	64.95
THEORY 60350-82	50% Post Consumer Recycled Polyester/ 50% Polyester; eco-tex ®	Stain Resistant	Latex			54"	18.50	16.95
TRIO® 68530-40	100% Solution Dyed Nylon	Stain Resistant	Acrylic	11"	3 1/2"	54"	37.95	34.95
TUSCANY® 1 68050-58	100% Vinyl Face/100% Polyester Back (R) (R)	MorCare™ Stain Resistant		11 1/4"	7"	54"	43.25	39.95
UPTOWN® 68440-48	53% Cotton/35% Nylon/12% Polyester	Nano-Tex Stain Resistant	Acrylic	8"	9"	53"/54"	67.75	62.50
URBAN® 60700-18	49% Cotton/38% Nylon/ 13% Post Consumer Recycled Polyester; eco-tex ®	Nano-Tex Stain Resistant	Acrylic	13 1/2"	20"	54"	45.50	41.95
VELOCITY 61980-98	100% Vinyl/ 100% Polyester Hi-Loft Back	AG SilverGuard™ Stain Resistant		18"	20"	54"	54.50	49.95
VIBRATO® 1 68690-704	100% Recycled Polyester eco-tex ®					60"	31.25	28.95
VINEYARD 61710-21	100% Polyester	Stain Resistant	Acrylic	13 1/2"	14"	54"	45.95	41.75
VISTA 69820-37	50% Post Consumer Recycled Polyester 50% Polyester; eco-tex ®	Crypton Green Stain Resistant				54"	27.95	25.95
VOLLEY® 68830-37	85% Post Indust. Recycled Polyester/ 15% Post Cons. Recycled Polyester; eco-tex ®	Crypton Green Stain Resistant		8 3/4"	1 3/4"	56"/57"	47.25	43.75
VOLT® 61130-36	52% Cotton / 48% Polyester (R) (R)	Stain Resistant	Acrylic	3 1/8"	28"	54"	79.95	73.95
WONDERLAND® 68650-58	61% Polyester/39% Acrylic	Crypton Stain Resistant		19 3/4"	13 1/2"	54"	44.25	40.75
YO-YO® 69140-51	54% Cotton/30% Nylon/16% Polyester	Nano-Tex Stain Resistant	Acrylic	20"	9"	54"	55.95	51.75
ZIP LINE 61680-85	69% Recycled Polyester / 31% Nylon; eco-tex ®	INCASE™	Acrylic	9 1/4"	17 3/4"	54"	49.95	46.95

Notification must be given when fabric is intended for wall application.
All our upholstery fabrics pass California Technical Bulletin 117. For additional testing information, see technical data on sample ticket.

Note: Information regarding wearability and/or fire code data can be obtained by contacting your Account Manager or our Customer Service Department.

Reference Key

- 1 Phasing out (please check stock before specifying)
- 2 Selected colors phasing out (please check stock before specifying)
- (R) (R) Design is sampled railroaded

Panel

Name AC No.	Contents / Description	Finish	Backing	Approx. Vert. Repeat	Approx. Horiz. Repeat	Width	Cost - 99 Yds. & Less	Cost - 100 Yds. & More
ALPHA 61190-204	100% Polyurethane Face 100% Polyester Knit Back; eco-tex [®]	WriteOut™ Ink Resistant				54"	33.75	30.95
BOARDWALK® 61110-29	100% Post Consumer Recycled Polyester eco-tex [®]	Stain Resistant	Acrylic	3 1/4"	7"	54"	31.95	29.95
BRONCO 69360-82	100% Polyurethane Face 100% Polyester Knit Back; eco-tex [®]	WipeOUT™ Stain Resistant Aegis Microbe Shield®				54"	39.65	36.75
CHANNEL 61620-43	100% Polyurethane Face 100% Polyester Knit Back; eco-tex [®]	WriteOut™ Ink Resistant				54"	35.95	32.95
CHIT-CHAT® 69290-301	58% Post Consumer Recycled Polyester/ Reversible 42% Post Industrial Recycled Polyester; eco-tex [®]			17 1/2"	Half Drop	7"	31.25	28.95
CHROMA 60130-65	90% Vinyl/10% Urethane Face/ 100% Polyester Hi-Loft Back	AG SilverGuard™ Perma-blok Stain Resistant				54"	34.50	31.75
COASTLINE 61650-75	100% Polyester	INCASE™ Stain Resistant	Acrylic			54"	37.95	34.95
COLUMN® 61300-12	61% Polyester/ 38% Recycled Polyester 1% Nylon; eco-tex [®]	Stain Resistant	Acrylic	5 3/4"		55"/56"	35.95	32.75
CONSTANTINE 69620-35	100% Trevira CS Polyester	Teflon		13 1/4"	13 1/4"	54"	74.95	69.25
CONTOUR 62050-63	100% Vinyl/ 100% Polyester Hi-Loft Back	AG SilverGuard™ PBG+ Stain Resistant		18"	18"	54"	31.95	29.95
DAZZLE® 61070-85	51% Acrylic/32% Polyester/17% Cotton	Stain Resistant	Acrylic			54"	68.95	64.50
DYNASTY 60500-31	100% Polyurethane Face 100% Polyester Knit Back; eco-tex [®]	WipeOUT™ Stain Resistant Aegis Microbe Shield®				54"	41.95	38.50
GAMMA 61890-912	100% Polyurethane Face 100% Polyester Knit Back; eco-tex [®]	WriteOut™ Ink Resistant				54"	33.75	30.95
HOPSCOTCH® 67250-60	100% Recycled Polyester eco-tex [®]		Recyclable Polyester	27"	14"	54"	32.25	29.75
INTAGLIO 69400-419	100% Polyurethane Face 100% Polyester Knit Back; eco-tex [®]	WipeOUT™ Stain Resistant Aegis Microbe Shield®				54"	40.95	37.75
INTAGLIO 2 61410-32	100% Polyurethane Face 100% Polyester Knit Back; eco-tex [®]	WipeOUT™ Stain Resistant Aegis Microbe Shield®				54"	40.95	37.75
INTERSECT 69560-78	66% Post Consumer Recycled Polyester/ 34% Post Industrial Recycled Polyester; eco-tex [®]	Nano-Tex Stain Resistant	Polyester	5"	5"	54"	37.75	34.95
KEY® 61260-72	80% Polyester/ 19% Recycled Polyester 1% Nylon; eco-tex [®]	Stain Resistant	Acrylic	15 1/2"	14 1/2"	55"/56"	37.85	34.95
LYRE® 61280-92	100% Polyester	Stain Resistant	Acrylic	7"	7 1/4"	55"/56"	33.85	29.95
MASON 61800-10	90% Vinyl/10% Urethane Face/ 100% Polyester Hi-Loft Back	AG SilverGuard™ Stain Resistant		8 1/4"	8 1/4"	54"	52.95	48.95
MERIDIAN® 60190-201	100% Polyester	Nano-Tex Stain Resistant	Acrylic		4 1/2"	54"	19.95	17.65
ODYSSEY 61780-92	80% Polyester/19% Post Consumer Recycled Polyester/1% Nylon; eco-tex [®]	Stain Resistant				55"/56"	37.85	34.95
OMEGA 61160-82	100% Polyurethane Face 100% Polyester Knit Back; eco-tex [®]	WriteOut™ Ink Resistant				54"	33.75	30.95
ORION® 61920-33	100% Polyester; eco-tex [®]	Stain Resistant	Acrylic	5 3/4"	4 3/4"	54"	35.95	33.95
POLISHED 60740-69	100% Polyurethane Face 100% Polyester Back; eco-tex [®]	WipeOUT™ Stain Resistant Aegis Microbe Shield®				54"	39.95	36.95
PRISM 60210-46	100% Polyester	INCASE™ Stain Resistant	Acrylic			54"	23.25	21.50
RADIANT® 69280-87	100% Polyester; Reversible	Nano-Tex Stain Resistant		13"	Half Drop	14"	52.35	48.25
ROUNDABOUT® 60090-105	100% Post Consumer Recycled Polyester eco-tex [®]	GreenShield Stain Resistant		11 1/2"	7"	55"	33.50	30.75
SPIRIT 60460-92	100% Polyester	INCASE™ Stain Resistant	Acrylic			54"	29.75	26.50
SPYRO® 69900-09	65% Post Consumer Recycled Polyester/ 35% Polyester; eco-tex [®]	Greenshield Stain Resistant		12 1/2"	14"	54"	45.50	41.95
STREAMLINE 62070-82	100% Vinyl/ 100% Polyester Hi-Loft Back	AG SilverGuard™ PBG+ Stain Resistant		18"	Half Drop	18"	30.95	29.75
THEORY 60350-82	50% Post Consumer Recycled Polyester/ 50% Polyester; eco-tex [®]	Stain Resistant	Latex			54"	18.50	16.95

Panel

Name AC No.	Contents / Description	Finish	Backing	Approx. Vert. Repeat	Approx. Horiz. Repeat	Width	Cost - 99 Yds. & Less	Cost - 100 Yds. & More
VIBRATO® ¹ 68690-704	100% Recycled Polyester eco-tex®					60"	31.25	28.95

Reference Key

- 1 Phasing out (please check stock before specifying)
- 2 Selected colors phasing out (please check stock before specifying)
- Ⓡ Design is sampled railroaded

Cubicle

Name AC No.	Contents / Description	Approx. Vert. Repeat	Approx. Horiz. Repeat	Width	Cost - 99 Yds. & Less	Cost - 100 Yds. & More
AQUARIUS® 33030-37	100% FR Polyester	37 1/2" Half Drop	37"	74"	36.75	33.75
BROADLINE® 33020-24	100% FR Polyester (RxB)	28 3/4"	11 1/2"	74"	36.50	33.50
CANOPY® 32840-45	100% Avora FR® Polyester	22"	19"	72"	34.50	31.75
CANYON-X 33140X-51X	97% FR Polyester 3% X-static silver antimicrobial fiber	27"		72"	52.95	49.95
DAHLIA-X 33280X-87X	97% Recycled FR Polyester / 3% X-static silver antimicrobial fiber; eco-tex	66"	72"	72"	49.95	47.95
EBB-X 33300X-06X	97% Recycled FR Polyester / 3% X-static silver antimicrobial fiber; eco-tex	70"	72"	72"	49.95	47.95
FATHOM-X 33250X-57X	57% Recycled FR Polyester / 40% FR Polyester 3% X-static silver antimicrobial fiber; eco-tex	27 1/2"	36"	72"	52.95	47.95
FRACTAL-X 33330X-34X	97% Recycled FR Polyester / 3% X-static silver antimicrobial fiber; eco-tex	36"	72"	72"	51.95	49.95
HABITAT® 32850-54	100% Avora FR® Polyester	21"	19"	72"	33.25	30.50
JADE-X 33120X-31X	97% FR Polyester 3% X-static silver antimicrobial fiber	30"	18 1/2"	72"	50.95	47.95
JULEP® 32880-87	100% Avora FR® Polyester	22"	13 1/2"	72"	37.95	34.75
KOMICHI 33110-17	52% Post Consumer Recycled Polyester 48% FR® Polyester; eco-tex	36"	37"	74"	40.95	37.50
LANAI® 33060-64	100% FR Polyester	41 1/4"	18"	74"	36.75	33.75
LIANA® 32860-65	100% Avora FR® Polyester	12"	19"	72"	34.75	31.75
LUNAR-X 33160X-65X	97% FR Polyester 3% X-static silver antimicrobial fiber	31"	18 1/2"	72"	46.95	44.75
LUNARIA® 32890-97	100% Avora FR® Polyester	13"	13 1/2"	72"	37.95	34.75
MELODY-X 33320X-04X	97% Recycled FR Polyester / 3% X-static silver antimicrobial fiber; eco-tex	63"	72"	72"	51.95	49.95
MORI 33080-87	52% Post Consumer Recycled Polyester 48% FR® Polyester; eco-tex	17 1/2"	18"	74"	40.95	37.50
NAMI 33100-106	52% Post Consumer Recycled Polyester 48% FR® Polyester; eco-tex	45"	18"	74"	40.95	37.50
PAPILLION-X 33190X-96X	57% Recycled FR Polyester / 39% FR Polyester 4% X-static silver antimicrobial fiber	31"	18 1/2"	72"	47.75	45.25
PETAL-X 33310X-16X	97% Recycled FR Polyester / 3% X-static silver antimicrobial fiber; eco-tex	19"	72"	72"	51.95	49.95
RAIN FOREST® 33050-54	100% FR Polyester	54"	37"	74"	33.95	31.25
SANCTUARY® 33010-15	100% FR Polyester (RxB)	74"	94"	74"/75"	39.50	36.25
SAND DOLLAR-X 33260X-6X	57% Recycled FR Polyester / 40% FR Polyester 3% X-static silver antimicrobial fiber; eco-tex	35"	18"	72"	52.95	47.95
SEA PEARL-X 33240X-47X	57% Recycled FR Polyester / 40% FR Polyester 3% X-static silver antimicrobial fiber; eco-tex	24"	18"	72"	52.95	47.95
SEASCAPE® 33000-07	100% FR Polyester (RxB)	18 1/2" Half Drop	24"	72"	35.25	32.25
SENSU 33090-96	52% Post Consumer Recycled Polyester 48% FR® Polyester; eco-tex	18"	18"	74"	40.95	37.50
SHORELINE-X 33270X-78X	57% Recycled FR Polyester / 40% FR Polyester 3% X-static silver antimicrobial fiber; eco-tex	54"	72"	72"	52.95	47.95
SPARKLER® 32900-06	100% Avora FR® Polyester	35 1/2"	37 1/2"	72"	34.50	31.75
STRUCTURE-X 33290X-37X	97% Recycled FR Polyester / 3% X-static silver antimicrobial fiber; eco-tex	23"	72"	72"	49.95	47.95
SUPER MESH 31543	100% Nylon 1/2" Mesh Beige / Natural			20"	2.65	2.45
TIDAL STRIPE-X 33230X-38X	57% Recycled FR Polyester / 40% FR Polyester 3% X-static silver antimicrobial fiber; eco-tex		18"	72"	52.95	47.95

Cubicle

Name AC No.	Contents / Description	Approx. Vert. Repeat	Approx. Horiz. Repeat	Width	Cost - 99 Yds. & Less	Cost - 100 Yds. & More
TRADEWINDS® 33040-46	100% FR Polyester	42 ³ / ₄ "	37"	74"	36.75	33.50
TRANQUILITY® 33070-73	100% FR Polyester	52"	37"	74"	36.95	33.95
WOODLAND® 32760-64	100% Avora FR® Polyester	22 ¹ / ₂ "	18 ¹ / ₂ "	72"	36.95	33.75

All cubicle patterns can be manufactured as washable bedspreads. For information, contact our Customer Service Department or your Account Manager. Please visit www.arc-com.com for laundering instructions.

Reference Key

- 1 Phasing out (please check stock before specifying)
- 2 Selected colors phasing out (please check stock before specifying)

 Design is sampled railroaded

Wall Surfaces / Vinyl

Name AC No.	Contents / Description	Backing	Approx. Vert. Repeat	Approx. Horiz. Repeat	Finished Width	Net Contract Price	Cost Per Sq. Ft.
36 CANDLES® 55001-03	20 oz / Type II Vinyl	Polycotton Osnaburg	9"	9"	54"	18.95	1.40
ARABELLA 52191-204	20 oz / Type II Vinyl; eco-tex ®	Recycled Non Woven / 10% Post Consumer Recycled Content	12 5/8"	54"	54"	19.95	1.47
AKIRA® 52441-58	20 oz / Type II Vinyl; eco-tex ®	Recycled Woven Polycotton Osnaburg			54"	18.95	1.40
ARAGON® 51941-60	20 oz / Type II Vinyl; eco-tex ®	Recycled Woven Polycotton Osnaburg			52"	18.95	1.40
BAGATELLE® 55011-14	20 oz / Type II Vinyl	Non-Woven	9"	9"	54"	19.50	1.44
BERWICK® 52701-18	20 oz / Type II Vinyl; eco-tex ®	Recycled Woven Polycotton Osnaburg			54"	18.95	1.40
BOXWOOD® 51211-35	21 oz / Type II Vinyl	Polycotton Osnaburg			54"	17.95	1.33
BREYDEN 52281-104	20 oz / Type II Vinyl; eco-tex ®	Recycled Woven Polycotton Osnaburg			54"	17.95	1.33
BRUGE® 51311-34	21 oz / Type II Vinyl	Polycotton Osnaburg			54"	17.95	1.33
CAPELLA 52021-34	20 oz / Type II Vinyl; eco-tex ®	Recycled Non Woven / 10% Post Consumer Recycled Content	12 5/8"	54"	54"	19.95	1.47
CARNABY 52211-34	20 oz / Type II Vinyl; eco-tex ®	Recycled Woven Polycotton Osnaburg			54"	16.95	1.26
CERES® 52501-18	20 oz / Type II Vinyl	Polycotton Osnaburg			54"	17.95	1.33
CHIARA® 50781-94	20 oz / Type II Vinyl	Polycotton Osnaburg			54"	16.25	1.20
CHIARA STRIPE® 55021-23	20 oz / Type II Vinyl	Polycotton Osnaburg			54"	19.50	1.44
COURTRAE® 51350-73	20 oz / Type II Vinyl	Polycotton Osnaburg			54"	15.95	1.18
CUMULUS® 52531-57	20 oz / Type II Vinyl	Polycotton Osnaburg			54"	16.95	1.26
DAYNERYS® 52841-58	20 oz / Type II Vinyl; eco-tex ®	Recycled Woven Polycotton Osnaburg	5"		54"	18.95	1.40
EBBTIDE® 52251-68	20 oz / Type II Vinyl; eco-tex ®	Recycled Woven Polycotton Osnaburg			54"	17.95	1.33
ESTRADA® 51171-92	20 oz / Type II Vinyl	Polycotton Osnaburg			54"	15.95	1.18
ESTRADA ADDITIONS® 51193-210	20 oz / Type II Vinyl	Polycotton Osnaburg			54"	15.95	1.18
FENWICK® 50841-62	21 oz / Type II Vinyl	Polycotton Osnaburg			54"	17.25	1.28
FORLINO® 50031-49	20 oz / Type II Vinyl	Non-Woven	3"		54"	18.95	1.40
FREQUENCY 52001-14	20 oz / Type II Vinyl; eco-tex ®	Recycled Non Woven / 10% Post Consumer Recycled Content	25 1/4"	54"	54"	19.95	1.47
GIRASOLI® 55051-58	20 oz / Type II Vinyl	Polycotton Osnaburg			54"	18.95	1.40
HAMPTON 52401-22	21 oz / Type II Vinyl; eco-tex ®	Recycled Woven Polycotton Osnaburg			54"	18.95	1.40
KAMA® 52571-88	20 oz / Type II Vinyl	Polycotton Osnaburg			54"	19.95	1.47
KONA® 52741-55	20 oz / Type II Vinyl; eco-tex ®	Recycled Woven Polycotton Osnaburg			52"	18.95	1.40
LABYRINTH® 50701-27	21 oz / Type II Vinyl	Polycotton Osnaburg			54"	15.95	1.18
LANNISTER 52861-78	20 oz / Type II Vinyl; eco-tex ®	Recycled Woven Polycotton Osnaburg			54"	18.95	1.40
LECIRQUE 52771-83	20 oz / Type II Vinyl; eco-tex ®	Recycled Non Woven / 10% Post Consumer Recycled Content	25 1/4"	54"	54"	19.95	1.47
LUMIS 51741-64	20 oz / Type II Vinyl; eco-tex ®	Recycled Woven Polycotton Osnaburg			54"	18.95	1.40
LYONNE® 55081-84	20 oz / Type II Vinyl	Non-Woven	9"	13 1/2"	54"	19.50	1.44

Wall Surfaces / Vinyl

Name AC No.	Contents / Description	Backing	Approx. Vert. Repeat	Approx. Horiz. Repeat	Finished Width	Net Contract Price	Cost Per Sq. Ft.
MACHÉ 52371-88	20 oz / Type II Vinyl; eco-tex ®	Recycled Woven Polycotton Osnaburg			54"	17.95	1.33
MAGIQUE 52161-79	21 oz / Type II Vinyl; eco-tex ®	Recycled Non Woven / 10% Post Consumer Recycled Content	8 1/2"		54"	19.95	1.47
MAGNUM® 55091-93	20 oz / Type II Vinyl	Non-Woven	4 1/2"	4 1/2"	54"	19.50	1.44
MARRAKESH 52041-54	20 oz / Type II Vinyl; eco-tex ®	Recycled Non Woven / 10% Post Consumer Recycled Content	8 3/8"	50 1/2"	54"	19.95	1.47
MISTRAL 52631-48	20 oz / Type II Vinyl; eco-tex ®	Recycled Woven Polycotton Osnaburg			54"	18.95	1.40
MOHAVE 52111-30	20 oz / Type II Vinyl; eco-tex ®	Recycled Non Woven / 10% Post Consumer Recycled Content			54"	16.95	1.26
MONTEGO® 51081-100	21 oz / Type II Vinyl	Polycotton Osnaburg			54"	17.25	1.28
MONTEGO VINE® 55041-46	20 oz / Type II Vinyl	Non-Woven	18"	13 1/2"	54"	18.95	1.40
NEBULA 52061-74	20 oz / Type II Vinyl; eco-tex ®	Recycled Non Woven / 10% Post Consumer Recycled Content	12 5/8"	54"	54"	19.95	1.47
NIMBUS 51781-821	20 oz / Type II Vinyl; eco-tex ®	Recycled Woven Polycotton Osnaburg			52"	21.95	1.63
OPERA® 55101-03	20 oz / Type II Vinyl	Non-Woven	4 1/2"	4 1/2"	54"	19.50	1.44
OPTIX® 52601-18	20 oz / Type II Vinyl; eco-tex ®	Recycled Woven Polycotton Osnaburg			54"	18.95	1.40
PORTOFINO 51971-88	20 oz / Type II Vinyl; eco-tex ®	Recycled Woven Polycotton Osnaburg	35"		54"	18.95	1.40
QUADRILLE® 55031-37	21 oz / Type II Vinyl	Non-Woven	18"	27"	54"	19.50	1.44
RAKU® 52791-808	20 oz / Type II Vinyl; eco-tex ®	Recycled Woven Polycotton Osnaburg			54"	18.95	1.40
RAMI® 52311-28	21 oz / Type II Vinyl	Polycotton Osnaburg			54"	17.95	1.33
SAMOA® 50811-33	21 oz / Type II Vinyl	Polycotton Osnaburg			54"	17.95	1.33
SAVILE ROW 52341-70	20 oz / Type II Vinyl; eco-tex ®	Recycled Woven Polycotton Osnaburg			54"	16.95	1.26
SHANTUNG 51391-414	20 oz / Type II Vinyl; eco-tex ®	Recycled Non Woven / 10% Post Consumer Recycled Content			54"	15.95	1.18
SHANTUNG LOTUS 51431-42	20 oz / Type II Vinyl; eco-tex ®	Recycled Non Woven / 10% Post Consumer Recycled Content	24"	54"	54"	17.95	1.33
SHANTUNG SCROLL® 51451-62	20 oz / Type II Vinyl; eco-tex ®	Recycled Non Woven / 10% Post Consumer Recycled Content	18"	54"	54"	16.95	1.26
SHANTUNG STRIPE 51471-82	20 oz / Type II Vinyl; eco-tex ®	Recycled Non Woven / 10% Post Consumer Recycled Content		54"	54"	16.75	1.24
SOLI 52471-88	21 oz / Type II Vinyl; eco-tex ®	Recycled Non Woven / 10% Post Consumer Recycled Content			54"	18.95	1.40
ST BART'S® 55111-15	20 oz / Type II Vinyl	Polycotton Osnaburg	6"	4 1/2"	54"	18.95	1.40
STRIATIONS® 52661-82	20 oz / Type II Vinyl; eco-tex ®	Recycled Woven Polycotton Osnaburg			54"	18.95	1.40
SUMATRA® 50061-77	20 oz / Type II Vinyl	Polycotton Osnaburg			54"	16.95	1.26
TALIA STRIPE® 55151-53	21 oz / Type II Vinyl	Polycotton Osnaburg			54"	18.95	1.40
TANGIERS® 50361-86	20 oz / Type II Vinyl	Polycotton Osnaburg			54"	15.95	1.18
TANGIERS DAMASK® 50431-43	20 oz / Type II Vinyl	Non-Woven	18"		54"	17.95	1.33
TANGIERS STRIPE® 50401-13	20 oz / Type II Vinyl	Polycotton Osnaburg			54"	16.95	1.26
TESSERE 52081-104	21 oz / Type II Vinyl; eco-tex ®	Recycled Woven Polycotton Osnaburg			54"	17.95	1.33
VERGANO® 51285-96	20 oz / Type II Vinyl	Non-Woven			54"	16.95	1.26

Wall Surfaces / Vinyl

Name AC No.	Contents / Description	Backing	Approx. Vert. Repeat	Approx. Horiz. Repeat	Finished Width	Net Contract Price	Cost Per Sq. Ft.
VERGANO BURNISHED® 51281-84	20 oz / Type II Vinyl	Non-Woven			54"	18.95	1.40
WESTEROS® 52811-28	20 oz / Type II Vinyl; eco-tex ®	Recycled Woven Polycotton Osnaburg			54"	18.95	1.40
WILDFLOWER® 55071-73	21 oz / Type II Vinyl	Non-Woven	9"	13 1/2"	54"	19.50	1.44
ZEBRANO 52141-58	20 oz / Type II Vinyl; eco-tex ®	Recycled Non Woven / 10% Post Consumer Recycled Content			54"	17.95	1.33
ZEFERELLI® 55161-67	21 oz / Type II Vinyl	Polycotton Osnaburg			54"	18.95	1.40

Cut charge: Packaged in 30 yard bolts. Cut charge of \$3.00 per yard is applied to any order under 30 yards per color. No cut charge over 30 yards per color.

Return Policy: Only full, uncut bolts will be accepted for return with pre-authorization. 35% re-stocking fee; 45 days from date of invoice; maximum 300 yards per color. Applicable freight charges apply. No returns accepted on custom materials.

Wallcovering Permeability, Moisture and Mold: One of the characteristics of vinyl wallcovering is that it has little or no moisture permeability. This characteristic can be an important benefit in terms of durability, cleanability and wall protection. If the design, construction or maintenance of a building allows liquid or vapor moisture to accumulate in a wall or wall cavity, vinyl wallcovering can act as a vapor barrier restricting the escape of moisture and increasing the risk of mold growth. In all cases, moisture and sources of moisture accumulation must be eliminated before installing any wallcovering material. Vinyl wallcovering does contain additives to resist mold and other microbial growth on the product itself but these additives will not prevent mold growth.

Perforation/Microventing: Vinyl wallcovering permeability can be increased through perforation/microventing. Perforation/Microventing is available on a custom order basis, 30 yard minimum quantity per color, \$2.95 per yard additional cost.

Custom Digital Printed Wall Surfaces Design: Unique ability to create digitally printed wall surfaces designs, wall murals, art impressions, graphic images, photo murals, & logowall. Consult with your sales associate for the opportunity to explore and create digital wall surfaces.

General Information

Terms and Conditions

All prices contained herein are contract net prices in United States Dollars. There will be an export document charge for all Canadian and International shipments. Regular terms are Net 30 days from date of invoice. All invoices are dated the day of shipment. Regular terms do not apply to special pricing. Special pricing terms are Net 10 days from the date of the invoice. Prices shown in sample books may no longer be in effect and are subject to change without notice. All merchandise is shipped F.O.B. Orangeburg, or processing points. Applicable sales tax will be charged unless a resale certificate is on file at Arc-Com for the "ship to" state. No discounts are allowed on freight charges. Late payment charges of 1-1/2% per month, 18% per annum or the highest amount allowable by law will be applied to past due accounts. **To open a Net 30 Account**, fax a signed request along with the following information to the attention of the Credit Department; the name and address of five trade references, company bank information and resale number. If an open account has not been established, Proforma or CBD payment will be required for all orders. Deposits placed against purchase orders requiring partial shipments, will be applied proportionately to each shipment. Shipments requiring a specific delivery release schedule will be billed according to Arc-Com's policy of billing fabric as ready, regardless of when the shipment is released. No order will be accepted for less than one yard per pattern number. For orders other than cut yardage, Arc-Com reserves the right, within reasonable tolerances and in accordance with industry standards, to ship bolts closest in yardage to the actual purchase order requirement. Individual orders exceeding a maximum length of 108 inches, a maximum combined length plus girth of 165 inches, or the maximum actual weight of 150 pounds and not meeting the minimum requirement for transport carriers will be subject to an additional handling charge of \$50.00 as designated by both DHL and UPS. Arc-Com products are intended for use in the contract furnishings industry and not intended for use in the apparel industry. Textiles purchased to ship outside the United States may be subject to duty and taxes. Please contact Customer Service for additional information.

Applicable Laws

Arc-Com manufacturers and tests products for industry applicable standards and fire codes. Test results are available upon your request through our Customer Service Department. They may be used as guidelines for specifying individual products, but in no case should they be considered a guarantee.

If a test, standard or law on a federal, state, local or international level is required other than those that are listed as a part of the specifications outlined in our price list or on the product tag, you must advise us of the specific statute either before specifying it or by listing it on your purchase order under each individual line item so that we may test to see that the product complies. Additionally, we may be able to comply with your requirements using additional processes. In any case, we will confirm our results in written form.

Quality Control

Arc-Com examines all products. Manufacturers and fabricators should examine fabrics carefully before cutting to verify correct pattern, color and yardage. Arc-Com will not be responsible for any claim if fabric is cut. All Quality Control claims will be handled on an individual basis. Arc-Com sells its products without the knowledge of its end use and does not accept claims for any labor charges. Color samples must accompany purchase orders if a color match is requested. Arc-Com will advise as to its ability to comply. Variation in color cannot be avoided, as no two color lots are exactly the same. Arc-Com, as customary to the industry, reserves the right to substitute an alternate component having similar characteristics, without notice, if a raw material is unavailable for production.

Warranty

Arc-Com warrants that its products are manufactured in accordance with the Textile Fiber Products Identification Act. Arc-Com products meet or exceed the industry standards as defined by the Association for Contract Textile Guidelines (ACT). Our warranty is given expressly and in lieu of any and all other warranties either expressed or implied, including the warranties of merchantability and fitness for a particular purpose. **For detailed warranty information, please visit our website at www.arc-com.com.**

Returns

Requests to return fabric must be approved by Arc-Com. All returns are at the sole discretion of Arc-Com. Products approved for return will be issued a Return Authorization Number. A 35% restocking fee will be applied. For textiles, no orders of less than ten (10) yards will be accepted for return. For wallcoverings, no orders less than full pieces will be accepted for return. No return will be accepted on merchandise that has been cut, processed, or marked in any way. Fabric must be rolled on a tube as originally shipped. Special order fabric not regularly carried in stock may not be returned. All returns must be prepaid and include a return authorization number on the shipping label. No returns will be authorized beyond 60 days from date of shipment. Authorized returns must be received no later than 30 days from date of issue of a Return Authorization. Return Authorizations automatically expire 30 days from the date of issue.

Cancellation

Requests to cancel purchase orders must be made in writing. Each request will be considered on its own merit. Cancellations are not automatic and are valid only upon issuance of a cancellation number. Requests to place an existing order "on hold" are valid only upon issuance of an "on hold" authorization number.

General Information

Discontinued Items

Patterns that are being phased out or discontinued may be ordered if minimum yardage requirements are met and textile construction is available. Items not appearing in this price list may be available in limited quantities, or may be produced on a special order basis.

Placing an Order

To place an order, check stock or obtain additional information please contact your local Account Manager or Customer Service at 800-223-5466. Please include product name and number, color name and number, yardage requirement, name of firm originating specification and bill to and ship to address on all orders. This information can be faxed to your local showroom or Arc-Com Headquarters at 845-365-1285.

Credit Cards

Arc-Com accepts Visa, MasterCard and American Express. For additional information please contact the Credit Department.

Reserves

Reserves may be placed on product to assure prompt delivery. Reserves will be held for a maximum of five (5) business days and may be extended on the fifth day for an additional five (5) business days.



Samples

All samples remain the property of Arc-Com. Arc-Com reserves the right to update sample libraries or remove samples without prior notice.

Repeats / Railroaded

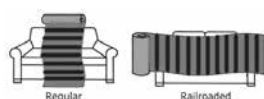
Pattern repeats vary. Repeats shown in price list and sample books are approximate. To avoid possible shortages, allowances should be made for all patterns with a repeat.



When  is displayed, it indicates that the pattern may be applied either vertically or horizontally. Example: If a stripe is woven side to side across the 54 inch width of a fabric, when  is affixed to it, it is a designation that the stripe is displayed and ticketed as a vertical stripe. When a jacquard pattern has  affixed it designates that the pattern is woven horizontally but ticketed and displayed as a vertical. When ordering fabric, instructions should accompany your order to the manufacturer as to the choice of direction of an application.

Copyrighted Designs

Arc-Com's designs are all copyrighted under U.S. and International copyright laws.

GSA Schedule

All drapery, cubicle, print and bedspread fabrics are available on GSA schedule. For information on how to specify our products on schedule, please contact our GSA administrator at our Orangeburg Headquarters location.

Primary Usage/Wallcovering Applications

Arc-Com lists its products alphabetically by the primary usage of the textile. Categories listed are Upholstery, Cubicle, Panel, and Wallcovering. Certain fabrics have been designed for multiple uses. Additional finishes may be required if the intended use of the fabric is not consistent with the primary use as designated herein. It is the purchaser's responsibility to determine code compliance for products used in any way other than the primary use as designated herein. With the exception of the wallcovering line, purchase orders for any products ordered for wall application, must be placed in writing and boldly marked "**For Wallcovering Application**". Arc-Com bears no responsibility for improperly marked purchase orders. Any problems arising from an improperly marked order for either product or labor will be the responsibility of the purchaser. To prevent potential installation problems, wallcovering applications should be reviewed with the installing contractor and your Arc-Com Account Manager prior to purchasing textiles. No credit memorandum will be issued for claims against product unless the Quality Control Department has examined the fabric and has determined a product defect exists.

Arc-Com Corporate Advantage® and Corporate Alliance Program®

Corporate Advantage and Corporate Alliance Programs are distinctive services designed to meet the needs of corporate end-users and furniture manufacturers. Corporate Advantage is a program tailored to assist Arc-Com's corporate end-users that provides a host of services including inventory reserve programs; dedicated customer service representatives; records of purchases by location; and guaranteed pricing. The Corporate Alliance Program is a partnering relationship with furniture manufacturers that facilitates the use of Arc-Com textiles on contract furniture. This program along with numerous Arc-Com grade-in programs, is promoted in conjunction with various furniture manufacturers.

Technical Services / COM Approvals

Technical Information

Fire code information is available in the form of a letter of certification from Arc-Com or certified test data from an independent testing facility. Test results are provided by Arc-Com solely as a guideline and are not to be construed as a guarantee. As test procedures and requirements may change, published test information may be invalid. For additional testing from an independent testing laboratory regarding a specific style number contact Customer Service. A purchase order will be required prior to testing and a fee will be quoted and charges applied.

Textile products, both natural and synthetic, are often treated during the spinning, dyeing, weaving and finishing processes. Proper consideration should be given to the general conditions relating to heat, humidity and ventilation waiting period necessary to aerate products before they are installed at the final destination.

Arc-Com products are sold without its knowledge of the end use or installation. Test results are provided by Arc-Com solely as a guideline and no guarantee or representations of any kind are made in such regard. If the intended application of product requires a specific test result, it may be possible for Arc-Com to provide a product that achieves the required test results. It is the purchaser's responsibility to advise Arc-Com in writing of any specific performance requirements at the time the order is placed. Contact Customer Service for further information.

Crypton® & Crypton®green

Arc-Com offers an extensive line of Woven Crypton® & Crypton® green high performance textiles for contract, healthcare, hospitality and institutional applications. Designed to maintain a soft comfortable hand, all Arc-Com Woven Cryptons® and Crypton® green fabrics are breathable, bacteria, stain and moisture resistant and meet extremely high durability standards. All Crypton® green fabrics are designed with a reduced environmental impact. All Arc-Com Crypton® and Crypton® green upholstery fabrics are noted in the price list. Please contact your local account representative or customer service for additional information or to inquire about custom Crypton® or Crypton® green patterns.

Seating COM Approvals

Arc-Com's fabrics are pre-approved for application on many furniture manufacturers' seating styles including a wide range of Steelcase, Haworth and Herman Miller products. A complete list of approvals is available by request from our Customer Service Department. Although Arc-Com continually updates this information, we recommend you verify COM approvals at the time of specification as these approvals are subject to change. Additional Arc-Com textiles can be tested at your request. Please contact your local Account Manager or our Customer Service Department.

Arc-Com textiles are also available through grade-in programs with various furniture manufacturers. Some of these manufacturers provide fabric cards with selected Arc-Com upholstery fabrics for your convenience and ease in specifying. A complete list of participating furniture manufacturers is available by request from our Customer Service Department. Manufacturers' cards featuring Arc-Com can be obtained from participating furniture suppliers.

System COM Approvals

Arc-Com panel fabrics are pre-approved for application on numerous manufacturers' furniture systems. A complete list of approvals is available by request from our Customer Service Department. Although Arc-Com continually updates this information, we recommend you verify COM approvals at the time of specification as these approvals are subject to change. Additional Arc-Com textiles can be tested at your request. Please contact your local Account Manager or our Customer Service Department with project name and all pertinent information.

Upholstery Cleaning Codes (Written instructions available upon request)

- S** Only mild pure water-free dry cleaning solvents may be used. Cleaning by a professional service is recommended.
- W** Clean only with water based shampoo or foam upholstery cleaner. Cleaning by a professional service is recommended.
- WS** Water based cleaning agents and foam may be used for cleaning. This fabric may also be cleaned with mild, water-free solvents. Cleaning by a professional service is recommended.

There are a variety of commercial chemical cleaners available on the market which should be scrutinized carefully as they may not be appropriate for woven textiles or coated products such as vinyl and polyurethane.

These products may come in liquid, wipes and spray bottles and may have some immediate positive results, however, over time there may be a filmy build up of the chemical and degradation of the product. This may not be apparent from your initial applications.

Please refer to the instructions of the manufacturers and note that many of these chemicals should be avoided on porous, soft surfaces. Refer to arc-com.com for product specific cleaning instructions.

Cubicle Curtain Laundering: Please visit www.arc-com.com for laundering instructions.

Special Processing

Overage Requirements

Due to working loss in all finishing processes, an additional 5% overage should be added to your original fabric requirement. For orders 15 yards and less we recommend you add 1 yard.



Nano-tex® Stain Resist Finish provides an invisible barrier that causes liquids to bead up and roll off textiles without penetrating the fibers. Liquids can be blotted off the face of the fabric to prevent staining. Fabric maintains its natural hand and breathability. Nano-tex® is environmentally friendly and recyclable. Nano-tex® can be applied to most Arc-Com fabrics, contact Customer Service at: 800-223-5466.

Nano-tex® Stain Resist (5 yard minimum)

5 - 73 yds: **\$215.00 minimum charge**
74+ yds: **\$2.95 per yd.**

DuraBlock™ Moisture Barrier (5 yard minimum)

Can be laminated to any textile that already has Nano-tex®. DuraBlock™ is a breathable barrier that prevents liquids from reaching the seat cushion. It is 100% antimony-free polyester and is recyclable. To add DuraBlock™ to fabric that already has Nano-tex®:

5 - 34 yds: **\$225.00 minimum charge**
35+ yds: **\$6.50 per yd.**

Nano-tex® and DuraBlock™ Combination (5 yard minimum)

5 - 31 yds: **\$250.00 minimum charge**
32+ yds: **\$8.00 per yd.**

Nano-Tex FR and Bio-Am® Antimicrobial Finish

Nano-Tex® FR can be added to any inherently flame resistant, cubicle fabric, such as 100% Trevira® CS, or FR Polyester. We recommend this be done in conjunction with our Bio-Am® Antimicrobial finish. Arc-Com offers a non-leaching antimicrobial that has been tested and proven effective against bacteria and microbes that can cause odor, staining, and deterioration commonly found in healthcare environments. Bio-Am® contains no phthalates, lead, triclosan, dioxins, arsenic, tin, heavy metals, biguanides, bischlorinated phenols or halogenated compounds. When applied to FR Polyester Cubicle fabrics, this finish is effective after 25 commercial launderings and is FR neutral to vertical flame tests. We recommend fabrics be treated with Nano-tex® Stain Resist in conjunction with Bio-Am®.

72" FR Cubicle Fabrics

Nano-tex® FR & Bio-Am® Combination

1 to 76 yds: **\$250.00 minimum charge**
77+ yds: **\$3.25 per yd.**



INCASE™ is an advanced stain and microbial resistant treatment, that works at the molecular level resulting in liquids immediately rolling away. INCASE™ allows both oil and water based stains to easily release from the fabric when cleaned. Only fabrics with no other finishes can be treated with INCASE™.

INCASE™ Fabric Protection (15 yard minimum)

\$2.75 per yd.

INCASE™ Fabric Protection FR (50 yard minimum)

\$3.50 per yd.

Special Processing



GreenShield® is an environmentally friendly stain resistant finish that provides superior water and oil repellency. GreenShield® uses a lower flourochemical content than most of the stain resistant technologies available in the market today. Only fabrics with no other finishes can be treated with GreenShield Stain Resist.

GreenShield® Stain Resist (10 yard minimum)
\$2.50 per yd.

Arc-Com Moisture Barrier (5 yard minimum)
 Recommended for use with fabrics that have INCASE™, GreenShield®, Teflon® & Generic Stain Resist finishes.
5 - 34 yds: \$225.00 minimum charge
35+ yds: \$6.50 per yd.



Fabrics treated for repellency fight off dry soil and nasty, unpredictable spills and splashes, allowing liquids to bead up and roll off. Liquid spills can easily be wiped away when blotted with a clean cloth, and dry soil can be brushed off easily.

Teflon® Stain Resist (Or equal to)
1 to 66 yds: \$100.00 minimum charge
67+ yds: \$1.50 per yd.

Acrylic Backing for Upholstery One Coat
1 to 80 yds: \$200.00 minimum charge
81+ yds: \$2.50 per yd.

One Coat Acrylic Backing with Teflon® Combination
1 to 57 yds: \$200.00 minimum charge
58+ yds: \$3.50 per yd.

Special Wallcovering Backing with Stain Resist Finish
 It is recommended that a special acrylic backing be applied when an upholstery fabric is being utilized as a wallcovering. These fabrics must also be treated with a stain resist finish:
1 to 50 yds: \$225.00 minimum charge
51+ yds: \$4.50 per yd.

Flameproofing



The fire code requirement, weight and content of a fabric relates directly to the price of flameproofing. Please confirm pricing before quoting a client. Most flameproofing treatments can withstand up to 20 dry cleanings without re-flameproofing.

Standard Flameproofing:
1 to 39 yards: \$125.00 minimum charge
40+ yards: \$3.25 per yd.

Flameproofing with Stain Release:
1 to 39 yards: \$150.00 minimum charge
40+ yards: \$4.00 per yd.

California Technical Bulletin 133

Only the furniture manufacturer can certify compliance with **California TB 133**. Fabric by itself or components can be tested or certified by the furniture manufacturer for use under the standards of California TB 133. Arc-Com can help you in attaining information and certification from the furniture manufacturer of your choice. Certain fabric can be treated to help pass TB 133 requirements. Please call Customer Service for assistance.

IMO

Arc-Com has many upholstery textiles that either pass IMO (International Maritime Organization) standards or when used with the appropriate components, can pass IMO standards. For other application, Arc-Com can alter fabric contents or treat fabrics to pass IMO. Please contact Customer Service for assistance.

Textiles Numerical Index

Cubicle

31542 SUPER MESH
 31543 SUPER MESH
 32610-14 NEW HORIZONS
 32690-97 VERANDA
 32700-07 ESPLANADE
 32710-17 TRELIS
 32720-27 PORTICO
 32730-35 SATORI
 32760-64 WOODLAND
 32770-77 NEPTUNE
 32780-85 ATLANTIS
 32840-45 CANOPY
 32850-54 HABITAT
 32860-65 LIANA
 32870-75 BON BON
 32880-87 JULEP
 32890-97 LUNARIA
 32900-06 SPARKLER
 33000-07 SEASCAPE
 33010-15 SANCTUARY
 33020-24 BROADLINE
 33030-37 AQUARIUS
 33040-46 TRADEWINDS
 33050-54 RAIN FOREST
 33060-64 LANAI
 33070-73 TRANQUILITY
 33080-87 MORI
 33090-96 SENSU
 33100-106 NAMI
 33110-17 KOMICHI
 33120X-31X JADE-X
 33140X-51X CANYON-X
 33160X-65X LUNAR-X
 33230X-38X TIDAL STRIPE-X
 33240X-47X SEA PEARL-X
 33250X-57X FATHOM-X
 33260X-66X SAND DOLLAR-X
 33270X-78X SHORELINE-X
 33280X-87X DAHLIA-X
 33290X-97X STRUCTURE-X
 33300X-06X EBB-X
 33310X-16X PETAL-X
 33320X-24X MELODY-X
 33330X-34X FRACTAL-X

Upholstery

60000-18 NOVA
 60020-33 CLARION
 60040-57 SHIBORI
 60060-69 NETWORK
 60070-84 ANTIGUA
 60090-105 ROUNDABOUT
 60110-24 SAHARA
 60130-65 CHROMA
 60170-85 GALAXY
 60190-201 MERIDIAN
 60210-46 PRISM
 60250-64 LEAFLET
 60270-88 SANTA FE
 60290-307 MARATHON
 60310-25 KIRIGAMI
 60330-47 GLIMMER
 60350-82 THEORY
 60390-407 CASABLANCA
 60410-24 MOROCCO
 60430-51 CIRQUE
 60460-92 SPIRIT
 60500-31 DYNASTY
 60540-57 RAVENNA
 60560-70 FACET
 60580-604 MOON BEAM 2
 60610-27 LUXE
 60630-42 SAMBA
 60650-62 LYRIC
 60670-77 PROVENCE
 60680-93 KINETIC
 60700-18 URBAN
 60720-30 METRO
 60740-69 POLISHED
 60770-83 CAMPUS STRIPE

60790-802
 60810-21
 60830-47
 60850-66
 60880-94
 60990-1000
 61010-24
 61030-47
 61070-85
 61090-107
 61110-29
 61130-36
 61140-54
 61160-82
 61190-204
 61210-35
 61240-55
 61260-72
 61280-92
 61300-12
 61320-32
 61340-56
 61360-70
 61380-87
 61390-400
 61410-32
 61440-51
 61460-71
 61480-90
 61500-10
 61520-30
 61540-51
 61580-84
 61590-603
 61610-15
 61620-43
 61650-75
 61680-85
 61690-701
 61710-21
 61730-50
 61760-72
 61780-92
 61800-10
 61840-52
 61860-83
 61890-912
 61920-33
 61940-55
 61960-73
 61980-98
 62000-11
 62020-28
 62050-63
 62070-82
 62090-108
 62110-36
 66150-69
 66520-29
 66530-52
 67170-77
 67250-60
 67380-97
 67400-19
 67480-504
 67530-55
 67560-601
 67650-69
 67720-27
 67750-61
 67770-96
 67910-17
 67970-81
 68030-42
 68050-58
 68090-98
 68100-11
 68120-31
 68140-49
 68150-65
 68210-17

ROBOTIC
 SPOT ON
 TALLY
 ISABELLA
 ANALOG
 MEADOW
 BLOOM
 ASTRAL
 DAZZLE
 CROSSROADS
 BOARDWALK
 VOLT
 RADIUS
 OMGEGA
 ALPHA
 PALATINE 2
 GRID
 KEY
 LYRE
 COLUMN
 DELPHI
 AXIS
 TECTONIC
 GAR DENIA
 SEQUOIA
 INTAGLIO 2
 COMPASS
 MIRROR MIRROR
 ARASHI
 KUMO
 KATANO
 ITAJIME
 APEX
 JIVE
 THE PLAID
 CHANNEL
 COASTLINE
 ZIP LINE
 DAKOTA 2
 VINEYARD
 HARLEQUIN
 SPIN
 ODYSSEY
 MASON
 CASCADE
 EMPRESS
 GAMMA
 ORION
 SHERLOCK
 HIGHLANDS
 VELOCITY
 SHIMMER 2
 AUORA
 CONTOUR
 STREAMLINE
 ILLUSION 2
 HUSH
 FRANCESCA WOOL
 FIREFLIES
 PEBBLE BEACH
 DIAMOND DERBY
 HOPSCOTCH
 TATAMI
 SUEDE SENSATION
 FRONTIER
 IGUANA
 DURANGO
 SILVERADO
 PINBALL
 BOUNCE
 POSH
 ROYAL GARDEN
 GEM
 FORSYTHIA
 TUSCANY
 BAUBLE
 CIRCUIT
 FRANCESCA WOOL II
 PARCHMENT
 ETCH
 PALA

68220-27
 68230-36
 68240-51
 68280-85
 68290-305
 68340-46
 68350-61
 68410-21
 68440-48
 68450-65
 68470-80
 68490-501
 68510-21
 68530-40
 68570-78
 68580-97
 68620-41
 68650-58
 68690-704
 68710-26
 68730-40
 68750-63
 68770-77
 68800-12
 68820-29
 68830-37
 68840-48
 68850-63
 68870-80
 68890-904
 68910-19
 68920-24
 68930-43
 68950-59
 68960-73
 69010-32
 69040-56
 69140-151
 69210-34
 69240-52
 69260-75
 69280-87
 69290-301
 69310-25
 69340-51
 69360-82
 69390-97
 69400-419
 69430-36
 69440-64
 69470-80
 69490-502
 69510-21
 69530-41
 69550-57
 69560-78
 69580-93
 69600-15
 69620-35
 69640-55
 69660-67
 69670-83
 69690-730
 69760-68
 69770-90
 69800-15
 69820-37
 69840-64
 69870-84
 69890-99
 69900-09
 69920-35
 69940-88

TANGO
 SAVANNAH
 BOURBON STREET
 SYMPHONY
 RHYTHM
 JARDIN
 JING
 PANACHE
 UPTOWN
 PALATINE
 STONEHENGE
 DUCHESS
 LANCASTER
 TRIO
 MASQUERADE
 ILLUSION
 MOON BEAM
 WONDERLAND
 VIBRATO
 MYSTIQUE
 STRAND-IT
 GRAND CENTRAL
 BEAT BOX
 SAGRADA
 ECLIPSE
 VOLLEY
 LOTUS
 STRATA
 RIVIERA
 SPOTLIGHT
 PINPOINT
 LEONARDO
 ALLEGRA
 CASSIO
 SPRING
 GATSBY
 OASIS
 YO-YO
 SHIMMER
 JULIET
 ETC.
 RADIANT
 CHIT-CHAT
 BUBBLY
 TEMPO
 BRONCO
 CARNIVAL
 INTAGLIO
 QUAD
 LEGACY
 BLOSSOM
 NAVIGATOR
 ECHO
 CANDY LAND
 FIORE
 INTERSECT
 NIAGARA
 LAUREL
 CONSTANTINE
 MONTE CARLO
 RINGLING
 BLOCK PARTY
 SPECTRUM
 POLO
 MURANO
 PLATEAU
 VISTA
 DELTA
 MESA
 TERRAIN
 SPYRO
 DAKOTA
 RODEO

Contact Info / Showrooms

Headquarters:

33 Ramland Road South
Orangeburg, NY 10962
t: 845.365.1100
www.arc-com.com email: inquiries@arc-com.com

Credit / Accounting:

t: 845.365.1100 f: 845.365.3648

Customer Service:

t: 800.223.5466 f: 845.365.1285 email: orders@arc-com.com

8:30am to 6:00pm EST (Monday-Thursday)

8:30am to 5:00pm EST (Friday)

To obtain a sample, check stock/delivery or place an order please contact Arc-Com Customer Service or one of the showrooms listed below.

Showrooms

Atlanta – Atlanta Decorative Arts Center

351 Peachtree Hills Ave. N.E., Suite 411
Atlanta, GA 30305
Tel (404) 233-0722, (800) 833-9288
Fax (678) 894-4163 ATLSHOWROOM@ARC-COM.COM

Boston

850 Summer St.
So. Boston, MA 02127
Tel (617) 268-1695
Fax (617) 268-1697 BOSTONSHOWROOM@ARC-COM.COM

Chicago

222 Merchandise Mart Plaza, Suite 1194
Chicago, IL 60654
Tel (312) 644-0680, (800) 644-8191
Fax (312) 644-0938 CHGOSHOWROOM@ARC-COM.COM

Dallas

The Decorative Center
1617 Hi Line., Suite 305
Dallas, TX 75207
Tel (214) 752-6933, (800) 378-1966
Fax (214) 752-6988 DALSHOWROOM@ARC-COM.COM

Houston – Houston Decorative Center

5120 Woodway, Suite 3019
Houston, TX 77056
Tel (713) 961-1537, (800) 876-9333
Fax (713) 961-5138 HOUSHOWROOM@ARC-COM.COM

Los Angeles

6420 Wilshire Boulevard, Suite 240
Los Angeles, CA 90048
Tel (323) 655-1255, (800) 228-7906
Fax (323) 655-1288 LASHOWROOM@ARC-COM.COM

New York City – New York Design Center

200 Lexington Avenue, Suite 1411
New York, NY 10016
Tel (212) 751-1590, (800) 361-9804
Fax (212) 751-2434 NYSHOWROOM@ARC-COM.COM

San Francisco – The San Francisco Design Center - Galleria

101 Henry Adams Street, Suite 325
San Francisco, CA 94103
Tel (415) 861-8600, (800) 853-6380
Fax (415) 861-0965 SFSHOWROOM@ARC-COM.COM

Toronto

310 Davenport Road, (Designer's Walk Lane Entrance)
Toronto, Ontario M5R 1K6 Canada
Tel (416) 923-4711, (877) 203-6940 (Canada only)
Fax (416) 923-7765 TORSHOWROOM@ARC-COM.COM

Washington, DC – Franklin Court

1099 14th St., N.W., Suite 450
Washington, DC 20005
Tel (202) 863-2900, (888) 365-0055
Fax (240) 293-4832 DCSHOWROOM@ARC-COM.COM

Local Sales Rep / Agent

To find your local sales rep or agent please visit:

www.arc-com.com/sales_reps



33 Ramland Road South
Orangeburg, NY 10962

t: 845.365.1100 800.223.5466
f: 845.365.1285 www.arc-com.com



**NET
PRICE
LIST**

February 01, 2016



102 Madison Avenue

New York, NY 10016

Phone: 212-686-6056

Toll Free: 800-621-5250

Fax: 212-686-6014

website: www.coralfabrics.com

e-mail: info@coralfabrics.com

Table Of Contents

Ordering Information	5
Processing Information	6
ACT Performance Standards	7
Upholstery Fabrics	8
Vinyl Upholstery	17
Barrier Upholstery	20
Outdoor Upholstery Fabrics	26
Eco Drapery	27
Drapery Alternate Ground Cloths	29
Drapery Fabrics	30
Drapery Linings	38
Cubicle Fabrics/Cubicle Mesh	39
Shower Curtains	41
Bedding Encasement Products	43
Limited Availability	45
Index - Alphabetical Listing Of Patterns	59

Ordering Information

Customer Service	Phone: (800) 621-5250 (212) 686-6056 Extension 4 Fax: (212) 686-6014 Website: www.CoralFabrics.com Email: info@coralfabrics.com Hours: 9:00 AM - 5:00 PM EST
Bolt Sizes	On bolt orders every effort will be made to ship close to the requested yardage. However, industry standards do allow for up to a 5% overage due to bolt sizes.
Memo Samples	Memo samples of all of CORAL'S patterns are available. For a quick view, or to request particular memo samples please visit our website www.coralfabrics.com or call or fax our New York office at 800-621-5250, fax 212-686-6014.
Cancellations	If you wish to cancel an order, each request will be examined on its own merit. You must be issued a cancellation number. In no case may a cancellation be assumed.
Care And Maintenance Instructions	Maintenance instructions are listed on the back of our sample books. If additional information is required please contact our Customer Service Department.
Color Matching	Fabrics should be examined carefully before cutting to verify that color and pattern are as ordered. Since no two print runs or dye lots can be color matched identically during processing, there is bound to be a slight amount of variation. We will however, always attempt to ship a satisfactory commercial match. Any fabric that is cut cannot be accepted for return. Should an exact match be required, please submit a cutting with your order.
Custom Capabilities	As is industry standard, custom products are sold by the bolt with a maximum overage of 10%. Production minimums vary, and developmental charges may apply . Please consult your local representative or the Coral Customer Service Department for complete details.
Returns	Returns are not acceptable without Return Authorization. Reasonable requests for returns must be received within 30 days of invoice. There will be a 25% restocking charge plus freight charges, unless the fault is Coral's. Merchandise authorized for return must be received within 30 days. Credit will not be issued unless the fabric is received within 30 days from the date of authorization. If return is not received within 30 days, authorization is immediately revoked. Absolutely no cancellation or return on materials which have been specially processed, fabricated or custom ordered. Under no circumstances will cuts of less than 15 yards be accepted for return. Returns will not be accepted if shipped to our New York Office.
Terms and Conditions	Terms are net 30 day upon Factor approval. No discounts are allowed on freight or sales taxes. Applicable sales taxes are charged unless a resale card is on file at Coral. It is against our policy to accept claims for any labor charges. Price subject to change without notice. Freight: FOB Spartanburg, SC or points of processing. Not responsible for typographical errors.

Processing Information

Acrylic Backing with Soil & Stain Repellent Finish	In order to add an acrylic backing, all fabrics must be treated with a Stain Repellent Finish The below prices reflect both processes. Upholstery 1-50 yards \$200.00 min. 50+ yards \$4.00 per yard
Anti-Microbial Finish with Nanotex Stain Repellent	The combination of Nanotex / Anti-microbial Immersion Finish resists the development and growth of a wide range of bacteria and fungi while protecting against water and oil-based stains and airborne dirt. \$4.00 per yard or \$200.00 min.
Anti-Microbial Finish with Moisture Barrier	Our Anti-Microbial Moisture Barrier is a product that we can laminate to the under side of most of our fabrics for protection against fluids penetrating into the cushion. It contains specific agents effective against many bacterial and fungal microorganisms. \$9.00 per yard - 1 piece /50 yards min.
Upholstery Fabric Fire Barrier Treatment	Most of our upholstery fabrics can be processed with a fire barrier treatment. This treatment will eliminate the double upholstery process required when a fire barrier fabric is being used. Upholstery fabrics when processed with the fire barrier treatment, and used in combination with other compatible furniture components, have been shown to perform well under the fire test conditions of the California Bulletin 133. Information regarding the upholstery fabrics recommended to be Fire Barrier treated can be obtained through the Customer Service Department.
Flame Retardant Treatment	Flame retardant treatment or immersion of a fabric in a special chemical bath renders most fabrics flame resistant. 10 yard minimum. Drapery Treatment 10-59 yards \$300.00 min. 60 yards+ \$3.50 per yard Drapery NFPA 701 Certification - \$300 Upholstery Treatment 10-50 yards \$300.00 min. (NFPA 260 or MVSS-302) 50 yards+ \$4.00 per yard *Check with customer service if fabric can be successfully treated.
Soil & Stain Repellent Treatment	Generic Soil & Stain treatment or Nanotex Treatment 1-50 yards \$200.00 min. 50+ yards \$3.00 per yard

A.C.T. Performance Standards

ACT has developed the following Performance Guidelines to make fabric specification easier. The 5 symbols give architects, designers, and end-users a vast amount of performance information in a concise visual way. The test method for each icon is explained below.

Please contact your Coral Customer Service Team for an ACT Performance Guide.



Flame Resistance refers to a fabric's ability to resist burning.

Upholstery California Bulletin 117 Section E Direct Glue Wall coverings ASTM E 84 (adhered method) Panels and Upholstered Walls ASTM E 84 (unadhered method) Drapery N.F.P.A. 701 Small Scale - 2004 Edition



Colorfastness is a fabric's ability to retain color in various conditions. Crocking refers to the rubbing off of color from a fabric when subjected to abrasion.

Upholstery AATCC 8 Dry Crocking, Class 4 minimum Wet Crocking, Class 3 minimum

Direct Glue Wall coverings AATCC 8, Class 3 minimum Panels and Upholstered Walls AATCC 8, Class 3 minimum Drapery AATCC 8 (solids), AATCC 116 (prints), Class 3 minimum



Colorfastness to light refers to a fabric's ability to resist fading when exposed to light.

Upholstery AATCC 16A or AATCC 16E, Class 4 minimum at 40 hours Direct Glue Wall coverings AATCC 16A or AATCC 16E, Class 4 minimum at 40 hours Panels and Upholstered Walls AATCC 16A or AATCC 16E, Class 4 minimum at 40 hours Drapery AATCC 16A or AATCC 16E, Class 4 minimum at 60 hours



Pilling is the formation of fuzzy balls on the surface of the fabric. Pilling occurs when loose fibers in the fabric are worked to the surface after the fabric is subjected to abrasion.

Breaking Strength measures a fabric's ability to resist tearing or breaking when subjected to tension.

Seam Slippage refers to the condition when fabrics pull apart at a sewn seam.

Upholstery Brush Pill ASTM D3511, Class 3 minimum Breaking Strength ASTM D3597-D 1682-64, 50 lbs. minimum in warp and weft Seam Slippage ASTM D3597-D434, 25 lbs. minimum in warp and weft

Panels and Breaking Strength D5034 Grab Method, 35 lbs. minimum in warp and weft Upholstered Walls Seam Slippage ASTM 3597-434, 25 lbs. minimum in warp and weft

Drapery Seam Slippage ASTM D3597-434 for fabrics over 6 oz. / sq. yard, 25 lbs. minimum in warp and weft Seam Slippage ASTM D3597-434 for fabrics under 6 oz. / sq. yard, 15 lbs. minimum in warp and weft



Abrasion resistance is the ability of a fabric to withstand surface wear from rubbing.

Upholstery ASTM D4966 (21 oz. weight) 20,000 rubs Martindale method



Heavy Duty Upholstery ASTM D4157-02 modified (#10 cotton duck) 30,000 double rubs Wyzenbeek method ASTM D4966 (21 oz. weight) 40,000 rubs Martindale method

Upholstery Fabrics



*Our Crypton prints are available on all of our drapery weight print ground cloths for a minimum of one piece. Please call your local representative or the New York Office for assistance.

Pattern Name	Width	Product Data	Repeat (Inches)	Cut Price	Bolt Price
Anchor-C	54 "	100% Solution Dyed Acrylic	9 H	\$26.95	\$21.95
Artisanal-C/U	54 "	100% Polyester FR Blend / Nanotex & Acrylic Backing	None	\$32.95	\$23.95
Bagatelle	54 "	52% Solution Dyed Nylon/48% H.E. Polyester / Nanotex-Durablock	2 V / 1.75 H	\$36.50	\$31.50
Barrier Reef-C	54 "	100% Bella Dura Olefin	13.5 V / 13.5 H	\$35.45	\$30.45
Bauble-C/U	54 "	100% Polyester FR Blend / Nanotex & Acrylic Backing	1.5 V / 1.5 H	\$32.95	\$23.95
Beach Club-C	54 "	100% Bella Dura Olefin	1.75 V / 1.75 H	\$35.45	\$30.45
Beachcomber	54 "	56% H.E. Dyed Polyester/44% Solution Dyed Nylon / Nanotex-Durablock	7.25 V / 7.25 H (RR)	\$42.50	\$36.50
Bellaire	54 "	57% H.E. Dyed Polyester/43% Solution Dyed Nylon / Nanotex-Durablock	3.5 V / 3.5 H (RR)	\$42.95	\$37.95
Biltmore-C/U	54 "	100% Polyester FR Blend / Nanotex & Acrylic Backing	3.5 V / 1 H	\$32.95	\$23.95
Blossom-C/U	54 "	100% Polyester FR Blend / Nanotex & Acrylic Backing	13.5 V / 13.5 H	\$32.95	\$23.95
Bodhi Leaves	54 "	57% H.E. Dyed Polyester/43% Solution Dyed Nylon / Nanotex-Durablock	14.5 V / 14.5 H (RR)	\$47.95	\$42.95
Bonanza	54 "	52% H.E. Dyed Polyester/48% Solution Dyed Nylon / Nanotex-Durablock	6.75 H (RR)	\$38.95	\$33.95
Botany	54 "	56% High Energy Dyed Polyester/44% Solution Dyed Nylon/Nanotex Durablock	14.25 V / 14.5 H	\$41.50	\$36.50
Cache-C	54 "	52% Acrylic/40% Polyester/8% Rayon/Soil/Stain Finish and Acrylic Backing	None	\$31.95	\$26.95
Carlina-C	54 "	62% Rayon - 38% Polyester / Acrylic Backing / Soil And Stain Repellent Finish	13.5 V / 13.5 H (RR)	\$32.95	\$27.95
Caterina-C	54 "	54% Acrylic - 46% Polyester / Acrylic Backing / Soil And Stain Repellent Finish	13.5 V / 12.75 H (RR)	\$32.45	\$27.45
Celebrate -C	54 "	100% Polyester	None	\$35.95	\$30.95
Celia-C	54 "	43% Polyester - 38% Rayon - 19% Cotton / Acrylic Backing / Soil And Stain Repellent Finish	6.75 V / 7 H (RR)	\$39.95	\$34.95
Chancery-C/U	54 "	100% Polyester FR Blend / Nanotex & Acrylic Backing	None	\$32.95	\$23.95
Cinema - C	54 "	100% Polyester	None	\$35.95	\$30.95
Cinzia-C	59 "	100% Recycled Polyester / Acrylic Backing / Soil And Stain Repellent Finish	5 V / 5.36 H (RR)	\$34.95	\$29.95
Clara-C	54 "	67% Rayon - 33% Recycled Polyester / Acrylic Backing / Soil And Stain Repellent Finish	0 V / 2.75 H (RR)	\$36.95	\$31.95
Coco-C	54 "	78% Polyester - 22% Recycled Polyester / Acrylic Backing / Soil And Stain Repellent Finish	0.5 V / 0.5 H (RR)	\$34.95	\$29.95

Upholstery Fabrics



*Our Crypton prints are available on all of our drapery weight print ground cloths for a minimum of one piece. Please call your local representative or the New York Office for assistance.

Pattern Name	Width	Product Data	Repeat (Inches)	Cut Price	Bolt Price
Cole-C	54 "	57% Polyester-22% Rayon-14% Acrylic-7% Cotton / Acrylic Backing / Soil And Stain Repellent Finish	3.375 V / 13.125 H (RR)	\$34.95	\$29.95
Comfy-C	54 "	100% Polyester / Polyester Cotton Backing	None	\$23.50	\$19.50
Compass-C/U	54 "	100% Polyester FR Blend / Nanotex & Acrylic Backing	None	\$0.00	\$23.95
Cosima-C	54 "	100% Recycled Polyester / Acrylic Backing / Soil And Stain Repellent Finish	2.25 V / 6.5 H (RR)	\$32.45	\$27.45
Cozumel-C	54 "	100% Bella Dura Olefin/Soil & Stain	20 V / 18.5 H	\$37.95	\$32.95
Cozy-C	54 "	100% Polyester / Polyester Cotton Backing	None	\$23.00	\$19.00
Crest-C	54 "	100% Bella Dura Olefin/Soil & Stain	8.5 V / 3.5 H	\$36.95	\$31.95
Cuddly-C	54 "	100% Polyester	None	\$30.95	\$25.95
Dock-C	54 "	100% Bella Dura Olefin/Soil & Stain	1.5 V / 1 H (RR)	\$33.95	\$28.95
Eastwood-C	54 "	100% Polyester/Poly Knit backing	None	\$18.45	\$14.45
Edison-C	54 "	66.2% Polyester/32.93% Rayon/65% Nylon	None	\$29.95	\$24.95
Einstein-C	54 "	57% Acrylic, 43% Polyester/latex backing	None	\$26.95	\$21.95
El Yunque-C/U	54 "	100% Polyester FR Blend / Nanotex & Acrylic Backing	None	\$0.00	\$23.95
Elite-C	54 "	53% Poly, 47% Acrylic/acrylic backing	None	\$33.95	\$28.95
Empire-C	54 "	100% Polyester	None	\$25.95	\$20.95
Equinox-C	54 "	52% Polyester - 41% Acrylic - 7% Rayon/acrylic backing	None	\$29.95	\$24.95
Escape-C	54 "	100% Bella Dura Olefin/Soil and Stain	1.6 V / 9 H	\$33.95	\$28.95
Estate-C	54 "	87% Polyester, 13% Viscose/Acrylic backing	None	\$26.95	\$21.95
Eureka-C/U	54 "	100% Polyester FR Blend / Nanotex & Acrylic Backing	None	\$32.95	\$23.95
Extinct-C/U	54 "	100% Polyester FR Blend / Nanotex & Acrylic Backing	None	\$0.00	\$23.95
Gaelic	54 "	100% Recycled Polyester / Crypton	2.38 V / 2.25 H (RR)	\$41.95	\$36.95
Gamma	54 "	100% Recycled Polyester / Crypton	7.13 V / 9.5 H (RR)	\$42.95	\$37.95
Garden	54 "	100% Recycled Polyester/ Crypton	14.5 V / 13.5 H (RR)	\$54.45	\$49.45
Geode	54 "	100% Recycled Polyester / Crypton	7.5 V / 8.38 H (RR)	\$42.45	\$37.45
Google	54 "	60% Recycled Polyester - 40% Polyester/ Crypton	14.5 V / 29 H (RR)	\$51.45	\$46.45
Gracious	54 "	100% Recycled Polyester / Crypton	1 H (RR)	\$41.45	\$36.45
Green Tea	54 "	100% Recycled Polyester / Crypton	3.63 V / 3.25 H (RR)	\$42.45	\$37.45
Greenlight	54 "	100% Recycled Polyester / Crypton	7.5 V / 3 H (RR)	\$46.45	\$41.45
Groovy	54 "	60% Recycled Polyester - 40% Polyester/ Crypton	7.5 V / 12 H (RR)	\$51.45	\$46.45
Horizons-C	54 "	100% Bella Dura Olefin/Soil & Stain	14 V / 11.5 H (RR)	\$43.95	\$38.95

Upholstery Fabrics



*Our Crypton prints are available on all of our drapery weight print ground cloths for a minimum of one piece. Please call your local representative or the New York Office for assistance.

Pattern Name	Width	Product Data	Repeat (Inches)	Cut Price	Bolt Price
Illustrious-C/U	54 "	100% Polyester FR Blend / Nanotex & Acrylic Backing	None	\$0.00	\$23.95
Island Breeze-C	54 "	100% Bella Dura Olefin/Soil & Stain Finish	21.12 V / 12.75 H	\$35.95	\$30.95
Jackpot-C	54 "	54% Polyester - 46% Recycled Polyester / Acrylic Backing / Soil And Stain Repellent Finish	3.5 V / 4.25 H (RR)	\$30.95	\$25.95
Jamboree-C	54 "	59% Polyester - 41% Rayon / Acrylic Backing / Soil And Stain Repellent Finish	None	\$30.45	\$25.45
Jazz-C	54 "	65% Polyester - 24% Cotton - 11% Rayon / Acrylic Backing / Soil And Stain Repellent Finish	None	\$22.95	\$18.95
Jersey-C	54 "	100% Polyester / Acrylic Backing / Soil And Stain Repellent Finish	None	\$23.95	\$19.95
Jitterbug-C	54 "	100% Polyester / Acrylic Backing / Soil And Stain Repellent Finish	6.75 H (RR)	\$32.95	\$27.95
Jolie-C	54 "	100% Polyester / Acrylic Backing / Soil And Stain Repellent Finish	None	\$30.95	\$25.95
Journey-C	54 "	85% Olefin - 15% Polyester / Acrylic Backing / Soil And Stain Repellent Finish	None	\$29.95	\$24.95
Jovial-C	54 "	100% Polyester / Acrylic Backing / Soil And Stain Repellent Finish	None	\$27.45	\$22.45
Lansing-C	54 "	100% Polyester / Acrylic Backing / Soil And Stain Repellent Finish	None	\$26.95	\$22.95
Laurel-C	54 "	37% Acrylic - 35% Polyester - 28% Cotton / Acrylic Backing / Soil And Stain Repellent Finish	None	\$29.45	\$24.45
Leland-C	54 "	65% Polyester - 35% Acrylic / Acrylic Backing / Soil And Stain Repellent Finish	None	\$29.95	\$24.95
Lenox-C	54 "	45% Cotton - 30% Rayon - 25% Polyester / Acrylic Backing / Soil And Stain Repellent Finish	None	\$32.45	\$27.45
Lockport-C	54 "	46% Polyester - 34% Cotton - 20% Acrylic / Acrylic Backing / Soil And Stain Repellent Finish	None	\$30.95	\$25.95
Lowell-C	54 "	100% Polyester / Acrylic Backing	None	\$30.45	\$25.45
Loxley-C	54 "	69% Polyester - 31% Cotton / Acrylic Backing / Soil And Stain Repellent Finish	None	\$29.95	\$24.95
Maguire U-C	54 "		None	\$0.00	\$21.95
Maze-C/U	54 "	100% Polyester FR Blend / Nanotex & Acrylic Backing	2 V / 2.75 H	\$32.95	\$23.95
Merry-C/U	54 "	100% Polyester FR Blend / Nanotex & Acrylic Backing	None	\$0.00	\$23.95
Nature-C	54 "	41% Cotton - 35% Polyester - 23% Rayon - 1% Nylon/Acrylic Backing / Soil And Stain Repellent Finish	14.5 V / 18.75 H (RR)	\$24.45	\$20.45
Network-C	54 "	100% Polyester/Acrylic Backing / Soil And Stain Repellent Finish	3.75 V / 2.75 H (RR)	\$28.45	\$23.45

Upholstery Fabrics



*Our Crypton prints are available on all of our drapery weight print ground cloths for a minimum of one piece. Please call your local representative or the New York Office for assistance.

Pattern Name	Width	Product Data	Repeat (Inches)	Cut Price	Bolt Price
Nifty-C	54 "	57% Polyester - 43% Recycled Polyester/Acrylic Backing / Soil And Stain Repellent Finish	2.25 H (RR)	\$27.45	\$22.45
Nitro-C	54 "	66% Cotton - 34% Polyester/Acrylic Backing / Soil And Stain Repellent Finish	0.75 H (RR)	\$23.45	\$19.45
Nobility-C	54 "	100% Polyester/Acrylic Backing / Soil And Stain Repellent Finish	None	\$33.45	\$28.45
Nocturne-C	54 "	91% Recycled Polyester - 9% Polyester/Acrylic Backing / Soil And Stain Repellent Finish	0.375 V / 0.375 H (RR)	\$29.45	\$24.45
Northern-C	54 "	51% Recycled Polyester - 49% Polyester/Acrylic Backing / Soil And Stain Repellent Finish	3.75 V / 5 H	\$29.45	\$24.45
Notable-C	54 "	82% Polyester - 18% Recycled Polyester/Acrylic Backing / Soil And Stain Repellent Finish	5 V / 5 H (RR)	\$30.45	\$25.45
Nouveau-C	54 "	100% Polyester/Acrylic Backing / Soil And Stain Repellent Finish	None	\$30.45	\$25.45
Novella-C	54 "	53% Polyester - 47% Cotton/Acrylic Backing / Soil And Stain Repellent Finish	7.5 V / 7.5 H (RR)	\$30.45	\$25.45
Nuclear-C	54 "	46% Recycled Polyester - 32% Cotton - 22% Rayon/Acrylic Backing / Soil And Stain Repellent Finish	14.25 V / 8.75 H (RR)	\$28.45	\$23.45
Palatial-C/U	54 "	100% Polyester FR Blend / Nanotex & Acrylic Backing	None	\$0.00	\$23.95
Parade	54 "	100% Polyester / Crypton	None	\$38.50	\$33.50
Parallel	54 "	100% Polyester / Crypton	None	\$35.45	\$30.45
Patio	54 "	100% Polyester / Crypton	None	\$40.95	\$35.95
Pioneer	54 "	100% Polyester / Crypton	None	\$38.95	\$33.95
Poetic	54 "	100% Polyester / Crypton	None	\$33.45	\$28.45
Poolside-C	54 "	100% Bella Dura Olefin	0.25 V / 8.75 H (RR)	\$34.45	\$29.45
Portico	54 "	100% Polyester / Crypton	None	\$37.45	\$32.45
Precision-C/U	54 "	100% Polyester FR Blend / Nanotex & Acrylic Backing	2.25 H	\$32.95	\$23.95
Pueblo	54 "	100% Polyester / Crypton	None	\$33.95	\$28.95
Puka Shells-C	54 "	63% Solution Dyed Acrylic/37% Solution Dyed Polyester/Soil & Stain finish	14.2 V / 14.46 H	\$42.95	\$37.95
Purity	54 "	100% Polyester / Crypton	None	\$35.45	\$30.45
Ray-C	54 "	100% Solution Dyed Acrylic	3.38 V	\$32.95	\$27.95
Redding	54 "	100% Polyester / Crypton	None	\$30.95	\$25.95
Relax-C	54 "	100% Bella Dura Olefin/Soil & Stain Finish	27.85 V / 13.5 H	\$36.95	\$31.95
Reno	54 "	100% Polyester / Crypton	None	\$31.95	\$26.95
Reston	54 "	100% Polyester / Crypton	None	\$30.45	\$25.45

Upholstery Fabrics



*Our Crypton prints are available on all of our drapery weight print ground cloths for a minimum of one piece. Please call your local representative or the New York Office for assistance.

Pattern Name	Width	Product Data	Repeat (Inches)	Cut Price	Bolt Price
Rhinebeck	54 "	100% Polyester / Crypton	None	\$33.45	\$28.45
Richmond	54 "	100% Polyester / Crypton	None	\$28.45	\$23.45
Riverside	54 "	100% Polyester / Crypton	None	\$30.45	\$25.45
Rochester	54 "	100% Polyester / Crypton	None	\$33.45	\$28.45
Rockville	54 "	100% Polyester / Crypton	None	\$27.45	\$22.45
Roxbury	54 "	100% Polyester FR / Crypton	None	\$24.95	\$19.95
* Salerno (On Serenade PFP)	58 "	100% Polyester FR Hybrid / Crypton	9 V / 10.75 H	\$24.95	\$20.95
* Salute (On Serenade PFP)	58 "	100% Polyester FR Hybrid / Crypton	25 V / 27 H	\$24.95	\$20.95
* Samantha (On Serenade PFP)	58 "	100% Polyester FR Hybrid / Crypton	None	\$24.95	\$20.95
* Sanborn (On Serenade PFP)	58 "	100% Polyester FR Hybrid / Crypton	None	\$24.95	\$20.95
Sandbar-C	54 "	100% Bella Dura Olefin	None	\$38.95	\$33.95
Sargeant Stripe-C/U	54 "	100% Polyester FR Blend / Nanotex & Acrylic Backing	None	\$0.00	\$23.95
Savina	55 "	76% Recycled Polyester - 24% Cotton/Crypton	0.75 V / 0.438 H (RR)	\$41.45	\$36.45
* Savvy (On Serenade PFP)	58 "	100% Polyester FR Hybrid / Crypton	6 V / 6 H (RR)	\$24.95	\$20.95
Schooner-C	54 "	100% Solution Dyed Acrylic	4.5 H	\$30.95	\$25.95
Sensuous-C	54 "	100% Polyester / Stain Repellent	None	\$19.50	\$15.50
* Sentino (On Serenade PFP)	58 "	100% Polyester FR Hybrid / Crypton	18 V / 18 H	\$24.95	\$20.95
* Sentry (On Serenade PFP)	58 "	100% Polyester FR Hybrid / Crypton	None	\$24.95	\$20.95
Serafina	54 "	96% Recycled Polyester/4% Rayon/Crypton	13.5 V / 9.25 H (RR)	\$37.95	\$32.95
* Serene (On Serenade PFP)	58 "	100% Polyester FR Hybrid / Crypton	12.5 V / 13.5 H (RR)	\$24.95	\$20.95
Seurat-C/U	54 "	100% Polyester FR Blend / Nanotex & Acrylic Backing	None	\$0.00	\$23.95
* Shadowbox (On Serenade PFP)	58 "	100% Polyester FR Hybrid / Crypton	18 V / 13.5 H (RR)	\$24.95	\$20.95
* Shepherd (On Serenade PFP)	58 "	100% Polyester FR Hybrid / Crypton	25 V / 25 H	\$24.95	\$20.95
Shoreline-C	54 "	100% Solution Dyed Acrylic	None	\$24.45	\$20.45
* Sidebar (On Serenade PFP)	58 "	100% Polyester FR Hybrid / Crypton	9 V / 18.5 H	\$24.95	\$20.95
Silvia	54 "	76% Recycled Polyester - 22% Rayon - 2% Metal / Crypton	15 V / 9.2 H (RR)	\$37.95	\$32.95
Simona	58 "	100% Recycled Polyester/Crypton	2.31 V / 2.31 H (RR)	\$42.45	\$37.45
Skipper-C	54 "	100% Solution Dyed Acrylic	None	\$39.95	\$34.95
* Skywalk (On Serenade PFP)	58 "	100% Polyester FR Hybrid / Crypton	7.25 V / 7.25 H	\$24.95	\$20.95
* Slattery (On Serenade PFP)	58 "	100% Polyester FR Hybrid / Crypton	None	\$24.95	\$20.95
Sofia	54 "	100% Polyester/Crypton	None	\$41.95	\$36.95
Soho-C/U	54 "	100% Polyester FR Blend / Nanotex & Acrylic Backing	7 V / 7 H	\$32.95	\$23.95
* Soloist (On Serenade PFP)	58 "	100% Polyester FR Hybrid / Crypton	9 V / 9 H (RR)	\$24.95	\$20.95

Upholstery Fabrics



*Our Crypton prints are available on all of our drapery weight print ground cloths for a minimum of one piece. Please call your local representative or the New York Office for assistance.

Pattern Name	Width	Product Data	Repeat (Inches)	Cut Price	Bolt Price
Sonia	54 "	41% Polyester/ 30% Cotton/ 29% Rayon/Crypton	13.5 V / 13 H (RR)	\$43.45	\$38.45
Sonic	54 "	51% Acrylic/49% Polyester/Crypton	16.75 V / 14.5 H (RR)	\$32.45	\$27.45
* Sophora (On Serenade PFP)	58 "	100% Polyester FR Hybrid / Crypton	13.5 V / 27 H	\$24.95	\$20.95
Sparkle	54 "	57% Polyester-22% Rayon-14% Acrylic-7% Cotton / Crypton	3.375 V / 13.125 H (RR)	\$36.95	\$31.95
* Springwood (On Serenade PFP)	58 "	100% Polyester FR Hybrid / Crypton	18.5 V / 15.75 H (RR)	\$24.95	\$20.95
Starry Nite-C	54 "	100% Solution Dyed Acrylic	1.15 V / 1.65 H	\$33.95	\$28.95
Stefania	54 "	40% Polyester/ 37% Cotton/ 23% Rayon/Crypton	4.5 V / 11.5 H (RR)	\$38.95	\$33.95
* Steward (On Serenade PFP)	58 "	100% Polyester FR Hybrid / Crypton	0.88 V / 0.88 H	\$24.95	\$20.95
Sublime-C/U	54 "	100% Polyester FR Blend / Nanotex & Acrylic Backing	None	\$0.00	\$23.95
Sunny Days-C	54 "	100% Solution Dyed Acrylic	4.5 H	\$26.95	\$21.95
Susana	54 "	59% Cotton/ 41% Polyester/Crypton	1.66 V / 1.13 H (RR)	\$36.45	\$31.45
Tetris-C	54 "	50% Polyester - 43% Acrylic - 7% Rayon	9 V / 7 H (RR)	\$31.45	\$26.45
Thistle-C	54 "	50% Polyester - 43% Acrylic - 7% Rayon / Arylic Backing / Soil And Stain Repellent Finish	26.5 V / 14 H (RR)	\$31.45	\$26.45
Titan-C	54 "	54% Polyester - 39% Acrylic - 7% Rayon / Arylic Backing / Soil And Stain Repellent Finish	None	\$26.45	\$21.45
Toledo-C	54 "	55% Polyester - 38% Acrylic - 7% Rayon / Arylic Backing / Soil And Stain Repellent Finish	5 H (RR)	\$27.45	\$22.45
Treasure- C	54 "	47% Polyester - 46% Acrylic -7% Rayon / Arylic Backing / Soil And Stain Repellent Finish	0.75 H (RR)	\$29.45	\$24.45
Trianon-C/U	54 "	100% Polyester FR Blend / Nanotex & Acrylic Backing	None	\$0.00	\$23.95
Vacation-C	54 "	100% Polyurethane Face/100% Polyester Backing	None	\$49.95	\$44.95
Vaggio	54 "	100% PVC Face / 100% Brushed Polyester Knit Backing / Resilience Finish	None	\$21.70	\$17.70
Valencia	54 "	100% PVC Face / 100% Polyester Knit Backing	None	\$26.95	\$22.95
Valentine	54 "	100% PVC Face / Polyester Cotton Blend Backing	None	\$34.95	\$29.95
Valet	54 "	100% Polyurethane / 100% Polyester Knit Backing / Cleangene Finish	None	\$40.95	\$35.95
Valiant	54 "	100% Polyurethane Face / 100% Polyester Knit Backing	None	\$43.95	\$38.95
Valid	54 "	100% PVC Face / Polyester Cotton Blend Backing	None	\$34.95	\$29.45
Valise-C	54 "	100% PVC Face/100% Polyester Backing	None	\$24.95	\$20.95

Upholstery Fabrics



*Our Crypton prints are available on all of our drapery weight print ground cloths for a minimum of one piece. Please call your local representative or the New York Office for assistance.

Pattern Name	Width	Product Data	Repeat (Inches)	Cut Price	Bolt Price
Valley	54 "	100% Virgin Vinyl Face / Polyester Rayon Blend Backing	None	\$18.95	\$14.95
Valone	54 "	100% PVC Face / 100% Brushed Polyester Knit Backing / Resilience Finish	None	\$21.70	\$17.70
Valor	54 "	100% PVC Face / Polyester Cotton Blend Backing	None	\$34.95	\$29.45
Value	54 "	100% PVC Face / Polyester Cotton Blend Backing	None	\$34.95	\$29.45
Vancouver	54 "	100% PVC Face / 100% Polyester Backing	9.75 V / 9.75 H	\$44.95	\$39.95
Vane	54 "	100% Polyurethane Face / 100% Polyester Knit Backing / Cleangene Finish	None	\$40.95	\$35.95
Vanguard	54 "	100% Polyurethane Face / 100% Polyester Knit Back/ink resistant finish	None	\$34.95	\$29.95
Vanicia	54 "	100% PVC Face / 100% Brushed Polyester Knit Backing / Resilience Finish	None	\$22.20	\$18.20
Vanish	54 "	100% PVC Face / 100% Polyester Backing	9 V / 9 H	\$26.95	\$21.95
Vanity	54 "	100% PVC Face / Polyester Cotton Blend Backing	None	\$34.45	\$29.45
Vantage-C	54 "	100% PVC Face/100% Polyester Back	None	\$24.95	\$20.95
Varsity	54 "	100% PVC Face/100% Polyester Back	None	\$29.95	\$24.95
Vassal	54 "	Vinyl with Polyurethane Top Coat	17.25 V / 17.875 H	\$34.95	\$31.95
Vector	54 "	100% PVC Face / 100% Polyester Backing	9 V / 9 H	\$26.95	\$21.95
Velocity	54 "	100% PVC Face / 100% Polyester Knit Backing	None	\$26.95	\$22.95
Venture	54 "	100% PVC Face / Polyester Cotton Blend Backing	None	\$34.95	\$29.45
Venue	54 "	100% PVC Face / Polyester Cotton Blend Backing	None	\$34.95	\$29.45
Verbana	54 "	100% Polyurethane	None	\$37.95	\$32.95
Verdi	54 "	100% Polyurethane	None	\$45.95	\$40.95
Verdict	20 "	100% Polyurethane Face / 100% Polyester Knit Back/ink resistant finish	None	\$34.95	\$29.95
Verity	54 "	100% Polyurethane Face / 100% Polyester Backing	None	\$27.95	\$22.95
Verse	54 "	100% Polyurethane / 100% Polyester Knit Backing / Cleangene Finish	None	\$40.95	\$35.95
Vevell	54 "	100% PVC Face / 100% Polyester Backing	None	\$28.95	\$23.95
Vex	54 "	100% Polyurethane Face / 100% Polyester Knit Back/ink resistant finish	8 V / 8 H	\$34.95	\$29.95
Vexing	54 "	100% PVC Face / 100% Polyester Backing	None	\$27.95	\$22.95
Vibe	54 "	100% PVC Face/100% Polyester Back	None	\$24.95	\$20.95
Vibrant	54 "	100% PVC Face / 100% Brushed Polyester Knit Backing / Resilience Finish	None	\$24.95	\$20.95

Upholstery Fabrics



*Our Crypton prints are available on all of our drapery weight print ground cloths for a minimum of one piece. Please call your local representative or the New York Office for assistance.

Pattern Name	Width	Product Data	Repeat (Inches)	Cut Price	Bolt Price
Viceroy-C	54 "	100% PVC Face / 100% Polyester Back	None	\$29.95	\$24.95
Victory	54 "	100% PVC Face / 100% Brushed Polyester Knit Backing / Resilience Finish	None	\$24.95	\$20.95
Video	54 "	100% PVC Face / 100% Polyester Backing	None	\$24.95	\$20.95
Vienna	54 "	100% PVC Face / Polyester/Cotton Knit Backing	None	\$33.95	\$28.95
View	54 "	100% Polyurethane / 100% Polyester Knit Backing / Cleangene Finish	None	\$40.95	\$35.95
Vigil	54 "	100% Polyurethane / 100% Polyester Knit Backing / Cleangene Finish	None	\$40.95	\$35.95
Viletta	54 "	100% PVC Face / 100% Brushed Polyester Knit Backing / Resilience Finish	None	\$24.70	\$20.70
Villa	54 "	100% Polyurethane / 100% Polyester Knit Backing / Cleangene Finish	None	\$39.95	\$34.95
Village	54 "	100% PVC Face / 100% Polyester Backing	None	\$29.95	\$24.95
Vineyard-C	54 "	100% PVC Face / 100% Polyester Backing	None	\$22.95	\$18.95
Vintage	54 "	100% PVC Face/100% Polyester Back	None	\$24.95	\$20.95
Virtual	54 "	100% PVC Face / 100% Brushed Polyester Knit Backing / Resilience Finish	None	\$24.45	\$20.45
Visit	54 "	100% PVC Face	None	\$34.95	\$29.45
Vista	54 "	100% PVC Face / 100% Polyester Backing	15.5 V / 17.5 H	\$45.95	\$40.95
Visual	54 "	100% PVC Face / 100% Polyester back	None	\$20.70	\$16.70
Vital	54 "	100% PVC Face / 100% Polyester Backing	None	\$26.95	\$21.95
Vivid	54 "	100% Polyurethane Face / 100% Polyester Knit Back/ink resistant finish	None	\$34.95	\$29.95
Vlade	54 "	100% PVC Face / Polyester Rayon Blend Backing	None	\$27.95	\$22.95
Vocal	54 "	100% PVC Face / 100% Polyester Back	None	\$26.95	\$21.95
Vogue	54 "	100% Polyurethane / 100% Polyester Knit Backing / Cleangene Finish	None	\$40.95	\$35.95
Volley	54 "	100% PVC Face / 100% Polyester Knit Backing	None	\$26.95	\$22.95
Volman	54 "	100% PVC Face / Polyester Rayon Blend Backing	None	\$27.95	\$22.95
Volpe	54 "	100% PVC Face / Polyester Rayon Blend Backing	None	\$29.95	\$24.95
Vortex	54 "	100% Polyurethane Face / 100% Polyester Knit Back/ink resistant finish	None	\$34.95	\$29.95
Vow	54 "	100% Polyurethane Face / 100% Polyester Knit Back/ink resistant finish	8 V / 8 H	\$29.95	\$24.95
Voyage	54 "	100% PVC Face/100% Polyester Back	None	\$33.95	\$28.95
Vrignon	54 "	100% PVC Face / 100% Polyester Backing	None	\$27.95	\$22.95
Waltz	54 "	100% Polyester / Crypton	1.5 H (RR)	\$34.95	\$29.95

Upholstery Fabrics



*Our Crypton prints are available on all of our drapery weight print ground cloths for a minimum of one piece. Please call your local representative or the New York Office for assistance.

Pattern Name	Width	Product Data	Repeat (Inches)	Cut Price	Bolt Price
Wanderer	54 "	100% Polyester/Crypton Barrier	None	\$34.95	\$29.95
Wannabee	54 "	54% Acrylic - 47% Polyester / Crypton	7.25 V / 8.5 H (RR)	\$34.95	\$29.95
Waveband	54 "	54% Recycled Polyester - 46% Polyester / Crypton	5 V / 6 H (RR)	\$35.95	\$30.95
Website	54 "	100% Polyester / Crypton	2.5 V / 3.5 H (RR)	\$33.95	\$28.95
Welcome	54 "	95% Poly/3% Post ind Recy/2% Post Con Rec Poly/Crypton Barrier	None	\$35.95	\$30.95
Whisper	54 "	100% Polyester / Crypton	23.5 V / 14.25 H	\$42.95	\$37.95
Wilshire-C/U	54 "	100% Polyester FR Blend / Nanotex & Acrylic Backing	None	\$0.00	\$23.95
Wish	54 "	62% Poly/38% Recycled Poly/Crypton Barrier	None	\$41.95	\$36.95
Wonder	54 "	53%Poly/16% Post Con Rec/31% Post Ind. Rec/Crypton Barrier	None	\$41.45	\$36.45
Zany-C/U	54 "	100% Polyester FR Blend / Nanotex & Acrylic Backing	13.5 V / 13.5 H	\$32.95	\$23.95

Vinyl Upholstery



Pattern Name	Width	Product Data	Repeat (Inches)	Cut Price	Bolt Price
Vacation-C	54 "	100% Polyurethane Face/100% Polyester Backing	None	\$49.95	\$44.95
Vaggio	54 "	100% PVC Face / 100% Brushed Polyester Knit Backing / Resilience Finish	None	\$21.70	\$17.70
Valencia	54 "	100% PVC Face / 100% Polyester Knit Backing	None	\$26.95	\$22.95
Valentine	54 "	100% PVC Face / Polyester Cotton Blend Backing	None	\$34.95	\$29.95
Valet	54 "	100% Polyurethane / 100% Polyester Knit Backing / Cleangene Finish	None	\$40.95	\$35.95
Valiant	54 "	100% Polyurethane Face / 100% Polyester Knit Backing	None	\$43.95	\$38.95
Valid	54 "	100% PVC Face / Polyester Cotton Blend Backing	None	\$34.95	\$29.45
Valise-C	54 "	100% PVC Face/100% Polyester Backing	None	\$24.95	\$20.95
Valley	54 "	100% Virgin Vinyl Face / Polyester Rayon Blend Backing	None	\$18.95	\$14.95
Valone	54 "	100% PVC Face / 100% Brushed Polyester Knit Backing / Resilience Finish	None	\$21.70	\$17.70
Valor	54 "	100% PVC Face / Polyester Cotton Blend Backing	None	\$34.95	\$29.45
Value	54 "	100% PVC Face / Polyester Cotton Blend Backing	None	\$34.95	\$29.45
Vancouver	54 "	100% PVC Face / 100% Polyester Backing	9.75 V / 9.75 H	\$44.95	\$39.95
Vane	54 "	100% Polyurethane Face / 100% Polyester Knit Backing / Cleangene Finish	None	\$40.95	\$35.95
Vanguard	54 "	100% Polyurethane Face / 100% Polyester Knit Back/ink resistant finish	None	\$34.95	\$29.95
Vanicia	54 "	100% PVC Face / 100% Brushed Polyester Knit Backing / Resilience Finish	None	\$22.20	\$18.20
Vanish	54 "	100% PVC Face / 100% Polyester Backing	9 V / 9 H	\$26.95	\$21.95
Vanity	54 "	100% PVC Face / Polyester Cotton Blend Backing	None	\$34.45	\$29.45
Vantage-C	54 "	100% PVC Face/100% Polyester Back	None	\$24.95	\$20.95
Varsity	54 "	100% PVC Face/100% Polyester Back	None	\$29.95	\$24.95
Vassal	54 "	Vinyl with Polyurethane Top Coat	17.25 V / 17.875 H	\$34.95	\$31.95
Vector	54 "	100% PVC Face / 100% Polyester Backing	9 V / 9 H	\$26.95	\$21.95
Velocity	54 "	100% PVC Face / 100% Polyester Knit Backing	None	\$26.95	\$22.95
Venture	54 "	100% PVC Face / Polyester Cotton Blend Backing	None	\$34.95	\$29.45
Venue	54 "	100% PVC Face / Polyester Cotton Blend Backing	None	\$34.95	\$29.45
Verbana	54 "	100% Polyurethane	None	\$37.95	\$32.95
Verdi	54 "	100% Polyurethane	None	\$45.95	\$40.95

Vinyl Upholstery



Pattern Name	Width	Product Data	Repeat (Inches)	Cut Price	Bolt Price
Verdict	20 "	100% Polyurethane Face / 100% Polyester Knit Back/ink resistant finish	None	\$34.95	\$29.95
Verity	54 "	100% Polyurethane Face / 100% Polyester Backing	None	\$27.95	\$22.95
Verse	54 "	100% Polyurethane / 100% Polyester Knit Backing / Cleangene Finish	None	\$40.95	\$35.95
Vevell	54 "	100% PVC Face / 100% Polyester Backing	None	\$28.95	\$23.95
Vex	54 "	100% Polyurethane Face / 100% Polyester Knit Back/ink resistant finish	8 V / 8 H	\$34.95	\$29.95
Vexing	54 "	100% PVC Face / 100% Polyester Backing	None	\$27.95	\$22.95
Vibe	54 "	100% PVC Face/100% Polyester Back	None	\$24.95	\$20.95
Vibrant	54 "	100% PVC Face / 100% Brushed Polyester Knit Backing / Resilience Finish	None	\$24.95	\$20.95
Viceroy-C	54 "	100% PVC Face / 100% Polyester Back	None	\$29.95	\$24.95
Victory	54 "	100% PVC Face / 100% Brushed Polyester Knit Backing / Resilience Finish	None	\$24.95	\$20.95
Video	54 "	100% PVC Face / 100% Polyester Backing	None	\$24.95	\$20.95
Vienna	54 "	100% PVC Face / Polyester/Cotton Knit Backing	None	\$33.95	\$28.95
View	54 "	100% Polyurethane / 100% Polyester Knit Backing / Cleangene Finish	None	\$40.95	\$35.95
Vigil	54 "	100% Polyurethane / 100% Polyester Knit Backing / Cleangene Finish	None	\$40.95	\$35.95
Viletta	54 "	100% PVC Face / 100% Brushed Polyester Knit Backing / Resilience Finish	None	\$24.70	\$20.70
Villa	54 "	100% Polyurethane / 100% Polyester Knit Backing / Cleangene Finish	None	\$39.95	\$34.95
Village	54 "	100% PVC Face / 100% Polyester Backing	None	\$29.95	\$24.95
Vineyard-C	54 "	100% PVC Face / 100% Polyester Backing	None	\$22.95	\$18.95
Vintage	54 "	100% PVC Face/100% Polyester Back	None	\$24.95	\$20.95
Virtual	54 "	100% PVC Face / 100% Brushed Polyester Knit Backing / Resilience Finish	None	\$24.45	\$20.45
Visit	54 "	100% PVC Face	None	\$34.95	\$29.45
Vista	54 "	100% PVC Face / 100% Polyester Backing	15.5 V / 17.5 H	\$45.95	\$40.95
Visual	54 "	100% PVC Face / 100% Polyester back	None	\$20.70	\$16.70
Vital	54 "	100% PVC Face / 100% Polyester Backing	None	\$26.95	\$21.95
Vivid	54 "	100% Polyurethane Face / 100% Polyester Knit Back/ink resistant finish	None	\$34.95	\$29.95
Vlade	54 "	100% PVC Face / Polyester Rayon Blend Backing	None	\$27.95	\$22.95
Vocal	54 "	100% PVC Face / 100% Polyester Back	None	\$26.95	\$21.95
Vogue	54 "	100% Polyurethane / 100% Polyester Knit Backing / Cleangene Finish	None	\$40.95	\$35.95

Vinyl Upholstery



Pattern Name	Width	Product Data	Repeat (Inches)	Cut Price	Bolt Price
Volley	54 "	100% PVC Face / 100% Polyester Knit Backing	None	\$26.95	\$22.95
Volpe	54 "	100% PVC Face / Polyester Rayon Blend Backing	None	\$29.95	\$24.95
Vortex	54 "	100% Polyurethane Face / 100% Polyester Knit Back/ink resistant finish	None	\$34.95	\$29.95
Vow	54 "	100% Polyurethane Face / 100% Polyester Knit Back/ink resistant finish	8 V / 8 H	\$29.95	\$24.95
Voyage	54 "	100% PVC Face/100% Polyester Back	None	\$33.95	\$28.95
Vrigon	54 "	100% PVC Face / 100% Polyester Backing	None	\$27.95	\$22.95

Barrier Upholstery

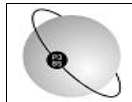

Crypton®, Fail Safe® and Nanotex + Durablock are revolutionary, technologically advanced fabric systems which involve special finishes and preparation. The technology adds protective features to fabrics while still retaining their original texture, surface characteristics, breathable comfort and hand. These Barrier fabrics are engineered for high performance; they feature excellent stain resistance, a total moisture barrier, anti-bacterial protection, strength and durability, a luxurious texture and the ability to meet upholstery flammability requirements. Beautiful and luxurious, yet miraculously strong and durable, Crypton®, Fail Safe® and Nanotex + Durablock fabrics are among the most versatile, and practical, fabrics ever created. They solve design problems, will stay clean, and last longer than any other textile you've ever used.

Please note that any of our in-line upholstery fabrics can be treated with the Nanotex + Durablock finish to make the fabric a moisture barrier product.

Featuring:



Alternate Crypton® Ground Cloths ...

Crypton® print designs, denoted by an asterisk (*) on the pages following, are available from stock on their upholstery "host base cloth" or any of our alternate Crypton® print cloths. The minimum order required for a change in base cloth is 5 yards. Please contact your sales representative or Customer Service for additional information.

Serenade 16 Ounces per linear yard, 54" wide, 100% Polyester textured "Linen" weave. Permanently encased yarns in Crypton® copolymer formula. Engineered for stain, moisture, and bacteria repellency. Cleanable with powdered enzyme detergent, and water. Tough and flexible. Durability to 100,000 double rubs on the Wyzenbeek ASTM D 3597 abrasion test with cotton duck. Complies with the California Bulletin 117 Section E, UFAC Class 1, NFPA 260. FR specifications. Recommended for upholstery applications.

Titanium 12 Ounces per linear yard, 54" wide, 100% Polyester textured crepe weave. Permanently encased yarns in Crypton® copolymer formula. Engineered for stain, moisture and bacteria repellency. Cleanable with powdered enzyme detergent and water. Tough and flexible. Exceeds 100,000 double rubs on the Wyzenbeek ASTM D 3597 abrasion test with cotton duck. Complies with the California Technical Bulletin 117 Section E, UFAC Class 1, NFPA 260. FR specifications. Recommended for upholstery applications.

U. S. Patents 5,565,265 & 5,747,392 & 6,024,823 and 6,165,920. Other U. S. and Foreign Patents Pending CRYPTON® is a Registered Trademark of Hi-Tex, Inc.

Performance Barrier Upholstery
QUALITY ASSURED ECO FRIENDLY

Barrier Upholstery

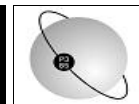

*Our Crypton prints are available on all of our drapery weight print ground cloths for a minimum of one piece. Please call your local representative or the New York Office for assistance.

Pattern Name	Width	Product Data	Repeat (Inches)	Cut Price	Bolt Price
Bagatelle	54 "	52% Solution Dyed Nylon/48% H.E. Polyester / Nanotex-Durablock	2 V / 1.75 H	\$36.50	\$31.50
Beachcomber	54 "	56% H.E. Dyed Polyester/44% Solution Dyed Nylon / Nanotex-Durablock	7.25 V / 7.25 H (RR)	\$42.50	\$36.50
Bellaire	54 "	57% H.E. Dyed Polyester/43% Solution Dyed Nylon / Nanotex-Durablock	3.5 V / 3.5 H (RR)	\$42.95	\$37.95
Bodhi Leaves	54 "	57% H.E. Dyed Polyester/43% Solution Dyed Nylon / Nanotex-Durablock	14.5 V / 14.5 H (RR)	\$47.95	\$42.95
Bonanza	54 "	52% H.E. Dyed Polyester/48% Solution Dyed Nylon / Nanotex-Durablock	6.75 H (RR)	\$38.95	\$33.95
Botany	54 "	56% High Energy Dyed Polyester/44% Solution Dyed Nylon/Nanotex Durablock	14.25 V / 14.5 H	\$41.50	\$36.50
Gaelic	54 "	100% Recycled Polyester / Crypton	2.38 V / 2.25 H (RR)	\$41.95	\$36.95
Gamma	54 "	100% Recycled Polyester / Crypton	7.13 V / 9.5 H (RR)	\$42.95	\$37.95
Garden	54 "	100% Recycled Polyester/ Crypton	14.5 V / 13.5 H (RR)	\$54.45	\$49.45
Geode	54 "	100% Recycled Polyester / Crypton	7.5 V / 8.38 H (RR)	\$42.45	\$37.45
Google	54 "	60% Recycled Polyester - 40% Polyester/ Crypton	14.5 V / 29 H (RR)	\$51.45	\$46.45
Gracious	54 "	100% Recycled Polyester / Crypton	1 H (RR)	\$41.45	\$36.45
Green Tea	54 "	100% Recycled Polyester / Crypton	3.63 V / 3.25 H (RR)	\$42.45	\$37.45
Greenlight	54 "	100% Recycled Polyester / Crypton	7.5 V / 3 H (RR)	\$46.45	\$41.45
Groovy	54 "	60% Recycled Polyester - 40% Polyester/ Crypton	7.5 V / 12 H (RR)	\$51.45	\$46.45
Parade	54 "	100% Polyester / Crypton	None	\$38.50	\$33.50
Parallel	54 "	100% Polyester / Crypton	None	\$35.45	\$30.45
Patio	54 "	100% Polyester / Crypton	None	\$40.95	\$35.95
Pioneer	54 "	100% Polyester / Crypton	None	\$38.95	\$33.95
Poetic	54 "	100% Polyester / Crypton	None	\$33.45	\$28.45
Portico	54 "	100% Polyester / Crypton	None	\$37.45	\$32.45
Pueblo	54 "	100% Polyester / Crypton	None	\$33.95	\$28.95
Purity	54 "	100% Polyester / Crypton	None	\$35.45	\$30.45
Redding	54 "	100% Polyester / Crypton	None	\$30.95	\$25.95
Reno	54 "	100% Polyester / Crypton	None	\$31.95	\$26.95
Rhinebeck	54 "	100% Polyester / Crypton	None	\$33.45	\$28.45
Richmond	54 "	100% Polyester / Crypton	None	\$28.45	\$23.45
Riverside	54 "	100% Polyester / Crypton	None	\$30.45	\$25.45
Rochester	54 "	100% Polyester / Crypton	None	\$33.45	\$28.45
Rockville	54 "	100% Polyester / Crypton	None	\$27.45	\$22.45
Roxbury	54 "	100% Polyester FR / Crypton	None	\$24.95	\$19.95

Barrier Upholstery

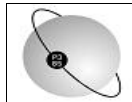

*Our Crypton prints are available on all of our drapery weight print ground cloths for a minimum of one piece. Please call your local representative or the New York Office for assistance.

Pattern Name	Width	Product Data	Repeat (Inches)	Cut Price	Bolt Price
* Salerno (On Serenade PFP)	58 "	100% Polyester FR Hybrid / Crypton	9 V / 10.75 H	\$24.95	\$20.95
* Salute (On Serenade PFP)	58 "	100% Polyester FR Hybrid / Crypton	25 V / 27 H	\$24.95	\$20.95
* Samantha (On Serenade PFP)	58 "	100% Polyester FR Hybrid / Crypton	None	\$24.95	\$20.95
Savina	55 "	76% Recycled Polyester - 24% Cotton/Crypton	0.75 V / 0.438 H (RR)	\$41.45	\$36.45
* Savvy (On Serenade PFP)	58 "	100% Polyester FR Hybrid / Crypton	6 V / 6 H (RR)	\$24.95	\$20.95
* Sentino (On Serenade PFP)	58 "	100% Polyester FR Hybrid / Crypton	18 V / 18 H	\$24.95	\$20.95
* Sentry (On Serenade PFP)	58 "	100% Polyester FR Hybrid / Crypton	None	\$24.95	\$20.95
Serafina	54 "	96% Recycled Polyester/4% Rayon/Crypton	13.5 V / 9.25 H (RR)	\$37.95	\$32.95
* Serene (On Serenade PFP)	58 "	100% Polyester FR Hybrid / Crypton	12.5 V / 13.5 H (RR)	\$24.95	\$20.95
* Shadowbox (On Serenade PFP)	58 "	100% Polyester FR Hybrid / Crypton	18 V / 13.5 H (RR)	\$24.95	\$20.95
* Shepherd (On Serenade PFP)	58 "	100% Polyester FR Hybrid / Crypton	25 V / 25 H	\$24.95	\$20.95
* Sidebar (On Serenade PFP)	58 "	100% Polyester FR Hybrid / Crypton	9 V / 18.5 H	\$24.95	\$20.95
Silvia	54 "	76% Recycled Polyester - 22% Rayon - 2% Metal / Crypton	15 V / 9.2 H (RR)	\$37.95	\$32.95
Simona	58 "	100% Recycled Polyester/Crypton	2.31 V / 2.31 H (RR)	\$42.45	\$37.45
* Skywalk (On Serenade PFP)	58 "	100% Polyester FR Hybrid / Crypton	7.25 V / 7.25 H	\$24.95	\$20.95
* Slattery (On Serenade PFP)	58 "	100% Polyester FR Hybrid / Crypton	None	\$24.95	\$20.95
Sofia	54 "	100% Polyester/Crypton	None	\$41.95	\$36.95
* Soloist (On Serenade PFP)	58 "	100% Polyester FR Hybrid / Crypton	9 V / 9 H (RR)	\$24.95	\$20.95
Sonia	54 "	41% Polyester/ 30% Cotton/ 29% Rayon/Crypton	13.5 V / 13 H (RR)	\$43.45	\$38.45
Sonic	54 "	51% Acrylic/49% Polyester/Crypton	16.75 V / 14.5 H (RR)	\$32.45	\$27.45
* Sophora (On Serenade PFP)	58 "	100% Polyester FR Hybrid / Crypton	13.5 V / 27 H	\$24.95	\$20.95
Sparkle	54 "	57% Polyester-22% Rayon-14% Acrylic-7% Cotton / Crypton	3.375 V / 13.125 H (RR)	\$36.95	\$31.95
* Springwood (On Serenade PFP)	58 "	100% Polyester FR Hybrid / Crypton	18.5 V / 15.75 H (RR)	\$24.95	\$20.95
Stefania	54 "	40% Polyester/ 37% Cotton/ 23% Rayon/Crypton	4.5 V / 11.5 H (RR)	\$38.95	\$33.95
* Steward (On Serenade PFP)	58 "	100% Polyester FR Hybrid / Crypton	0.88 V / 0.88 H	\$24.95	\$20.95
Susana	54 "	59% Cotton/ 41% Polyester/Crypton	1.66 V / 1.13 H (RR)	\$36.45	\$31.45
Vacation-C	54 "	100% Polyurethane Face/100% Polyester Backing	None	\$49.95	\$44.95
Vaggio	54 "	100% PVC Face / 100% Brushed Polyester Knit Backing / Resilience Finish	None	\$21.70	\$17.70
Valencia	54 "	100% PVC Face / 100% Polyester Knit Backing	None	\$26.95	\$22.95
Valentine	54 "	100% PVC Face / Polyester Cotton Blend Backing	None	\$34.95	\$29.95

Barrier Upholstery

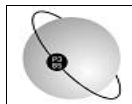

*Our Crypton prints are available on all of our drapery weight print ground cloths for a minimum of one piece. Please call your local representative or the New York Office for assistance.

Pattern Name	Width	Product Data	Repeat (Inches)	Cut Price	Bolt Price
Valet	54 "	100% Polyurethane / 100% Polyester Knit Backing / Cleangene Finish	None	\$40.95	\$35.95
Valiant	54 "	100% Polyurethane Face / 100% Polyester Knit Backing	None	\$43.95	\$38.95
Valid	54 "	100% PVC Face / Polyester Cotton Blend Backing	None	\$34.95	\$29.45
Valise-C	54 "	100% PVC Face/100% Polyester Backing	None	\$24.95	\$20.95
Valley	54 "	100% Virgin Vinyl Face / Polyester Rayon Blend Backing	None	\$18.95	\$14.95
Valone	54 "	100% PVC Face / 100% Brushed Polyester Knit Backing / Resilience Finish	None	\$21.70	\$17.70
Valor	54 "	100% PVC Face / Polyester Cotton Blend Backing	None	\$34.95	\$29.45
Value	54 "	100% PVC Face / Polyester Cotton Blend Backing	None	\$34.95	\$29.45
Vancouver	54 "	100% PVC Face / 100% Polyester Backing	9.75 V / 9.75 H	\$44.95	\$39.95
Vane	54 "	100% Polyurethane Face / 100% Polyester Knit Backing / Cleangene Finish	None	\$40.95	\$35.95
Vanguard	54 "	100% Polyurethane Face / 100% Polyester Knit Back/ink resistant finish	None	\$34.95	\$29.95
Vanicia	54 "	100% PVC Face / 100% Brushed Polyester Knit Backing / Resilience Finish	None	\$22.20	\$18.20
Vanish	54 "	100% PVC Face / 100% Polyester Backing	9 V / 9 H	\$26.95	\$21.95
Vanity	54 "	100% PVC Face / Polyester Cotton Blend Backing	None	\$34.45	\$29.45
Vantage-C	54 "	100% PVC Face/100% Polyester Back	None	\$24.95	\$20.95
Varsity	54 "	100% PVC Face/100% Polyester Back	None	\$29.95	\$24.95
Vassal	54 "	Vinyl with Polyurethane Top Coat	17.25 V / 17.875 H	\$34.95	\$31.95
Vector	54 "	100% PVC Face / 100% Polyester Backing	9 V / 9 H	\$26.95	\$21.95
Velocity	54 "	100% PVC Face / 100% Polyester Knit Backing	None	\$26.95	\$22.95
Venture	54 "	100% PVC Face / Polyester Cotton Blend Backing	None	\$34.95	\$29.45
Venue	54 "	100% PVC Face / Polyester Cotton Blend Backing	None	\$34.95	\$29.45
Verbana	54 "	100% Polyurethane	None	\$37.95	\$32.95
Verdi	54 "	100% Polyurethane	None	\$45.95	\$40.95
Verdict	20 "	100% Polyurethane Face / 100% Polyester Knit Back/ink resistant finish	None	\$34.95	\$29.95
Verity	54 "	100% Polyurethane Face / 100% Polyester Backing	None	\$27.95	\$22.95
Verse	54 "	100% Polyurethane / 100% Polyester Knit Backing / Cleangene Finish	None	\$40.95	\$35.95
Vevel	54 "	100% PVC Face / 100% Polyester Backing	None	\$28.95	\$23.95

Barrier Upholstery



*Our Crypton prints are available on all of our drapery weight print ground cloths for a minimum of one piece. Please call your local representative or the New York Office for assistance.

Pattern Name	Width	Product Data	Repeat (Inches)	Cut Price	Bolt Price
Vex	54 "	100% Polyurethane Face / 100% Polyester Knit Back/ink resistant finish	8 V / 8 H	\$34.95	\$29.95
Vexing	54 "	100% PVC Face / 100% Polyester Backing	None	\$27.95	\$22.95
Vibe	54 "	100% PVC Face/100% Polyester Back	None	\$24.95	\$20.95
Vibrant	54 "	100% PVC Face / 100% Brushed Polyester Knit Backing / Resilience Finish	None	\$24.95	\$20.95
Viceroy-C	54 "	100% PVC Face / 100% Polyester Back	None	\$29.95	\$24.95
Victory	54 "	100% PVC Face / 100% Brushed Polyester Knit Backing / Resilience Finish	None	\$24.95	\$20.95
Video	54 "	100% PVC Face / 100% Polyester Backing	None	\$24.95	\$20.95
Vienna	54 "	100% PVC Face / Polyester/Cotton Knit Backing	None	\$33.95	\$28.95
View	54 "	100% Polyurethane / 100% Polyester Knit Backing / Cleangene Finish	None	\$40.95	\$35.95
Vigil	54 "	100% Polyurethane / 100% Polyester Knit Backing / Cleangene Finish	None	\$40.95	\$35.95
Viletta	54 "	100% PVC Face / 100% Brushed Polyester Knit Backing / Resilience Finish	None	\$24.70	\$20.70
Villa	54 "	100% Polyurethane / 100% Polyester Knit Backing / Cleangene Finish	None	\$39.95	\$34.95
Village	54 "	100% PVC Face / 100% Polyester Backing	None	\$29.95	\$24.95
Vineyard-C	54 "	100% PVC Face / 100% Polyester Backing	None	\$22.95	\$18.95
Vintage	54 "	100% PVC Face/100% Polyester Back	None	\$24.95	\$20.95
Virtual	54 "	100% PVC Face / 100% Brushed Polyester Knit Backing / Resilience Finish	None	\$24.45	\$20.45
Visit	54 "	100% PVC Face	None	\$34.95	\$29.45
Vista	54 "	100% PVC Face / 100% Polyester Backing	15.5 V / 17.5 H	\$45.95	\$40.95
Visual	54 "	100% PVC Face / 100% Polyester back	None	\$20.70	\$16.70
Vital	54 "	100% PVC Face / 100% Polyester Backing	None	\$26.95	\$21.95
Vivid	54 "	100% Polyurethane Face / 100% Polyester Knit Back/ink resistant finish	None	\$34.95	\$29.95
Vlade	54 "	100% PVC Face / Polyester Rayon Blend Backing	None	\$27.95	\$22.95
Vocal	54 "	100% PVC Face / 100% Polyester Back	None	\$26.95	\$21.95
Vogue	54 "	100% Polyurethane / 100% Polyester Knit Backing / Cleangene Finish	None	\$40.95	\$35.95
Volley	54 "	100% PVC Face / 100% Polyester Knit Backing	None	\$26.95	\$22.95
Volpe	54 "	100% PVC Face / Polyester Rayon Blend Backing	None	\$29.95	\$24.95
Vortex	54 "	100% Polyurethane Face / 100% Polyester Knit Back/ink resistant finish	None	\$34.95	\$29.95

Barrier Upholstery

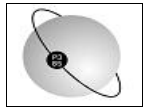

*Our Crypton prints are available on all of our drapery weight print ground cloths for a minimum of one piece. Please call your local representative or the New York Office for assistance.

Pattern Name	Width	Product Data	Repeat (Inches)	Cut Price	Bolt Price
Vow	54 "	100% Polyurethane Face / 100% Polyester Knit Back/ink resistant finish	8 V / 8 H	\$29.95	\$24.95
Voyage	54 "	100% PVC Face/100% Polyester Back	None	\$33.95	\$28.95
Vrignon	54 "	100% PVC Face / 100% Polyester Backing	None	\$27.95	\$22.95
Waltz	54 "	100% Polyester / Crypton	1.5 H (RR)	\$34.95	\$29.95
Wanderer	54 "	100% Polyester/Crypton Barrier	None	\$34.95	\$29.95
Wannabee	54 "	54% Acrylic - 47% Polyester / Crypton	7.25 V / 8.5 H (RR)	\$34.95	\$29.95
Waveband	54 "	54% Recycled Polyester - 46% Polyester / Crypton	5 V / 6 H (RR)	\$35.95	\$30.95
Website	54 "	100% Polyester / Crypton	2.5 V / 3.5 H (RR)	\$33.95	\$28.95
Welcome	54 "	95% Poly/3% Post ind Recy/2% Post Con Rec Poly/Crypton Barrier	None	\$35.95	\$30.95
Whisper	54 "	100% Polyester / Crypton	23.5 V / 14.25 H	\$42.95	\$37.95
Wish	54 "	62% Poly/38% Recycled Poly/Crypton Barrier	None	\$41.95	\$36.95
Wonder	54 "	53%Poly/16% Post Con Rec/31% Post Ind. Rec/Crypton Barrier	None	\$41.45	\$36.45

Outdoor Upholstery



All fabrics in this collection are weather-ready, tough enough for outdoors, comfortable enough for indoors and stylish enough for anything.

Fiber Content - 100 % Solution-Dyed Acrylic or Bella Dura Olefin

- High Performance
- Excellent UV Color Retention
- Great Hand
- Durable Water Repellent

Pattern Name	Width	Product Data	Repeat (Inches)	Cut Price	Bolt Price
Anchor-C	54 "	100% Solution Dyed Acrylic	9 H	\$26.95	\$21.95
Barrier Reef-C	54 "	100% Bella Dura Olefin	13.5 V / 13.5 H	\$35.45	\$30.45
Beach Club-C	54 "	100% Bella Dura Olefin	1.75 V / 1.75 H	\$35.45	\$30.45
Cozumel-C	54 "	100% Bella Dura Olefin/Soil & Stain	20 V / 18.5 H	\$37.95	\$32.95
Crest-C	54 "	100% Bella Dura Olefin/Soil & Stain	8.5 V / 3.5 H	\$36.95	\$31.95
Dock-C	54 "	100% Bella Dura Olefin/Soil & Stain	1.5 V / 1 H (RR)	\$33.95	\$28.95
Escape-C	54 "	100% Bella Dura Olefin/Soil and Stain	1.6 V / 9 H	\$33.95	\$28.95
Horizons-C	54 "	100% Bella Dura Olefin/Soil & Stain	14 V / 11.5 H (RR)	\$43.95	\$38.95
Island Breeze-C	54 "	100% Bella Dura Olefin/Soil & Stain Finish	21.12 V / 12.75 H	\$35.95	\$30.95
Poolside-C	54 "	100% Bella Dura Olefin	0.25 V / 8.75 H (RR)	\$34.45	\$29.45
Puka Shells-C	54 "	63% Solution Dyed Acrylic/37% Solution Dyed Polyester/Soil & Stain finish	14.2 V / 14.46 H	\$42.95	\$37.95
Ray-C	54 "	100% Solution Dyed Acrylic	3.38 V	\$32.95	\$27.95
Relax-C	54 "	100% Bella Dura Olefin/Soil & Stain Finish	27.85 V / 13.5 H	\$36.95	\$31.95
Sandbar-C	54 "	100% Bella Dura Olefin	None	\$38.95	\$33.95
Schooner-C	54 "	100% Solution Dyed Acrylic	4.5 H	\$30.95	\$25.95
Shoreline-C	54 "	100% Solution Dyed Acrylic	None	\$24.45	\$20.45
Skipper-C	54 "	100% Solution Dyed Acrylic	None	\$39.95	\$34.95
Starry Nite-C	54 "	100% Solution Dyed Acrylic	1.15 V / 1.65 H	\$33.95	\$28.95
Sunny Days-C	54 "	100% Solution Dyed Acrylic	4.5 H	\$26.95	\$21.95
Vacation-C	54 "	100% Polyurethane Face/100% Polyester Backing	None	\$49.95	\$44.95
Valise-C	54 "	100% PVC Face/100% Polyester Backing	None	\$24.95	\$20.95
Vantage-C	54 "	100% PVC Face/100% Polyester Back	None	\$24.95	\$20.95
Vineyard-C	54 "	100% PVC Face / 100% Polyester Backing	None	\$22.95	\$18.95

For **maintenance and light cleaning**, brush off dirt. Add a quarter cup of mild soap to a gallon of lukewarm water. Use a sponge or soft brush to apply the solution, allowing it to soak into fabric. Rinse thoroughly with clean water, then air dry. **Removable umbrella and cushion covers** may be machine washed in cold water using normal amounts of mild soap. Air dry. To **spot clean**, spray with a mist of water and mild soap, then clean vigorously with a sponge, brush or clean towel. Rinse thoroughly in clean water, then air dry, blot or remove, use a **wet vacuum**. Repeat final steps until all soap residue is gone. To **clean stubborn stains and/or mildew**, use 1 cup bleach and 1/4 cup of mild soap per gallon of clean water (increase for severe stains). Soak affected area for 20 minutes before using sponge or clean towel to remove stain. Rinse well and air dry. **Removable umbrella and cushion covers** may be machine washed in cold water using normal amounts of mild soap and 1 cup of bleach. Air dry. **DO NOT DRY CLEAN. IF NECESSARY, CAREFULLY IRON ON SYNTHETIC SETTING; DO NOT USE STEAM.**



Green Print Cloth Collection Alternate Ground Cloths...

- Greenbay** 4.4 ounces per linear yard, 54" wide. 100% **Recycled** Polyester with permanent flame resistance. Sheeting weave made from recycled textured filament yarns warp and filling. Washable and dry cleanable, dimensionally stable with less than 2% residual shrinkage. Complies with the following FR specifications: NFPA 701 Small Scale, 1989 and 2004 Editions, City of Boston, New York and the State of California Title 19. Recommended for drapery and bedding applications.
- Greenwood** 9 ounces per linear yard, 54" wide. 100% **Recycled** Polyester with permanent flame resistance. Hookweave texture made from recycled textured filament yarns warp and filling. Washable and dry cleanable, dimensionally stable with less than 2% residual shrinkage. Complies with the following FR specifications: NFPA 701, 2004 Edition, City of Boston and New York fire codes. Recommended for drapery and bedding applications.
- Greenland** 9 ounces per linear yard, 54" wide. 100% **Recycled** Polyester with permanent flame resistance. Oxford weave made from recycled textured filament yarns warp and filling. Washable and dry cleanable, dimensionally stable with less than 2% residual shrinkage. Complies with the following FR specifications: NFPA 701, 2004 Edition, City of Boston and New York fire codes. Recommended for drapery and bedding applications.
- Greenfield** 9.5 ounces per linear yard, 54" wide. 100% **Recycled** Polyester with permanent flame resistance. Sateen weave made from recycled textured filament yarns warp and filling. Washable and dry cleanable, dimensionally stable with less than 2% residual shrinkage. Complies with the following FR specifications: NFPA 701 Small Scale, 1989 and 2004 Editions, City of Boston, New York and the State of California Title 19. Recommended for drapery and bedding applications.
- Greenway** 12 Ounces per linear yard, 54" wide. 55% Recycled Polyester - 45% FR Polyester, flame resistant. Double Sided Satin with Light Dimming qualities. Excellent insulating and sound-baffling characteristics. Greenway is treated with an Antibacterial and Antimicrobial finish. Washable and dry cleanable. Complies with the following FR specifications: NFPA 701, 1989 and 2004 Editions, City of Boston, New York, and the State of California Title 19. Recommended for drapery and Cubicle Curtain applications.

*Please note: all of our drapery prints are available on various alternate base cloths. For Crypton base cloths the minimum order required is 5 yards. For drapery weight alternate base cloths the minimum order required is 75 yards.

Pattern Name	Width	Product Data	Repeat (Inches)	Cut Price	Bolt Price
* Earthy-C (On Greenland PFP)	54 "	100% Recycled Polyester FR	None	\$21.45	\$17.45
* Eccentric-C (On Greenland PFP)	54 "	100% Recycled Polyester FR	17.75 V / 13.5 H	\$21.45	\$17.45
* Ecliptic-C (On Greenwood PFP)	54 "	100% Recycled Polyester FR	13.5 V / 27 H	\$20.95	\$16.95
* Ecology-C (On Greenland PFP)	54 "	100% Recycled Polyester FR	27 V / 27 H	\$21.45	\$17.45
* Effervesce-C (On Greenwood PFP)	54 "	100% Recycled Polyester FR	24 V / 27 H	\$20.95	\$16.95
* Electron-C (On Greenwood PFP)	54 "	100% Recycled Polyester FR	18.5 V / 27 H	\$20.95	\$16.95
* Element-C (On Greenland PFP)	54 "	100% Recycled Polyester FR	9 H	\$21.45	\$17.45
* Elixir-C (On Greenwood PFP)	54 "	100% Recycled Polyester FR	6.25 V / 11.5 H	\$20.95	\$16.95
* Eloquent-C (On Greenfield PFP)	54 "	100% Recycled Polyester FR	9 H	\$20.95	\$16.95
* Embellish-C (On Greenwood PFP)	54 "	100% Recycled Polyester FR	27 V / 13 H	\$20.95	\$16.95
* Eminence-C (On Greenwood PFP)	54 "	100% Recycled Polyester FR	3 V / 27 H	\$20.95	\$16.95
* Emperor-C (On Greenwood PFP)	54 "	100% Recycled Polyester FR	27 V / 27 H	\$20.95	\$16.95
* Enchanted-C (On Greenfield PFP)	54 "	100% Recycled Polyester FR	27 V / 13.5 H	\$20.95	\$16.95
* Gaiety-C (On Greenwood PFP)	54 "	100% Recycled Polyester FR	9 V / 9 H	\$20.95	\$16.95



*Please note: all of our drapery prints are available on various alternate base cloths. For Crypton base cloths the minimum order required is 5 yards. For drapery weight alternate base cloths the minimum order required is 75 yards.

Pattern Name	Width	Product Data	Repeat (Inches)	Cut Price	Bolt Price
* Galahad-C (On Greenfield PFP)	54 "	100% Recycled Polyester FR	7 V	\$20.95	\$16.95
* Gearbox-C (On Greenwood PFP)	54 "	100% Recycled Polyester FR	10.5 V / 9 H	\$20.95	\$16.95
* Genesis-C (On Greenwood PFP)	54 "	100% Recycled Polyester FR	18 V / 18 H	\$20.95	\$16.95
* Gentry-C (On Greenfield PFP)	54 "	100% Recycled Polyester FR	6.75 V / 6.75 H	\$20.95	\$16.95
* Giggle-C (On Greenwood PFP)	54 "	100% Recycled Polyester FR	18 H	\$20.95	\$16.95
* Glance-C (On Greenwood PFP)	54 "	100% Recycled Polyester FR	None	\$20.95	\$16.95
* Glimmer-C (On Greenwood PFP)	54 "	100% Recycled Polyester FR	18 V / 9 H	\$20.95	\$16.95
* Glorious-C (On Greenwood PFP)	54 "	100% Recycled Polyester FR	27 V / 27 H	\$20.95	\$16.95
* Grandeur-C (On Greenfield PFP)	54 "	100% Recycled Polyester FR	27 V / 27 H	\$20.95	\$16.95
* Guru-C (On Greenwood PFP)	54 "	100% Recycled Polyester FR	0.75 V / 13.5 H	\$20.95	\$16.95
* Hamilton-C (On Greenwood PFP)	54 "	100% Recycled Polyester FR	27 V / 27 H	\$20.95	\$16.95
* Havana-C (On Greenwood PFP)	54 "	100% Recycled Polyester FR	25 V / 12 H	\$20.95	\$16.95

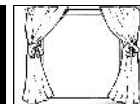

StainSmart™
ANOTHER SMART FABRIC BY MILLIKEN
PATENT PENDING

www.StainSmart.com

StainSmart is a registered trademark of Milliken & Company



Alternate Ground Cloths...

Please note that all of our prints are stocked on a "Host" base cloth as shown in our sample books. However, most are available on alternate base cloths for a minimum of one piece. Specifications for the alternate print grounds follow; please contact your local representative or our New York office for pricing and particulars.

- Ballet** 12 Ounces per linear yard, 54" wide, "All spun basket weave with the softness and resilience of a cotton duck fabric" 100% spun polyester with an "Intrinsic™" permanent flame resistance. Passes over 50,000 double rubs (ASTM D-3597 M). Complies with the following FR specifications: NFPA 701 Small Scale, 1989 and 2004 Editions, City of Boston, New York and the State of California Title 19. Recommended for draperies, bedspreads and upholstery applications
- Crescendo** 8 Ounces per linear yard, 54" wide, "Dobby Texture", 100% FR Polyester - inherently flame resistant. Washable and dry cleanable. Complies with the following FR specifications: NFPA 701 Small Scale, 1989 and 2004 Editions, City of Boston, New York, and the State of California Title 19. Recommended for drapery and bedspread applications.
- Applause** 5.25 Ounces per linear yard, 54" wide, textured filament warp and filling Sheeting weave, 100% Polyester, "Intrinsic™" permanent flame resistance, Visa® soil and stain release finish. Washable and dry cleanable. Permanently FR and complies with the following FR specifications: NFPA 701 Small Scale, 1989 and 2004 Editions, City of Boston, New York and the State of California Title 19. Recommended for drapery and bedspread applications.
- Concerto** 10 Ounces per linear yard, 54" wide, poplin cotton like weave and textured. 100% Polyester, "Intrinsic™" Permanently flame resistant. Passes NFPA 701, 1989 and 2004 Editions of flame resistance test methods and complies with other major FR specifications, Visa® soil and stain release finish. Washable and dry cleanable. Dimensionally stable. Passes over 50,000 double rubs on the Wyzenbeek #10 cotton duck abrasion test - ASTM-D-3597-M Recommended for drapery, bedspread and upholstery applications
- Maestro** 7.5 Ounces per linear yard, 54" wide, 100% Textured Polyester, "Intrinsic™" Permanently Flame Resistant. Complies with the following FR specifications: NFPA 701 Small Scale, 1989 and 2004 Editions, City of Boston, New York and the State of California Title 19. Visa® soil and stain release finish. Washable and dry cleanable. Easy care. Dimensionally stable. Recommended for drapery and bedspread applications.
- Cantata** 12 Ounces per linear yard, 54" wide, 100% Polyester. Sanded face, "Stain Smart™", a new permanent treatment provides Excellent repellency. Liquid spills bead up and wipe right off. Soil and stains wipe away. Ground-in stains wash out easily. Visa® soil and stain release finish. Machine washable. Easy care. Dimensionally stable. Cleaning Code: WS, "Intrinsic™". Permanently flame resistant. Complies with the following FR specifications: NFPA 701, 1989 and 2004 Editions, City of Boston, New York and the State of California Title 19. Passes over 50,000 double rubs on the Wyzenbeek #10 cotton duck abrasion test - ASTM-D-3597-M. Recommended for draperies, cubicle privacy curtains, bedspreads and upholstery applications.
- Soprano** 7.5 Ounces per linear yard, 54" wide Textured filament warp, textured filament filling, Ottoman weave. 100% Polyester FR blend. Inherently flame resistant. Complies with the following FR specifications: NFPA 701 Small Scale, 1989 and 2004, City of Boston, New York and the State of California Title 19. Washable and dry cleanable. Recommended for drapery and bedspread applications.
- Vespers** 12 Ounces per linear yard, 54" wide. Double Sided Satin with Light Dimout qualities. Excellent insulating and sound-baffling characteristics. 100% Polyester. Flame resistant. Washable and dry cleanable. Complies with the following FR specifications: NFPA 701, 1989 and 2004 Editions, City of Boston, New York, and the State of California Title 19. Recommended for drapery applications.
- Medley** 12 Ounces per linear yard, 54" wide. Textured filament warp and filling yarns with a natural "Linen" texture weave. 100% Polyester FR Blend Inherently Flame Resistant. Complies with NFPA 701-2010. Washable and dry cleanable. Recommended for drapery and bedspread applications.
- Eclipse** 14 ounces per linear yard, 54" wide. 100% Polyester Sateen like face with Three Pass Blackout FR Acrylic Backing. This fabric provides 100% Light Blackout while also providing noise reduction properties as well as thermal insulation.

Drapery Fabrics

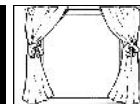

*Please note: all of our drapery prints are available on various alternate base cloths. For Crypton base cloths the minimum order required is 5 yards. For drapery weight alternate base cloths the minimum order required is 75 yards.

Pattern Name	Width	Product Data	Repeat (Inches)	Cut Price	Bolt Price
* Absolute-C (On Ballet PFP)	54 "	100% Polyester FR	9 V / 6.75 H	\$20.95	\$16.95
* Accolade-C (On Medley PFP)	58 "	100% Polyester FR Hybrid	25 V / 27 H	\$19.45	\$15.45
* Acoustic-C (On Medley PFP)	58 "	100% Polyester FR Hybrid	18 V / 18 H	\$19.45	\$15.45
Alden	55 "	100% Polyester FR	0.5 H	\$20.45	\$16.45
* Allegory-C (On Ballet PFP)	54 "	100% Polyester FR	6.75 H	\$20.95	\$16.95
* Arista-C (On Soprano PFP)	54 "	100% Polyester FR	25 V / 13.5 H	\$18.45	\$14.45
* Aristocrat-C (On Soprano PFP)	54 "	100% Polyester FR	9 V / 10.75 H	\$18.45	\$14.45
* Aristotle-C (On Soprano PFP)	54 "	100% Polyester FR	25 V / 13.5 H	\$18.45	\$14.45
Artisanal-C	54 "	100% Polyester FR Blend	None	\$23.95	\$19.95
* Aurora-C (On Medley PFP)	58 "	100% Polyester FR Hybrid	27 V / 15.75 H	\$19.45	\$15.45
* Avalon-C (On Medley PFP)	58 "	100% Polyester FR Hybrid	25 V / 27 H	\$19.45	\$15.45
* Avery-C (On Medley PFP)	58 "	100% Polyester FR Hybrid	25 V / 27 H	\$19.45	\$15.45
Bach-C	58 "	100% Polyester FR Hybrid	None	\$18.95	\$14.95
Bahia	54 "	100% Polyester FR	None	\$17.45	\$13.45
Bali	54 "	100% Polyester FR Blend	None	\$22.95	\$18.95
Bangkok-C	57 "	100% Inherent Polyester FR	None	\$25.95	\$20.95
Bauble-C	54 "	100% Polyester FR Blend	1.5 V / 1.5 H	\$23.95	\$19.95
Beethoven-C	58 "	100% Polyester FR Hybrid	6 H	\$18.95	\$14.95
Belmar-C	55 "	100% Polyester FR	None	\$26.45	\$21.45
Biltmore-C	54 "	100% Polyester FR Blend	3.5 V / 1 H	\$23.95	\$19.95
Birmingham	54 "	100% Polyester FR Blend	None	\$20.95	\$16.95
Bliss	72 "	100% Polyester Hybrid FR	36.5 V / 19 H (RR)	\$34.95	\$29.95
Blossom-C	54 "	100% polyester FR Blend	13.5 V / 13.5 H	\$23.95	\$19.95
Brahms-C	54 "	100% Polyester FR Hybrid	None	\$18.95	\$14.95
Canopy	72 "	100% Polyester Hybrid FR	24 V / 20 H (RR)	\$38.95	\$33.95
Chancery-C	54 "	100% Polyester FR Blend	18 V / 13.5 H	\$23.95	\$19.95
* Cheryl (On Medley PFP)	58 "	100% Polyester FR Hybrid	None	\$19.45	\$15.45
Compass-C	54 "	100% Polyester FR Blend	None	\$24.95	\$19.95
Connoisseur-C	54 "	100% Polyester FR Blend	1 V / 2.5 H	\$23.95	\$19.95
* Darius-C (On Vespers PFP)	60 "	100% Polyester FR	None	\$20.45	\$16.45
* Darkness-C (On Eclipse PFP)	57 "	100% Polyester / Triple Pass FR Blackout	None	\$26.95	\$22.95

Drapery Fabrics

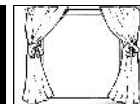

*Please note: all of our drapery prints are available on various alternate base cloths. For Crypton base cloths the minimum order required is 5 yards. For drapery weight alternate base cloths the minimum order required is 75 yards.

Pattern Name	Width	Product Data	Repeat (Inches)	Cut Price	Bolt Price
* Dazzle-C	54 "	80% Polyester - 20% Cotton/ Triple Pass FR Blackout	None	\$28.95	\$23.95
* Deep-C (On Eclipse PFP)	57 "	100% Polyester / Triple Pass FR Blackout	None	\$26.95	\$22.95
* Delphi-C (On Eclipse PFP)	57 "	100% Polyester / Triple Pass FR Blackout	None	\$26.95	\$22.95
* Dense-C (On Eclipse PFP)	57 "	100% Polyester / Triple Pass FR Blackout	None	\$26.95	\$22.95
* Dervish-C (On Vespers PFP)	60 "	100% Polyester FR	None	\$20.45	\$16.45
* Devon-C (On Vespers PFP)	60 "	100% Polyester FR	None	\$20.45	\$16.45
Diana	54 "	100% Polyester FR	None	\$20.45	\$16.45
Dimmer	60 "	100% Polyester FR	None	\$14.95	\$11.95
* Divine-C	54 "	49% Cotton - 51% Polyester/ Triple Pass FR Blackout	None	\$28.95	\$23.95
* Domino-C (On Vespers PFP)	60 "	100% Polyester FR	None	\$20.45	\$16.45
* Dream-C	54 "	44% Cotton - 56% Polyester/ Triple Pass FR Blackout	None	\$28.95	\$23.95
Duchess-C	54 "	100% Polyester FR Blend	None	\$23.95	\$19.95
* Dusk-C	54 "	41% Cotton - 59% Polyester/ Triple Pass FR Blackout	None	\$28.95	\$23.95
* Earthy-C (On Greenland PFP)	54 "	100% Recycled Polyester FR	None	\$21.45	\$17.45
* Eccentric-C (On Greenland PFP)	54 "	100% Recycled Polyester FR	17.75 V / 13.5 H	\$21.45	\$17.45
* Ecliptic-C (On Greenwood PFP)	54 "	100% Recycled Polyester FR	13.5 V / 27 H	\$20.95	\$16.95
* Ecology-C (On Greenland PFP)	54 "	100% Recycled Polyester FR	27 V / 27 H	\$21.45	\$17.45
* Effervesce-C (On Greenwood PFP)	54 "	100% Recycled Polyester FR	24 V / 27 H	\$20.95	\$16.95
El Yunque-C	54 "	100% Polyester FR Blend	None	\$24.95	\$19.95
* Electron-C (On Greenwood PFP)	54 "	100% Recycled Polyester FR	18.5 V / 27 H	\$20.95	\$16.95
* Element-C (On Greenland PFP)	54 "	100% Recycled Polyester FR	9 H	\$21.45	\$17.45
* Elixir-C (On Greenwood PFP)	54 "	100% Recycled Polyester FR	6.25 V / 11.5 H	\$20.95	\$16.95
* Elizabeth (On Medley PFP)	58 "	100% Polyester FR Hybrid	None	\$19.45	\$15.45
* Eloquent-C (On Greenfield PFP)	54 "	100% Recycled Polyester FR	9 H	\$20.95	\$16.95
* Embellish-C (On Greenwood PFP)	54 "	100% Recycled Polyester FR	27 V / 13 H	\$20.95	\$16.95
* Eminence-C (On Greenwood PFP)	54 "	100% Recycled Polyester FR	3 V / 27 H	\$20.95	\$16.95
* Emperor-C (On Greenwood PFP)	54 "	100% Recycled Polyester FR	27 V / 27 H	\$20.95	\$16.95
* Enchanted-C (On Greenfield PFP)	54 "	100% Recycled Polyester FR	27 V / 13.5 H	\$20.95	\$16.95
Eureka-C	54 "	100% Polyester FR Blend	None	\$23.95	\$19.95
Extinct-C	54 "	100% Polyester FR Blend	None	\$24.95	\$19.95
Fabray-C	118 "	100% Polyester FR	1.25 H (RR)	\$28.95	\$23.95
Façade-C	118 "	100% Polyester	6.75 H (RR)	\$28.95	\$24.95
Factor-C	118 "	100% Polyester	12 V / 5 H (RR)	\$13.95	\$11.95
Fad-C	118 "	100% Polyester	None	\$22.95	\$18.95

Drapery Fabrics

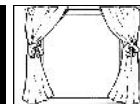

*Please note: all of our drapery prints are available on various alternate base cloths. For Crypton base cloths the minimum order required is 5 yards. For drapery weight alternate base cloths the minimum order required is 75 yards.

Pattern Name	Width	Product Data	Repeat (Inches)	Cut Price	Bolt Price
Fair-C	118 "	100% Polyester FR	None	\$20.45	\$16.45
Fairlee-C	118 "	100% Polyester FR	7 H (RR)	\$25.95	\$21.95
Faison-C	118 "	100% Polyester FR	9.75 H (RR)	\$29.95	\$24.95
Faizah-C	118 "	100% Polyester FR	23 V / 11 H (RR)	\$39.95	\$34.95
Falana-C	118 "	100% Polyester FR	7 H (RR)	\$24.95	\$20.95
Falk-C	118 "	100% Polyester FR	4 H (RR)	\$21.95	\$17.95
Fallen-C	118 "	65% Polyester - 35% Rayon	17 V / 34.5 H (RR)	\$32.95	\$27.95
Falls-C	118 "	100% Polyester FR	2.1 V / 7.1 H (RR)	\$21.45	\$17.45
Family-C	118 "	100% Polyester	20 V / 20.5 H (RR)	\$13.95	\$11.95
Fanciful-C	118 "	100% Polyester	21.5 V / 12.5 H (RR)	\$13.95	\$11.95
Fanfare-C	118 "	100% Polyester FR	0.38 H (RR)	\$39.95	\$34.95
Fanning-C	118 "	100% Polyester FR	10 H (RR)	\$28.95	\$23.95
Fantasia-C	118 "	100% Polyester FR	21.5 H (RR)	\$23.95	\$19.95
Fantasy-C	118 "	100% Polyester FR	2.1 V / 2.6 H (RR)	\$24.95	\$20.95
Fantine-C	118 "	100% Polyester FR	8 H (RR)	\$27.95	\$23.95
Fargas-C	118 "	100% Polyester FR	14.75 V (RR)	\$31.95	\$26.95
Faris-C	118 "	100% Polyester FR	6 V / 5.75 H (RR)	\$36.95	\$31.95
Farmer-C	118 "	100% Polyester FR	None	\$23.95	\$19.95
Farrah-C	118 "	100% Polyester FR	None	\$19.95	\$16.95
Farr-C	118 "	100% Polyester FR	None	\$25.95	\$21.95
Farrow-C	118 "	100% Polyester FR	14.5 V / 12.5 H (RR)	\$37.95	\$32.95
Farthing-C	118 "	100% Polyester FR	9.5 V / 8 H (RR)	\$31.95	\$26.95
Fathom-C	118 "	100% Polyester	2.25 H (RR)	\$29.95	\$24.95
Favre-C	118 "	100% Polyester FR	11.5 V / 11 H (RR)	\$40.45	\$35.45
Fawn-C	118 "	100% Polyester	None	\$27.50	\$23.50
Faye-C	118 "	100% Polyester FR	None	\$20.70	\$16.70
Fazio-C	118 "	100% Polyester FR	16 V / 28 H (RR)	\$29.95	\$24.95
Feast-C	118 "	100% Polyester	None	\$27.50	\$23.50
Feather-C	118 "	100% Polyester	7.38 V / 6.25 H (RR)	\$13.95	\$11.95
Feldon-C	118 "	100% Polyester FR	None	\$31.95	\$26.95
Felice-C	118 "	100% Polyester FR	11 V / 8 H (RR)	\$31.95	\$26.95
Feline-C	118 "	100% Polyester FR	16 V / 22 H (RR)	\$39.95	\$34.95
Feliz-C	118 "	100% Polyester FR	12 V / 2 H (RR)	\$28.95	\$23.95
Feller-C	118 "	100% Polyester FR	6 H (RR)	\$23.45	\$19.45
Fellow-C	118 "	100% Polyester FR	8.5 H (RR)	\$29.95	\$25.95
Fergie-C	118 "	65% Polyester - 35% Rayon	2 V / 2 H (RR)	\$38.95	\$33.95

Drapery Fabrics

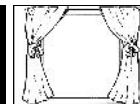

*Please note: all of our drapery prints are available on various alternate base cloths. For Crypton base cloths the minimum order required is 5 yards. For drapery weight alternate base cloths the minimum order required is 75 yards.

Pattern Name	Width	Product Data	Repeat (Inches)	Cut Price	Bolt Price
Feronia-C	118 "	100% Polyester FR	13 H (RR)	\$35.95	\$30.95
Ferraro-C	118 "	100% Polyester FR	0.19 V / 1.75 H (RR)	\$21.45	\$17.45
Ferrer-C	118 "	100% Polyester FR	0.375 V / 0.5 H (RR)	\$29.95	\$24.95
Ferris-C	118 "	100% Polyester FR	8 V / 10 H (RR)	\$27.45	\$22.45
Ferry-C	118 "	100% Polyester	8 H (RR)	\$29.95	\$24.95
Festoon-C	108 "	100% Polyester FR	8.25 V / 3 H (RR)	\$37.45	\$32.45
Fez-C	118 "	100% Polyester FR	None	\$19.95	\$16.95
Fiction-C	118 "	100% Polyester	1.75 V / 1.38 H (RR)	\$13.95	\$11.95
Fiddle-C	118 "	100% Polyester	2 H (RR)	\$24.95	\$20.95
Fidela-C	118 "	100% Polyester FR	31 V / 25 H (RR)	\$25.95	\$21.95
Fidelity-C	118 "	100% Polyester FR	0.15 H (RR)	\$20.45	\$16.45
Fiery-C	118 "	100% Polyester	None	\$27.50	\$23.50
Fiesta-C	118 "	100% Polyester FR	None	\$23.95	\$19.95
Fig-C	118 "	100% Polyester FR	None	\$8.95	\$5.95
Figgins-C	118 "	100% Polyester FR	3.25 V / 3.5 H (RR)	\$22.95	\$18.95
Fiji-C	118 "	100% Polyester FR	None	\$21.95	\$17.95
Fine-C	118 "	100% Polyester	None	\$38.95	\$33.95
Finery-C	118 "	100% Polyester FR	10.25 H (RR)	\$26.95	\$21.95
Finicky-C	118 "	100% Polyester	None	\$31.95	\$26.95
Finite-C	118 "	100% Polyester	None	\$24.95	\$20.95
Finn-C	118 "	100% Polyester	None	\$27.95	\$23.95
Fiona-C	118 "	100% Polyester	None	\$37.95	\$32.95
Firefly-C	118 "	100% Polyester	None	\$23.95	\$19.95
Fishery-C	118 "	100% Polyester	None	\$27.50	\$23.50
Fizz-C	118 "	100% Polyester	None	\$37.95	\$32.95
Fizzle-C	118 "	100% Polyester	0.63 H (RR)	\$27.50	\$23.50
Flanders-C	118 "	100% Polyester	1.13 H (RR)	\$31.95	\$26.95
Flare-C	118 "	100% Polyester FR	None	\$29.95	\$25.95
Flashy-C	118 "	100% Polyester	8 V / 6.63 H (RR)	\$27.50	\$23.50
Flat Top-C	118 "	100% Polyester FR	1.75 H (RR)	\$26.45	\$22.45
Flesh-C	118 "	100% Polyester FR	8 H (RR)	\$31.45	\$26.45
Flex-C	118 "	100% Polyester	None	\$27.95	\$23.95
Float-C	118 "	100% Polyester FR	None	\$18.95	\$14.95
Flora-C	118 "	100% Polyester FR	None	\$37.95	\$32.95
Flown-C	118 "	100% Polyester FR	None	\$35.95	\$30.95
Fluid-C	118 "	100% Polyester FR	None	\$9.95	\$6.95

Drapery Fabrics

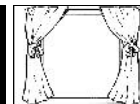

*Please note: all of our drapery prints are available on various alternate base cloths. For Crypton base cloths the minimum order required is 5 yards. For drapery weight alternate base cloths the minimum order required is 75 yards.

Pattern Name	Width	Product Data	Repeat (Inches)	Cut Price	Bolt Price
Flurry-C	118 "	65% Polyester - 35% Rayon	18 V / 12 H (RR)	\$32.95	\$27.95
Flute-C	118 "	100% Polyester FR	3.63 H (RR)	\$26.95	\$22.95
Folly-C	108 "	100% Polyester FR	12 V / 3.125 H (RR)	\$39.95	\$34.95
Fonda-C	118 "	100% Polyester FR	None	\$23.95	\$19.95
Fool-C	118 "	100% Polyester FR	None	\$25.95	\$21.95
Foolish-C	118 "	100% Polyester	10 H (RR)	\$24.95	\$20.95
Foray-C	118 "	100% Polyester	10 H (RR)	\$27.50	\$23.50
Forces-C	118 "	100% Polyester FR	None	\$39.95	\$34.95
Ford-C	118 "	100% Polyester FR	4.375 V / 4.25 H (RR)	\$20.45	\$16.45
Forecast-C	118 "	100% Polyester	9.5 H (RR)	\$29.95	\$24.95
Forsetta-C	118 "	100% Polyester FR	None	\$23.95	\$19.95
Fortune-C	118 "	100% Polyester	9 H (RR)	\$29.95	\$24.95
Forum-C	118 "	100% Polyester FR	5.5 V / 12.5 H (RR)	\$24.95	\$20.95
Fossil-C	118 "	100% Polyester	2 H (RR)	\$31.95	\$26.95
Fox-C	118 "	100% Polyester FR	15.5 V / 15.5 H (RR)	\$40.95	\$35.95
Foxglove-C	118 "	100% Polyester	8 H (RR)	\$29.95	\$24.95
Foxy-C	118 "	100% Polyester FR	None	\$38.95	\$33.95
Fraction-C	118 "	100% Polyester FR	None	\$39.95	\$34.95
Fragrant-C	118 "	100% Polyester FR	None	\$29.95	\$24.95
Franc-C	118 "	100% Polyester FR	1 V / 3 H (RR)	\$30.45	\$25.45
Frazzle-C	118 "	100% Polyester FR	None	\$31.45	\$26.45
Freedom-C	118 "	100% Polyester	None	\$27.50	\$23.50
Freon-C	118 "	100% Polyester FR	1.5 H (RR)	\$25.45	\$21.45
Freud-C	118 "	100% Polyester FR	None	\$23.45	\$19.45
Friedan-C	118 "	100% Polyester FR	13.5 H (RR)	\$27.70	\$22.70
Friend-C	118 "	100% Polyester FR	None	\$18.95	\$15.95
Frills-C	118 "	100% Polyester FR	None	\$35.95	\$30.95
Fronde-C	118 "	100% Polyester	23 V / 21.5 H (RR)	\$13.95	\$11.95
Fun-C	118 "	65% Polyester - 35% Rayon	43.5 V / 25.5 H (RR)	\$33.95	\$28.95
* Gaiety-C (On Greenwood PFP)	54 "	100% Recycled Polyester FR	9 V / 9 H	\$20.95	\$16.95
* Galahad-C (On Greenfield PFP)	54 "	100% Recycled Polyester FR	7 V	\$20.95	\$16.95
* Gearbox-C (On Greenwood PFP)	54 "	100% Recycled Polyester FR	10.5 V / 9 H	\$20.95	\$16.95
* Genesis-C (On Greenwood PFP)	54 "	100% Recycled Polyester FR	18 V / 18 H	\$20.95	\$16.95
* Gentry-C (On Greenfield PFP)	54 "	100% Recycled Polyester FR	6.75 V / 6.75 H	\$20.95	\$16.95
* Giggle-C (On Greenwood PFP)	54 "	100% Recycled Polyester FR	18 H	\$20.95	\$16.95
* Glance-C (On Greenwood PFP)	54 "	100% Recycled Polyester FR	None	\$20.95	\$16.95

Drapery Fabrics

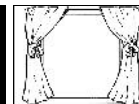

*Please note: all of our drapery prints are available on various alternate base cloths. For Crypton base cloths the minimum order required is 5 yards. For drapery weight alternate base cloths the minimum order required is 75 yards.

Pattern Name	Width	Product Data	Repeat (Inches)	Cut Price	Bolt Price
* Glimmer-C (On Greenwood PFP)	54 "	100% Recycled Polyester FR	18 V / 9 H	\$20.95	\$16.95
* Glorious-C (On Greenwood PFP)	54 "	100% Recycled Polyester FR	27 V / 27 H	\$20.95	\$16.95
* Grandeur-C (On Greenfield PFP)	54 "	100% Recycled Polyester FR	27 V / 27 H	\$20.95	\$16.95
* Guru-C (On Greenwood PFP)	54 "	100% Recycled Polyester FR	0.75 V / 13.5 H	\$20.95	\$16.95
* Halifax-C (On Ballet PFP)	54 "	100% Polyester FR	6 V / 6 H	\$20.95	\$16.95
* Hamilton-C (On Greenwood PFP)	54 "	100% Recycled Polyester FR	27 V / 27 H	\$20.95	\$16.95
* Harrison-C (On Soprano PFP)	54 "	100% Polyester FR	27 V / 27 H	\$18.45	\$14.45
* Havana-C (On Greenwood PFP)	54 "	100% Recycled Polyester FR	25 V / 12 H	\$20.95	\$16.95
Haven	72 "	100% Polyester Hybrid FR	9 V / 30.25 H (RR)	\$34.95	\$29.95
* Helix-C (On Ballet PFP)	54 "	100% Polyester FR	4.5 V / 4.5 H	\$20.95	\$16.95
* Hickory-C (On Greenwood PFP)	54 "	100% Recycled Polyester FR	None	\$20.95	\$16.95
Highland	"	100% Polyester Inherent FR	None	\$23.45	\$18.45
* Honesty-C (On Ballet PFP)	54 "	100% Polyester FR	27 V / 27 H	\$20.95	\$16.95
* Houston-C (On Soprano PFP)	54 "	100% Polyester FR	None	\$18.45	\$14.45
* Huntington-C (On Soprano PFP)	54 "	100% Polyester FR	None	\$18.45	\$14.45
Hyde Park-C	116 "	100% Polyesyter FR	12 V / 12 H (RR)	\$23.95	\$19.95
Ideal	72 "	100% Polyester FR Blend with Antimicrobial Finish	1 V / 1 H	\$16.20	\$12.20
Illustrious-C	54 "	100% Polyester FR Blend	None	\$24.95	\$19.95
Inland	72 "	100% Polyester FR Blend with Antimicrobial Finish	1.75 V / 3 H	\$17.70	\$13.70
Kate	60 "	100% Polyester FR	None	\$18.95	\$15.95
Le Cirque-C	58 "	100% Polyester FR Blend	3.75 V / 3.75 H	\$20.45	\$16.45
Liteless - Natural	60 "	100% Polyester FR	None	\$7.00	\$6.00
Madison Avenue-C	58 "	100% Polyester FR Blend	5.75 H	\$20.45	\$16.45
Maguire	54 "	100% Polyester FR Blend	None	\$23.45	\$19.45
Manchester	54 "	100% Polyester FR	None	\$20.95	\$16.95
Maritsa	72 "	100% Inherent Polyester FR	9.25 V / 15 H (RR)	\$39.45	\$34.45
Markham	72 "	100% Inherent Polyester FR	35.3 V / 37 H	\$42.95	\$37.95
Marquette	72 "	100% Inherent Polyester FR	34 V / 37 H	\$42.95	\$37.95
Maze-C	54 "	100% Polyester FR Blend	2.5 V / 2.75 H	\$23.95	\$19.95
Meridian	74 "	67% FR Polyester - 33% Recycled Polyester/ InCase Stain Repellant-Antimicrobial Treatment	9.5 V / 7.5 H (RR)	\$47.95	\$42.95
Merry-C	54 "	100% Polyester FR Blend	None	\$24.95	\$19.95
Metro	72 "	50% Polyester - 50% Inherent FR Recycled Polyester / InCase Stain Repellant- Antimicrobial Treatment	29 V / 28 H (RR)	\$44.45	\$39.45

Drapery Fabrics

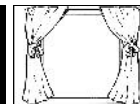

*Please note: all of our drapery prints are available on various alternate base cloths. For Crypton base cloths the minimum order required is 5 yards. For drapery weight alternate base cloths the minimum order required is 75 yards.

Pattern Name	Width	Product Data	Repeat (Inches)	Cut Price	Bolt Price
Ming	72 "	50% Polyester - 50% FR Recycled Polyester / In Case Stain/Water Repellent-Antimicrobial Treatment	72 V / 51 H (RR)	\$45.45	\$40.45
Mirage	72 "	100% Polyester Hybrid FR	12 V / 37 H (RR)	\$34.95	\$29.95
Mondrian	74 "	60% Trevira Polyester - 40% Recycled Polyester/ InCase Stain Repellent-Antimicrobial Treatment	12 V / 13.5 H (RR)	\$38.95	\$33.95
* Narcissist-C (On Medley PFP)	58 "	100% Polyester FR Hybrid	13.5 V / 9 H	\$19.45	\$15.45
* Natalie (On Medley PFP)	58 "	100% Polyester FR Hybrid	None	\$19.45	\$15.45
* Nexus-C (On Medley PFP)	58 "	100% Polyester FR Hybrid	None	\$19.45	\$15.45
* Nirvana-C (On Medley PFP)	58 "	100% Polyester FR Hybrid	18 V / 18 H	\$19.45	\$15.45
* Nonpareil-C (On Medley PFP)	58 "	100% Polyester FR Hybrid	18 V / 18 H	\$19.45	\$15.45
Palatial-C	54 "	100% Polyester FR Blend	None	\$24.95	\$19.95
Pique-C	72 "	100% Polyester FR Blend	0.25 V / 0.25 H	\$21.95	\$17.95
Precision-C	54 "	100% Polyester FR Blend	2.25 H	\$23.95	\$19.95
Providence	54 "	100% Polyester FR	None	\$18.95	\$14.95
Rio-C	116 "	100% Polyester FR	None	\$23.95	\$19.95
Rockefeller-C	58 "	100% Polyester FR Blend	None	\$23.95	\$19.95
Rumson	54 "	100% Polyester FR	None	\$23.00	\$19.00
Seurat-C	54 "	100% Polyester FR Blend	None	\$24.95	\$19.95
Siam-C	116 "	100% Polyester FR	12 V / 12 H (RR)	\$23.95	\$19.95
Soho-C	54 "	100% Polyester FR Blend	7 V / 7 H	\$23.95	\$19.95
Sublime-C	54 "	100% Polyester FR Blend	None	\$24.95	\$19.95
Sumptuous	54 "	100% Polyester	None	\$21.95	\$17.95
Text	54 "	100% Polyester FR	None	\$18.95	\$15.95
Tiffany-C	58 "	100% Polyester FR Blend	9 V / 11.75 H	\$20.45	\$16.45
* Tino (On Medley PFP)	58 "	100% Polyester FR Hybrid	None	\$19.45	\$15.45
Trafalgar Square-C	116 "	100% Polyester FR	12 V / 12 H (RR)	\$23.95	\$19.95
Trianon-C	54 "	100% Polyester FR Blend	None	\$24.95	\$19.95
Ultra	72 "	100% Polyester FR / Antimicrobial Finish	None	\$17.45	\$13.45
Ulysses	72 "	100% Polyester FR / Antimicrobial Finish	12 V / 12.5 H (RR)	\$17.45	\$13.45
Umbria	72 "	100% Polyester FR Blend with Antimicrobial Finish	23.5 V / 13.5 H (RR)	\$22.45	\$18.45
Universe-C	118 "	100% Polyester FR	None	\$23.95	\$19.95
Utopia	72 "	100% Polyester FR Blend with Antimicrobial Finish	0.75 V / 3 H (RR)	\$17.25	\$13.25
* Veronica (On Medley PFP)	58 "	100% Polyester FR Hybrid	None	\$19.45	\$15.45
Wilshire-C	54 "	100% Polyester FR Blend	None	\$24.95	\$19.95

Drapery Fabrics

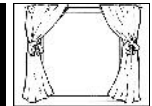

*Please note: all of our drapery prints are available on various alternate base cloths. For Crypton base cloths the minimum order required is 5 yards. For drapery weight alternate base cloths the minimum order required is 75 yards.

Pattern Name	Width	Product Data	Repeat (Inches)	Cut Price	Bolt Price
Zany-C	54 "	100% Polyester FR Blend	13.5 V / 13.5 H	\$23.95	\$19.95

Drapery Linings

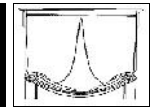

Pattern Name	Width	Product Data	Repeat (Inches)	Cut Price	Bolt Price
Eclipse-C	57 "	100% Polyester FR - 3 Pass Blackout	None	\$8.25	\$6.25
Lebois	54 "	100% Recycled Polyester FR	None	\$5.50	\$3.50
Lictor	56 "	100% Inherent Polyester FR	None	\$6.95	\$4.95
Light Control	54 "	70% Polyester - 30% Cotton	None	\$7.25	\$5.25
Lights Out	54 "	70% Polyester - 30% Cotton	None	\$7.95	\$5.95
Nitesuede Fr 2p	54 "	70% Polyester - 30% Cotton - 2 Pass Blackout	None	\$6.95	\$4.95
Nitesuede Fr 3p	54 "	70% Polyester - 30% Cotton	None	\$7.50	\$5.50



Pattern Name	Width	Product Data	Repeat (Inches)	Cut Price	Bolt Price
Bliss	72 "	100% Polyester Hybrid FR	36.5 V / 19 H (RR)	\$34.95	\$29.95
Canopy	72 "	100% Polyester Hybrid FR	24 V / 20 H (RR)	\$38.95	\$33.95
Carnival Net 3	22 "	100% Nylon FR / Antimicrobial	None	\$5.00	\$3.50
Carnival Net 3 - White	22 "	100% Nylon FR / Antimicrobial	None	\$4.50	\$2.95
* Ecliptic/Embellish DS (On Greenway PFP)	54 "	55% Recycled Polyester - 45% FR Polyester	13.5 V / 27 H	\$25.45	\$20.45
* Effervesce/Elixir DS (On Greenway PFP)	54 "	55% Recycled Polyester - 45% FR Polyester	None	\$25.45	\$20.45
* Electron/Elixir DS (On Greenway PFP)	54 "	55% Recycled Polyester - 45% FR Polyester	None	\$25.45	\$20.45
Haven	72 "	100% Polyester Hybrid FR	9 V / 30.25 H (RR)	\$34.95	\$29.95
Hyde Park-C	116 "	100% Polyesyter FR	12 V / 12 H (RR)	\$23.95	\$19.95
Ideal	72 "	100% Polyester FR Blend with Antimicrobial Finish	1 V / 1 H	\$16.20	\$12.20
Inland	72 "	100% Polyester FR Blend with Antimicrobial Finish	1.75 V / 3 H	\$17.70	\$13.70
Maritsa	72 "	100% Inherent Polyester FR	9.25 V / 15 H (RR)	\$39.45	\$34.45
Markham	72 "	100% Inherent Polyester FR	35.3 V / 37 H	\$42.95	\$37.95
Marquette	72 "	100% Inherent Polyester FR	34 V / 37 H	\$42.95	\$37.95
Meridian	74 "	67% FR Polyester - 33% Recycled Polyester/ InCase Stain Repellant-Antimicrobial Treatment	9.5 V / 7.5 H (RR)	\$47.95	\$42.95
Metro	72 "	50% Polyester - 50% Inherent FR Recycled Polyester / InCase Stain Repellant- Antimicrobial Treatment	29 V / 28 H (RR)	\$44.45	\$39.45
Ming	72 "	50% Polyester - 50% FR Recycled Polyester / In Case Stain/Water Repellant-Antimicrobial Treatment	72 V / 51 H (RR)	\$45.45	\$40.45
Mirage	72 "	100% Polyester Hybrid FR	12 V / 37 H (RR)	\$34.95	\$29.95
Mondrian	74 "	60% Trevira Polyester - 40% Recycled Polyester/ InCase Stain Repellant-Antimicrobial Treatment	12 V / 13.5 H (RR)	\$38.95	\$33.95
Montana	72 "	100% Polyester FR Hybrid / In Case Stain/Water Repellant- Antimicrobial Treatment	36 V / 32 H (RR)	\$41.95	\$36.95
* Reggio/Reggio DS (On Greenway PFP)	54 "	55% Recycled Polyester - 45% FR Polyester	None	\$25.45	\$20.45
Rio-C	116 "	100% Polyester FR	None	\$23.95	\$19.95
Siam-C	116 "	100% Polyester FR	12 V / 12 H (RR)	\$23.95	\$19.95
Trafalgar Square-C	116 "	100% Polyester FR	12 V / 12 H (RR)	\$23.95	\$19.95
Ultra	72 "	100% Polyester FR / Antimicrobial Finish	None	\$17.45	\$13.45
Ulysses	72 "	100% Polyester FR / Antimicrobial Finish	12 V / 12.5 H (RR)	\$17.45	\$13.45
Umbria	72 "	100% Polyester FR Blend with Antimicrobial Finish	23.5 V / 13.5 H (RR)	\$22.45	\$18.45

Cubicle Fabrics



Pattern Name	Width	Product Data	Repeat (Inches)	Cut Price	Bolt Price
Utopia	72 "	100% Polyester FR Blend with Antimicrobial Finish	0.75 V / 3 H (RR)	\$17.25	\$13.25

Shower Curtains



The Splash Collection is comprised of 72" wide decorative Dobby and Jacquard solid designs. The collection consists of ten (10) patterns in thirty-one (31) color ways. All patterns in this program are ideal for shower curtain, drapery, bed skirt and top-of-the-bed applications. In addition, all patterns are inherently flame resistant and feature anti-microbial and anti-bacterial properties. The Splash Collection may be purchased as fabric and/or a finished shower curtain. Product may also be purchased as Bath-in-a-Bag, complete with 72" fabric, liner, and hooks, assembled and ready to be installed.

Pattern Name	Width	Product Data	Repeat (Inches)	Cut Price	Bolt Price
Ideal	72 "	100% Polyester FR Blend with Antimicrobial Finish	1 V / 1 H	\$16.20	\$12.20
Inland	72 "	100% Polyester FR Blend with Antimicrobial Finish	1.75 V / 3 H	\$17.70	\$13.70
Pique-C	72 "	100% Polyester FR Blend	0.25 V / 0.25 H	\$21.95	\$17.95
Ultra	72 "	100% Polyester FR / Antimicrobial Finish	None	\$17.45	\$13.45
Ulysses	72 "	100% Polyester FR / Antimicrobial Finish	12 V / 12.5 H (RR)	\$17.45	\$13.45
Umbria	72 "	100% Polyester FR Blend with Antimicrobial Finish	23.5 V / 13.5 H (RR)	\$22.45	\$18.45
Utopia	72 "	100% Polyester FR Blend with Antimicrobial Finish	0.75 V / 3 H (RR)	\$17.25	\$13.25

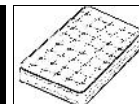

Bedding Encasement Products Quick Reference

SOFTCOVER ULTIMATE: 100% Polyester, patent pending Exclusive Zipper / Hook Lock bed bug proof locking zipper. 100% Waterproof and Dust Mite Proof on all six sides (this is best for properties that flip the mattress). They are breathable. Impermeable to Mold and Bacteria. The mattress thickness (9"- 15") must be specified when ordered. They are guaranteed for 100 launderings up to 220 degrees. They are Class "B" FR although FR is not required for this product. They are manufactured in the USA.

SOFTCOVER SUPERIOR: 100% Polyester, patent pending Exclusive Zipper / Hook Lock bed bug proof zipper. Waterproof top (from the zipper up). Protects against Bed Bugs, Dust Mites, Mold and Bacteria. They stretch to accommodate any mattress thickness from (9"-15"). They are guaranteed for 100 launderings up to 220 degrees. They are Class "B" FR, although FR is not required for this product. This product is manufactured in the USA and/or imported.

KLEENCOVER SUPERIOR: 100% Polyester, patent pending Exclusive Zipper / Hook Lock bed bug proof locking zipper. Waterproof top (from the zipper up). Protects against Bed Bugs, Dust Mites, Mold and Bacteria. They stretch to accommodate any mattress thickness from (9"-15"). They are guaranteed for 50 launderings up to 120 degrees. This product is imported.

BED BUG PROOF BOX SPRING COVER: 100% Polypropylene Total Encasement. Exclusive Zipper / Hook Lock. Protects against Bed Bugs, Dust Mites, Mold and Bacteria. This product is imported.

KLEENCOVER PILLOWSAFE: 100% Polyester. Total pillow encasement. Waterproof, Breathable, Non-Allergenic, Bed Bug Proof, Impermeable to Dust Mites, Mold and Bacteria. This product is imported.

Bedding Encasement Products

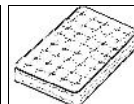

Mattress Protector	Size	Quantities	
		1-199	200 +
SofCover FR Ultimate 9"	Twin - 39 x 75	\$70.95	\$67.50
SofCover FR Ultimate 9"	Twin XL - 39 x 80	\$70.95	\$67.50
SofCover FR Ultimate 9"	Full - 54 x 75	\$73.50	\$69.95
SofCover FR Ultimate 9"	Full XL - 54 x 80	\$73.50	\$69.95
SofCover FR Ultimate 9"	Queen - 60 x 80	\$78.95	\$74.95
SofCover FR Ultimate 9"	King - 78 x 80	\$101.95	\$96.95
SofCover FR Ultimate 9"	Cal. King - 72 x 84	\$101.95	\$96.95
SofCover FR Ultimate 12"	Twin - 39 x 75	\$73.50	\$69.95
SofCover FR Ultimate 12"	Twin XL - 39 x 80	\$73.50	\$69.95
SofCover FR Ultimate 12"	Full - 54 x 75	\$77.50	\$73.95
SofCover FR Ultimate 12"	Full XL - 54 x 80	\$80.95	\$77.50
SofCover FR Ultimate 12"	Queen - 60 x 80	\$87.95	\$83.95
SofCover FR Ultimate 12"	King - 78 x 80	\$111.95	\$106.50
SofCover FR Ultimate 12"	Cal. King - 72 x 84	\$111.95	\$106.50
SofCover FR Ultimate 15"	Twin - 39 x 75	\$73.50	\$69.95
SofCover FR Ultimate 15"	Twin XL - 39 x 80	\$77.50	\$73.95
SofCover FR Ultimate 15"	Full - 54 x 75	\$77.50	\$73.95
SofCover FR Ultimate 15"	Full XL - 54 x 80	\$80.95	\$77.50
SofCover FR Ultimate 15"	Queen - 60 x 80	\$87.95	\$83.95
SofCover FR Ultimate 15"	King - 78 x 80	\$111.95	\$106.50
SofCover FR Ultimate 15"	Cal. King - 72 x 84	\$111.95	\$106.50
Sofcover FR Superior 9-15" Deep	Twin Plus - 39 x 75-80	\$62.95	\$59.50
Sofcover FR Superior 9-15" Deep	Full Plus - 54 x 75-80	\$66.95	\$63.50
Sofcover FR Superior 9-15" Deep	Queen - 60 x 80	\$70.50	\$66.95
Sofcover FR Superior 9-15" Deep	King - 78 x 80	\$80.50	\$76.95
Sofcover FR Superior 9-15" Deep	Cal. King - 72 x 84	\$80.50	\$76.95
KleenCover Superior 9-15" Deep	Twin Plus - 39 x 75-80	\$34.50	\$32.95
KleenCover Superior 9-15" Deep	Full Plus - 54 x 75-80	\$44.50	\$42.50
KleenCover Superior 9-15" Deep	Queen - 60 x 80	\$47.95	\$45.50
KleenCover Superior 9-15" Deep	King - 78 x 80	\$55.50	\$52.95
KleenCover Superior 9-15" Deep	Cal. King - 72 x 84	\$52.50	\$49.95
Box Spring Cover Superior 9-15" Deep	Twin Plus - 39 x 75-80	\$29.95	\$28.50
Box Spring Cover Superior 9-15" Deep	Full Plus - 54 x 75-80	\$35.50	\$33.95
Box Spring Cover Superior 9-15" Deep	Queen - 60 x 80	\$37.50	\$36.50
Box Spring Cover Superior 9-15" Deep	King - 78 x 80	\$44.95	\$42.95
Box Spring Cover Superior 9-15" Deep	Cal. King - 72 x 84	\$44.95	\$42.95
Pillow Protector	Standard	\$11.50	\$10.95
Pillow Protector	Queen	\$12.50	\$11.95
Pillow Protector	King	\$13.95	\$12.95

LIMITED AVAILABILITY

Inventories of the following patterns are available for at once shipping while supplies last. Patterns or colors not in stock may still be available on a special order basis by contacting your salesperson or our customer service department for minimums, delivery and price.

PRINTED PATTERNS WITH *

Depending on heat transfer paper availability, these patterns can be printed on any of our drapery weight print cloths. Please contact your local representative or our New York office for assistance.

Limited Availability ... Upholstery Fabrics



The following patterns are available for at once shipping while supplies last. Patterns not in stock may still be available on a special order basis by contacting your salesperson or our customer service department for minimums, delivery and pricing.

Pattern Name	Width	Product Data	Repeat (Inches)	Cut Price	Bolt Price
Alistair-C	54 "	94% Polyester- 6% Acrylic / Soil And Stain Finish And Acrylic Backing	1 V / 13.25 H (RR)	\$28.95	\$23.95
Animal-C/U	54 "	100% Polyester FR Blend / Acrylic Backing / Soil And Stain Repellent Finish	14.75 V / 14 H	\$25.95	\$21.95
Bullseye-C/U	54 "	100% Polyester FR Blend / Acrylic Backing / Soil And Stain Repellent Finish	8.75 V / 14 H	\$25.95	\$21.95
Capricia-C	54 "	100% Recycled Polyester / Acrylic Backing / Soil And Stain Repellent Finish	2.25 V / 2 H (RR)	\$36.95	\$31.95
Chain LinkC/U	54 "	100% Polyester FR Blend / Acrylic Backing / Soil And Stain Repellent Finish	13 V / 14 H	\$25.95	\$21.95
Charles-C	54 "	90%Polyester -10% Acrylic / Soil And Stain Finish And Acrylic Backing	0.38 V / 0.63 H (RR)	\$33.45	\$28.45
Chase-C/U	54 "	100% Polyester FR Blend / Acrylic Backing / Soil And Stain Repellent Finish	None	\$25.95	\$21.95
Chummy-C (On Cozy Honey)	54 "	100% Polyester / Polyester Cotton Backing	None	\$29.45	\$24.45
Chummy-C (On Cozy Goldenrod)	54 "	100% Polyester / Polyester Cotton Backing	None	\$29.45	\$24.45
Classy-C (On Cozy Goldenrod)	54 "	100% Polyester / Polyester Cotton Backing	1.5 V	\$27.95	\$22.95
Classy-C (On Cozy Honey)	54 "	100% Polyester / Polyester Cotton Backing	1.5 V	\$27.95	\$22.95
Clovis-C	54 "	51% Olefin- 49% Polyester / Soil And Stain Finish And Acrylic Backing	0.88 V / 3 H (RR)	\$32.95	\$27.95
Cody-C (On Cozy Honey)	54 "	100% Polyester / Polyester Cotton Backing	None	\$29.45	\$24.45
Cody-C (On Cozy Goldenrod)	54 "	100% Polyester / Polyester Cotton Backing	None	\$29.45	\$24.45
Conrad-C	54 "	98% Polyester - 2% Cotton / Soil And Stain Finish And Acrylic Backing	1.5 H (RR)	\$33.95	\$28.95
Cookie-C (On Cozy Goldenrod)	54 "	100% Polyester / Polyester Cotton Backing	13.5 H	\$29.45	\$24.45
Cubby-C (On Cozy Honey)	54 "	100% Polyester / Polyester Cotton Backing	13.5 H	\$29.45	\$24.45
Cubby-C (On Cozy Goldenrod)	54 "	100% Polyester / Polyester Cotton Backing	13.5 H	\$29.45	\$24.45
Curly-C (On Cozy Honey)	54 "	100% Polyester / Polyester Cotton Backing	None	\$29.45	\$24.45
Curly-C (On Cozy Goldenrod)	54 "	100% Polyester / Polyester Cotton Backing	None	\$29.45	\$24.45
Cutesy-C (On Cozy Goldenrod)	54 "	100% Polyester / Polyester Cotton Backing	None	\$29.45	\$24.45
Edward-C	54 "	94% Polyester - 6% Acrylic / Soil And Stain Finish And Acrylic Backing	2 V / 1.75 H (RR)	\$30.45	\$25.45
Erik-C	54 "	74% Polyester -26% Cotton / Soil And Stain Finish And Acrylic Backing	7 V / 9 H (RR)	\$35.45	\$30.45
Femme Fatale-C/U	54 "	100% Polyester FR Blend / Acrylic Backing / Soil And Stain Repellent Finish	7.75 V / 7 H	\$25.95	\$21.95
Gauntlet	54 "	58% Recycled Polyester - 42% Olefin/ Crypton	7 V / 7.38 H (RR)	\$47.45	\$42.45
Green Heart	54 "	100% Recycled Polyester / Crypton	7 V / 13.5 H (RR)	\$40.95	\$35.95
Gridlock	54 "	100% Recycled Polyester / Crypton	4.75 V / 6.63 H (RR)	\$40.95	\$35.95
Grindstone	54 "	100% Recycled Polyester / Crypton	9.25 V / 7 H (RR)	\$40.95	\$35.95

Limited Availability ... Upholstery Fabrics



The following patterns are available for at once shipping while supplies last. Patterns not in stock may still be available on a special order basis by contacting your salesperson or our customer service department for minimums, delivery and pricing.

Pattern Name	Width	Product Data	Repeat (Inches)	Cut Price	Bolt Price
Henry-C	54 "	100% Polyester / Soil And Stain Finish And Acrylic Backing	0.625 V / 2.75 H (RR)	\$41.95	\$36.95
Hunter-C/U	54 "	100% Polyester FR Blend / Acrylic Backing / Soil And Stain Repellent Finish	8 V / 7 H	\$25.95	\$21.95
Jail Bird-C/U	54 "	100% Polyester FR Blend / Acrylic Backing / Soil And Stain Repellent Finish	16.5 V / 14 H	\$25.95	\$21.95
Oleg-C	54 "	73% Polyester-20%Cotton-6% Rayon-1% Metallic / Soil And Stain Finish And Acrylic Backing	6 H (RR)	\$33.45	\$28.45
Outlaw-C/U	54 "	100% Polyester FR Blend / Acrylic Backing / Soil And Stain Repellent Finish	None	\$25.95	\$21.95
Pace	54 "	100% Polyester / Crypton	None	\$32.45	\$27.45
* Paddock (On Serenade PFP)	58 "	100% Polyester FR Hybrid / Crypton	None	\$24.95	\$20.95
* Pageant (On Serenade PFP)	58 "	100% Polyester FR Hybrid / Crypton	None	\$24.95	\$20.95
Palace	54 "	100% Polyester / Crypton	None	\$46.45	\$40.95
* Palatine (On Serenade PFP)	58 "	100% Polyester FR Hybrid / Crypton	None	\$24.95	\$20.95
Paris	57 "	45% Nylon - 36% Polyester -19%Cotton / Failsafe Finish	None	\$36.45	\$31.45
Raleigh	54 "	100% Polyester / Crypton	None	\$24.95	\$19.95
Renegade-C/U	54 "	100% Polyester FR Blend / Acrylic Backing / Soil And Stain Repellent Finish	None	\$25.95	\$21.95
Rogue-C/U	54 "	100% Polyester FR Blend / Acrylic Backing / Soil And Stain Repellent Finish	None	\$25.95	\$21.95
Rudolph-C	54 "	61% Rayon- 39% Polyester / Soil And Stain Finish And Acrylic Backing	0.5 V (RR)	\$35.45	\$30.45
Sambuca	54 "	51% Acrylic-49% Polyester/Crypton	7.75 V / 4.75 H (RR)	\$32.45	\$27.45
Shore-C	54 "	100% Solution Dyed Acrylic	None	\$23.95	\$19.95
Target-C/U	54 "	100% Polyester FR Blend / Acrylic Backing / Soil And Stain Repellent Finish	6 V / 7 H	\$25.95	\$21.95
Vabyn	54 "	100% PVC Face / 100% Polyester Backing	None	\$12.45	\$10.45
Vanderbilt	54 "	100% PVC Face / Polyester Rayon Blend Backing	None	\$28.95	\$23.95
Varney	54 "	PVC-Rayon Blend Face / 100% Polyester Backing	None	\$16.95	\$12.95
Vayard	54 "	100% PVC Face / Polyester Rayon Blend Backing	None	\$22.95	\$18.95
Vivante	54 "	100% PVC Face	None	\$25.45	\$20.45
William-C	54 "	100% Polyester	6.75 V / 4.2 H (RR)	\$36.95	\$31.95

Limited Availability ... Vinyl Upholstery



The following patterns are available for at once shipping while supplies last. Patterns not in stock may still be available on a special order basis by contacting your salesperson or our customer service department for minimums, delivery and pricing.

Pattern Name	Width	Product Data	Repeat (Inches)	Cut Price	Bolt Price
Vabyn	54 "	100% PVC Face / 100% Polyester Backing	None	\$12.45	\$10.45
Vanderbilt	54 "	100% PVC Face / Polyester Rayon Blend Backing	None	\$28.95	\$23.95
Varney	54 "	PVC-Rayon Blend Face / 100% Polyester Backing	None	\$16.95	\$12.95
Vayard	54 "	100% PVC Face / Polyester Rayon Blend Backing	None	\$22.95	\$18.95
Vivante	54 "	100% PVC Face	None	\$25.45	\$20.45

Limited Availability ... Barrier Upholstery



The following patterns are available for at once shipping while supplies last. Patterns not in stock may still be available on a special order basis by contacting your salesperson or our customer service department for minimums, delivery and pricing.

Pattern Name	Width	Product Data	Repeat (Inches)	Cut Price	Bolt Price
Gauntlet	54 "	58% Recycled Polyester - 42% Olefin/ Crypton	7 V / 7.38 H (RR)	\$47.45	\$42.45
Green Heart	54 "	100% Recycled Polyester / Crypton	7 V / 13.5 H (RR)	\$40.95	\$35.95
Gridlock	54 "	100% Recycled Polyester / Crypton	4.75 V / 6.63 H (RR)	\$40.95	\$35.95
Grindstone	54 "	100% Recycled Polyester / Crypton	9.25 V / 7 H (RR)	\$40.95	\$35.95
Pace	54 "	100% Polyester / Crypton	None	\$32.45	\$27.45
* Paddock (On Serenade PFP)	58 "	100% Polyester FR Hybrid / Crypton	None	\$24.95	\$20.95
* Pageant (On Serenade PFP)	58 "	100% Polyester FR Hybrid / Crypton	None	\$24.95	\$20.95
Palace	54 "	100% Polyester / Crypton	None	\$46.45	\$40.95
* Palatine (On Serenade PFP)	58 "	100% Polyester FR Hybrid / Crypton	None	\$24.95	\$20.95
Paris	57 "	45% Nylon - 36% Polyester -19%Cotton / Failsafe Finish	None	\$36.45	\$31.45
Raleigh	54 "	100% Polyester / Crypton	None	\$24.95	\$19.95
Sambuca	54 "	51% Acrylic-49% Polyester/Crypton	7.75 V / 4.75 H (RR)	\$32.45	\$27.45
Vabyn	54 "	100% PVC Face / 100% Polyester Backing	None	\$12.45	\$10.45
Vanderbilt	54 "	100% PVC Face / Polyester Rayon Blend Backing	None	\$28.95	\$23.95
Varney	54 "	PVC-Rayon Blend Face / 100% Polyester Backing	None	\$16.95	\$12.95
Vayard	54 "	100% PVC Face / Polyester Rayon Blend Backing	None	\$22.95	\$18.95
Vivante	54 "	100% PVC Face	None	\$25.45	\$20.45

Limited Availability ... Outdoor Upholstery



The following patterns are available for at once shipping while supplies last. Patterns not in stock may still be available on a special order basis by contacting your salesperson or our customer service department for minimums, delivery and pricing.

Pattern Name	Width	Product Data	Repeat (Inches)	Cut Price	Bolt Price
Shore-C	54 "	100% Solution Dyed Acrylic	None	\$23.95	\$19.95

Limited Availability ... Eco Drapery



The following patterns are available for at once shipping while supplies last. Patterns not in stock may still be available on a special order basis by contacting your salesperson or our customer service department for minimums, delivery and pricing.

Pattern Name	Width	Product Data	Repeat (Inches)	Cut Price	Bolt Price
* Damascus-C (On Greenfield PFP)	54 "	100% Recycled Polyester FR	18.5 V / 18 H	\$20.95	\$16.95
* Dappled-C (On Greenland PFP)	54 "	100% Recycled Polyester FR	27 V / 18 H	\$21.45	\$17.45
* Daybreak-C (On Greenwood PFP)	54 "	100% Recycled Polyester FR	25 V / 27 H	\$20.95	\$16.95
* Decimal-C (On Greenwood PFP)	54 "	100% Recycled Polyester FR	5.25 V / 3.625 H	\$20.95	\$16.95
* Decoupage-C (On Greenwood PFP)	54 "	100% Recycled Polyester FR	25 V / 27 H	\$20.95	\$16.95
* Delight-C (On Greenfield PFP)	54 "	100% Recycled Polyester FR	12.5 V / 12.25 H	\$20.95	\$16.95
* Destiny-C (On Greenwood PFP)	54 "	100% Recycled Polyester FR	9 H	\$20.95	\$16.95
* Dimension-C (On Greenwood PFP)	54 "	100% Recycled Polyester FR	9 H	\$20.95	\$16.95
* Distinctive-C (On Greenwood PFP)	54 "	100% Recycled Polyester FR	25 V / 13.5 H	\$20.95	\$16.95
* Dominant-C (On Greenland PFP)	54 "	100% Recycled Polyester FR	13.5 V / 21 H	\$21.45	\$17.45
* Doodle-C (On Greenland PFP)	54 "	100% Recycled Polyester FR	27 V / 27 H	\$21.45	\$17.45
* Drummer-C (On Greenland PFP)	54 "	100% Recycled Polyester FR	13.5 H	\$21.45	\$17.45
* Panache-C (On Greenland PFP)	54 "	100% Recycled Polyester FR	1.8 V / 1.8 H	\$21.45	\$17.45
* Paradise-C (On Greenwood PFP)	54 "	100% Recycled Polyester FR	27 V / 13.5 H	\$20.95	\$16.95
* Paragon-C (On Greenwood PFP)	54 "	100% Recycled Polyester FR	27 V / 6 H	\$20.95	\$16.95
* Parson-C (On Greenland PFP)	54 "	100% Recycled Polyester FR	2.25 V / 1.25 H	\$21.45	\$17.45
* Pasha-C (On Greenwood PFP)	54 "	100% Recycled Polyester FR	18 V / 18 H	\$20.95	\$16.95
* Paterson-C (On Greenland PFP)	54 "	100% Recycled Polyester FR	27 V / 54 H	\$21.45	\$17.45
* Patriot-C (On Greenland PFP)	54 "	100% Recycled Polyester FR	5.375 H	\$21.45	\$17.45
* Piccolo-C (On Greenfield PFP)	54 "	100% Recycled Polyester FR	6 V / 6 H	\$20.95	\$16.95
* Pillar-C (On Greenfield PFP)	54 "	100% Recycled Polyester FR	18 H	\$20.95	\$16.95
* Pirouette-C (On Greenfield PFP)	54 "	100% Recycled Polyester FR	18 V / 6.75 H	\$20.95	\$16.95

Limited Availability ... Drapery Fabrics

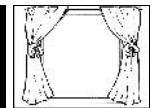

The following patterns are available for at once shipping while supplies last. Patterns not in stock may still be available on a special order basis by contacting your salesperson or our customer service department for minimums, delivery and pricing.

Pattern Name	Width	Product Data	Repeat (Inches)	Cut Price	Bolt Price
Animal-C	54 "	100% Polyester FR Blend	14.75 V / 14 H	\$22.95	\$18.95
* Bath (On Ballet PFP)	54 "	100% Polyester FR	8.25 V / 6.75 H	\$20.45	\$16.45
Bullseye-C	54 "	100% Polyester FR Blend	8.75 V / 14 H	\$22.95	\$18.95
* Cancun-C (On Ballet PFP)	54 "	100% Polyester FR	25 V / 13.5 H	\$20.45	\$16.45
Chain Link-C	54 "	100% Polyester FR Blend	13 V / 14 H	\$22.95	\$18.95
Chase-C	54 "	100% Polyester FR Blend	None	\$22.95	\$18.95
* Chenille Rib-C (On Ballet PFP)	54 "	100% Polyester FR	None	\$20.45	\$16.45
* Consort-C (On Ballet PFP)	54 "	100% Polyester FR	None	\$20.45	\$16.45
* Culture-C (On Ballet PFP)	54 "	100% Polyester FR	25 V / 18 H	\$20.45	\$16.45
* Curves-C (On Ballet PFP)	54 "	100% Polyester FR	25 V / 13.5 H	\$20.45	\$16.45
* Damascus-C (On Greenfield PFP)	54 "	100% Recycled Polyester FR	18.5 V / 18 H	\$20.95	\$16.95
* Dappled-C (On Greenland PFP)	54 "	100% Recycled Polyester FR	27 V / 18 H	\$21.45	\$17.45
* Daybreak-C (On Greenwood PFP)	54 "	100% Recycled Polyester FR	25 V / 27 H	\$20.95	\$16.95
* Decimal-C (On Greenwood PFP)	54 "	100% Recycled Polyester FR	5.25 V / 3.625 H	\$20.95	\$16.95
* Decoupage-C (On Greenwood PFP)	54 "	100% Recycled Polyester FR	25 V / 27 H	\$20.95	\$16.95
* Delight-C (On Greenfield PFP)	54 "	100% Recycled Polyester FR	12.5 V / 12.25 H	\$20.95	\$16.95
* Destiny-C (On Greenwood PFP)	54 "	100% Recycled Polyester FR	9 H	\$20.95	\$16.95
* Dimension-C (On Greenwood PFP)	54 "	100% Recycled Polyester FR	9 H	\$20.95	\$16.95
* Distinctive-C (On Greenwood PFP)	54 "	100% Recycled Polyester FR	25 V / 13.5 H	\$20.95	\$16.95
* Dominant-C (On Greenland PFP)	54 "	100% Recycled Polyester FR	13.5 V / 21 H	\$21.45	\$17.45
* Doodle-C (On Greenland PFP)	54 "	100% Recycled Polyester FR	27 V / 27 H	\$21.45	\$17.45
* Drummer-C (On Greenland PFP)	54 "	100% Recycled Polyester FR	13.5 H	\$21.45	\$17.45
Fable-C	118 "	100% Polyester FR	11.5 H (RR)	\$30.45	\$25.45
Fabulous-C	118 "	100% Polyester FR	3.75 V (RR)	\$34.95	\$29.95
Fairchild-C	113 "	100% Polyester FR	0.5 V / 0.5 H (RR)	\$30.45	\$25.45
Fairfax-C	118 "	100% Polyester FR	5 V / 4.75 H (RR)	\$39.45	\$34.45
Faith-C	118 "	100% Polyester FR	None	\$21.95	\$17.95
Falcon-C	126 "	100% Polyester FR	11.7 V / 19 H (RR)	\$44.45	\$39.45
Falkner-C	118 "	100% Polyester FR	8.5 H (RR)	\$26.45	\$21.45
Fame-C	108 "	100% Polyester FR	8 V / 6.5 H (RR)	\$37.45	\$32.45
Famous-C	113 "	100% Polyester FR	7 H (RR)	\$34.45	\$29.45
Fancy-C	118 "	100% Polyester FR	1 V / 1 H (RR)	\$22.95	\$18.95
Fantastic-C	118 "	100% Polyester FR	1.75 V / 2.75 H (RR)	\$31.45	\$26.45
Fargo-C	118 "	100% Polyester FR	None	\$26.20	\$22.20
Fascination-C	118 "	100% Polyester FR	None	\$35.45	\$30.45
Fashion-C	108 "	100% Polyester FR	6 V / 5.75 H (RR)	\$40.45	\$35.45

Limited Availability ... Drapery Fabrics

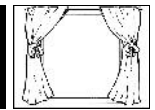

The following patterns are available for at once shipping while supplies last. Patterns not in stock may still be available on a special order basis by contacting your salesperson or our customer service department for minimums, delivery and pricing.

Pattern Name	Width	Product Data	Repeat (Inches)	Cut Price	Bolt Price
Favor-C	118 "	100% Polyester FR	10.75 H (RR)	\$30.45	\$25.45
Favorite-C	118 "	100% Polyester FR	3.75 V / 19 H (RR)	\$51.45	\$46.45
Fedora-C	118 "	100% Polyester FR	7.7 V / 9.8 H (RR)	\$46.45	\$41.45
Felicity-C	118 "	100% Polyester FR	5.75 V / 4.625 H (RR)	\$40.45	\$35.45
Fellini-C	118 "	100% Polyester FR	None	\$25.45	\$21.45
Femme Fatale-C	54 "	100% Polyester FR Blend	7.75 V / 7 H	\$22.95	\$18.95
Ferdinand-C	118 "	100% Polyester FR	None	\$35.45	\$30.45
Festive-C	118 "	100% Polyester FR	None	\$24.45	\$20.45
Finch-C	118 "	100% Polyester FR	2.1 V / 2.6 H (RR)	\$22.70	\$18.70
Firebird-C	118 "	100% Polyester FR	3.88 H (RR)	\$24.45	\$20.45
Fisher-C	118 "	100% Polyester FR	None	\$27.95	\$22.95
Flag-C	108 "	100% Polyester FR	6 V / 6 H (RR)	\$39.45	\$34.45
Flambe-C	118 "	100% Polyester FR	26 H (RR)	\$39.45	\$34.45
Flamboyant-C	118 "	100% Polyester FR	11.5 V / 5.5 H (RR)	\$52.20	\$47.20
Flamenco	118 "	100% Polyester FR	None	\$19.95	\$15.95
Flapjacks-C	118 "	100% Polyester FR	6 H (RR)	\$28.20	\$24.20
Flash-C	118 "	100% Polyester FR	7.12 H (RR)	\$21.95	\$17.95
Flavor-C	118 "	100% Polyester FR	5.25 H (RR)	\$31.45	\$26.45
Flicker-C	118 "	100% Polyester FR	None	\$27.45	\$23.45
Flight-C	118 "	100% Polyester FR	1.25 H (RR)	\$24.45	\$20.45
Fling-C	118 "	100% Polyester FR	None	\$16.45	\$12.45
Flip-C	118 "	100% Polyester FR	0.625 V / 0.625 H (RR)	\$26.45	\$22.45
Flirt-C	118 "	100% Polyester FR	3.88 H (RR)	\$24.45	\$20.45
Flourish-C	118 "	100% Polyester FR	4.25 H (RR)	\$31.95	\$26.95
Fly-C	118 "	100% Polyester FR	5.75 H (RR)	\$19.95	\$15.95
Folio-C	108 "	100% Polyester FR	9 V / 8.5 H (RR)	\$36.20	\$31.20
Folk-C	118 "	100% Polyester FR	5.75 V / 5.75 H (RR)	\$25.45	\$21.45
Forever-C	118 "	100% Polyester FR	None	\$20.95	\$16.95
Forge-C	118 "	100% Polyester FR	3 V / 3.3 H (RR)	\$26.20	\$22.20
Formal-C	118 "	100% Polyester FR	7 H (RR)	\$30.95	\$25.95
Forster-C	118 "	100% Polyester FR	5.5 V / 5.5 H (RR)	\$30.45	\$25.45
Foulard-C	118 "	100% Polyester FR	3.1 V / 5.1 H (RR)	\$40.45	\$35.45
Fragrance-C	118 "	100% Polyester FR	3.5 H (RR)	\$31.45	\$26.45
Frail-C	118 "	100% Polyester FR	15.25 H (RR)	\$31.45	\$26.45
Franco-C	118 "	100% Polyester FR	None	\$29.95	\$24.95

Limited Availability ... Drapery Fabrics

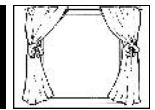

The following patterns are available for at once shipping while supplies last. Patterns not in stock may still be available on a special order basis by contacting your salesperson or our customer service department for minimums, delivery and pricing.

Pattern Name	Width	Product Data	Repeat (Inches)	Cut Price	Bolt Price
Frappe-C	118 "	100% Polyester FR	10 H (RR)	\$21.95	\$17.95
Frat-C	118 "	100% Polyester FR	None	\$26.95	\$22.95
Free-C	118 "	100% Polyester FR	4.5 V / 4.7 H (RR)	\$30.45	\$25.45
Freeze-C	118 "	100% Polyester FR	None	\$26.45	\$22.45
Fresh-C	118 "	100% Polyester FR	2 H (RR)	\$19.70	\$15.70
Frey-C	118 "	100% Polyester FR	None	\$22.70	\$18.70
Hunter-C	54 "	100% Polyester FR Blend	8 V / 7 H	\$22.95	\$18.95
Jail Bird-C	54 "	100% Polyester FR Blend	16.5 V / 14 H	\$22.95	\$18.95
* Kindness (On Soprano PFP)	54 "	100% Polyester FR	13.5 V / 27 H	\$16.95	\$12.95
Outlaw-C	54 "	100% Polyester FR Blend	None	\$22.95	\$18.95
* Panache-C (On Greenland PFP)	54 "	100% Recycled Polyester FR	1.8 V / 1.8 H	\$21.45	\$17.45
* Paradise-C (On Greenwood PFP)	54 "	100% Recycled Polyester FR	27 V / 13.5 H	\$20.95	\$16.95
* Paragon-C (On Greenwood PFP)	54 "	100% Recycled Polyester FR	27 V / 6 H	\$20.95	\$16.95
* Parson-C (On Greenland PFP)	54 "	100% Recycled Polyester FR	2.25 V / 1.25 H	\$21.45	\$17.45
* Pasha-C (On Greenwood PFP)	54 "	100% Recycled Polyester FR	18 V / 18 H	\$20.95	\$16.95
* Paterson-C (On Greenland PFP)	54 "	100% Recycled Polyester FR	27 V / 54 H	\$21.45	\$17.45
* Patriot-C (On Greenland PFP)	54 "	100% Recycled Polyester FR	5.375 H	\$21.45	\$17.45
* Piccolo-C (On Greenfield PFP)	54 "	100% Recycled Polyester FR	6 V / 6 H	\$20.95	\$16.95
* Pillar-C (On Greenfield PFP)	54 "	100% Recycled Polyester FR	18 H	\$20.95	\$16.95
* Pinwheel-C (On Ballet PFP)	54 "	100% Polyester FR	None	\$20.95	\$16.95
* Pirouette-C (On Greenfield PFP)	54 "	100% Recycled Polyester FR	18 V / 6.75 H	\$20.95	\$16.95
* Pizzazz-C (On Ballet PFP)	54 "	100% Polyester FR	None	\$20.95	\$16.95
* Quantum-C (On Ballet PFP)	54 "	100% Polyester FR	27 V / 13.5 H	\$20.45	\$16.45
* Racine-C (On Ballet PFP)	54 "	100% Polyester FR	27 V / 27 H	\$20.45	\$16.45
* Ramapo-C (On Ballet PFP)	54 "	100% Polyester FR	None	\$20.45	\$16.45
* Ravi-C (On Concerto PFP)	56 "	100% Polyester FR	None	\$19.20	\$15.20
* Reggio-C (On Ballet PFP)	54 "	100% Polyester FR	18 V / 18 H	\$20.45	\$16.45
Renegade-C	54 "	100% Polyester FR Blend	None	\$22.95	\$18.95
* Revere-C (On Ballet PFP)	54 "	100% Polyester FR	27 V / 27 H	\$20.45	\$16.45
Rogue-C	54 "	100% Polyester FR Blend	None	\$22.95	\$18.95
* Rupert-C (On Ballet PFP)	54 "	100% Polyester FR	27 V / 27 H	\$20.45	\$16.45
* Russell-C (On Ballet PFP)	54 "	100% Polyester FR	13.5 H	\$20.45	\$16.45
* Rye-C (On Ballet PFP)	54 "	100% Polyester FR	None	\$20.45	\$16.45
* Sachett Swirl-C (On Ballet PFP)	54 "	100% Polyester FR	17.25 V / 17 H	\$20.45	\$16.45
* Sachett-C (On Ballet PFP)	54 "	100% Polyester FR	17.75 V / 17.5 H	\$20.45	\$16.45
* Saga-C (On Ballet PFP)	54 "	100% Polyester FR	27 V / 13.5 H	\$20.45	\$16.45

Limited Availability ... Drapery Fabrics

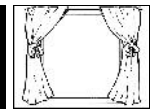

The following patterns are available for at once shipping while supplies last. Patterns not in stock may still be available on a special order basis by contacting your salesperson or our customer service department for minimums, delivery and pricing.

Pattern Name	Width	Product Data	Repeat (Inches)	Cut Price	Bolt Price
* Salient-C (On Ballet PFP)	54 "	100% Polyester FR	24 V / 27 H	\$20.45	\$16.45
* Sand Box-C (On Ballet PFP)	54 "	100% Polyester FR	18 V / 18 H	\$20.45	\$16.45
* Sapling-C (On Ballet PFP)	54 "	100% Polyester FR	2 V	\$20.45	\$16.45
Scope	72 "	100% Inherent Polyester FR	7.35 V / 7 H (RR)	\$47.00	\$42.00
Soprano	54 "	100% Polyester FR	None	\$16.95	\$12.95
* Sweetbriar Str.-C (On Ballet PFP)	54 "	100% Polyester FR	6.5 H	\$20.45	\$16.45
* Sweetbriar-C (On Ballet PFP)	54 "	100% Polyester FR	26.5 V / 26.5 H	\$20.45	\$16.45
Target-C	54 "	100% Polyester FR Blend	6 V / 7 H	\$22.95	\$18.95
* Tradition (On Ballet PFP)	54 "	100% Polyester FR	13 V / 13.5 H	\$20.45	\$16.45
* Tradition Str. (On Ballet PFP)	54 "	100% Polyester FR	None	\$20.45	\$16.45
* Tumult-C (On Ballet PFP)	54 "	100% Polyester FR	18 V / 13.5 H	\$20.45	\$16.45
* Tundra-C (On Ballet PFP)	54 "	100% Polyester FR	12.5 V / 6.75 H	\$20.45	\$16.45

Limited Availability ... Drapery Linings

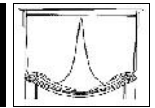

The following patterns are available for at once shipping while supplies last. Patterns not in stock may still be available on a special order basis by contacting your salesperson or our customer service department for minimums, delivery and pricing.

Pattern Name	Width	Product Data	Repeat (Inches)	Cut Price	Bolt Price
Liason	57 "	100% Polyester FR	None	\$5.50	\$3.50
Liason - Ivory	57 "	100% Polyester FR	None	\$5.50	\$3.50
Liason - White	57 "	100% Polyester FR	None	\$5.00	\$3.00

Limited Availability ... Cubicle Fabrics



The following patterns are available for at once shipping while supplies last. Patterns not in stock may still be available on a special order basis by contacting your salesperson or our customer service department for minimums, delivery and pricing.

Pattern Name	Width	Product Data	Repeat (Inches)	Cut Price	Bolt Price
* Distinctive/Decimal DS (On Greenway PFP)	54 "	55% Recycled Polyester - 45% FR Polyester	None	\$25.45	\$20.45
* Pandora/Panache DS (On Greenway PFP)	54 "	55% Recycled Polyester - 45% FR Polyester	27 V / 27 H	\$25.45	\$20.45
* Paradise/Paragon DS (On Greenway PFP)	54 "	55% Recycled Polyester - 45% FR Polyester	27 V / 13.5 H	\$25.45	\$20.45
* Pizzazz/Pinwheel DS (On Greenway PFP)	54 "	55% Recycled Polyester - 45% FR Polyester	None	\$25.45	\$20.45
Scope	72 "	100% Inherent Polyester FR	7.35 V / 7 H (RR)	\$47.00	\$42.00

Alphabetical Listing Index

Pattern	Page	Pattern	Page	Pattern	Page	Pattern	Page	Pattern	Page	Pattern	Page
Absolute-C	30	Chase-C/U	46	Duchess-C	31	Famous-C	52	Flag-C	53	Gaiety-C	27
Accolade-C	30	Chenille Rib-C	52	Dusk-C	31	Fanciful-C	32	Flambe-C	53	Galahad-C	34
Acoustic-C	30	Cheryl	30	Earthy-C	27	Fancy-C	52	Flamboyant-C	53	Gamma	28
Alden	30	Chummy-C	46		31	Fanfare-C	32	Flamenco	53	Garden	34
Alistair-C	46	Cinema - C	8	Eastwood-C	9	Fanning-C	32	Flanders-C	33		9
Allegory-C	30	Cinzia-C	8	Eccentric-C	27	Fantasia-C	32	Flapjacks-C	53		21
Anchor-C	8	Clara-C	8		31	Fantastic-C	52	Flare-C	33	Gauntlet	9
	26	Classy-C	46	Eclipse-C	38	Fantasy-C	32	Flash-C	53		21
Animal-C	52	Clovis-C	46	Ecliptic/Embellish	39	Fantine-C	32	Flashy-C	33	Gearbox-C	46
Animal-C/U	46	Coco-C	8	Ecliptic-C	27	Fargas-C	32	Flat Top-C	33		49
Arista-C	30	Cody-C	46		31	Fargo-C	52	Flavor-C	53	Genesis-C	28
Aristocrat-C	30	Cole-C	9	Ecology-C	27	Faris-C	32	Flesh-C	33		34
Aristotle-C	30	Comfy-C	9		31	Farmer-C	32	Flex-C	33	Gentry-C	28
Artisanal-C	30	Compass-C	30	Edison-C	9	Farrak-C	32	Flicker-C	53		34
Artisanal-C/U	8	Compass-C/U	9	Edward-C	46	Farr-C	32	Flight-C	53	Geode	28
Aurora-C	30	Connoisseur-C	30	Effervesce/Elixir D	39	Farrow-C	32	Fling-C	53		9
Avalon-C	30	Conrad-C	46	Effervesce-C	27	Farthing-C	32	Flip-C	53		21
Avery-C	30	Consort-C	52		31	Fascination-C	52	Flirt-C	53	Giggle-C	28
Bach-C	30	Cookie-C	46	Einstein-C	9	Fashion-C	52	Float-C	33		28
Bagatelle	8	Cosima-C	9	El Yunque-C	31	Fathom-C	32	Flora-C	33	Glance-C	34
	21	Cozumel-C	9	El Yunque-C/U	9	Favor-C	53	Flourish-C	53		28
Bahia	30		26	Electron/Elixir DS	39	Favorite-C	53	Flown-C	33	Glimmer-C	34
Bali	30	Cozy-C	9	Electron-C	27	Favre-C	32	Fluid-C	33		28
Bangkok-C	30	Crest-C	9		31	Fawn-C	32	Flurry-C	34	Glorious-C	35
Barrier Reef-C	8		26	Element-C	27	Faye-C	32	Flute-C	34		28
	26	Cubby-C	46		31	Fazio-C	32	Fly-C	53	Google	35
Bath	52	Cuddly-C	9	Elite-C	9	Feast-C	32	Folio-C	53		9
Bauble-C	30	Culture-C	52	Elixir-C	27	Feather-C	32	Folk-C	53		21
Bauble-C/U	8	Curly-C	46		31	Fedora-C	53	Folly-C	34	Gracious	9
Beach Club-C	8	Curves-C	52	Elizabeth	31	Feldon-C	32	Fonda-C	34		21
	26	Cutesy-C	46	Eloquent-C	27	Felice-C	32	Fool-C	34	Grandeur-C	28
Beachcomber	8	Damascus-C	51		31	Felicity-C	53	Foolish-C	34		35
	21		52	Embellish-C	27	Feline-C	32	Foray-C	34	Green Heart	46
Bedding Encasem	43	Dappled-C	51		31	Feliz-C	32	Forces-C	34		49
Beethoven-C	30		52	Eminence-C	27	Feller-C	32	Ford-C	34	Green Tea	9
Bellaire	8	Darius-C	30		31	Fellini-C	53	Forecast-C	34		21
	21	Darkness-C	30	Emperor-C	27	Fellow-C	32	Forever-C	53	Greenlight	9
Belmar-C	30	Daybreak-C	51		31	Femme Fatale-C	53	Forge-C	53		21
Biltmore-C	30		52	Empire-C	9	Femme Fatale-C/U	46	Formal-C	53	Gridlock	46
Biltmore-C/U	8	Dazzle-C	31	Enchanted-C	27	Ferdinand-C	53	Forsetta-C	34		49
Birmingham	30	Decimal-C	51		31	Fergie-C	32	Forster-C	53	Grindstone	46
Bliss	30		52	Equinox-C	9	Feronia-C	33	Fortune-C	34		49
	39	Decoupage-C	51	Erik-C	46	Ferraro-C	33	Forum-C	34	Groovy	9
Blossom-C	30		52	Escape-C	9	Ferrer-C	33	Fossil-C	34		21
Blossom-C/U	8	Deep-C	31		26	Ferris-C	33	Foulard-C	53	Guru-C	28
Bodhi Leaves	8	Delight-C	51	Estate-C	9	Ferry-C	33	Fox-C	34		35
	21		52	Eureka-C	31	Festive-C	53	Foxglove-C	34	Halifax-C	35
Bonanza	8	Delphi-C	31	Eureka-C/U	9	Festoon-C	33	Foxy-C	34	Hamilton-C	28
	21	Dense-C	31	Extinct-C	31	Fez-C	33	Fraction-C	34		35
Botany	8	Dervish-C	31	Extinct-C/U	9	Fiction-C	33	Fragrance-C	53	Harrison-C	35
	21	Destiny-C	51	Fable-C	52	Fiddle-C	33	Fragrant-C	34	Havana-C	28
Brahms-C	30		52	Fabray-C	31	Fidela-C	33	Frail-C	53		35
Bullseye-C	52	Devon-C	31	Fabulous-C	52	Fidelity-C	33	Franc-C	34	Haven	35
Bullseye-C/U	46	Diana	31	Façade-C	31	Fiery-C	33	Franco-C	53		39
Cache-C	8	Dimension-C	51	Factor-C	31	Fiesta-C	33	Frappe-C	54	Helix-C	35
Cancun-C	52		52	Fad-C	31	Fig-C	33	Frat-C	54	Henry-C	47
Canopy	30	Dimmer	31	Fair-C	32	Figgins-C	33	Frazzle-C	34	Hickory-C	35
	39	Distinctive/Decim	51	Fairchild-C	52	Fiji-C	33	Free-C	54	Highland	35
Capricia-C	46	Distinctive-C	51	Fairfax-C	52	Finch-C	53	Freedom-C	34	Honesty-C	35
Carlina-C	8		52	Fairlee-C	32	Fine-C	33	Freeze-C	54	Horizons-C	9
Carnival Net 3	39	Divine-C	31	Faison-C	32	Finery-C	33	Freon-C	34		26
Carnival Net 3 - W	39	Dock-C	9	Faith-C	52	Finicky-C	33	Fresh-C	54	Houston-C	35
Caterina-C	8		26	Faizah-C	32	Finite-C	33	Freud-C	34	Hunter-C	54
Celebrate -C	8	Dominant-C	51	Falana-C	32	Finn-C	33	Frey-C	54	Hunter-C/U	47
Celia-C	8		52	Falcon-C	52	Fiona-C	33	Friedan-C	34	Huntington-C	35
Chain Link-C	52	Domino-C	31	Falk-C	32	Firebird-C	53	Friend-C	34	Hyde Park-C	35
Chain LinkC/U	46	Doodle-C	51	Falkner-C	52	Firefly-C	33	Frills-C	34		39
Chancery-C	30		52	Fallen-C	32	Fisher-C	53	Fronde-C	34	Ideal	35
Chancery-C/U	8	Dream-C	31	Falls-C	32	Fishery-C	33	Fun-C	34		39
Charles-C	46	Drummer-C	51	Fame-C	52	Fizz-C	33	Gaelic	9		41
Chase-C	52		52	Family-C	32	Fizzle-C	33		21	Illustrious-C	35

Pattern	Page	Pattern	Page	Pattern	Page	Pattern	Page	Pattern	Page	Pattern	Page
Illustrious-C/U	10	Nouveau-C	11	Ramapo-C	54	Seurat-C/U	12	Ultra	36	Vanity	14
Inland	35	Novella-C	11	Ravi-C	54	Shadowbox	12		39		17
	39	Nuclear-C	11	Ray-C	11		22		41		23
	41	Oleg-C	47		26	Shepherd	12	Ulysses	36	Vantage-C	14
Island Breeze-C	10	Outlaw-C	54	Redding	11		22		39		17
	26	Outlaw-C/U	47		21	Shore-C	47		41		23
Jackpot-C	10	Pace	47	Reggio/Reggio DS	39		50	Umbria	36		26
Jail Bird-C	54		49	Reggio-C	54	Shoreline-C	12		39	Varney	47
Jail Bird-C/U	47	Paddock	47	Relax-C	11		26		41		48
Jamboree-C	10		49		26	Siam-C	36	Universe-C	36		49
Jazz-C	10	Pageant	47	Renegade-C	54		39	Utopia	36	Varsity	14
Jersey-C	10		49	Renegade-C/U	47	Sidebar	12		40		17
Jitterbug-C	10	Palace	47	Reno	11		22		41		23
Jolie-C	10		49		21	Silvia	12	Vabyn	47	Vassal	14
Journey-C	10	Palatial-C	36	Reston	11		22		48		17
Jovial-C	10	Palatial-C/U	11	Revere-C	54	Simona	12		49		23
Kate	35	Palatine	47	Rhinebeck	12		22	Vacation-C	13	Vayard	47
Kindness	54		49		21	Skipper-C	12		17		48
Lansing-C	10	Panache-C	51	Richmond	12		26		22		49
Laurel-C	10		54		21	Skywalk	12		26	Vector	14
Le Cirque-C	35	Pandora/Panache	57	Rio-C	36		22	Vaggio	13		17
Lebois	38	Parade	11		39	Slattery	12		17		23
Leland-C	10		21	Riverside	12		22		22	Velocity	14
Lenox-C	10	Paradise/Paragon	57		21	Sofia	12	Valencia	13		17
Liason	56	Paradise-C	51	Rochester	12		22		17		23
Liason - Ivory	56		54		21	Soho-C	36		22	Venture	14
Liason - White	56	Paragon-C	51	Rockefeller-C	36	Soho-C/U	12	Valentine	13		17
Lictor	38		54	Rockville	12	Soloist	12		17		23
Light Control	38	Parallel	11		21		22		22	Venue	14
Lights Out	38		21	Rogue-C	54	Sonia	13	Valet	13		17
Liteless - Natural	35	Paris	47	Rogue-C/U	47		22		17		23
Lockport-C	10		49	Roxbury	12	Sonic	13		23	Verbana	14
Lowell-C	10	Parson-C	51		21		22	Valiant	13		17
Loxley-C	10		54	Rudolph-C	47	Sophora	13		17		23
Madison Avenue-	35	Pasha-C	51	Rumson	36		22		23	Verdi	14
Maguire	35		54	Rupert-C	54	Soprano	55	Valid	13		17
Maguire U-C	10	Paterson-C	51	Russell-C	54	Sparkle	13		17		23
Manchester	35		54	Rye-C	54		22		23	Verdict	14
Maritsa	35	Patio	11	Sachett Swirl-C	54	Springwood	13	Valise-C	13		18
	39		21	Sachett-C	54		22		17		23
Markham	35	Patriot-C	51	Saga-C	54	Starry Nite-C	13		23	Verity	14
	39		54	Salerno	12		26		26		18
Marquette	35	Piccolo-C	51		22	Stefania	13	Valley	14		23
	39		54	Salient-C	55		22		17	Veronica	36
Maze-C	35	Pillar-C	51	Salute	12	Steward	13		23	Verse	14
Maze-C/U	10		54		22		22	Valone	14		18
Meridian	35	Pinwheel-C	54	Samantha	12	Sublime-C	36		17		23
	39	Pioneer	11		22	Sublime-C/U	13		23	Vevel	14
Merry-C	35		21	Sambuca	47	Sumptuous	36	Valor	14		18
Merry-C/U	10	Pique-C	36		49	Sunny Days-C	13		17		23
Metro	35		41	Sanborn	12		26		23	Vex	14
	39	Pirouette-C	51	Sand Box-C	55	Susana	13	Value	14		18
Ming	36		54	Sandbar-C	12		22		17		24
	39	Pizzazz/Pinwheel	57		26	Sweetbriar Str.-C	55		23	Vexing	14
Mirage	36	Pizzazz-C	54	Sapling-C	55	Sweetbriar-C	55	Vancouver	14		18
	39	Poetic	11	Sargeant Stripe-C/	12	Target-C	55		17		24
Mondrian	36		21	Savina	12	Target-C/U	47		23	Vibe	14
	39	Poolside-C	11		22	Tetris-C	13	Vanderbilt	47		18
Montana	39		26	Savvy	12	Text	36		48		24
Narcissist-C	36	Portico	11		22	Thistle-C	13		49	Vibrant	14
Natalie	36		21	Schooner-C	12	Tiffany-C	36	Vane	14		18
Nature-C	10	Precision-C	36		26	Tino	36		17		24
Network-C	10	Precision-C/U	11	Scope	55	Titan-C	13		23	Viceroy-C	15
Nexus-C	36	Providence	36		57	Toledo-C	13	Vanguard	14		18
Nifty-C	11	Pueblo	11	Sensuous-C	12	Tradition	55		17		24
Nirvana-C	36		21	Sentino	12	Tradition Str.	55		23	Victory	15
Nitesuede Fr 2p	38	Puka Shells-C	11		22	Trafalgar Square-	36	Vanicia	14		18
Nitesuede Fr 3p	38		26	Sentry	12		39		17		24
Nitro-C	11	Purity	11		22	Treasure- C	13		23	Video	15
Nobility-C	11		21	Serafina	12	Trianon-C	36	Vanish	14		18
Nocturne-C	11	Quantum-C	54		22	Trianon-C/U	13		17		24
Nonpareil-C	36	Racine-C	54	Serene	12	Tumult-C	55		23	Vienna	15
Northern-C	11	Raleigh	47		22	Tundra-C	55				18
Notable-C	11		49	Seurat-C	36						24



Designed to Perform

102 Madison Avenue

New York, NY 10016

Phone: 212-686-6056

Toll Free: 800-621-5250

Fax: 212-686-6014

website: www.coralfabrics.com

e-mail: info@coralfabrics.com

READY SHIP
DRAPERY HARDWARE COLLECTION
PRICE LIST

JUNE 2015

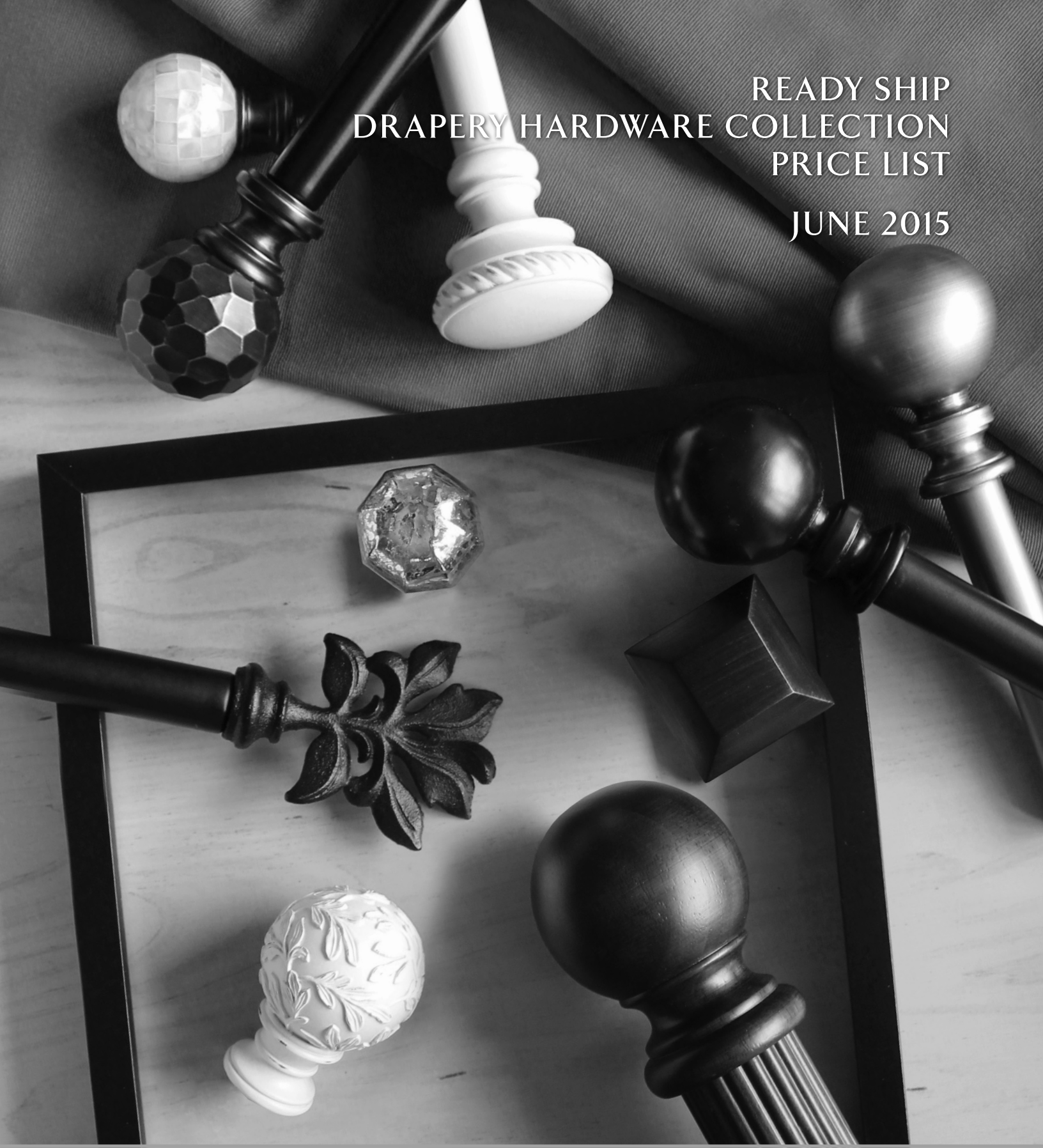

GRABER®

GENERAL INFORMATION

RECOMMENDED ROD PLACEMENT

We recommend mounting your drapery pole 6 1/2" to 7" above the glass. Allow at least 3" on each side of the window for you to be able to open draperies completely.

HOW TO ORDER

For wood order by part number and finish (XX).

For example:

3-706-01 = 1 3/8" Ball Finial with White Finish

3-700-14 = 1 3/8" Smooth 4' Pole with Caramel Finish

Complete listing of wood part numbers shown in brochure. All wood finials, rods, brackets and accessories sold separately.

For metal order by part number. Rod sets not available in multiple finishes. The rods are sold as sets that include a telescoping rod, finials, brackets and mounting hardware.

DELIVERY & RUSH ORDERS



All items will be shipped within 1 week following receipt of order.

RECEIPT OF GOODS

Do not accept any damaged boxes from Carrier.

Inspect all products upon receipt or damage claims may be denied.

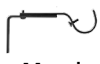
MEASUREMENTS

BRACKETS						
	1 3/8"	1 3/8" Extended	2"	2" Extended	 Metal Collection	 Outdoor Collection
A	3 13/16"	3 13/16"	3 7/8"	3 7/8"	2"	2 5/8"
B	5 3/8"	7 5/8"	6 1/8"	9"	Adjusts from 4" - 6"	4 1/2"
C	3 5/8"	6"	4 1/8"	7"	Adjusts from 3 1/2" - 5 1/2"	4"
D	1 1/8"	1 1/16"	1 1/4"	1 3/16"	7/8"	NA
Width	7/8"	7/8"	1 1/16"	1 1/16"	3/4"	1"

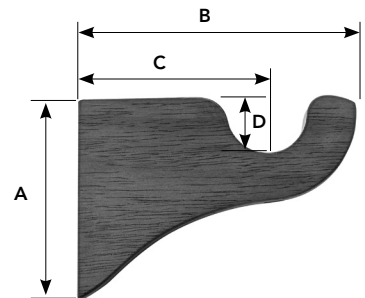



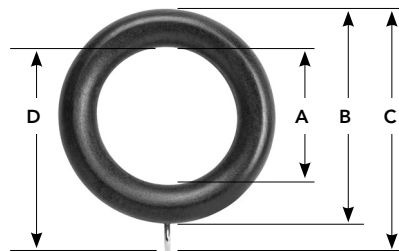











RINGS			
	1 3/8" Wood	2" Wood	1 1/2" Metal
A	1 7/8"	2 1/4"	1 1/2"
B	2 13/16"	3 5/8"	1 7/8"
C	3 3/16"	4 3/16"	2 1/4"
D	2 5/8"	3 3/8"	2"



READY SHIP DRAPERY HARDWARE COLLECTION

1 3/8" WOOD FINIALS, POLES AND ACCESSORIES

ITEM #	DESCRIPTION	IMAGE	DIMENSIONS* W x H x D	UNIT OF MEASURE	MANUFACTURER'S LIST PRICE
3-706-xx	Ball Finial fits 1-3/8" Pole		3.54" X 2.6" X 2.6"	Pair	\$34.00
3-707-xx	Square Finial fits 1-3/8" Pole		3.15" X 2.68" X 2.68"	Pair	\$47.00
3-708-xx	Urn Finial fits 1-3/8" Pole		3.74" X 2.48" X 2.48"	Pair	\$47.00
3-709-xx	Ovation Finial fits 1-3/8" Pole		4" X 2.68" X 2.68"	Pair	\$47.00
3-710-xxx	Fluted Finial fits 1-3/8" Pole		3.94" X 2.36" X 2.36"	Pair	\$47.00
3-711-xxx	End Cap Finial fits 1-3/8" Pole		1.06" X 2.13" X 2.13"	Pair	\$28.00
3-700-xx	Smooth Pole		4'	EA	\$57.00
3-701-xx			6'		\$77.00
3-702-xx			8'		\$97.00
3-703-xx	Fluted Pole		4'	EA	\$57.00
3-704-xx			6'		\$77.00
3-705-xx			8'		\$97.00
3-735-xx	Bracket		3" Clearance	EA	\$24.00
3-736-xx			6" Clearance		\$32.00
3-714-xx	Holdback		4.37" X 3.86" X 3.86"	Pair	\$58.00
3-712-xx	Inside Bracket Set		1.1" X 2.36" X 2.36"	Pair	\$20.00
3-713-xx	Swivel Elbow		3.68" X 1.89" X 1.89"	EA	\$44.00
3-717-xx	Wood Ring		0.5" X 2.87" X 2.87"	Set of 7	\$24.00
3-790-0	1-3/8" Wood Pole Connector		-	Box of 20	\$8.00

WOOD FINISH SELECTION





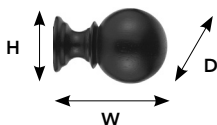



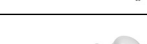
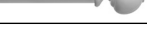

16 Antique Cherry 19 Espresso
 14 Caramel 01 White
 15 Chocolate

* WIDTH, HEIGHT AND DEPTH CALCULATED AS FOLLOWS:

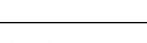

READY SHIP DRAPERY HARDWARE COLLECTION

2" WOOD FINIALS, POLES AND ACCESSORIES

ITEM #	DESCRIPTION	IMAGE	DIMENSIONS* W x H x D	UNIT OF MEASURE	MANUFACTURER'S LIST PRICE
3-724-xx	Ball Finial fits 2" Pole		4.57" X 3.35" X 3.35"	Pair	\$80.00 \$76.00 (00)
3-725-xx (not available in 00)	Square Finial fits 2" Pole		4.13" X 3.43" X 3.43"	Pair	\$100.00
3-726-xx (not available in 00)	Urn Finial fits 2" Pole		4.76" X 3.23" X 3.23"	Pair	\$100.00
3-727-xx (not available in 00)	Ovation Finial fits 2" Pole		4.72" X 3.39" X 3.39"	Pair	\$100.00
3-728-xx (not available in 00)	Fluted Finial fits 2" Pole		5.08" X 2.99" X 2.99"	Pair	\$100.00
3-729-xx	End Cap Finial fits 2" Pole		1.42" X 2.87" X 2.87"	Pair	\$40.00 \$36.00 (00)
3-718-xx	Smooth Pole		6'	EA	\$154.00/\$144.00 (00)
3-719-xx			8'		\$194.00/\$182.00 (00)
3-721-xx	Fluted Pole (not available in 00)		6'	EA	\$154.00
3-722-xx			8'		\$194.00
3-737-xx	Bracket		3" Clearance	EA	\$30.00/\$26.00 (00)
3-738-xx			6" Clearance		\$34.00/\$32.00(00)
3-714-xx	Holdback		4.37" X 3.86" X 3.86"	Pair	\$58.00 \$44.00 (00)
3-730-xx	Inside Bracket Set		1.69" X 3.35" X 3.35"	Pair	\$40.00 \$36.00 (00)
3-731-xx	Swivel Elbow		4.87" X 2.5" X 2.5"	EA	\$58.00 \$54.00 (00)
3-734-xx	Wood Ring		0.71" X 3.7" X 3.7"	Set of 7	\$54.00 \$50.00 (00)
3-791-0	2" Wood Pole Connector		–	Box of 20	\$12.00

WOOD FINISH SELECTION





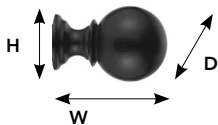







16 Antique Cherry 19 Espresso
 14 Caramel 00 Unfinished
 15 Chocolate 01 White

* WIDTH, HEIGHT AND DEPTH CALCULATED AS FOLLOWS:







READY SHIP DRAPERY HARDWARE COLLECTION

1" METAL DECORATIVE ROD SETS AND HOLDBACKS

ITEM #	DESCRIPTION	IMAGE	ITEM	UNIT OF MEASURE	MANUFACTURER'S LIST PRICE
2-100-58	Mercury Glass Rod Set		36-66"	EA	\$115.00
2-101-58			66-120"	EA	\$135.00
2-102-58			Holdback	Pair	\$45.00
2-103-94	Pewter Sphere Rod Set		36-66"	EA	\$100.00
2-104-94			66-120"	EA	\$118.00
2-105-94			Holdback	Pair	\$38.00
2-106-20	ORB Sphere Rod Set		36-66"	EA	\$100.00
2-107-20			66-120"	EA	\$118.00
2-108-20			Holdback	Pair	\$38.00
2-109-94	Pewter Cornet Rod Set		36-66"	EA	\$100.00
2-110-94			66-120"	EA	\$118.00
2-111-94			Holdback	Pair	\$38.00
2-112-20	ORB Cornet Rod Set		36-66"	EA	\$100.00
2-113-20			66-120"	EA	\$118.00
2-114-20			Holdback	Pair	\$38.00
2-115-39	Garde Rod Set		36-66"	EA	\$100.00
2-116-39			66-120"	EA	\$118.00
2-117-39			Holdback	Pair	\$38.00
2-118-07	Pearl Rod Set		36-66"	EA	\$100.00
2-119-07			66-120"	EA	\$118.00
2-120-07			Holdback	Pair	\$38.00
2-121-01	Vintage Rod Set		36-66"	EA	\$100.00
2-122-01			66-120"	EA	\$118.00
2-123-01			Holdback	Pair	\$38.00
2-124-20	ORB Lariat Rod Set		36-66"	EA	\$100.00
2-125-20			66-120"	EA	\$118.00
2-126-20			Holdback	Pair	\$38.00
2-127-61	Cream Lariat Rod Set		36-66"	EA	\$100.00
2-128-61			66-120"	EA	\$118.00
2-129-61			Holdback	Pair	\$38.00
2-142-94	Pewter End Cap Rod Set		36-66"	EA	\$83.00
2-143-94			66-120"	EA	\$97.00
2-144-94			Holdback	Pair	\$30.00
2-142-20	ORB End Cap Rod Set		36-66"	EA	\$83.00
2-143-20			66-120"	EA	\$97.00
2-144-20			Holdback	Pair	\$30.00

READY SHIP DRAPERY HARDWARE COLLECTION

1" METAL DECORATIVE ROD SETS, HOLDBACKS AND RINGS

ITEM #	DESCRIPTION	IMAGE	ITEM	UNIT OF MEASURE	MANUFACTURER'S LIST PRICE
2-130-39	Indoor/Outdoor Botanical Rod Set		36-66"	EA	\$110.00
2-131-39			66-120"	EA	\$130.00
2-132-39			Holdback	Pair	\$45.00
2-133-39	Indoor/Outdoor Arcadia Rod Set		36-66"	EA	\$110.00
2-134-39			66-120"	EA	\$130.00
2-135-39			Holdback	Pair	\$45.00
2-136-39	Indoor/Outdoor Song Bird Rod Set		36-66"	EA	\$110.00
2-137-39			66-120"	EA	\$130.00
2-138-39			Holdback	Pair	\$45.00
2-139-20	Indoor/Outdoor Elemental Rod Set		36-66"	EA	\$110.00
2-140-20			66-120"	EA	\$130.00
2-141-20			Holdback	Pair	\$45.00
2-145-39	1.5" Rings		Black	Package (7 pcs)	\$20
2-145-01			White		
2-145-94			Pewter		
2-145-61			Cream		
2-145-07			Antique Gold		
2-145-58			Satin Nickel		
2-145-20			Oil Rubbed Bronze		

WARRANTY

SPRINGS WINDOW FASHIONS ARTISAN DRAPERY HARDWARE WARRANTY

TYPE OF WARRANTY

Limited Lifetime on:

- All drapery hardware products using all drapery hardware components

WHAT IS COVERED

This product is warranted against original defects in materials or workmanship for as long as the original purchaser owns the product provided that:

1. the product was properly installed in a residential dwelling;
2. the product was made or assembled exclusively from Springs Window Fashions materials and components;
3. Springs Window Fashions recommendations were followed with regard to limitations and specifications.

WHO IS COVERED

This warranty extends only to you as the original purchaser of the above stated product.

OBLIGATIONS TO THE CONSUMER

The obligations of Springs Window Fashions are limited to the repair or replacement of parts or products found to be defective.

Springs Window Fashions is not responsible for shipping costs or labor costs, for measuring and taking the product down or for remeasuring or reinstalling the product.

If repairs are made under this warranty, the repairs will be made with like or similar parts.

WHAT THE WARRANTY DOES NOT COVER

This warranty does not cover conditions or damages caused by abuse, accidents, alterations, misuse or failure to follow instructions for measurement, installation, use, cleaning or maintenance. Normal wear and tear, including but not limited to the items or occurrences below, is not covered by the warranty.

- Some slight warpage, as well as natural variations in color and grain, are normal with a wood product and are not considered defects.
- Some loss of color intensity or discoloration may occur in wood finishes when exposed to direct sunlight over long periods of time.
- All cords will eventually wear out.

Springs Window Fashions considers these items and occurrences normal wear and tear and they are not covered by this warranty.

THIS WARRANTY IS EXCLUSIVE AND IN LIEU OF ALL OTHER WRITTEN OR ORAL WARRANTIES OR OBLIGATIONS AND LIABILITIES.

No person is authorized to extend or alter this warranty.

SPRINGS WINDOW FASHIONS SHALL HAVE NO LIABILITY WHATSOEVER FOR INCIDENTAL OR CONSEQUENTIAL DAMAGES.

Some states do not allow the exclusion or limitation of incidental or consequential damages, so this limitation or exclusion may not apply to you.

SERVICE

Warranty claims must be accompanied by the original sales receipt as well as details regarding the nature of the problem, location of the product, etc. To obtain warranty service contact:

Customer Service Center
Springs Window Fashions, LLC
8467 Route 405 Highway South
PO Box 500
Montgomery, PA 17752-0500

You may also email
dealerquestions@springswindowfashions.com
or call 1-800-221-6352



Graber is a brand of Springs Window Fashions, the Best Experience Company



graberblinds.com

Graber and the Graber logo are registered trademarks of Springs Window Fashions, LLC.

19-0633-00 (06/15) 150368S150090

HBF TEXTILES

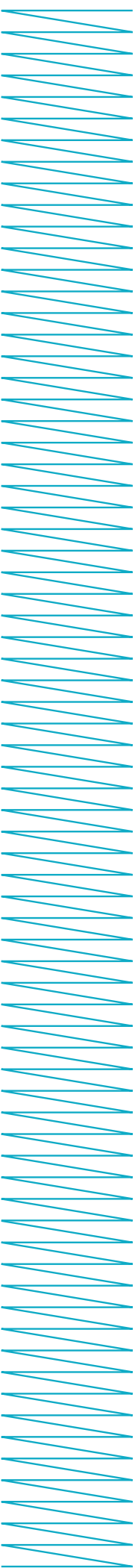

2016 Net Price List
Effective Date February 28, 2016

HBF TEXTILES

NET PRICE LIST
Effective February 28, 2016

Upholstery

Pattern Number	Pattern Name	Net Price	Grade
906	Abito	60.00	G
895	Afghan	73.00	H
130	Against the Grain	27.00	A
846	Andante Encore	55.00	F
945	Beetle	44.00	D
824	Belgian Meadow	60.00	G
892	Beveled Line	35.00	B
938	Big Floral	58.00	F
930	Big Floral Stripe	54.00	F
849	Boucle Check	55.00	F
914	Bow Tie	30.00	A
924	Braids & Bars	63.00	G
950	Brushed Canvas	51.00	E
921	Buckle	54.00	F
897	Bumpy	29.00	A
670	Burnished Cloth	38.00	C
940	Butterfly	38.00	C
922	Caterpillar	58.00	F
902	Chatterbox	51.00	E
912	City Lights	60.00	G
885	Clay Wall	61.00	G
948	Cloud	55.00	F
645	Coco	85.00	J
863	Cocoon	99.00	K
844	Colony	37.00	C
905	Comfort Zone	45.00	D
964	Complex	51.00	E
952	Cork Cloth	79.00	J
917	Cove	64.00	G
899	Crew Cut	31.00	B
884	Crossing the Line	45.00	D
946	Cutout	60.00	G
932	Deco Epingle	63.00	G
931	Dot Structure	59.00	F
969	Dreamy	67.00	G

All prices are NET per yard FOB Manufacturer.

HBF Textiles reserves the right to change prices, grades or current product/color offering without prior notice.

Taxes, shipping costs, delivery and storage charges are additional.

Guaranteed Freight Program:

This program offers the opportunity to provide a fixed freight cost at the time of order placement for cut-yardage. **Add 5% of total Net price of the order with a minimum charge of \$15 Net per shipment for domestic ground shipments.** Add 10% of total Net price of the order with a minimum charge of \$30 Net per shipment for Canadian ground shipments. A nominal processing and handling fee of \$15 Net will be applied to all orders requesting third party freight.

HBF TEXTILES

NET PRICE LIST
Effective February 28, 2016

Upholstery

Pattern Number	Pattern Name	Net Price	Grade
966	Eccentric	115.00	L
936	Embossed Woven	86.00	J
918	Equation	49.00	E
853	Faux Real*	47.00	E
962	Faux Real II	39.00	C
967	Flirt	85.00	J
891	Flywheel	56.00	F
928	Forge	55.00	F
926	Foundation	71.00	H
834	Four of a Kind	62.00	G
941	Fourfold	42.00	D
915	French Knot	84.00	J
865	Fusion	46.00	D
864	Glint	57.00	F
944	Gradient Block	68.00	H
958	Gravel	34.00	B
876	Grommet	46.00	D
828	Heartfelt	62.00	G
916	High Rise	38.00	C
904	Hipster	77.00	J
965	Honest	35.00	B
968	Honest Square	91.00	K
890	I-Beam	51.00	E
116	Intersect	41.00	D
894	Knitwork	119.00	L
866	Landscape	56.00	F
919	Linkage	62.00	G
887	Making Waves	72.00	H
955	Merci Boucle	59.00	F
898	Mirage	37.00	C
933	Modern Tweed	36.00	C
869	Moss	61.00	G
925	Moving Blanket	60.00	G
939	Needlepoint Grid	72.00	H

***Note: Limited inventory**

All prices are NET per yard FOB Manufacturer.

HBF Textiles reserves the right to change prices, grades or current product/color offering without prior notice.

Taxes, shipping costs, delivery and storage charges are additional.

Guaranteed Freight Program:

This program offers the opportunity to provide a fixed freight cost at the time of order placement for cut-yardage. **Add 5% of total Net price of the order with a minimum charge of \$15 Net per shipment for domestic ground shipments.** Add 10% of total Net price of the order with a minimum charge of \$30 Net per shipment for Canadian ground shipments. A nominal processing and handling fee of \$15 Net will be applied to all orders requesting third party freight.

HBF TEXTILES

NET PRICE LIST
Effective February 28, 2016

Upholstery

Pattern Number	Pattern Name	Net Price	Grade
648	Neither Hide Nor Hair	74.00	H
888	Off & On	36.00	C
957	Peak	38.00	C
860	Peas in a Pod	39.00	C
935	Pebbled	39.00	C
690	Pivot	50.00	E
929	Remember	51.00	E
934	Remember Houndstooth	51.00	E
889	Rib Stitch	29.00	A
903	Ribbon and Jute	83.00	J
843	Richmond	41.00	D
878	Rough Terrain	83.00	J
836	Royal Plush*	66.00	G
937	Sable Island	63.00	G
910	Satin Duet	90.00	K
971	Smart	74.00	H
901	Smooth	50.00	E
956	Soft Angles	57.00	F
826	Spanish Grove	38.00	C
678	Spun	39.00	C
959	Squiggle Stripe	39.00	C
896	Stencil	56.00	F
913	Straight & Narrow	40.00	C
830	Straight Forward	45.00	D
923	Sweater	88.00	J
942	Tickled Herring	55.00	F
927	Twist	52.00	E
900	Urban Pinstripe	52.00	E
908	Velvet Tie	146.00	M
943	Wabi Sabi	45.00	D
920	Woodblock	65.00	G

***Note: Limited inventory**

All prices are NET per yard FOB Manufacturer.

HBF Textiles reserves the right to change prices, grades or current product/color offering without prior notice.

Taxes, shipping costs, delivery and storage charges are additional.

Guaranteed Freight Program:

This program offers the opportunity to provide a fixed freight cost at the time of order placement for cut-yardage. **Add 5% of total Net price of the order with a minimum charge of \$15 Net per shipment for domestic ground shipments.** Add 10% of total Net price of the order with a minimum charge of \$30 Net per shipment for Canadian ground shipments. A nominal processing and handling fee of \$15 Net will be applied to all orders requesting third party freight.

HBF TEXTILES

NET PRICE LIST
Effective February 28, 2016

Wrapped panel | systems panel

Pattern Number	Pattern Name	Net Price	Width
130	Against the Grain	27.00 per yard	57" W
945	Beetle	44.00 per yard	56" W
892	Beveled Line	35.00 per yard	57" W
914	Bow Tie	30.00 per yard	54" W
897	Bumpy	29.00 per yard	54" W
670	Burnished Cloth	38.00 per yard	54" W
940	Butterfly	38.00 per yard	56" W
948	Cloud	55.00 per yard	54" W
645	Coco	85.00 per yard	56" W
952	Cork Cloth*	79.00 per yard	54" W
899	Crew Cut	31.00 per yard	54" W
884	Crossing the Line	45.00 per yard	54" W
918	Equation	49.00 per yard	54" W
891	Flywheel	56.00 per yard	54" W
941	Fourfold	42.00 per yard	54" W
865	Fusion	46.00 per yard	54" W
958	Gravel	34.00 per yard	57" W
116	Intersect	41.00 per yard	66" W
955	Merci Boucle	59.00 per yard	54" W
898	Mirage	37.00 per yard	54" W
888	Off & On	36.00 per yard	54" W
957	Peak	38.00 per yard	56" W
935	Pebbled	39.00 per yard	54" W
889	Rib Stitch	29.00 per yard	58" W
843	Richmond	41.00 per yard	54" W
937	Sable Island	63.00 per yard	54" W
901	Smooth	50.00 per yard	54" W
826	Spanish Grove	38.00 per yard	54" W
830	Straight Forward	45.00 per yard	58" W
943	Wabi Sabi	45.00 per yard	54" W

*Note: wallcovering application

HBF Textiles standard terms, and general information for upholstery products also apply to Vertical Materials.

Ordering Information: Please consult a professional workroom to determine any required overage allowances.

All prices are NET per yard FOB Manufacturer.

HBF Textiles reserves the right to change prices, grades or current product/color offering without prior notice.

Taxes, shipping costs, delivery and storage charges are additional.

Guaranteed Freight Program:

This program offers the opportunity to provide a fixed freight cost at the time of order placement for cut-yardage. **Add 5% of total Net price of the order with a minimum charge of \$15 Net per shipment for domestic ground shipments.** Add 10% of total Net price of the order with a minimum charge of \$30 Net per shipment for Canadian ground shipments. A nominal processing and handling fee of \$15 Net will be applied to all orders requesting third party freight.

HBF TEXTILES

NET PRICE LIST
Effective February 28, 2016

Coated Fabric

Pattern Number	Pattern Name	Net Price	Grade
645	Coco	85.00 per yard	J
936	Embossed Woven	86.00 per yard	J
853	Faux Real*	47.00 per yard	E
962	Faux Real II	39.00 per yard	C
648	Neither Hide Nor Hair	74.00 per yard	H
935	Pebbled	39.00 per yard	C
937	Sable Island	63.00 per yard	G
901	Smooth	50.00 per yard	E

*Note: Limited inventory

Drapery

Pattern Number	Pattern Name	Net Price	Width
969	Dreamy	67.00 per yard	54"
910	Satin Duet*	90.00 per yard	54"

*Note: Passes NFPA 701 for drapery application with an FR Treatment.

HBF Textiles standard terms, and general information for upholstery products also apply to Vertical Materials.

Ordering Information: Please consult a professional workroom to determine any required overage allowances.

All prices are NET per yard FOB Manufacturer.

HBF Textiles reserves the right to change prices, grades or current product/color offering without prior notice.

Taxes, shipping costs, delivery and storage charges are additional.

Guaranteed Freight Program:

This program offers the opportunity to provide a fixed freight cost at the time of order placement for cut-yardage. **Add 5% of total Net price of the order with a minimum charge of \$15 Net per shipment for domestic ground shipments.** Add 10% of total Net price of the order with a minimum charge of \$30 Net per shipment for Canadian ground shipments. A nominal processing and handling fee of \$15 Net will be applied to all orders requesting third party freight.

HBF TEXTILES

NET PRICE LIST
Effective February 28, 2016

Leather

Pattern Number	Pattern Name	Net Price	Grade
710	Attaché	13.00 per Sq. Ft.	Leather IV
712	Aviator	11.00 per Sq. Ft.	Leather II
705	Equestrian	13.00 per Sq. Ft.	Leather III
704	Free Way	11.00 per Sq. Ft.	Leather II
715	Pearl	13.00 per Sq. Ft.	Leather III
708	Upper Crust	15.00 per Sq. Ft.	Leather V
703	Vivace	9.00 per Sq. Ft.	Leather I
709	Vivace II	9.00 per Sq. Ft.	Leather I
713	Voyage	17.00 per Sq. Ft.	Leather V

All prices are NET per yard FOB Manufacturer.

HBF Textiles reserves the right to change prices, grades or current product/color offering without prior notice.

Taxes, shipping costs, delivery and storage charges are additional.

Guaranteed Freight Program:

This program offers the opportunity to provide a fixed freight cost at the time of order placement for cut-yardage. **Add 5% of total Net price of the order with a minimum charge of \$15 Net per shipment for domestic ground shipments.** Add 10% of total Net price of the order with a minimum charge of \$30 Net per shipment for Canadian ground shipments. A nominal processing and handling fee of \$15 Net will be applied to all orders requesting third party freight.

Ordering Information

To expedite order entry and to ensure proper service, mail, fax, or email all orders direct to orders@hbftextiles.com.
HBF Textiles, 900 12th Street Drive NW, Hickory, NC 28601, 828.485.2690 Fax.
All orders faxed and then mailed to HBF Textiles must be marked "Confirmation".
HBF Textiles will not be responsible for duplicate orders left unmarked.

All fabrics are sold in one-half (1/2) yard increments. There is a two (2) yard minimum per colorway per order.

All leathers are sold by the whole hide. There is a whole hide minimum per colorway per order. For additional half-hide requests, add a \$25.00 Net cutting fee. Due to the irregular size of hides exact square footage will fall within a tolerance of one-half hide.

Orders are subject to our acceptance with issuance of a formal order confirmation. Our order confirmation is final and binding. Any subsequent changes must be requested in writing and subject to our ability to incorporate the requested change.

Note: There will be a \$50.00 Net processing fee for orders that are requested to be processed and shipped the same day as received.

Terms of Payment

If credit has not been established, full payment, including shipping (see HBF Textiles Guaranteed Freight Program), must accompany the order. Credit may be established upon acceptance of satisfactory credit references. HBF Textiles also accepts MasterCard, Visa and American Express. When order is placed please provide account number, expiration date and name of card holder. Open account terms; NET 30 days, FOB Manufacturer. HBF Textiles may cancel or change credit terms or may request a pre-payment at anytime.

Reserves

HBF Textiles will reserve fabrics for up to ten (10) working days upon request and intent to order. The reserve will delete on the tenth (10th) day at which time the fabric will become available for sale. Only one five (5) working day re-reserve is allowed.

Cancellations

Orders may not be cancelled without the written consent of HBF Textiles. If fabric has not been cut, cancellations are subject to a 15% handling charge. No cancellations are accepted once the fabric has been cut.

Returns

No returns will be accepted without written authorization. Credit will not be issued unless the fabric is received on our premises within thirty (30) days from the date of the written return authorization. Authorized returns will be subject to a 25% restocking fee and must be returned in a usable condition. No returns will be accepted after merchandise has been cut. Special order merchandise is not subject to return.

Samples

HBF Textiles will be pleased to send upholstery, wrapped panel, coated fabric, drapery or leather memo samples upon request.

Because of natural variations in fibers, yarns, dyes, weaves and hides, samples may not match existing inventory. Dye lot samples will be sent upon request and receipt of order.

Special Finishes

As an accommodation to our customers, HBF Textiles can have special finishes and acrylic backing applied at an additional charge. Refer to Special Finishes section under Price Lists at www.hbftextiles.com.

Custom Fabrics

HBF Textiles has the resources to develop special colors in any of our standard patterns. HBF Textiles' designs can also be translated into other fiber combinations to accommodate pricing or special applications.

Upon receipt of order for custom fabrics a 50% deposit is required. Custom fabrics and/or special colors are sold by the full piece only (piece sizes vary according to mill). The customer is responsible for purchasing production overage (not to exceed 10% of the total yardage ordered).

On many discontinued items, yardage may still remain or a special order may be placed if piece minimum requirements are met.

Fabric Maintenance

HBF Textiles upholstery fabrics should occasionally be vacuumed to maintain their quality and appearance. For cleaning spots, consult a professional cleaning service. For cleaning of draperies, sheers and wallcovering, consult a professional cleaning service to obtain proper care and maintenance information.

Warranty

HBF Textiles' fabrics and goods are subject to continuing guarantees filed with the Federal Trade Commission under the Textile Fiber Products Identification Act and the Wool Products Labeling Act of 1939.

HBF Textiles may substitute fiber content and/or yarns at its discretion, and change sources and country of origin when it deems necessary without notification. HBF Textiles is not responsible for dye lot variations, reverse crocking, or discrepancies in widths of fabrics. HBF Textiles does not warrant, guarantee or represent an exact match to cuttings, memos or any samples.

HBF Textiles makes no implied warranties, including any warranty of merchantability or fitness for any particular purpose. Except as expressly provided in this warranty, HBF Textiles is not responsible for any damages, including, consequential, punitive or incidental damages.

Claims

All HBF Textiles are carefully inspected and securely packed prior to shipment from Hickory, NC. They are accepted as such by the carrier. Liability ceases as shipments are delivered to the transportation company. HBF Textiles is not responsible for damages incurred in transit or storage. Before accepting goods from the carrier, examine the shipment carefully. If there is any loss or visible damage to the containers, insist that a notation be made on the delivery slip. Claims for damage or loss must be filed immediately with the carrier. In case of concealed damage, you are protected if a claim is filed within five (5) days of delivery. Other claims against HBF Textiles for defects, errors or shortages must be filed with HBF Textiles in writing within ten (10) days of delivery. Failure to make such a claim shall constitute full acceptance of the yardage and waiver of all defects, errors or shortages. Cutting of the textiles will be deemed acceptance of the yardage and waiver of all defects, errors or shortages.

Kravet - Fabric, Trim, Wallcovering
US Retail Price List - August 2016

Pattern	Repeat	Width	Price	UOM	Grade	Pattern	Repeat	Width	Price	UOM	Grade		
10938	22	3/4"	54"	129.00	YARD	15	16922	2	1/2"	54"	89.00	YARD	12
10991			48"	17.00	YARD	6	16989		24"	48"	159.00	YARD	53
11820			54"	27.90	YARD	11	17032	20	3/4"	54"	59.80	YARD	12
11898			54"	99.80	YARD	16	17035			54"	79.80	YARD	17
11926			54"	39.80	YARD	6	17045	1	3/4"	54"	69.00	YARD	10
11962			54"	115.00	YARD	17	17106	41	1/2"	54"	145.00	YARD	
12164			48"	199.00	YARD		17116	21	1/2"	54"	79.80	YARD	9
12762			54"	133.00	YARD	35	17118	6	1/2"	54"	79.80	YARD	7
129320			54"	99.00	YARD	5	17127	27	1/4"	54"	97.00	YARD	22
129520	1	1/2"	54"	75.00	YARD	5	17143		6"	54"	117.00	YARD	19
129522	1	1/2"	54"	85.00	YARD	5	17160	14	1/4"	54"	49.90	YARD	12
129581			54"	67.00	YARD	5	17166			55"	99.80	YARD	17
129586			54"	73.00	YARD	5	17207			55"	59.00	YARD	12
129587			54"	119.00	YARD	5	17245	7	1/2"	54"	39.80	YARD	8
13060	13	1/2"	54"	99.80	YARD	18	17275	28	3/4"	54"	89.80	YARD	
13270			55"	149.00	YARD	26	17290	1	1/4"	54"	99.00	YARD	24
13291	6	1/2"	51"	177.00	YARD	31	17292			54"	85.00	YARD	16
13298			54"	199.00	YARD	29	17339		3"	54"	97.00	YARD	16
13367			53"	69.80	YARD	14	17348	3	1/2"	54"	65.00	YARD	6
13378			54"	59.00	YARD	7	17355	30	3/4"	54"	35.00	YARD	5
14358			54"	119.00	YARD	29	17376		5"	54"	139.00	YARD	21
14516	6	3/4"	54"	139.00	YARD	28	17387	1	3/4"	54"	119.00	YARD	30
14601	12	3/4"	54"	59.80	YARD	10	17396	13	3/4"	54"	89.80	YARD	12
14691		3"	54"	79.00	YARD	8	17440			54"	39.80	YARD	10
14692	19	1/4"	54"	97.00	YARD	9	17535	1	3/4"	54"	95.00	YARD	15
14714	25	1/4"	54"	99.00	YARD	13	17555			54"	85.00	YARD	9
14738			59"	45.00	YARD	13	17570	2	3/4"	54"	119.00	YARD	20
14743			54"	99.00	YARD	18	17599	6	1/4"	54"	69.80	YARD	13
15034		6"	54"	97.00	YARD	12	17609			54"	189.00	YARD	33
15140			54"	39.90	YARD	11	17651			54"	210.00	YARD	39
15141			48"	45.00	YARD	16	17745			54"	79.00	YARD	10
15249			54"	87.00	YARD	15	17752	4	1/4"	54"	157.00	YARD	27
15263		1/2"	54"	119.00	YARD	22	17761	4	1/2"	54"	129.00	YARD	21
15264			54"	179.00	YARD	30	17763	5	1/2"	54"	129.00	YARD	23
15554		27"	54"	79.80	YARD	16	17908		1"	54"	169.00	YARD	30
15731			54"	30.50	YARD	8	17932		3/4"	54"	99.00	YARD	16
15734			54"	139.00	YARD	20	18000			54"	99.80	YARD	15
15849	11	1/2"	54"	99.00	YARD	22	18110			54"	316.00	YARD	56
15941		3"	54"	79.00	YARD	17	18153			54"	51.90	YARD	12
16058			54"	137.00	YARD		18157	26	1/2"	54"	99.80	YARD	26
16089		9"	54"	149.00	YARD	18	18196			54"	197.00	YARD	46
16119	21	1/2"	54"	149.00	YARD	20	18202	19	1/2"	54"	157.00	YARD	49
16146	16	3/4"	54"	139.00	YARD	25	18241		27"	54"	79.80	YARD	14
16150	15	3/4"	54"	199.00	YARD	25	18255			54"	69.00	YARD	13
16181			54"	89.80	YARD	15	18258			54"	25.90	YARD	
16233			54"	65.00	YARD	15	18291			54"	89.80	YARD	14
16234			54"	69.00	YARD	13	18297		4"	54"	125.00	YARD	26
16235			54"	61.90	YARD	11	18305			54"	89.80	YARD	15
16236			54"	69.00	YARD	12	18324	2	3/4"	54"	179.00	YARD	28
16267			54"	137.00	YARD	19	18390	6	1/2"	54"	37.00	YARD	5
16313		22"	48"	99.80	YARD	31	18465	2	1/2"	54"	99.00	YARD	20
16350	1	3/4"	54"	34.90	YARD	5	18500		24"	54"	129.00	YARD	22
16506			54"	75.00	YARD	14	18527		1"	54"	36.00	YARD	8
16638		1/2"	54"	73.00	YARD	15	18536			49"	139.00	YARD	24
16648		1"	54"	129.00	YARD	22	18706	1	1/2"	54"	97.00	YARD	18
16680	6	3/4"	54"	79.80	YARD	16	18752	4	1/2"	54"	129.00	YARD	21
16788	16	1/2"	54"	95.00	YARD	26	18764		1"	54"	109.00	YARD	17
16797		9"	54"	99.00	YARD	18	18779		3"	54"	79.00	YARD	13
16839		1/2"	54"	39.90	YARD	7	18844			54"	119.00	YARD	12
16888	2	3/4"	54"	113.00	YARD	26	18860			54"	59.80	YARD	10
16897			54"	57.00	YARD	11	18866		7"	54"	89.00	YARD	18
16903		13"	54"	149.00	YARD	35	18904			54"	49.80	YARD	8
16912		17"	50"	119.00	YARD	27	18930			54"	95.00	YARD	17

Prices herein quoted are suggested retail. Prices are subject to change without notice.
All shipping and special processing charges are additional.

US Retail Price List - August 2016

Pattern	Repeat	Width	Price	UOM	Grade	Pattern	Repeat	Width	Price	UOM	Grade
18934		54"	79.80	YARD	13	20569	14"	54"	39.90	YARD	8
18941		54"	59.00	YARD	10	20570	13"	54"	17.90	YARD	
19020	1"	54"	129.00	YARD	22	20571		54"	11.90	YARD	
19021	4 1/2"	54"	129.00	YARD	22	20581	1 1/4"	54"	99.80	YARD	16
19081	8"	54"	129.00	YARD	15	20582	5 1/2"	54"	99.80	YARD	14
19102		55"	117.00	YARD	17	20606		54"	59.00	YARD	18
19125	1"	54"	137.00	YARD	21	20607	18"	48"	197.00	YARD	28
19234	18 3/4"	54"	79.00	YARD	12	20612		54"	179.00	YARD	33
19254	27"	54"	67.00	YARD	15	20613		54"	69.90	YARD	27
19371		54"	358.00	YARD	65	20629		54"	99.80	YARD	
19391	1 1/2"	59"	93.00	YARD	19	20655		54"	129.00	YARD	25
19409	24 1/4"	54"	197.00	YARD	29	20656		54"	99.00	YARD	20
19485	1 3/4"	54"	79.00	YARD	16	20658		54"	129.00	YARD	28
19495	10"	52"	129.00	YARD	23	20676	12 1/2"	54"	109.00	YARD	18
19502	23"	54"	169.00	YARD	30	20685	26"	54"	125.00	YARD	14
19516	1"	54"	59.80	YARD	13	20686		54"	256.00	YARD	38
19574		54"	396.00	YARD	56	20687		54"	328.00	YARD	41
19583	25 1/2"	54"	129.00	YARD	16	20690	16 3/4"	54"	97.00	YARD	13
19611	19 1/2"	54"	149.00	YARD	38	20721	2"	54"	157.00	YARD	27
19663	1 1/2"	54"	59.00	YARD	8	20763	4 1/4"	54"	109.00	YARD	24
19672	4"	54"	65.00	YARD	10	20789		54"	145.00	YARD	18
19719		54"	67.00	YARD	11	20794	25"	54"	65.00	YARD	
19721		54"	39.00	YARD	7	20843	6"	54"	49.80	YARD	
19765	1"	54"	89.80	YARD	16	20878	1 1/4"	54"	59.80	YARD	
19771	24"	1/2"	149.00	YARD	36	20900		54"	59.00	YARD	15
19778	1 1/2"	54"	69.80	YARD	13	20927		54"	33.90	YARD	6
19779	3 1/2"	54"	85.00	YARD	14	20944	2 1/2"	54"	43.00	YARD	11
19787	37 1/2"	54"	99.00	YARD	15	20982	14"	54"	159.00	YARD	16
19792	12 1/2"	53"	89.80	YARD	17	20992	15 1/4"	54"	117.00	YARD	20
19794	6 1/4"	54"	115.00	YARD	19	20995	4 1/4"	54"	95.00	YARD	17
19802		54"	49.80	YARD	10	21052	2 1/2"	54"	39.90	YARD	
19813	19 1/2"	52"	244.00	YARD	41	21054		54"	29.90	YARD	5
19842	21 1/2"	54"	199.00	YARD	29	21055		54"	35.00	YARD	5
19947	37"	54"	270.00	YARD	56	21081		54"	49.80	YARD	7
19966	13 1/2"	51"	175.00	YARD	27	21083		54"	69.80	YARD	14
20001	28"	54"	115.00	YARD	19	21089	1 1/2"	57"	97.00	YARD	13
20010		54"	73.00	YARD	14	21098		54"	89.80	YARD	17
20023	23 1/2"	49"	115.00	YARD	24	21105		57"	9.90	YARD	
20024	9"	49"	115.00	YARD	21	21106		57"	9.90	YARD	
20083	14 1/2"	54"	85.00	YARD	14	21115	3 1/2"	54"	99.80	YARD	23
20089		54"	109.00	YARD	20	21116	49 1/4"	54"	448.00	YARD	160
20102		54"	216.00	YARD	29	21118	25 3/4"	54"	39.90	YARD	7
20117		54"	216.00	YARD	36	21146		54"	44.90	YARD	10
20118		54"	197.00	YARD	32	21147	1/2"	54"	34.90	YARD	7
20137	13 1/2"	54"	195.00	YARD	43	21179	17 1/4"	60"	210.00	YARD	65
20206	2"	54"	129.00	YARD	25	21183	1/2"	54"	97.00	YARD	18
20244	13 1/2"	54"	129.00	YARD	26	21186	1 3/4"	54"	119.00	YARD	19
20258		54"	165.00	YARD	26	21187	1/2"	54"	117.00	YARD	20
20262	13 1/4"	54"	119.00	YARD	18	21191	1"	54"	139.00	YARD	17
20264		54"	89.00	YARD	15	21192	1"	54"	149.00	YARD	17
20266	1 1/4"	54"	79.00	YARD	9	21194	1 1/2"	54"	99.00	YARD	16
20325	2 1/4"	46"	137.00	YARD	30	21196		54"	115.00	YARD	10
20349	41 1/4"	47"	149.00	YARD	29	21204		54"	89.00	YARD	17
20404		54"	159.00	YARD	21	21207	1"	54"	115.00	YARD	19
20406	7 1/2"	54"	119.00	YARD	21	21220	2 1/4"	54"	75.00	YARD	14
20419		54"	47.00	YARD	10	21270	7 3/4"	54"	85.00	YARD	11
20427	1 1/2"	54"	149.00	YARD	25	21273	26"	54"	79.00	YARD	12
20434		54"	159.00	YARD	18	21298		57"	47.00	YARD	9
20467		56"	33.90	YARD	6	21343	24"	54"	79.00	YARD	13
20511	2"	54"	75.00	YARD	7	21391	3 1/2"	54"	139.00	YARD	25
20520	20"	54"	95.00	YARD	17	21396		54"	53.00	YARD	9
20526	3/4"	54"	69.80	YARD	12	21402	3 1/2"	55"	59.00	YARD	6
20535	26 1/4"	54"	79.00	YARD	17	21404		54"	127.00	YARD	20

Prices herein quoted are suggested retail. Prices are subject to change without notice. All shipping and special processing charges are additional.

US Retail Price List - August 2016

Pattern	Repeat	Width	Price	UOM	Grade	Pattern	Repeat	Width	Price	UOM	Grade
21431	8	1/2"	54"	139.00	YARD	16	22168	65"	99.80	YARD	
21446	2	3/4"	54"	85.00	YARD	21	22210	1"	54"	99.80	YARD 10
21462		1"	54"	39.90	YARD	6	22213		54"	85.00	YARD 9
21483	12	1/4"	54"	248.00	YARD	25	22232	21	1/2"	49"	169.00 YARD 22
21486	20	1/2"	54"	75.00	YARD	13	22249		54"	197.00	YARD 23
21497			60"	67.00	YARD		22269		55"	199.00	YARD 25
21558	1	1/2"	54"	99.00	YARD	17	22295	12"	48"	216.00	YARD 41
21569	15	1/4"	50"	119.00	YARD	28	22304		47"	199.00	YARD 32
21593	2	3/4"	54"	59.80	YARD		22311	17"	55"	370.00	YARD 52
21608	14	1/2"	49"	169.00	YARD	28	22349		55"	199.00	YARD 23
21609	5	1/4"	54"	79.80	YARD	12	22351		55"	189.00	YARD 20
21629			54"	85.00	YARD	14	22363	8"	54"	49.90	YARD 11
21630	24	1/2"	54"	49.80	YARD	13	22373	7"	55"	195.00	YARD 26
21645		7"	54"	59.00	YARD	9	22406		48"	199.00	YARD 28
21647			54"	69.80	YARD	10	22408	20	1/4"	1/2"	199.00 YARD 49
21660	27	3/4"	54"	119.00	YARD	32	22416		54"	49.80	YARD 10
21666	23	1/4"	50"	129.00	YARD	29	22472		55"	290.00	YARD 33
21678			60"	79.00	YARD		22475	3"	51"	199.00	YARD 34
21700	17	1/2"	54"	79.00	YARD		22477		55"	77.00	YARD 11
21709	24	1/4"	54"	149.00	YARD	20	22523	1	1/2"	53"	199.00 YARD 37
21771			54"	220.00	YARD		22525	1"	54"	55.00	YARD
21773			54"	244.00	YARD		22547		54"	69.80	YARD 11
21778			52"	199.00	YARD		22567	2	1/2"	54"	59.80 YARD
21780			60"	149.00	YARD		22580	7"	54"	69.80	YARD 15
21782			60"	149.00	YARD		22606	24	1/2"	49"	137.00 YARD 33
21784			60"	168.00	YARD		22617	6	1/2"	54"	89.80 YARD 11
21787			60"	169.00	YARD		22636	8"	54"	149.00	YARD 53
21802		3"	54"	149.00	YARD	23	22642	7"	55"	135.00	YARD 25
21832			54"	65.00	YARD	11	22643		55"	179.00	YARD 31
21871			53"	135.00	YARD	19	22644	1	1/2"	55"	89.80 YARD 32
21893		8"	54"	99.80	YARD	20	22654	2	3/4"	54"	99.00 YARD 13
21901	19	1/2"	54"	99.80	YARD	11	22655	13	1/2"	54"	119.00 YARD 16
21910		5"	54"	159.00	YARD	36	22668	25	1/2"	54"	75.00 YARD 13
21911			54"	99.80	YARD	13	22677		49"	179.00	YARD 31
21916		18"	58"	59.80	YARD	8	22698		9"	54"	99.00 YARD 17
21922		6"	58"	69.80	YARD	9	22723	27	1/2"	54"	119.00 YARD 20
21925		12"	58"	79.80	YARD	10	22724		54"	119.80	YARD 16
21939		2"	60"	109.00	YARD	26	22725		1"	54"	59.00 YARD 8
21951		14"	54"	89.00	YARD	13	22773		55"	109.00	YARD 17
21952		34"	59"	199.00	YARD		22776		55"	189.00	YARD 23
21955		21"	55"	59.00	YARD		22780	16	1/2"	54"	19.90 YARD
21956	10	1/2"	55"	59.00	YARD	9	22788	6	1/2"	54"	97.00 YARD
21958	11	1/2"	54"	99.00	YARD	13	22790	4"	54"	99.80	YARD 18
21960		19"	54"	99.00	YARD	16	22796		50"	119.00	YARD 18
21969			54"	145.00	YARD	26	22809	2"	54"	119.80	YARD
21971			46"	149.00	YARD	23	22811		54"	95.00	YARD 16
21972	8	1/2"	54"	195.00	YARD	35	22814	14	1/2"	54"	129.00 YARD 33
21978	24	1/2"	56"	129.00	YARD		22879		54"	236.00	YARD 29
21987		2"	57"	220.00	YARD	33	22895		54"	430.00	YARD 94
22014	2	3/4"	54"	195.00	YARD	24	22900	6	1/2"	54"	117.00 YARD 49
22017			54"	11.00	YARD		22905	1	1/2"	47"	185.00 YARD 26
22018			54"	13.00	YARD		22936	7"	54"	79.00	YARD 11
22022			54"	119.80	YARD	21	22950		56"	79.80	YARD 10
22029		19"	54"	197.00	YARD	25	22953	16"	51"	197.00	YARD 43
22030		25"	53"	197.00	YARD	29	22977	1"	54"	95.00	YARD 5
22047	16	1/2"	54"	115.00	YARD	18	22978	6"	54"	69.80	YARD 11
22074		21"	54"	119.00	YARD	12	22988		54"	79.80	YARD 5
22086			52"	284.00	YARD		22989	13"	54"	79.80	YARD 14
22127		27"	54"	89.80	YARD	20	22990		54"	55.00	YARD 26
22134			54"	135.00	YARD	18	23011	17	1/2"	54"	43.00 YARD 8
22135			54"	169.00	YARD	34	23017	3"	54"	53.00	YARD 11
22136			60"	99.00	YARD	25	23027	3"	51"	115.90	YARD 5
22161			47"	316.00	YARD	41	23034	2"	54"	75.00	YARD 14

Prices herein quoted are suggested retail. Prices are subject to change without notice. All shipping and special processing charges are additional.

US Retail Price List - August 2016

Pattern	Repeat	Width	Price	UOM	Grade	Pattern	Repeat	Width	Price	UOM	Grade	
23037	1	1/2"	54"	149.00	YARD	30 23653		55"	244.00	YARD	33	
23054	8	1/2"	54"	89.80	YARD	14 23654	1/2"	55"	248.00	YARD	35	
23064			55"	199.00	YARD	23 23660		54"	199.00	YARD	25	
23067		2"	54"	117.00	YARD	20 23665	5	1/2"	54"	159.00	YARD	23
23068		7"	54"	85.00	YARD	12 23666	15"	54"	179.00	YARD	33	
23071	18	1/2"	54"	197.00	YARD	26 23684		54"	99.80	YARD	21	
23088			54"	79.80	YARD	14 23731		54"	149.00	YARD	16	
23089	10	1/4"	51"	137.00	YARD	21 23734		54"	99.00	YARD	19	
23093		7"	55"	197.00	YARD	33 23738	1"	54"	149.00	YARD	20	
23116	1	1/2"	54"	189.00	YARD	26 23755		54"	59.00	YARD	9	
23117			54"	129.00	YARD	15 23759	1"	54"	169.00	YARD	24	
23118		5"	54"	129.00	YARD	20 23767		52"	264.00	YARD	37	
23142			55"	197.00	YARD	22 23785	13"	54"	115.00	YARD	16	
23147	19"		55"	298.00	YARD	48 23793	1	1/2"	54"	99.00	YARD	5
23150			54"	197.00	YARD	33 23796	6	1/2"	54"	85.00	YARD	11
23157			55"	264.00	YARD	28 23808		54"	59.80	YARD	10	
23162			55"	37.90	YARD	6 23814	13	1/2"	53"	199.00	YARD	23
23165			54"	189.00	YARD	23 23821	6	1/2"	54"	97.00	YARD	11
23175	7	1/2"	55"	189.00	YARD	20 23825	3"	54"	97.00	YARD	11	
23197		3"	50"	99.00	YARD	19 23831		54"	145.00	YARD	18	
23217	2	1/2"	54"	119.00	YARD	17 23846		54"	59.00	YARD	5	
23218	1	1/2"	54"	115.00	YARD	5 23855	8"	54"	316.00	YARD	69	
23221	1	1/2"	54"	139.00	YARD	22 23862	9"	54"	145.00	YARD	33	
23224	5	1/2"	54"	97.00	YARD	16 23863	9"	54"	115.00	YARD	25	
23230			54"	99.80	YARD	12 23865	1"	54"	145.00	YARD	30	
23248	13"		54"	115.00	YARD	18 23866		54"	119.00	YARD	25	
23276	22"		54"	149.00	YARD	23 23867	9"	54"	115.00	YARD	26	
23280			55"	169.00	YARD	16 23874	5"	52"	159.00	YARD	34	
23288	20"		55"	276.00	YARD	40 23890	16"	54"	189.00	YARD	29	
23298	15"		54"	135.00	YARD	28 23896	1"	54"	298.00	YARD	44	
23313	10"		55"	149.00	YARD	23 23903	17	1/2"	54"	41.00	YARD	8
23336			54"	59.80	YARD	12 23925	13"	54"	51.90	YARD	13	
23345	12"		48"	129.00	YARD	29 23932	1	1/2"	54"	43.50	YARD	11
23352			54"	119.80	YARD	19 23956		54"	39.90	YARD	5	
23353	10"		54"	85.00	YARD	13 23960		54"	49.90	YARD	11	
23367	2"		54"	220.00	YARD	23990	1"	54"	169.00	YARD	22	
23378	20"		55"	59.00	YARD	10 23991	13	1/2"	55"	109.00	YARD	16
23407	1	1/2"	55"	117.00	YARD	15 24013	23	1/2"	54"	179.00	YARD	30
23408	3	1/2"	55"	139.00	YARD	16 24016		55"	99.80	YARD	12	
23417	18	1/2"	55"	59.80	YARD	15 24021	3	1/2"	54"	85.00	YARD	33
23421			57"	220.00	YARD	24 24029		54"	149.00	YARD	18	
23453			55"	159.00	YARD	17 24040	1"	54"	139.00	YARD	16	
23467	19	1/2"	54"	119.00	YARD	23 24043		54"	149.00	YARD	20	
23473			51"	376.00	YARD	49 24045		54"	169.00	YARD	21	
23477	1	3/4"	54"	99.80	YARD	19 24047	1	3/4"	54"	189.00	YARD	22
23478	4	1/2"	54"	119.00	YARD	21 24048	21"	54"	199.00	YARD	28	
23484	1"		54"	97.00	YARD	17 24049	25	1/2"	53"	199.00	YARD	42
23485			54"	264.00	YARD	34 24053		54"	69.80	YARD	10	
23529		7"	55"	129.00	YARD	18 24056	2	3/4"	54"	79.80	YARD	9
23559	4	1/2"	55"	199.00	YARD	28 24058	1"	54"	67.00	YARD	10	
23567			54"	135.00	YARD	18 24063		54"	47.00	YARD	10	
23575			54"	149.00	YARD	20 24065	13"	50"	169.00	YARD	26	
23577	2"		49"	109.00	YARD	24066	23"	54"	179.00	YARD	23	
23578	3"		49"	175.00	YARD	32 24067	4"	54"	179.00	YARD	21	
23604	10"		55"	236.00	YARD	28 24071	15	1/2"	55"	99.80	YARD	17
23623	1"		54"	99.00	YARD	24079	14"	54"	99.80	YARD	19	
23624			54"	69.80	YARD	16 24107	8	1/2"	54"	69.80	YARD	
23633	16"		54"	79.00	YARD	24108	4"	54"	149.00	YARD	20	
23634	7	1/2"	53"	145.00	YARD	25 24110	2	1/2"	55"	157.00	YARD	19
23636	5"		53"	115.00	YARD	26 24114	14	1/2"	53"	79.80	YARD	25
23637	13"		54"	89.00	YARD	24121	25"	55"	199.00	YARD	32	
23638			54"	197.00	YARD	37 24143	26	1/2"	54"	149.00	YARD	22
23644			55"	197.00	YARD	23 24148	26	1/2"	55"	179.00	YARD	25

Prices herein quoted are suggested retail. Prices are subject to change without notice. All shipping and special processing charges are additional.

US Retail Price List - August 2016

Pattern	Repeat	Width	Price	UOM	Grade	Pattern	Repeat	Width	Price	UOM	Grade	
24152	20	1/2"	53"	220.00	YARD	39 24577		54"	99.80	YARD	17	
24153		3"	53"	236.00	YARD	32 24584		53"	69.80	YARD	20	
24154	2	1/2"	54"	197.00	YARD	22 24585		52"	159.00	YARD	26	
24157		21"	54"	197.00	YARD	26 24595		54"	199.00	YARD	31	
24158	8	1/2"	54"	149.00	YARD	21 24596		54"	270.00	YARD	33	
24161			53"	157.00	YARD	21 24600		54"	197.00	YARD	26	
24165		1"	55"	89.80	YARD	13 24603		1"	53"	139.00	YARD	32
24166	2	1/2"	55"	85.00	YARD	13 24605	7	1/2"	54"	159.00	YARD	28
24171	13	1/2"	54"	129.00	YARD	17 24606		1"	54"	149.00	YARD	26
24176	2	1/2"	54"	55.00	YARD	9 24608		54"	149.00	YARD	23	
24188	33	1/2"	54"	99.80	YARD	19 24609		3"	48"	145.00	YARD	30
24189		1"	54"	149.00	YARD	19 24614		6"	54"	129.00	YARD	32
24193		19"	55"	145.00	YARD	20 24617			54"	149.00	YARD	24
24194			55"	115.00	YARD	13 24618		15"	54"	189.00	YARD	25
24200			54"	129.00	YARD	5 24622	13	1/2"	54"	129.00	YARD	15
24213	2	1/2"	54"	99.80	YARD	24634		8"	48"	185.00	YARD	
24234		3"	54"	139.00	YARD	18 24635		2"	53"	117.00	YARD	29
24238			54"	99.00	YARD	15 24636		4"	52"	175.00	YARD	39
24244	7	3/4"	55"	79.00	YARD	8 24637	7	1/2"	50"	199.00	YARD	37
24246		11"	54"	109.00	YARD	19 24640	7	1/2"	53"	195.00	YARD	37
24247		20"	54"	179.00	YARD	30 24641	4	1/4"	54"	129.00	YARD	31
24255			55"	79.00	YARD	7 24650	2	1/2"	54"	135.00	YARD	30
24266	2	1/2"	54"	97.00	YARD	5 24652			53"	316.00	YARD	
24268		3"	54"	97.00	YARD	10 24665			54"	149.00	YARD	22
24269		3"	54"	97.00	YARD	5 24666			54"	137.00	YARD	28
24270	7	1/2"	48"	99.00	YARD	19 24672			54"	149.00	YARD	27
24298		2"	54"	95.00	YARD	13 24673		1"	54"	179.00	YARD	32
24322	8	1/2"	54"	179.00	YARD	21 24685			54"	119.00	YARD	24
24323	3	1/2"	54"	129.00	YARD	18 24688	2	1/2"	54"	139.00	YARD	22
24328		10"	55"	149.00	YARD	29 24689			54"	139.00	YARD	23
24329		24"	55"	236.00	YARD	32 24692			54"	99.00	YARD	22
24330	5	1/2"	54"	197.00	YARD	26 24695		7"	54"	175.00	YARD	32
24334		9"	55"	175.00	YARD	32 24699		9"	54"	99.80	YARD	23
24349			55"	69.00	YARD	11 24700			54"	115.00	YARD	24
24350	2	1/2"	55"	65.00	YARD	12 24702			54"	99.80	YARD	23
24354		24"	54"	264.00	YARD	40 24703		6"	54"	169.00	YARD	29
24355		20"	55"	236.00	YARD	54 24704		1"	54"	125.00	YARD	30
24357	10	1/2"	54"	270.00	YARD	46 24724		3"	57"	85.00	YARD	16
24361			54"	199.00	YARD	32 24731	6	1/2"	1/2"	59.00	YARD	12
24364			54"	197.00	YARD	35 24757		11"	53"	199.00	YARD	23
24365		2"	54"	149.00	YARD	35 24772		11"	54"	169.00	YARD	18
24371			54"	220.00	YARD	33 24781			55"	97.00	YARD	9
24394	10	5/8"	55"	99.80	YARD	16 24784	2	1/2"	54"	37.90	YARD	6
24396	3	1/2"	54"	177.00	YARD	24820	1	1/2"	54"	33.00	YARD	6
24402	11	1/4"	54"	139.00	YARD	59 24832	18	1/2"	55"	115.00	YARD	16
24409		1"	54"	129.00	YARD	42 24858			54"	195.00	YARD	32
24418	8	1/2"	54"	129.00	YARD	28 24880	7	1/2"	55"	117.00	YARD	15
24420			54"	199.00	YARD	24 24893		9"	54"	97.00	YARD	11
24460		14"	54"	264.00	YARD	45 24902		8"	55"	59.00	YARD	8
24470		3"	53"	117.00	YARD	31 24903			56"	236.00	YARD	26
24511			54"	199.00	YARD	27 24909			53"	99.80	YARD	17
24513		3"	54"	99.80	YARD	18 24911			54"	77.00	YARD	12
24517		7"	54"	199.00	YARD	45 24912			54"	69.80	YARD	10
24520		7"	54"	159.00	YARD	21 24913			54"	77.00	YARD	11
24534			54"	137.00	YARD	25 24914			54"	77.00	YARD	9
24540			54"	99.00	YARD	12 24916		14"	54"	179.00	YARD	35
24554	6	1/2"	54"	129.00	YARD	16 24918			54"	179.00	YARD	28
24557		12"	54"	99.00	YARD	13 24920			55"	298.00	YARD	38
24565			54"	179.00	YARD	28 24933		7"	50"	75.00	YARD	12
24567			54"	51.50	YARD	11 24937			55"	129.00	YARD	19
24570			55"	49.00	YARD	9 24940		7"	54"	99.00	YARD	5
24573			55"	41.90	YARD	14 24941	1	1/2"	54"	85.00	YARD	12
24575			54"	33.00	YARD	8 24961		1"	54"	159.00	YARD	23

Prices herein quoted are suggested retail. Prices are subject to change without notice. All shipping and special processing charges are additional.

US Retail Price List - August 2016

Pattern	Repeat	Width	Price	UOM	Grade	Pattern	Repeat	Width	Price	UOM	Grade
24966	4"	54"	97.00	YARD	5	25432	20"	56"	316.00	YARD	49
24980	5"	54"	99.00	YARD	12	25444		54"	39.80	YARD	
24985	12"	52"	95.00	YARD	23	25446	11"	54"	139.00	YARD	26
24993		54"	197.00	YARD	23	25458		54"	129.00	YARD	18
25005	15"	54"	159.00	YARD	23	25463		54"	316.00	YARD	
25007		53"	276.00	YARD	34	25467	16"	55"	336.00	YARD	50
25026		54"	99.80	YARD	13	25480		54"	199.00	YARD	32
25042	4 1/2"	54"	199.00	YARD	25	25502		55"	236.00	YARD	26
25048	28"	54"	79.00	YARD	15	25507	23 1/2"	55"	197.00	YARD	28
25057		54"	89.80	YARD	10	25532	30"	54"	250.00	YARD	46
25063		55"	199.00	YARD		25550		48"	157.00	YARD	27
25072		54"	49.00	YARD	11	25559		54"	197.00	YARD	30
25082	17"	54"	145.00	YARD	22	25569	1"	55"	570.00	YARD	99
25086		54"	65.00	YARD	16	25582	8"	48"	55.00	YARD	10
25099		54"	41.90	YARD	8	25596	10 1/4"	50"	159.00	YARD	23
25100		54"	51.90	YARD	11	25599	6"	60"	328.00	YARD	55
25113	13"	54"	42.50	YARD	10	25604		54"	199.00	YARD	27
25123	13"	54"	99.00	YARD	16	25605	8"	51"	135.00	YARD	22
25173		54"	45.90	YARD	10	25612		55"	35.00	YARD	7
25192	15 1/2"	54"	55.90	YARD	16	25613	4 1/2"	55"	45.00	YARD	5
25222	6"	58"	39.90	YARD	12	25614	28 1/4"	54"	336.00	YARD	70
25223		54"	41.90	YARD	9	25616	1 1/2"	55"	45.00	YARD	7
25228	12"	54"	39.90	YARD	7	25641	15"	56"	199.00	YARD	43
25234		54"	35.00	YARD	5	25649		54"	43.00	YARD	8
25250	13 1/2"	56"	49.80	YARD	9	25653	6"	55"	127.00	YARD	30
25251	13 1/2"	56"	55.00	YARD	6	25659		54"	85.00	YARD	11
25252		54"	59.00	YARD	5	25661		54"	99.00	YARD	5
25258	23 1/2"	55"	276.00	YARD	43	25662		55"	29.00	YARD	7
25301	19 1/2"	59"	336.00	YARD	53	25663		54"	97.00	YARD	11
25312	17"	55"	99.00	YARD	16	25668	2 1/2"	54"	97.00	YARD	13
25317	23"	55"	248.00	YARD	41	25670		54"	39.90	YARD	9
25329	13 1/2"	55"	420.00	YARD	91	25684		54"	119.00	YARD	21
25338	1 1/2"	54"	256.00	YARD	43	25687		54"	149.00	YARD	21
25342	21 1/2"	54"	59.00	YARD	8	25689		54"	195.00	YARD	24
25370	1"	55"	498.00	YARD	80	25691		54"	99.80	YARD	18
25371		55"	220.00	YARD	24	25692	19"	51"	169.00	YARD	29
25374		55"	169.00	YARD	18	25694	15 1/2"	55"	396.00	YARD	58
25375		55"	220.00	YARD	40	25700		54"	149.00	YARD	19
25376	1/2"	199.00	YARD	33	25703		54"	61.90	YARD	9	
25377		54"	199.00	YARD	25	25717		57"	45.90	YARD	5
25378		54"	199.00	YARD	26	25724	8 1/2"	61"	49.90	YARD	10
25379		55"	284.00	YARD	37	25738	7 1/2"	52"	149.00	YARD	23
25381	7"	55"	236.00	YARD	36	25739	2 1/2"	54"	99.80	YARD	13
25382		54"	139.00	YARD	18	25752		55"	199.00	YARD	18
25385		55"	256.00	YARD	30	25757	7"	54"	119.00	YARD	16
25387		55"	220.00	YARD	26	25760	28"	56"	199.00	YARD	
25388		55"	197.00	YARD	22	25762	7"	55"	199.00	YARD	31
25389		55"	248.00	YARD	25	25763		53"	149.00	YARD	27
25391		49"	159.00	YARD	25	25765		54"	139.00	YARD	22
25392		54"	248.00	YARD	28	25766		54"	119.00	YARD	16
25394		54"	169.00	YARD	22	25770		54"	97.00	YARD	13
25397		55"	220.00	YARD	39	25774	7"	54"	139.00	YARD	22
25398	2"	54"	159.00	YARD	19	25776		54"	137.00	YARD	16
25399		55"	149.00	YARD	21	25778	3"	54"	97.00	YARD	11
25400	13"	54"	159.00	YARD	22	25779	7 1/2"	54"	159.00	YARD	20
25402		54"	199.00	YARD	20	25780	9"	54"	95.00	YARD	12
25404		56"	197.00	YARD	28	25787	7"	55"	149.00	YARD	16
25406		54"	316.00	YARD	34	25789		54"	149.00	YARD	16
25408		55"	270.00	YARD	32	25793	7"	55"	109.00	YARD	18
25409		56"	197.00	YARD	23	25794		54"	89.80	YARD	15
25410		137"	220.00	YARD	31	25805		55"	129.00	YARD	14
25418		54"	390.00	YARD	50	25807		50"	149.00	YARD	23
25419		54"	199.00	YARD	20	25813		54"	119.00	YARD	24

Prices herein quoted are suggested retail. Prices are subject to change without notice. All shipping and special processing charges are additional.

US Retail Price List - August 2016

Pattern	Repeat	Width	Price	UOM	Grade	Pattern	Repeat	Width	Price	UOM	Grade
25815		54"	99.00	YARD	19	26119	13"	54"	99.80	YARD	13
25817		54"	69.00	YARD	12	26125	26"	54"	149.00	YARD	20
25818		54"	69.80	YARD	12	26126		55"	370.00	YARD	50
25820		54"	149.00	YARD	26	26127	2"	54"	99.80	YARD	5
25822		54"	99.80	YARD	19	26131		54"	496.00	YARD	71
25823		54"	99.80	YARD	21	26145		54"	99.00	YARD	17
25824		54"	149.00	YARD	27	26152		54"	276.00	YARD	41
25825		54"	75.00	YARD	13	26163	9"	54"	220.00	YARD	29
25827		54"	97.00	YARD	17	26165		54"	79.00	YARD	9
25828		54"	85.00	YARD	16	26166	4 1/2"	55"	179.00	YARD	
25829		54"	85.00	YARD	16	26174		54"	55.00	YARD	7
25830		54"	99.80	YARD	19	26199		55"	179.00	YARD	21
25831	1 1/2"	54"	159.00	YARD	40	26205		56"	89.90	YARD	5
25832		54"	75.00	YARD	14	26246		54"	38.90	YARD	13
25833		54"	65.00	YARD	15	26247		54"	51.50	YARD	17
25843	29"	54"	149.00	YARD	26	26255	10 1/2"	56"	45.00	YARD	12
25845	29"	54"	169.00	YARD	28	26265	28 1/2"	54"	125.00	YARD	15
25847		54"	199.00	YARD	26	26266	12 1/2"	54"	99.00	YARD	15
25857		54"	75.00	YARD	12	26267	8 1/2"	54"	69.80	YARD	10
25860	9"	54"	75.00	YARD	13	26270	1"	54"	59.00	YARD	
25869		54"	199.00	YARD	30	26271	13"	54"	129.00	YARD	20
25873	1 1/2"	54"	119.00	YARD	30	26282	14"	54"	42.50	YARD	10
25875	7"	54"	197.00	YARD	32	26289		54"	59.90	YARD	14
25877		1/2"	175.00	YARD	29	26290		54"	37.00	YARD	7
25878	7 1/2"	52"	159.00	YARD	32	26341	3 1/2"	54"	99.80	YARD	13
25880	25"	51"	197.00	YARD	42	26346	9 1/2"	55"	199.00	YARD	31
25881		54"	179.00	YARD	27	26358	8"	54"	129.00	YARD	18
25886	8 1/2"	49"	119.00	YARD	34	26359	1 1/2"	54"	97.00	YARD	5
25890	7 1/2"	54"	119.00	YARD	36	26368	9"	54"	34.90	YARD	
25892	2"	54"	199.00	YARD	31	26370	17 1/2"	1/2"	59.80	YARD	
25896		54"	169.00	YARD	25	26373	7"	54"	159.00	YARD	23
25897	26"	54"	115.00	YARD	115	26380	2"	54"	97.00	YARD	5
25898	7 1/2"	53"	185.00	YARD	44	26388		54"	59.00	YARD	12
25909	13"	54"	99.00	YARD	14	26395	3"	54"	95.00	YARD	18
25927	7 5/8"	53"	236.00	YARD	44	26404	2"	54"	129.00	YARD	20
25930		55"	159.00	YARD	26	26407	1"	54"	179.00	YARD	23
25937		55"	59.00	YARD	7	26410	3"	56"	49.80	YARD	6
25938		54"	49.80	YARD	6	26414		56"	75.00	YARD	9
25939	15"	54"	149.00	YARD	35	26421	13 1/2"	54"	129.00	YARD	22
25940	15"	54"	139.00	YARD	34	26439		54"	157.00	YARD	25
25951		55"	159.00	YARD	21	26461		54"	169.00	YARD	24
25975	2"	60"	29.90	YARD	8	26474		54"	159.00	YARD	31
25984	11 1/2"	55"	199.00	YARD	31	26475		54"	129.00	YARD	23
25986	13 1/2"	55"	39.90	YARD	5	26481		54"	44.90	YARD	10
25988	22 1/2"	54"	89.00	YARD	15	26499	26"	55"	296.00	YARD	37
26008	3 1/2"	55"	69.80	YARD	7	26519		54"	129.00	YARD	19
26019	14"	55"	149.00	YARD	17	26520	6 1/2"	55"	89.00	YARD	20
26027	4 1/2"	54"	117.00	YARD	20	26523	1"	54"	59.80	YARD	7
26030	2"	54"	139.00	YARD	21	26534	8"	52"	149.00	YARD	30
26034	21 1/2"	55"	99.00	YARD		26553	13"	54"	97.00	YARD	13
26035	31"	55"	248.00	YARD	38	26558	1 1/2"	51"	119.00	YARD	21
26059		54"	189.00	YARD	18	26575		57"	137.00	YARD	15
26072	13 1/2"	54"	55.00	YARD	9	26581	15 1/2"	56"	55.00	YARD	
26076		55"	179.00	YARD	21	26603	2"	54"	99.80	YARD	5
26079		55"	159.00	YARD	19	26629		54"	33.00	YARD	
26080	17 1/2"	54"	129.00	YARD	17	26659		55"	149.00	YARD	17
26082	9"	55"	256.00	YARD		26669		54"	39.00	YARD	
26093	12 1/2"	50"	165.00	YARD	33	26671	6"	54"	35.00	YARD	
26105		54"	93.00	YARD	16	26672		54"	139.00	YARD	30
26106		55"	169.00	YARD	17	26687		59"	39.90	YARD	10
26116	6 1/2"	54"	89.80	YARD	13	26691	2"	54"	159.00	YARD	24
26117		55"	236.00	YARD	26	26692	1"	54"	129.00	YARD	15
26118	4 1/2"	54"	99.00	YARD	12	26693	17 1/2"	54"	159.00	YARD	20

Prices herein quoted are suggested retail. Prices are subject to change without notice. All shipping and special processing charges are additional.

US Retail Price List - August 2016

Pattern	Repeat	Width	Price	UOM	Grade	Pattern	Repeat	Width	Price	UOM	Grade	
26694		5"	54"	149.00	YARD	18	26950		54"	79.80	YARD	5
26704		9"	54"	99.00	YARD	10	26956	8 1/2"	54"	49.00	YARD	8
26705		6"	54"	129.00	YARD	17	26969	10"	54"	67.00	YARD	12
26708			56"	79.80	YARD	5	26970	11 1/2"	54"	57.00	YARD	5
26710			57"	79.00	YARD	5	27015		55"	59.00	YARD	5
26713	13 1/2"		54"	115.00	YARD	16	27032	19"	54"	55.90	YARD	13
26714	25 1/2"		54"	135.00	YARD	23	27044	26"	55"	316.00	YARD	57
26715		4"	56"	95.00	YARD	20	27048	14 1/2"	55"	45.00	YARD	
26716	3 1/2"		54"	139.00	YARD	18	27049		55"	37.50	YARD	7
26717	17 1/2"		54"	99.00	YARD	17	27050		57"	45.00	YARD	7
26720		1"	54"	135.00	YARD	15	27056		54"	99.00	YARD	5
26725		11"	54"	119.00	YARD	17	27059		54"	37.00	YARD	6
26726		17"	54"	119.00	YARD	16	27064		54"	169.00	YARD	16
26733			54"	149.00	YARD	21	27066		54"	169.00	YARD	17
26736		11"	54"	129.00	YARD	33	27067	9"	54"	149.00	YARD	16
26741	11 1/2"		54"	39.80	YARD	7	27068	7 1/2"	54"	139.00	YARD	16
26742		9"	54"	129.00	YARD	33	27071		54"	236.00	YARD	32
26743		6"	54"	29.00	YARD	11	27082	14 1/2"	54"	139.00	YARD	19
26746			60"	21.90	YARD	8	27083	2"	54"	169.00	YARD	22
26748		10"	57"	65.00	YARD	14	27087	4"	54"	129.00	YARD	15
26749	14 1/2"		58"	65.00	YARD	12	27089		54"	97.00	YARD	16
26750			60"	37.00	YARD	6	27091	15 1/2"	52"	220.00	YARD	51
26752		12"	54"	175.00	YARD	26	27092		54"	129.00	YARD	14
26760			54"	169.00	YARD	23	27094		54"	115.00	YARD	14
26766			54"	149.00	YARD	23	27095	26 1/2"	54"	119.00	YARD	21
26768	17 1/2"		54"	159.00	YARD	18	27096	13 1/2"	55"	79.00	YARD	16
26772		12"	50"	179.00	YARD	29	27098	9 1/2"	1/2"	97.00	YARD	13
26773	11 1/2"		54"	129.00	YARD	18	27099		54"	99.80	YARD	14
26774	13 1/2"		54"	169.00	YARD	25	27100		54"	89.80	YARD	11
26782			54"	159.00	YARD	20	27105		54"	79.00	YARD	12
26783			54"	169.00	YARD	22	27114		54"	67.00	YARD	5
26784		5"	54"	119.00	YARD	15	27120		54"	55.00	YARD	5
26801		5"	54"	119.00	YARD	20	27125		54"	77.00	YARD	5
26803		4"	54"	159.00	YARD	22	27126		54"	99.80	YARD	5
26804	2 1/2"		54"	119.00	YARD	5	27127		54"	45.00	YARD	5
26824	13 1/2"		54"	33.00	YARD		27130		55"	39.80	YARD	5
26825	6 1/2"		54"	33.00	YARD		27136		54"	73.00	YARD	15
26826		24"	54"	39.80	YARD		27148		54"	159.00	YARD	28
26827		9"	54"	39.90	YARD	5	27179		55"	496.00	YARD	71
26828			55"	35.90	YARD	12	27182		55"	264.00	YARD	28
26833			55"	137.00	YARD		27187		54"	256.00	YARD	38
26837			54"	59.90	YARD	5	27190	12 1/2"	54"	99.00	YARD	15
26838			54"	57.00	YARD	8	27200	29"	54"	149.00	YARD	19
26841		4"	55"	49.00	YARD	6	27201	10"	55"	149.00	YARD	18
26845	15 1/2"		55"	77.00	YARD	9	27203	22"	54"	368.00	YARD	75
26848	1 1/2"		56"	45.00	YARD	5	27213	22 1/2"	53"	316.00	YARD	
26852			56"	49.80	YARD	5	27214		54"	149.00	YARD	19
26853	16 1/2"		55"	268.00	YARD	59	27233		55"	179.00	YARD	31
26861			54"	79.80	YARD	12	27243	4"	54"	99.80	YARD	15
26869		14"	54"	99.00	YARD	19	27245		54"	119.00	YARD	22
26876		28"	54"	59.80	YARD	14	27246	10 1/2"	54"	139.00	YARD	22
26895			56"	39.80	YARD	5	27249	17"	54"	530.00	YARD	107
26898		1"	54"	99.00	YARD	5	27254	7"	59"	316.00	YARD	42
26899		3"	54"	69.90	YARD	17	27256		55"	199.00	YARD	19
26901			54"	95.00	YARD	5	27257	9 1/2"	53"	159.00	YARD	16
26904	13 1/2"		54"	39.80	YARD	10	27258	13 1/2"	55"	99.00	YARD	18
26907	5 1/2"		54"	69.80	YARD	18	27266		52"	316.00	YARD	45
26912		10"	57"	45.00	YARD		27267		52"	328.00	YARD	47
26913		3"	55"	45.00	YARD	5	27269		55"	199.00	YARD	18
26914			54"	49.80	YARD	16	27279	27"	55"	49.00	YARD	10
26915		9"	54"	45.00	YARD	11	27287	14"	54"	105.00	YARD	22
26918	13 1/2"		54"	69.80	YARD	16	27292		53"	316.00	YARD	56
26945			54"	49.80	YARD	9	27298	15"	53"	296.00	YARD	56

Prices herein quoted are suggested retail. Prices are subject to change without notice. All shipping and special processing charges are additional.

US Retail Price List - August 2016

Pattern	Repeat	Width	Price	UOM	Grade	Pattern	Repeat	Width	Price	UOM	Grade		
27313	11	1/2"	54"	195.00	YARD	38 27682		54"	220.00	YARD	35		
27315		7"	54"	220.00	YARD	32 27683		54"	145.00	YARD	27		
27321			56"	39.00	YARD	5 27728		1/2"	87.00	YARD	12		
27325	13	1/2"	56"	39.00	YARD	15 27729		5"	55"	115.00	YARD	15	
27333			53"	99.00	YARD	23 27732	6	1/2"	55"	99.80	YARD	16	
27342	1	1/2"	51"	159.00	YARD	25 27742		7"	54"	119.00	YARD	16	
27343			54"	119.00	YARD	14 27746	5	1/2"	54"	197.00	YARD	34	
27344		7"	56"	139.00	YARD	15 27751		54"	270.00	YARD	37		
27348		27"	51"	149.00	YARD	26 27763		54"	199.00	YARD	28		
27368			55"	115.00	YARD	30 27769		20"	54"	75.00	YARD	10	
27373	13	1/2"	54"	159.00	YARD	24 27772	43	1/2"	54"	328.00	YARD	88	
27382		5"	54"	149.00	YARD	21 27773	13	1/2"	54"	298.00	YARD	51	
27389		11"	54"	99.00	YARD	18 27776		1"	55"	550.00	YARD	92	
27397		27"	54"	99.00	YARD	18 27779		55"	175.00	YARD	46		
27432	26	3/8"	54"	278.00	YARD	45 27780		55"	199.00	YARD	36		
27452	7	1/2"	54"	45.00	YARD	13 27782		54"	220.00	YARD	34		
27462	8	1/2"	56"	336.00	YARD	43 27783		54"	199.00	YARD	34		
27467			54"	99.00	YARD	5 27790		54"	119.00	YARD	14		
27476	4	1/2"	54"	179.00	YARD	25 27794		12"	54"	99.00	YARD	16	
27480		25"	55"	159.00	YARD	21 27801		54"	59.90	YARD	9		
27481		4"	55"	99.00	YARD	14 27805		54"	37.00	YARD	6		
27482		20"	54"	109.00	YARD	18 27812		55"	276.00	YARD	57		
27483			55"	199.00	YARD	22 27813	26"	55"	276.00	YARD	51		
27487	23	1/2"	51"	250.00	YARD	23 27831		135"	157.00	YARD	27		
27490			54"	197.00	YARD	28 27834		54"	129.00	YARD	27		
27493		23"	52"	298.00	YARD	52 27846		56"	57.00	YARD	13		
27495		10"	47"	348.00	YARD	78 27847		58"	53.00	YARD	12		
27500		9"	54"	49.00	YARD	6 27850		54"	139.00	YARD	13		
27502		15"	54"	55.00	YARD	27853		54"	99.00	YARD	16		
27505			54"	159.00	YARD	20 27855		55"	169.00	YARD	16		
27507	13	1/2"	54"	47.00	YARD	27860	2"	52"	298.00	YARD	56		
27509	13	1/2"	54"	49.80	YARD	5 27867		54"	298.00	YARD	50		
27511			55"	248.00	YARD	22 27868		54"	99.00	YARD	24		
27512			55"	119.00	YARD	18 27878		53"	149.00	YARD			
27513			55"	350.00	YARD	40 27879	15"	53"	165.00	YARD	20		
27530		8"	54"	59.80	YARD	14 27883		53"	149.00	YARD	18		
27546			54"	79.80	YARD	11 27884		55"	197.00	YARD	21		
27553			54"	51.90	YARD	11 27885		55"	189.00	YARD	16		
27557			54"	49.00	YARD	10 27902		55"	135.00	YARD	13		
27568			59"	37.00	YARD	6 27908		54"	75.00	YARD	13		
27569		6"	57"	47.00	YARD	10 27915	24	1/2"	54"	159.00	YARD	25	
27588			54"	119.00	YARD	15 27923		13"	54"	248.00	YARD	47	
27591			54"	89.90	YARD	25 27925		25"	56"	15.90	YARD		
27592			54"	220.00	YARD	39 27926		29"	55"	59.00	YARD	12	
27593			53"	157.00	YARD	19 27928	26	1/2"	57"	59.00	YARD	14	
27596			55"	179.00	YARD	33 27934		54"	99.00	YARD	14		
27597			56"	264.00	YARD	28 27936		55"	159.00	YARD	21		
27598			56"	284.00	YARD	29 27937		54"	159.00	YARD	22		
27599		27"	54"	248.00	YARD	54 27940	7	1/2"	54"	59.80	YARD		
27601			54"	59.80	YARD	12 27951		17"	55"	256.00	YARD	43	
27619			54"	49.00	YARD	11 27952		54"	119.00	YARD	26		
27629			54"	199.00	YARD	18 27961		5"	55"	197.00	YARD	42	
27630			55"	199.00	YARD	17 27964		27"	56"	75.00	YARD		
27644			55"	169.00	YARD	17 27966		13"	56"	87.00	YARD	11	
27645		36"	59"	67.00	YARD	14 27968		3"	55"	58.90	YARD	5	
27646			54"	39.90	YARD	6 27969		56"	298.00	YARD	35		
27647			54"	33.00	YARD	27970		7"	56"	59.00	YARD	5	
27650		2	1/2"	55"	165.00	YARD	20 27973	27	1/2"	55"	97.00	YARD	14
27656			54"	129.00	YARD	17 27975		3"	54"	149.00	YARD	22	
27661		17	1/2"	54"	316.00	YARD	58 27979	15"	58"	69.00	YARD		
27664			54"	396.00	YARD	50 27984		56"	220.00	YARD	30		
27672			54"	149.00	YARD	18 27986		56"	296.00	YARD	36		
27675			55"	149.00	YARD	15 27990		60"	99.80	YARD	13		

Prices herein quoted are suggested retail. Prices are subject to change without notice. All shipping and special processing charges are additional.

US Retail Price List - August 2016

Pattern	Repeat	Width	Price	UOM	Grade	Pattern	Repeat	Width	Price	UOM	Grade
27993		54"	39.80	YARD		28288		54"	139.00	YARD	22
27998	3"	55"	69.00	YARD	7	28292		137"	145.00	YARD	19
28006	5"	54"	75.00	YARD	15	28293	15"	3/4"	197.00	YARD	29
28009	18"	53"	65.80	YARD	9	28295		54"	179.00	YARD	34
28010	27"	57"	49.80	YARD	9	28298	25"	54"	149.00	YARD	15
28016	3"	54"	149.00	YARD	18	28301	37 1/2"	52"	199.00	YARD	41
28017	26"	53"	330.00	YARD	67	28303		54"	179.00	YARD	27
28026	6 1/2"	54"	77.00	YARD	11	28304		137"	175.00	YARD	27
28034	2 1/2"	54"	115.00	YARD	14	28307		137"	169.00	YARD	27
28036	7"	55"	99.80	YARD	16	28309		54"	189.00	YARD	26
28037	3" 1/2"		99.80	YARD	5	28311		137"	129.00	YARD	29
28046	13 1/2"	54"	199.00	YARD	32	28314		54"	159.00	YARD	29
28047	6 1/2"	54"	149.00	YARD	18	28319	11 1/2"	54"	99.00	YARD	13
28048		55"	248.00	YARD	16	28320	47"	54"	189.00	YARD	31
28049	7 1/2"	54"	99.00	YARD	12	28321	4"	54"	195.00	YARD	32
28051		53"	258.00	YARD	45	28327	5"	54"	199.00	YARD	32
28058	1 1/2"	55"	264.00	YARD	21	28328	1 1/2"	54"	69.00	YARD	29
28059	5"	54"	97.00	YARD	14	28329		54"	89.80	YARD	11
28060	18"	54"	77.00	YARD	9	28333		54"	57.00	YARD	10
28061		54"	159.00	YARD	21	28338	15 1/4"	137"	29.00	YARD	11
28062	8"	54"	189.00	YARD	23	28341	11 1/2"	54"	39.80	YARD	7
28064	14 1/2"	54"	79.00	YARD	12	28344	14 1/2"	58"	65.00	YARD	13
28067	9"	54"	179.00	YARD	21	28348		56"	49.80	YARD	5
28068	5"	54"	99.00	YARD	13	28349		56"	39.00	YARD	5
28070		54"	89.80	YARD	11	28351		53"	169.00	YARD	23
28086		56"	75.00	YARD	9	28356		54"	220.00	YARD	26
28087		57"	45.00	YARD	7	28381		53"	197.00	YARD	22
28088		56"	39.00	YARD	5	28390		59"	264.00	YARD	27
28089	7 1/2"	54"	95.00	YARD	16	28394		53"	264.00	YARD	42
28092	10"	54"	119.00	YARD	13	28397		53"	298.00	YARD	42
28104	7"	58"	129.00	YARD	17	28400		55"	157.00	YARD	22
28105	4"	52"	139.00	YARD	25	28402		55"	264.00	YARD	32
28109	3 1/2"	54"	89.80	YARD	16	28404		54"	149.00	YARD	15
28120	1 1/2"	54"	95.00	YARD	5	28418		54"	139.00	YARD	23
28176	3 1/2"	53"	159.00	YARD	24	28420		137"	129.00	YARD	13
28180	2"	54"	149.00	YARD	16	28423		54"	97.00	YARD	23
28182	1 1/2"	55"	75.00	YARD	7	28430		54"	115.00	YARD	26
28187	7"	54"	119.00	YARD	34	28432		54"	149.90	YARD	27
28193	9"	56"	149.00	YARD	17	28434	12"	54"	99.00	YARD	16
28194		54"	199.00	YARD	31	28436	25"	54"	99.00	YARD	17
28200	11 1/2"	54"	199.00	YARD	37	28438		54"	99.00	YARD	5
28203	10"	50"	155.00	YARD	48	28439		54"	99.00	YARD	5
28206	8"	54"	199.00	YARD	37	28442	20"	54"	99.00	YARD	
28217	26"	54"	117.00	YARD	21	28458	8"	54"	197.00	YARD	25
28218	9"	54"	159.00	YARD	21	28459	8"	54"	197.00	YARD	23
28220		54"	149.00	YARD	18	28464	2 1/2"	54"	99.00	YARD	5
28222	1"	53"	159.00	YARD	23	28478		54"	199.00	YARD	23
28230	1"	56"	45.00	YARD		28479		54"	129.00	YARD	15
28234	4 1/2"	54"	159.00	YARD	20	28480	17"	54"	139.00	YARD	20
28237		54"	149.00	YARD	27	28498		51"	179.00	YARD	24
28238	10"	54"	159.00	YARD	19	28504	15 1/2"	54"	159.00	YARD	26
28243	12 1/2"	55"	185.00	YARD	22	28506		139"	39.00	YARD	
28250		55"	129.00	YARD	17	28507	3"	55"	39.00	YARD	
28254		54"	79.80	YARD	5	28508		54"	119.00	YARD	17
28257		54"	175.00	YARD	28	28512	7"	54"	89.00	YARD	12
28260	6"	52"	99.00	YARD	21	28513		54"	61.90	YARD	11
28262	1"	52"	179.00	YARD	23	28518		54"	69.00	YARD	13
28268	5 1/2"	54"	199.00	YARD	34	28520		54"	53.00	YARD	10
28276	1"	54"	95.00	YARD	22	28522		54"	85.00	YARD	15
28282	9 1/2"	55"	159.00	YARD	31	28523	2 1/2"	54"	69.00	YARD	11
28284	5 1/2"	54"	199.00	YARD	31	28524		54"	69.80	YARD	14
28285		54"	129.00	YARD	17	28531		55"	65.50	YARD	13
28287	5"	54"	149.00	YARD	29	28538	26 1/2"	54"	199.00	YARD	52

Prices herein quoted are suggested retail. Prices are subject to change without notice. All shipping and special processing charges are additional.

US Retail Price List - August 2016

Pattern	Repeat	Width	Price	UOM	Grade	Pattern	Repeat	Width	Price	UOM	Grade		
28574	17	1/2"	58"	129.00	YARD	18	28755	2	1/2"	54"	85.00	YARD	18
28585	10	1/2"	53"	45.90	YARD	15	28756	1"	54"	89.80	YARD	12	
28597	7	1/2"	56"	29.00	YARD		28757	3	1/2"	54"	89.80	YARD	13
28598	11	1/2"	54"	65.00	YARD	18	28758		55"	89.00	YARD	5	
28604			54"	137.00	YARD	22	28764	2	1/2"	53"	99.00	YARD	19
28605			54"	99.80	YARD	17	28766		61"	276.00	YARD		
28615		15"	54"	45.00	YARD	11	28767		1/2"	79.90	YARD	5	
28621		118"	59.00	YARD			28768	2	1/2"	3/4"	75.00	YARD	10
28628		1"	54"	149.00	YARD	19	28769		4"	1/2"	85.00	YARD	5
28634		29"	54"	230.00	YARD	56	28770		56"	99.00	YARD	17	
28636			54"	364.00	YARD	45	28771	16	1/2"	55"	97.00	YARD	12
28640	10	1/2"	51"	248.00	YARD	43	28772		1"	54"	99.80	YARD	12
28643			55"	220.00	YARD	24	28773		9"	56"	149.00	YARD	25
28645	4	1/2"	54"	298.00	YARD	47	28776		2"	58"	149.00	YARD	17
28647		2"	56"	290.00	YARD	32	28778		1"	56"	139.00	YARD	17
28649			55"	169.00	YARD	22	28780		17"	52"	149.00	YARD	23
28655	27	1/2"	54"	236.00	YARD	29	28781		2"	51"	159.00	YARD	25
28657			58"	236.00	YARD	22	28782		27"	53"	149.00	YARD	27
28659		15"	55"	328.00	YARD	63	28783			54"	89.80	YARD	9
28660		8"	54"	199.00	YARD	27	28784	14	1/2"	48"	149.00	YARD	24
28661		16"	54"	189.00	YARD	39	28787			56"	75.00	YARD	12
28664			53"	236.00	YARD	29	28788	39	1/2"	56"	197.00	YARD	28
28670			121"	296.00	YARD	50	28789			55"	97.00	YARD	8
28678			51"	298.00	YARD	35	28790			56"	119.00	YARD	14
28680		2"	54"	256.00	YARD	39	28791			54"	99.80	YARD	14
28687			53"	149.00	YARD	19	28792	2	1/2"	53"	149.00	YARD	20
28689	12	1/2"	55"	99.00	YARD	18	28794			54"	89.80	YARD	14
28691			55"	236.00	YARD	17	28797			54"	220.00	YARD	25
28692		14"	51"	298.00	YARD	51	28798	3	1/2"	53"	396.00	YARD	74
28695	14	1/2"	55"	179.00	YARD	24	28802		1/2"	109.00	YARD	19	
28696		43"	59"	248.00	YARD	31	28804			57"	89.80	YARD	9
28697			57"	197.00	YARD	22	28805	1	1/2"	56"	97.00	YARD	13
28699	20	1/2"	54"	99.80	YARD	13	28810			54"	38.90	YARD	8
28700	26	1/2"	54"	316.00	YARD	52	28814		19"	55"	145.00	YARD	20
28701		1"	54"	336.00	YARD	61	28816		4"	54"	189.00	YARD	
28704			54"	175.00	YARD	30	28820			55"	197.00	YARD	20
28709			55"	296.00	YARD	33	28825	13	1/2"	54"	199.00	YARD	44
28711		28"	1/2"	468.00	YARD	75	28827			50"	199.00	YARD	29
28712		2"	54"	430.00	YARD	53	28828		4"	52"	256.00	YARD	42
28719	3	1/2"	1/2"	99.80	YARD	16	28829			54"	159.00	YARD	25
28720			54"	49.00	YARD	8	28830			54"	159.00	YARD	28
28723	1	1/2"	54"	129.00	YARD	16	28832			54"	159.90	YARD	34
28725			1/2"	149.00	YARD	17	28834		21"	54"	264.00	YARD	45
28727	5	1/2"	57"	95.00	YARD	13	28836		6"	57"	139.00	YARD	17
28730	6	1/2"	54"	169.00	YARD	25	28844	25	1/2"	51"	195.00	YARD	33
28731	13	1/2"	54"	149.00	YARD	22	28851		13"	58"	220.00	YARD	
28732	6	1/2"	1/2"	139.00	YARD	20	28853			54"	49.00	YARD	11
28733	12	1/2"	1/2"	149.00	YARD	18	28864			54"	99.00	YARD	14
28734	2	1/2"	1/2"	149.00	YARD	18	28865			55"	95.00	YARD	14
28735			58"	149.00	YARD	18	28866	26	1/2"	54"	169.00	YARD	26
28738	7	1/2"	55"	376.00	YARD	55	28870		14"	55"	179.00	YARD	22
28739		3"	57"	129.00	YARD	15	28877		34"	55"	248.00	YARD	48
28741			1/2"	117.00	YARD	13	28878	19	1/2"	53"	248.00	YARD	37
28742		5"	57"	159.00	YARD	24	28879		21"	57"	316.00	YARD	71
28744			1/2"	177.00	YARD	22	28880			55"	348.00	YARD	51
28745			1/2"	177.00	YARD	24	28881		1"	55"	159.00	YARD	17
28747			1/2"	165.00	YARD	19	28882		4"	53"	236.00	YARD	38
28748			54"	169.00	YARD	19	28887		4"	54"	197.00	YARD	30
28749		14"	1/2"	149.00	YARD	23	28891		26"	54"	296.00	YARD	47
28750		8"	1/2"	149.00	YARD	19	28893			55"	33.00	YARD	
28751			53"	137.00	YARD	20	28895		1"	55"	296.00	YARD	35
28752			57"	67.00	YARD	5	28897	16	1/2"	53"	296.00	YARD	38
28754		26"	54"	149.00	YARD	20	28898		1"	55"	516.00	YARD	95

Prices herein quoted are suggested retail. Prices are subject to change without notice. All shipping and special processing charges are additional.

US Retail Price List - August 2016

Pattern	Repeat	Width	Price	UOM	Grade	Pattern	Repeat	Width	Price	UOM	Grade
28899		55"	139.00	YARD		29191	6 1/2"	1/2"	169.00	YARD	25
28901	6"	55"	199.00	YARD		29193	3"	1/2"	129.00	YARD	20
28904	3 1/2"	54"	296.00	YARD	51	29198		54"	149.00	YARD	15
28907		55"	99.00	YARD	12	29199	5 1/2"	57"	129.00	YARD	22
28911	16"	55"	250.00	YARD	50	29200	7 1/2"	56"	159.00	YARD	21
28912	46"	54"	248.00	YARD	41	29203	1"	1/2"	119.00	YARD	18
28919		54"	59.90	YARD	14	29204		54"	79.80	YARD	9
28922		54"	33.00	YARD		29209		56"	119.80	YARD	24
28928	28"	54"	296.00	YARD	55	29210	1"	54"	139.00	YARD	21
28929	46"	55"	296.00	YARD	53	29212	32 1/2"	55"	169.00	YARD	27
28931	6 1/2"	1/2"	298.00	YARD	40	29214	7"	54"	470.00	YARD	66
28937	7"	54"	199.00	YARD	53	29216	2"	54"	149.00	YARD	21
28949		54"	41.90	YARD	11	29217	15 1/2"	52"	169.00	YARD	27
28953		54"	27.90	YARD	5	29218	7"	54"	129.00	YARD	18
28966	4 1/2"	54"	169.00	YARD		29220		54"	119.00	YARD	14
28969	3 1/2"	55"	43.90	YARD	15	29221		54"	129.00	YARD	14
28972	6"	58"	33.90	YARD	13	29223	15 1/2"	54"	79.80	YARD	
28975		54"	45.00	YARD	11	29227	2"	54"	139.00	YARD	18
28985	27"	54"	296.00	YARD	50	29238	18 1/2"	57"	139.00	YARD	30
28997		54"	59.00	YARD		29239		54"	53.00	YARD	5
29022	4"	54"	47.90	YARD	11	29240		54"	53.00	YARD	9
29023		54"	59.90	YARD	14	29244	2 1/2"	55"	89.80	YARD	16
29033	15"	52"	189.00	YARD		29261	14"	54"	169.00	YARD	25
29035	14 1/2"	54"	248.00	YARD	37	29265	12 1/2"	54"	348.00	YARD	49
29036		54"	288.00	YARD	36	29267	8"	52"	270.00	YARD	41
29037		54"	189.00	YARD	33	29270	5"	54"	159.00	YARD	17
29038	4"	54"	79.00	YARD	5	29272		55"	199.00	YARD	23
29040	3"	53"	79.00	YARD	5	29274	23"	53"	336.00	YARD	63
29041	5"	54"	79.00	YARD	5	29280	28"	54"	189.00	YARD	53
29042	3"	54"	79.00	YARD	5	29287	12"	56"	59.80	YARD	12
29052	1 1/2"	54"	99.00	YARD	17	29290	22"	54"	177.00	YARD	39
29068	9"	54"	264.00	YARD	41	29291	15"	54"	149.00	YARD	29
29073	21"	54"	129.00	YARD	25	29293	18"	54"	256.00	YARD	49
29079	20 1/2"	54"	159.00	YARD	28	29300		54"	197.00	YARD	24
29080	12"	54"	149.00	YARD	26	29304		55"	264.00	YARD	
29081	3"	54"	169.00	YARD	26	29315	5 1/2"	54"	248.00	YARD	27
29089	3"	54"	99.80	YARD		29316		55"	169.00	YARD	19
29098	1"	59"	139.00	YARD	18	29317	1"	54"	95.00	YARD	17
29101	6 1/2"	59"	129.00	YARD	20	29322	14"	54"	284.00	YARD	49
29104		54"	11.90	YARD		29327		55"	75.90	YARD	17
29105	10"	1/2"	159.00	YARD	23	29329	26"	54"	220.00	YARD	43
29107	2 1/2"	54"	89.00	YARD	15	29335	18"	54"	199.00	YARD	47
29111	5 1/2"	54"	89.80	YARD	15	29342	4 1/2"	48"	199.00	YARD	30
29114		54"	95.00	YARD	17	29343		54"	129.00	YARD	20
29119	13 1/2"	54"	119.00	YARD	25	29346	4 1/2"	54"	99.80	YARD	16
29120	3"	54"	119.00	YARD	20	29349		54"	189.00	YARD	23
29122		54"	85.00	YARD	15	29356	1 1/2"	54"	99.00	YARD	12
29128		54"	89.00	YARD	15	29359	4"	57"	169.00	YARD	23
29130	1"	54"	87.00	YARD	17	29362	11"	54"	197.00	YARD	36
29131	27"	54"	149.00	YARD	26	29366		52"	139.00	YARD	21
29134	2"	54"	79.80	YARD	12	29367	3"	53"	336.00	YARD	60
29139		54"	119.00	YARD	15	29373	3"	54"	139.00	YARD	22
29143	12 1/2"	54"	99.00	YARD	15	29376	13"	54"	348.00	YARD	71
29146		54"	69.80	YARD	5	29378	7"	54"	149.00	YARD	25
29147		54"	115.00	YARD		29381		54"	69.00	YARD	13
29151		55"	79.80	YARD	5	29391	8"	54"	97.00	YARD	13
29152	6"	54"	159.00	YARD	18	29393	2"	57"	197.00	YARD	28
29160		54"	169.00	YARD		29395		54"	179.00	YARD	20
29170	2"	54"	97.00	YARD	20	29407		54"	75.90	YARD	5
29183	6 1/2"	52"	169.00	YARD	24	29423		55"	199.00	YARD	32
29186	8"	1/2"	149.00	YARD	21	29424		55"	220.00	YARD	37
29187		56"	149.00	YARD	20	29428		54"	79.00	YARD	14
29189	11"	59"	129.00	YARD	18	29429		54"	85.00	YARD	15

Prices herein quoted are suggested retail. Prices are subject to change without notice. All shipping and special processing charges are additional.

US Retail Price List - August 2016

Pattern	Repeat	Width	Price	UOM	Grade	Pattern	Repeat	Width	Price	UOM	Grade	
29431		54"	75.00	YARD	13	29575		149"	99.00	YARD	12	
29436		54"	49.00	YARD	5	29576		58"	197.00	YARD	24	
29438	5 1/2"	54"	296.00	YARD	32	29579		3"	52"	75.00	YARD	11
29439	15 1/2"	54"	296.00	YARD	38	29580	10 1/2"	54"	69.00	YARD	14	
29440		1"	54"	370.00	YARD	45	29581	3 1/2"	54"	79.80	YARD	10
29445	27 1/2"	57"	220.00	YARD	32	29582		54"	99.80	YARD	14	
29447		14"	55"	139.00	YARD			55"	99.80	YARD	13	
29450		7"	54"	169.00	YARD	20	29594	28"	54"	189.00	YARD	
29451	7 1/2"	55"	396.00	YARD	54	29596		3"	54"	169.00	YARD	
29454		57"	228.00	YARD	35	29604		55"	284.00	YARD	33	
29458		55"	330.00	YARD	44	29611		54"	139.00	YARD	18	
29464		54"	220.00	YARD	31	29618		55"	248.00	YARD		
29467		130"	199.00	YARD	35	29619		55"	169.00	YARD	21	
29469	1"	137"	169.00	YARD	36	29624		54"	169.00	YARD	24	
29471		54"	248.00	YARD	39	29626	12"	53"	199.00	YARD	31	
29475		55"	236.00	YARD	17	29627	24"	53"	197.00	YARD	34	
29478		55"	256.00	YARD	29	29629		54"	248.00	YARD	24	
29479		55"	149.00	YARD	21	29646		56"	67.00	YARD	5	
29480		55"	189.00	YARD	20	29649		55"	149.00	YARD	22	
29481		139"	173.00	YARD	15	29671		53"	149.00	YARD	32	
29484		54"	99.00	YARD	5	29674		54"	75.00	YARD	13	
29493	6 1/2"	55"	149.00	YARD	20	29685	22 1/2"	55"	199.00	YARD	32	
29501		54"	159.00	YARD	21	29687		54"	99.80	YARD	5	
29504		55"	284.00	YARD	37	29690		56"	264.00	YARD	26	
29505		54"	220.00	YARD	27	29694		54"	99.00	YARD	25	
29506		55"	350.00	YARD	40	29701		54"	27.90	YARD	11	
29507		55"	248.00	YARD	24	29702		54"	89.90	YARD	25	
29508		55"	248.00	YARD	25	29703		55"	139.00	YARD	23	
29510		57"	199.00	YARD	23	29717		53"	396.00	YARD	78	
29512		54"	99.80	YARD	21	29730	12 1/2"	54"	179.00	YARD	15	
29513		58"	197.00	YARD	17	29731		54"	55.00	YARD	5	
29514		1/2"	169.00	YARD	14	29732		54"	49.00	YARD	5	
29520		1/2"	199.00	YARD	33	29736		54"	63.90	YARD	5	
29521		54"	199.00	YARD	25	29741		54"	45.90	YARD	9	
29522	15"	55"	79.00	YARD	23	29744		55"	59.80	YARD	5	
29524		49"	296.00	YARD	47	29745		56"	55.00	YARD	5	
29526		55"	248.00	YARD	45	29755		56"	49.90	YARD	5	
29528		54"	199.00	YARD	29	29758		54"	99.80	YARD	16	
29532		135"	159.00	YARD	23	29759	3 1/2"	54"	39.90	YARD	5	
29533	3"	53"	79.00	YARD	11	29761		55"	65.00	YARD	11	
29534		139"	149.00	YARD	36	29763		56"	49.90	YARD	5	
29535	3"	54"	256.00	YARD	46	29800		54"	129.00	YARD	20	
29536		139"	169.00	YARD	13	29805		54"	97.00	YARD	5	
29537		55"	220.00	YARD	40	29806		54"	59.80	YARD	5	
29538	29 1/2"	52"	79.00	YARD	13	29811		55"	199.00	YARD	27	
29539		55"	169.00	YARD	18	29812	1"	54"	149.00	YARD	35	
29542	14"	55"	69.00	YARD	8	29814		55"	199.00	YARD	23	
29543		55"	248.00	YARD	25	29818		54"	256.00	YARD	34	
29544		139"	139.00	YARD	25	29820		55"	316.00	YARD	39	
29545	2"	56"	290.00	YARD	29	29821	20 1/2"	54"	250.00	YARD	36	
29548		121"	296.00	YARD	49	29822		55"	399.00	YARD	48	
29549		55"	199.00	YARD	19	29823		55"	199.00	YARD	23	
29550		56"	197.00	YARD	23	29824		55"	298.00	YARD	30	
29552		55"	159.00	YARD	22	29827		59"	199.00	YARD	33	
29554	2"	54"	159.00	YARD	21	29828		55"	169.00	YARD	17	
29560		7"	54"	129.00	YARD	15	29831	18"	54"	236.00	YARD	47
29561		16"	54"	149.00	YARD	23	29834		55"	356.00	YARD	41
29566	2 1/2"	54"	149.00	YARD	20	29838		54"	248.00	YARD	26	
29568	14 1/2"	54"	99.00	YARD	18	29839		54"	316.00	YARD	44	
29569		6"	54"	99.00	YARD	16	29841	13 1/2"	54"	296.00	YARD	52
29570	1"	130"	236.00	YARD	41	29844		6"	54"	270.00	YARD	48
29573		54"	59.80	YARD		29845		14"	55"	316.00	YARD	43
29574	13 1/2"	54"	99.00	YARD	5	29846		54"	248.00	YARD	26	

Prices herein quoted are suggested retail. Prices are subject to change without notice. All shipping and special processing charges are additional.

US Retail Price List - August 2016

Pattern	Repeat	Width	Price	UOM	Grade	Pattern	Repeat	Width	Price	UOM	Grade
29847		55"	316.00	YARD	35	29938	12"	55"	139.00	YARD	21
29848	1 1/2"	51"	199.00	YARD	30	29941		54"	139.00	YARD	17
29850	6"	54"	179.00	YARD	26	29946		54"	189.00	YARD	25
29854		54"	99.00	YARD	20	29947	1"	54"	149.00	YARD	23
29855	1 1/2"	53"	199.00	YARD	33	29950	25"	56"	349.00	YARD	56
29858	11"	49"	316.00	YARD	60	29951		54"	199.00	YARD	28
29859	6"	55"	296.00	YARD	46	29952	10"	54"	129.00	YARD	20
29860	8 1/2"	52"	236.00	YARD	36	29953		56"	348.00	YARD	44
29862	3"	49"	264.00	YARD	49	29956	15 1/4"	57"	115.00	YARD	19
29863	7 1/2"	49"	336.00	YARD	66	29959	4 1/2"	56"	139.00	YARD	17
29864		55"	189.00	YARD	32	29960		51"	149.00	YARD	22
29868	12"	49"	264.00	YARD	46	29961	35"	54"	197.00	YARD	35
29869	6 1/2"	55"	199.00	YARD	22	29962	6 1/2"	56"	99.00	YARD	12
29870	1 1/2"	55"	316.00	YARD	49	29963		56"	139.00	YARD	15
29871		55"	220.00	YARD	39	29964	18"	51"	157.00	YARD	25
29872	1 1/2"	54"	220.00	YARD	37	29965	9"	56"	157.00	YARD	24
29873		58"	149.00	YARD	17	29966	6 1/2"	55"	139.00	YARD	15
29874	1"	54"	149.00	YARD	24	29970	8 1/2"	57"	119.00	YARD	17
29875		55"	236.00	YARD	28	29971		56"	284.00	YARD	28
29876		55"	159.00	YARD	19	29975	1 1/2"	52"	169.00	YARD	24
29878		55"	149.00	YARD	19	29977	2"	54"	169.00	YARD	21
29879		55"	159.00	YARD	18	29978	2"	55"	119.00	YARD	15
29880		53"	129.00	YARD	31	29980	4"	55"	129.00	YARD	17
29881		56"	149.00	YARD	17	29982	2 1/2"	56"	149.00	YARD	22
29882		56"	149.00	YARD	20	29983	6 1/2"	56"	169.00	YARD	21
29883	6"	51"	159.00	YARD	29	29986	13"	57"	99.00	YARD	17
29885		55"	220.00	YARD	24	29987		54"	159.00	YARD	21
29886		54"	119.00	YARD	24	29991	3 1/2"	56"	149.00	YARD	17
29889		54"	99.00	YARD	11	29992	3 1/2"	54"	119.00	YARD	5
29891		54"	39.80	YARD	10	29993	14"	56"	119.00	YARD	17
29892		54"	59.90	YARD	14	29995	2 1/2"	54"	99.00	YARD	5
29893		55"	41.90	YARD	10	29996	27"	55"	159.00	YARD	26
29896		54"	129.00	YARD	23	30001	7"	55"	159.00	YARD	22
29897		53"	137.00	YARD	26	30002	2 1/2"	56"	129.00	YARD	16
29898	2"	55"	169.00	YARD	21	30003	2"	54"	169.00	YARD	23
29899		57"	220.00	YARD	27	30004		57"	99.00	YARD	12
29900	12 1/2"	56"	299.00	YARD	42	30005	2"	51"	169.00	YARD	26
29902	18"	51"	199.00	YARD	43	30007	1"	57"	139.00	YARD	17
29903	6"	49"	248.00	YARD	38	30008	1 1/2"	53"	139.00	YARD	26
29904		55"	220.00	YARD	26	30009		54"	298.00	YARD	37
29906		51"	228.00	YARD	38	30010	6 1/2"	54"	99.00	YARD	16
29907		56"	99.00	YARD	11	30016		54"	79.00	YARD	16
29908		58"	99.00	YARD	11	30020	27 1/2"	54"	159.00	YARD	27
29909		57"	119.00	YARD	14	30023		55"	115.00	YARD	15
29910	7"	57"	149.00	YARD	18	30024		54"	99.00	YARD	17
29912	10"	56"	139.00	YARD	18	30025	20"	54"	149.00	YARD	23
29913	4 1/2"	56"	149.00	YARD	19	30026		54"	139.00	YARD	19
29915	9"	52"	159.00	YARD	21	30028		54"	119.00	YARD	16
29916	12 1/2"	51"	149.00	YARD	23	30029	2"	54"	159.00	YARD	23
29917	1 1/2"	54"	149.00	YARD	19	30031		54"	139.00	YARD	
29920		54"	139.00	YARD	22	30032	7 1/2"	54"	149.00	YARD	20
29921	3 1/2"	55"	250.00	YARD	31	30033		54"	139.00	YARD	18
29922	13 1/2"	55"	169.00	YARD	24	30036		54"	99.00	YARD	13
29923	25"	53"	189.00	YARD	38	30038	3"	54"	99.00	YARD	15
29925		53"	256.00	YARD	34	30039	8"	54"	139.00	YARD	19
29927	1"	53"	149.00	YARD	23	30041	6"	54"	139.00	YARD	20
29930		54"	99.00	YARD	11	30042	21"	54"	135.00	YARD	23
29931		58"	109.00	YARD	15	30045	20"	56"	129.00	YARD	21
29932	3 1/2"	56"	99.00	YARD	12	30046	9"	57"	129.00	YARD	18
29933		57"	99.00	YARD	15	30048		53"	99.00	YARD	13
29935		56"	115.00	YARD	13	30049	1"	58"	99.00	YARD	14
29936	22 1/2"	57"	149.00	YARD	23	30050		54"	99.00	YARD	18
29937		56"	298.00	YARD	39	30052	6 1/2"	52"	139.00	YARD	24

Prices herein quoted are suggested retail. Prices are subject to change without notice. All shipping and special processing charges are additional.

US Retail Price List - August 2016

Pattern	Repeat	Width	Price	UOM	Grade	Pattern	Repeat	Width	Price	UOM	Grade	
30053		4"	55"	89.00	YARD	11 30208		7"	54"	99.00	YARD	14
30054	6 1/2"	54"	159.00	YARD	20 30210		26"	53"	248.00	YARD	43	
30055		54"	75.00	YARD	5 30211			55"	348.00	YARD	44	
30058	4 1/2"	54"	197.00	YARD	22 30215		14"	54"	298.00	YARD	47	
30059	27 1/2"	54"	139.00	YARD	25 30216		2 1/2"	54"	197.00	YARD	27	
30060	21 1/2"	55"	298.00	YARD	48 30218		27 1/2"	54"	236.00	YARD	46	
30063		11"	54"	296.00	YARD	37 30221		3 1/2"	55"	248.00	YARD	35
30067		21"	55"	396.00	YARD	61 30224		25"	54"	125.00	YARD	18
30070	13 1/2"	54"	119.00	YARD	20 30225			54"	55.00	YARD	9	
30072	12 1/2"	54"	99.00	YARD	16 30227			54"	59.90	YARD	19	
30074		1/2"	298.00	YARD	31 30229		2"	54"	177.00	YARD	24	
30077		58"	179.00	YARD	18 30230			54"	37.90	YARD	13	
30083		53"	298.00	YARD	41 30235			50"	220.00	YARD	33	
30085	8"	52"	197.00	YARD	36 30239		2 1/2"	51"	199.00	YARD	26	
30086	4 1/2"	54"	159.00	YARD	23 30242			15"	50"	248.00	YARD	40
30087	4 1/2"	54"	139.00	YARD	23 30248		9 1/2"	55"	65.90	YARD	14	
30088		1"	54"	149.00	YARD	20 30249			54"	37.50	YARD	7
30089	5 1/2"	54"	159.00	YARD	23 30253			55"	165.00	YARD	18	
30091	2 1/2"	49"	175.00	YARD	30 30255		7 1/2"	47"	390.00	YARD	63	
30094		18"	55"	199.00	YARD	27 30256		15 1/2"	46"	69.90	YARD	25
30096		55"	179.00	YARD	20 30259			55"	37.00	YARD	12	
30099	8 1/2"	54"	97.00	YARD	13 30260		8 1/2"	58"	24.90	YARD	5	
30101	2 1/2"	54"	139.00	YARD	17 30261			11"	57"	41.90	YARD	15
30110		8"	52"	199.00	YARD	30262		2 1/2"	55"	39.00	YARD	15
30111		55"	197.00	YARD	34 30263			3" 1/2"	396.00	YARD	90	
30113		14"	54"	129.00	YARD	15 30265			54"	49.80	YARD	12
30115		9"	54"	169.00	YARD	25 30269		8"	54"	47.00	YARD	16
30120		5"	54"	99.00	YARD	15 30270		11"	54"	67.80	YARD	
30122		26"	51"	199.00	YARD	41 30272		2"	54"	37.90	YARD	10
30126		54"	43.50	YARD	14 30274			56"	43.90	YARD	9	
30130		58"	29.00	YARD	6 30275		12"	51"	336.00	YARD	69	
30132		54"	99.00	YARD	5 30276			54"	99.00	YARD	14	
30134	14 1/2"	54"	97.00	YARD	18 30278			53"	99.00	YARD	22	
30136		54"	99.80	YARD	5 30288		1"	54"	65.00	YARD	14	
30137		54"	59.00	YARD	5 30291			54"	47.80	YARD	10	
30141	18 1/2"	54"	169.00	YARD	28 30292			54"	47.90	YARD	14	
30150		54"	89.80	YARD	13 30293			54"	115.00	YARD	15	
30154		1/2"	159.00	YARD	20 30299			55"	59.90	YARD	18	
30156		54"	95.00	YARD	15 30304		25"	59"	33.90	YARD	9	
30161		1"	54"	99.80	YARD	20 30308			54"	119.00	YARD	14
30163		54"	79.80	YARD	13 30312		15"	51"	244.00	YARD	28	
30166		1"	54"	79.80	YARD	14 30316			54"	53.90	YARD	17
30168		54"	119.00	YARD	5 30318			55"	336.00	YARD	35	
30169		54"	89.80	YARD	14 30320		2"	55"	298.00	YARD	33	
30172	20 1/2"	54"	59.80	YARD	11 30322			55"	149.00	YARD	14	
30173		3"	54"	59.80	YARD	10 30323			54"	85.00	YARD	15
30175		11"	55"	197.00	YARD	22 30325			52"	159.00	YARD	29
30176	27 1/2"	60"	299.00	YARD	43 30327			54"	159.00	YARD	17	
30177	14 1/2"	54"	197.00	YARD	27 30328			54"	129.00	YARD	15	
30178	14 1/2"	54"	197.00	YARD	25 30329			54"	99.80	YARD	18	
30179	14 1/2"	54"	197.00	YARD	25 30336			54"	87.00	YARD	10	
30180		2"	54"	197.00	YARD	24 30337			54"	41.90	YARD	11
30183	15 1/2"	51"	199.00	YARD	35 30338			55"	41.90	YARD		
30185	15 1/2"	51"	149.00	YARD	32 30339			54"	197.00	YARD	21	
30189	13 1/2"	53"	296.00	YARD	47 30341			55"	220.00	YARD	25	
30191	15 1/2"	56"	236.00	YARD	35 30350			54"	139.00	YARD	21	
30192		38"	284.00	YARD	48 30351		15"	52"	197.00	YARD	38	
30195		4"	54"	270.00	YARD	35 30352		15"	52"	197.00	YARD	40
30198		54"	216.00	YARD	38 30356			55"	199.00	YARD	20	
30199		54"	199.00	YARD	23 30357		8 3/4"	54"	169.00	YARD	25	
30201		26"	55"	199.00	YARD	30362			55"	179.00	YARD	20
30205		54"	179.00	YARD	21 30364		13 1/2"	54"	99.00	YARD	21	
30206	15 1/2"	51"	296.00	YARD	43 30366			55"	298.00	YARD	30	

Prices herein quoted are suggested retail. Prices are subject to change without notice. All shipping and special processing charges are additional.

US Retail Price List - August 2016

Pattern	Repeat	Width	Price	UOM	Grade	Pattern	Repeat	Width	Price	UOM	Grade
30367	4"	53"	179.00	YARD		30528	8"	54"	119.00	YARD	15
30368	4 1/2"	54"	179.00	YARD	30	30533	21"	54"	119.00	YARD	18
30369	12 1/2"	54"	139.00	YARD	24	30535		52"	296.00	YARD	37
30370	7"	54"	89.00	YARD	11	30537	20 1/2"	54"	296.00	YARD	39
30372	5"	54"	159.00	YARD	22	30539		52"	296.00	YARD	40
30375		55"	169.00	YARD	21	30550	9"	54"	197.00	YARD	
30378		54"	159.00	YARD		30552	4"	54"	290.00	YARD	42
30379	1 1/2"	52"	149.00	YARD	29	30561	4"	54"	149.00	YARD	
30380	8"	52"	179.00	YARD	28	30569		54"	99.00	YARD	14
30381	7"	54"	159.00	YARD	28	30601		54"	248.00	YARD	30
30383		53"	115.00	YARD	21	30602	51"	54"	298.00	YARD	
30392	7 1/2"	54"	119.00	YARD	21	30614		54"	99.00	YARD	5
30393		55"	129.00	YARD	14	30618		54"	139.00	YARD	
30394		54"	85.00	YARD	17	30620	1 1/2"	54"	75.00	YARD	5
30398	6"	54"	149.00	YARD	18	30621	1 1/2"	54"	85.00	YARD	5
30405		57"	149.00	YARD	20	30622	7 1/2"	54"	149.00	YARD	20
30407	2"	51"	129.00	YARD	15	30623	27 1/2"	54"	139.00	YARD	25
30409	4"	53"	149.00	YARD	25	30624		54"	139.00	YARD	18
30414	13 1/2"	54"	99.00	YARD	20	30625		54"	67.00	YARD	5
30415	1"	53"	169.00	YARD	22	30626	4 1/2"	54"	139.00	YARD	23
30416		55"	220.00	YARD	23	30628	3 1/2"	54"	79.00	YARD	5
30419	4"	54"	97.00	YARD	13	30630		54"	73.00	YARD	5
30421		55"	79.90	YARD	23	30631		54"	119.00	YARD	5
30423		54"	43.90	YARD	11	30635	2"	54"	97.00	YARD	5
30426		54"	47.00	YARD	9	30637	3"	54"	99.80	YARD	5
30428		55"	53.00	YARD	10	30640		56"	67.00	YARD	5
30430		54"	51.90	YARD	14	30642	5 1/2"	56"	87.00	YARD	5
30434		56"	55.90	YARD	12	30643	5"	54"	97.00	YARD	5
30435		54"	84.90	YARD	19	30650		54"	79.80	YARD	5
30444		54"	93.90	YARD	25	30664		54"	55.90	YARD	5
30445		54"	85.00	YARD	19	30665		54"	59.80	YARD	5
30446		54"	55.90	YARD	13	30666	2"	54"	65.00	YARD	5
30447		57"	89.00	YARD	22	30667		54"	59.80	YARD	5
30448		54"	55.90	YARD	17	30669		55"	59.80	YARD	5
30449		54"	99.80	YARD	24	30670		57"	99.00	YARD	5
30451	12"	54"	97.00	YARD	18	30671		55"	99.00	YARD	5
30452	5"	54"	97.00	YARD	17	30673	2"	54"	99.00	YARD	5
30455	1"	54"	248.00	YARD	28	30674	2 1/2"	54"	99.00	YARD	5
30457	2"	55"	97.00	YARD	16	30677	1 1/2"	54"	97.00	YARD	5
30458	1 1/2"	3/4"	99.00	YARD	17	30678	3"	54"	99.00	YARD	5
30459	3 3/4"	58"	99.80	YARD	16	30679	4"	56"	73.00	YARD	5
30465		57"	85.00	YARD	14	30683	3"	56"	95.00	YARD	5
30466		54"	105.00	YARD	19	30685		58"	99.00	YARD	5
30467	1"	57"	149.00	YARD	20	30687	1"	54"	99.00	YARD	5
30470		54"	79.80	YARD	12	30688	1"	54"	99.00	YARD	5
30473	5"	54"	95.00	YARD	14	30690	6"	54"	99.00	YARD	5
30474	1 1/2"	55"	99.00	YARD	12	30691		1/2"	197.00	YARD	
30476	18"	54"	79.80	YARD	16	30692	1"	56"	117.00	YARD	5
30477	28"	54"	89.80	YARD	9	30693	1"	57"	97.00	YARD	5
30478	5 1/2"	54"	79.80	YARD	8	30694	2"	55"	97.00	YARD	5
30479		54"	248.00	YARD	32	30695		54"	99.00	YARD	10
30481	4 1/2"	53"	89.00	YARD	5	30696		54"	89.00	YARD	10
30482		54"	59.80	YARD	10	30698	18 1/2"	56"	109.00	YARD	5
30488		55"	97.00	YARD	13	30702	49"	55"	149.00	YARD	
30494	27"	55"	220.00	YARD	38	30708		1/2"	199.00	YARD	39
30495	4"	55"	189.00	YARD		30711	23"	55"	169.00	YARD	33
30509		54"	99.80	YARD	5	30717	6 1/2"	55"	159.00	YARD	31
30511	18"	54"	99.00	YARD	16	30718	9 1/2"	1/2"	244.00	YARD	52
30512	3 1/2"	54"	85.00	YARD	14	30723	14 1/2"	55"	145.00	YARD	33
30514	4"	54"	79.00	YARD	19	30732		53"	248.00	YARD	34
30517	31"	54"	370.00	YARD	82	30735	6"	54"	189.00	YARD	27
30520	26"	53"	99.00	YARD	9	30739	30"	55"	264.00	YARD	44
30527	1"	56"	89.80	YARD	7	30740		53"	199.00	YARD	28

Prices herein quoted are suggested retail. Prices are subject to change without notice. All shipping and special processing charges are additional.

US Retail Price List - August 2016

Pattern	Repeat	Width	Price	UOM	Grade	Pattern	Repeat	Width	Price	UOM	Grade	
30741	1	1/2"	53"	199.00	YARD	34 30853	2"	54"	57.00	YARD	9	
30744			55"	89.80	YARD	21 30854		54"	59.80	YARD	13	
30745			57"	69.80	YARD	30856		54"	67.90	YARD	15	
30746			53"	59.00	YARD	30859		54"	55.00	YARD	10	
30751	31	1/2"	55"	316.00	YARD	57 30867	15"	54"	98.90	YARD	26	
30752	14	1/2"	53"	356.00	YARD	76 30870		55"	57.50	YARD	14	
30753			59"	45.00	YARD	9 30871		54"	45.00	YARD	9	
30757			54"	55.90	YARD	8 30872		54"	35.00	YARD	6	
30758	2"		54"	65.00	YARD	12 30873		55"	35.00	YARD	9	
30759			54"	59.00	YARD	11 30874	7 1/2"	49"	55.00	YARD	11	
30760	1"	1/4"	69.00	YARD	15 30881	22 1/2"	46"	67.90	YARD	32		
30764			54"	119.00	YARD	17 30883		54"	59.80	YARD	13	
30765			54"	99.00	YARD	12 30886		54"	49.80	YARD	9	
30766	18	1/2"	54"	125.00	YARD	5 30889	6"	54"	55.90	YARD	12	
30767		3"	54"	85.00	YARD	14 30890		54"	47.90	YARD	9	
30773		28"	1/2"	99.00	YARD	19 30898	9"	51"	59.00	YARD	13	
30774		14"	54"	119.00	YARD	17 30903	13"	51"	79.00	YARD		
30775	1	1/2"	54"	89.80	YARD	10 30905		54"	49.50	YARD	11	
30776		4"	54"	99.00	YARD	13 30910		54"	61.90	YARD	14	
30777		7"	58"	119.00	YARD	18 30917		54"	39.90	YARD	9	
30778			54"	59.80	YARD	8 30918		55"	51.90	YARD	10	
30779		13"	55"	117.00	YARD	17 30919	13 1/2"	55"	59.90	YARD	16	
30780	17	1/2"	54"	129.00	YARD	5 30926	4 1/2"	54"	41.90	YARD	9	
30782		1"	54"	99.80	YARD	17 30928	4 1/2"	54"	85.00	YARD	21	
30783		2"	54"	99.80	YARD	18 30930		55"	53.90	YARD	15	
30785		5"	54"	119.00	YARD	16 30932		57"	34.90	YARD	6	
30786	7	1/2"	55"	177.00	YARD	25 30936		52"	169.00	YARD		
30787			55"	148.00	YARD	22 30937	19 1/2"	54"	129.00	YARD	18	
30788		8"	1/2"	107.00	YARD	20 30942	15 1/2"	53"	159.00	YARD	32	
30791		10"	55"	97.00	YARD	16 30943		50"	139.00	YARD	18	
30794		6"	1/2"	99.80	YARD	18 30944		54"	115.00	YARD	13	
30795		5"	54"	97.00	YARD	18 30945		11"	1/2"	129.00	YARD	21
30798		3"	52"	85.00	YARD	15 30946	29 1/2"	55"	197.00	YARD	31	
30800	2	1/2"	54"	99.80	YARD	17 30948	5 1/2"	54"	99.00	YARD	17	
30802		14"	55"	115.00	YARD	5 30949		54"	75.00	YARD	12	
30804	11	1/2"	57"	59.80	YARD	10 30951		54"	49.80	YARD	8	
30808			54"	47.90	YARD	9 30953		55"	119.00	YARD	13	
30810			54"	59.00	YARD	10 30954		5"	1/2"	109.00	YARD	5
30811			54"	55.90	YARD	13 30957		10"	56"	99.80	YARD	13
30814			54"	97.00	YARD	9 30958	12 1/2"	1/2"	220.00	YARD		
30815			54"	41.90	YARD	14 30961		4"	1/2"	77.00	YARD	5
30816			54"	85.00	YARD	20 30962		4"	55"	69.80	YARD	5
30817			54"	85.00	YARD	23 30966		54"	55.90	YARD	11	
30818		8"	52"	99.00	YARD	13 30967		54"	84.90	YARD	19	
30827			54"	177.00	YARD	21 30968		57"	89.00	YARD	20	
30828			53"	248.00	YARD	35 30969		1/2"	69.80	YARD	5	
30829			54"	169.00	YARD	20 30974	23 1/2"	54"	324.00	YARD	52	
30830			54"	119.00	YARD	20 30977		54"	79.80	YARD	13	
30831			54"	159.00	YARD	19 30978	1 1/2"	55"	199.00	YARD	19	
30832			54"	99.00	YARD	14 30979		54"	79.80	YARD	13	
30834			54"	220.00	YARD	27 30980		54"	51.50	YARD	11	
30835			54"	99.00	YARD	19 30981		54"	99.00	YARD	10	
30837			54"	59.80	YARD	14 30983		54"	89.90	YARD	25	
30838			54"	59.00	YARD	11 30984		54"	69.00	YARD	21	
30839			54"	56.90	YARD	11 30985		17"	54"	244.00	YARD	32
30840			54"	49.90	YARD	9 30987	2 1/2"	54"	220.00	YARD	30	
30842			54"	59.00	YARD	11 30988		1"	54"	199.00	YARD	23
30844			54"	59.00	YARD	17 30990	3 1/2"	54"	149.00	YARD	23	
30845	7	1/2"	54"	97.00	YARD	14 30992		54"	69.00	YARD	5	
30846		1"	57"	55.00	YARD	13 30994		3"	53"	149.00	YARD	18
30848		2"	54"	149.00	YARD	19 30997		17"	55"	169.00	YARD	21
30849			54"	69.80	YARD	12 30998		54"	149.00	YARD	19	
30850	26	1/2"	54"	129.00	YARD	21 31003		55"	199.00	YARD	22	

Prices herein quoted are suggested retail. Prices are subject to change without notice. All shipping and special processing charges are additional.

US Retail Price List - August 2016

Pattern	Repeat	Width	Price	UOM	Grade	Pattern	Repeat	Width	Price	UOM	Grade
31005		54"	296.00	YARD	38	31131		53"	220.00	YARD	31
31007		55"	139.00	YARD	22	31132	2 5/8"	58"	69.00	YARD	5
31008		55"	79.80	YARD	11	31133	4 5/8"	55"	79.00	YARD	5
31010	7"	55"	85.00	YARD	15	31134		58"	79.80	YARD	5
31012		55"	316.00	YARD	35	31135		58"	79.80	YARD	5
31014		54"	149.00	YARD	13	31136		54"	47.90	YARD	5
31016	15"	54"	99.80	YARD	15	31137	1 1/2"	54"	97.00	YARD	5
31020	11"	55"	149.00	YARD	20	31138	2"	54"	125.00	YARD	5
31021	4"	54"	159.00	YARD	19	31141		55"	169.00	YARD	21
31022	7"	56"	55.00	YARD	12	31142		53"	290.00	YARD	34
31023	5 1/2"	56"	79.00	YARD	14	31146		54"	99.80	YARD	5
31024	2"	56"	159.00	YARD	23	31147	13"	54"	99.00	YARD	5
31027		56"	99.00	YARD	22	31148		54"	55.00	YARD	5
31028	4"	58"	89.00	YARD	16	31150		54"	53.00	YARD	5
31029		56"	85.00	YARD	14	31151		54"	45.00	YARD	5
31030		58"	99.80	YARD	18	31154		54"	59.80	YARD	5
31032	13 1/2"	54"	149.00	YARD	28	31155	4 1/2"	54"	79.80	YARD	5
31033	12"	54"	99.80	YARD	13	31156		53"	264.00	YARD	33
31034		54"	139.00	YARD	20	31157	3"	54"	99.80	YARD	5
31035	2 1/2"	54"	139.00	YARD	18	31160	2 1/2"	54"	117.00	YARD	5
31036	5"	54"	149.00	YARD	21	31161		54"	69.80	YARD	5
31037	3"	54"	139.00	YARD	16	31162	3"	54"	69.80	YARD	5
31038	7"	54"	149.00	YARD	21	31163	6"	54"	109.00	YARD	5
31042	14"	56"	97.00	YARD	20	31164		54"	69.90	YARD	5
31043	26"	55"	119.00	YARD	15	31166		55"	189.00	YARD	20
31044	7"	55"	169.00	YARD	23	31167		56"	59.80	YARD	5
31045		58"	89.00	YARD	17	31168	2" 1/2"	54"	99.80	YARD	5
31046		52"	89.80	YARD	17	31171	1/2"	54"	139.00	YARD	15
31047		55"	119.00	YARD	13	31172	3"	54"	99.80	YARD	5
31048	1"	56"	159.00	YARD	21	31176	1"	54"	149.00	YARD	21
31049	27"	54"	149.00	YARD	28	31177	11 1/2"	54"	99.80	YARD	15
31052	7"	53"	129.00	YARD	16	31178		55"	99.80	YARD	15
31053	5 1/2"	54"	119.00	YARD	5	31180	13"	57"	149.00	YARD	20
31056	2 1/2"	55"	139.00	YARD	16	31181	14"	56"	129.00	YARD	18
31057	13"	55"	129.00	YARD	19	31182	3 1/2"	57"	149.00	YARD	24
31062	13"	55"	149.00	YARD	25	31184	13 1/2"	55"	169.00	YARD	19
31071	15 1/2"	51"	264.00	YARD	43	31185	13"	55"	149.00	YARD	26
31078	4"	54"	149.00	YARD	20	31188	9 1/2"	54"	99.80	YARD	5
31079	5 1/2"	52"	264.00	YARD		31189	14"	54"	99.80	YARD	5
31081		54"	139.00	YARD	20	31191		55"	129.00	YARD	16
31085	15 1/2"	54"	248.00	YARD	44	31194		55"	199.00	YARD	22
31099		54"	31.90	YARD	6	31195		55"	236.00	YARD	27
31100		56"	39.80	YARD	10	31196		55"	149.00	YARD	17
31101	3"	54"	31.90	YARD	7	31197		55"	195.00	YARD	20
31102	5"	54"	99.80	YARD	5	31198		55"	248.00	YARD	29
31103	7"	54"	99.80	YARD	5	31200	2 1/2"	54"	149.00	YARD	21
31105	2"	54"	99.80	YARD	5	31202	1"	55"	199.00	YARD	32
31106	2"	54"	99.80	YARD	5	31205	5 1/2"	54"	149.00	YARD	29
31107		56"	49.80	YARD	5	31207		1/2"	99.80	YARD	5
31108		56"	75.90	YARD	5	31208		1/2"	59.80	YARD	5
31110		62"	59.80	YARD	5	31210	1"	54"	69.80	YARD	7
31111	2"	55"	99.80	YARD	5	31211	3"	54"	155.00	YARD	21
31112		54"	99.00	YARD	5	31212	4 1/2"	54"	169.00	YARD	20
31113	3 1/2"	54"	99.80	YARD	5	31213		56"	49.80	YARD	5
31114	13 3/4"	54"	95.00	YARD	5	31214		54"	59.80	YARD	5
31117		54"	37.90	YARD	8	31215		54"	99.00	YARD	37
31120		52"	197.00	YARD	29	31217		54"	89.80	YARD	13
31121	15 1/2"	48"	530.00	YARD	104	31219	2 1/2"	54"	99.80	YARD	5
31123	7 1/2"	55"	189.00	YARD	23	31222	11 1/2"	55"	197.00	YARD	28
31124		54"	33.90	YARD	9	31225	18"	53"	129.00	YARD	
31126		54"	29.00	YARD	11	31226	28 1/2"	57"	119.00	YARD	24
31127		52"	169.00	YARD	21	31231	5"	59"	129.00	YARD	15
31130		53"	199.00	YARD	28	31233	17 1/2"	55"	336.00	YARD	51

Prices herein quoted are suggested retail. Prices are subject to change without notice. All shipping and special processing charges are additional.

US Retail Price List - August 2016

Pattern	Repeat	Width	Price	UOM	Grade	Pattern	Repeat	Width	Price	UOM	Grade	
31235		54"	79.00	YARD	8	31372	14"	54"	149.00	YARD	20	
31236	19 1/2"	54"	284.00	YARD	46	31373		58"	149.00	YARD	16	
31240		7"	43.00	YARD	8	31374		1/2"	139.00	YARD	17	
31241	13 1/2"	54"	38.50	YARD	9	31375		55"	139.00	YARD	20	
31242		53"	199.00	YARD	26	31376		1/2"	149.00	YARD	21	
31244		53"	139.00	YARD	26	31377	13 1/2"	1/2"	179.00	YARD	24	
31245		53"	256.00	YARD	35	31380		9"	58"	149.00	YARD	23
31249		54"	58.90	YARD	14	31381		11"	1/2"	129.00	YARD	16
31250		54"	47.00	YARD	11	31382		16"	56"	139.00	YARD	19
31252		54"	47.00	YARD	12	31383		1/2"	109.00	YARD	13	
31253	9"	54"	58.50	YARD	12	31384	6 1/2"	1/2"	129.00	YARD	16	
31257		54"	220.00	YARD	26	31385		1"	55"	159.00	YARD	20
31259		54"	390.00	YARD	47	31387		14"	1/2"	109.00	YARD	18
31263		54"	348.00	YARD	46	31388		4"	57"	119.00	YARD	15
31265		54"	296.00	YARD	38	31389		2"	1/2"	119.00	YARD	17
31266	15 1/2"	54"	290.00	YARD	42	31390		4"	51"	149.00	YARD	21
31267		55"	41.90	YARD	14	31391		56"	79.80	YARD	18	
31268		54"	139.00	YARD	13	31392	13 1/2"	56"	119.00	YARD	17	
31269		55"	45.90	YARD	11	31393	13 3/4"	1/2"	149.00	YARD	26	
31270		57"	67.00	YARD	11	31395		15"	55"	149.00	YARD	21
31272	14"	54"	336.00	YARD	50	31396		49"	149.00	YARD	20	
31274	4 1/2"	54"	396.00	YARD	70	31397		58"	97.00	YARD	11	
31275		1/2"	199.00	YARD	32	31399		7"	56"	99.00	YARD	13
31289		1"	125.00	YARD	5	31400		55"	119.00	YARD	14	
31297	13 1/2"	54"	199.00	YARD	27	31401		53"	159.00	YARD	20	
31298		55"	198.00	YARD	37	31402	18"	54"	149.00	YARD	22	
31307	10"	54"	199.00	YARD	27	31403		1/2"	119.00	YARD	14	
31311		54"	197.00	YARD	24	31404		2"	54"	159.00	YARD	20
31313	5"	54"	248.00	YARD	42	31405	16 1/4"	58"	115.00	YARD	16	
31314	5"	48"	248.00	YARD	37	31406		3"	1/2"	129.00	YARD	16
31317	27"	54"	99.80	YARD	16	31407		2"	53"	129.00	YARD	19
31320		54"	195.00	YARD	25	31408	14 1/2"	1/2"	149.00	YARD	22	
31321	14"	54"	169.00	YARD	26	31409		57"	97.00	YARD	12	
31322	7"	54"	228.00	YARD	32	31410		13"	1/2"	159.00	YARD	24
31323	7"	54"	316.00	YARD	47	31411		54"	75.00	YARD	13	
31324	28"	54"	189.00	YARD	35	31412		6"	1/2"	99.00	YARD	14
31325	2"	54"	197.00	YARD	34	31414	28"	1/2"	139.00	YARD	25	
31326		54"	99.80	YARD	16	31415		54"	95.00	YARD	10	
31327	49 1/2"	54"	296.00	YARD	48	31416		7"	1/2"	99.80	YARD	15
31328		54"	179.00	YARD	28	31417		7"	54"	119.00	YARD	19
31331		54"	59.80	YARD	5	31418		10"	57"	139.00	YARD	16
31333	1"	54"	139.00	YARD	21	31419		7"	1/2"	149.00	YARD	18
31334	16"	54"	119.00	YARD		31420	16 1/2"	58"	99.00	YARD	16	
31337	5"	54"	149.00	YARD	21	31421		14"	55"	169.00	YARD	25
31339	11"	54"	159.00	YARD	27	31422	5 1/2"	1/2"	149.00	YARD	22	
31340		53"	87.90	YARD	17	31424		59"	119.00	YARD	14	
31341	39 1/2"	54"	276.00	YARD	52	31426		52"	179.00	YARD	21	
31343		53"	139.00	YARD	33	31427		57"	99.80	YARD	11	
31344		53"	129.00	YARD	29	31428		1/2"	99.00	YARD	14	
31345		53"	149.00	YARD	26	31429	7"	1/2"	149.00	YARD	18	
31346		54"	119.00	YARD	19	31430		54"	89.80	YARD	9	
31352		55"	165.00	YARD	32	31433		54"	189.00	YARD		
31354		53"	109.00	YARD	21	31435		54"	159.00	YARD	21	
31359		53"	149.00	YARD	29	31436		7"	58"	149.00	YARD	20
31360	13 1/2"	56"	129.00	YARD	20	31437	13 3/4"	1/2"	169.00	YARD	26	
31361	26"	1/2"	199.00	YARD	35	31438		57"	197.00	YARD		
31362		53"	145.00	YARD	24	31440		54"	149.00	YARD	24	
31365		51"	185.00	YARD	23	31442	17 1/2"	54"	99.00	YARD	17	
31367		1/2"	99.00	YARD	13	31444		27"	1/2"	149.00	YARD	23
31368	6"	56"	129.00	YARD	16	31445	13 1/2"	1/2"	129.00	YARD	19	
31369	14"	58"	99.00	YARD	16	31446	17 1/2"	1/2"	149.00	YARD	23	
31370	1"	1/2"	139.00	YARD	18	31449		31"	53"	216.00	YARD	49
31371	14 1/2"	1/2"	179.00	YARD	26	31451		4"	55"	248.00	YARD	29

Prices herein quoted are suggested retail. Prices are subject to change without notice. All shipping and special processing charges are additional.

US Retail Price List - August 2016

Pattern	Repeat	Width	Price	UOM	Grade	Pattern	Repeat	Width	Price	UOM	Grade
31452		53"	149.00	YARD	25	31535	6 1/2"	54"	119.00	YARD	21
31453	8 1/2"	54"	179.00	YARD	24	31541	6 1/2"	54"	137.00	YARD	20
31454		57"	244.00	YARD	32	31542	8"	1/2"	109.00	YARD	18
31456	10"	57"	316.00	YARD	47	31543	6"	55"	99.00	YARD	15
31457		55"	199.00	YARD	18	31544	4"	1/2"	97.00	YARD	14
31458	14"	53"	276.00	YARD	42	31545	2"	1/2"	99.80	YARD	17
31459	2 1/2"	51"	288.00	YARD	42	31546		1/2"	99.80	YARD	16
31460		54"	115.00	YARD	13	31547	13 1/2"	1/2"	109.00	YARD	21
31461		54"	175.00	YARD	30	31548	5"	54"	119.00	YARD	21
31463		55"	159.00	YARD	17	31549	2 1/2"	58"	99.00	YARD	19
31465		1/2"	236.00	YARD	25	31550		56"	99.80	YARD	15
31467	13 1/2"	55"	396.00	YARD	73	31551	14"	1/2"	119.00	YARD	22
31468		54"	264.00	YARD	37	31552	1 1/2"	55"	119.00	YARD	20
31469	1"	54"	298.00	YARD	35	31553	7 1/2"	1/2"	119.00	YARD	21
31471		55"	199.00	YARD	24	31555		54"	179.00	YARD	22
31472	4"	55"	236.00	YARD	28	31556		59"	99.80	YARD	16
31473		55"	189.00	YARD	24	31557	4"	55"	99.80	YARD	16
31474		53"	396.00	YARD	78	31559	8 1/2"	1/2"	119.00	YARD	19
31475		53"	199.00	YARD	33	31565	1 1/2"	1/2"	99.80	YARD	18
31476		55"	179.00	YARD	21	31567	1 1/2"	54"	220.00	YARD	35
31478		55"	199.00	YARD	26	31568	38 1/2"	54"	197.00	YARD	28
31479	15 1/2"	53"	296.00	YARD	49	31569		56"	65.90	YARD	15
31482		54"	159.00	YARD	27	31571		55"	41.90	YARD	9
31483	1 1/2"	55"	264.00	YARD	44	31573	21"	54"	93.90	YARD	31
31485		54"	149.00	YARD	19	31575		54"	53.00	YARD	14
31487	7 1/2"	54"	199.00	YARD	28	31576	1 1/2"	54"	37.00	YARD	8
31489	29 1/2"	52"	356.00	YARD	86	31583	2 1/2"	54"	39.80	YARD	8
31491	15"	50"	197.00	YARD	36	31585		54"	37.00	YARD	7
31494		56"	43.90	YARD	9	31586		54"	47.00	YARD	11
31495	8"	52"	99.00	YARD	17	31590	4"	54"	55.00	YARD	12
31496	4 1/2"	54"	79.80	YARD	9	31591	3 1/2"	1/2"	55.00	YARD	12
31497	33"	54"	179.00	YARD	23	31592	15"	54"	113.00	YARD	35
31498		57"	59.00	YARD	6	31593		53"	47.00	YARD	11
31499		53"	99.80	YARD	14	31594	2"	53"	64.90	YARD	15
31500	14"	57"	97.00	YARD	10	31595		55"	59.90	YARD	14
31502		54"	57.00	YARD	5	31596	1"	57"	54.90	YARD	11
31503	15 1/2"	54"	199.00	YARD	35	31598		54"	59.80	YARD	13
31504	6"	54"	197.00	YARD	29	31600	9"	54"	85.00	YARD	21
31507		54"	54.90	YARD	5	31602		55"	73.80	YARD	14
31509		53"	264.00	YARD	30	31603		54"	69.90	YARD	16
31511	6"	53"	264.00	YARD	38	31604		54"	48.90	YARD	12
31512		54"	59.00	YARD	5	31605		55"	79.90	YARD	25
31513	4" 1/2"	99.80	YARD	17	31606		55"	59.80	YARD	18	
31514	1/2"	99.80	YARD	15	31607		1/2"	41.80	YARD	9	
31516		54"	99.80	YARD	14	31610	15"	54"	85.00	YARD	28
31517		55"	89.00	YARD	9	31611		53"	117.00	YARD	20
31518	6 1/2"	1/2"	109.00	YARD	18	31614		54"	59.80	YARD	14
31519	3 1/2"	1/2"	87.00	YARD	14	31616		56"	75.00	YARD	17
31520	10"	55"	89.80	YARD	15	31618	2"	54"	41.90	YARD	11
31521	22" 1/2"	296.00	YARD	52	31620		54"	65.00	YARD	16	
31522	5"	55"	109.00	YARD	18	31621		54"	53.90	YARD	12
31523	20 1/2"	59"	97.00	YARD	16	31623		54"	89.90	YARD	
31524	10"	54"	129.00	YARD	20	31624	4 1/2"	56"	61.00	YARD	16
31525	3"	55"	99.00	YARD	18	31625		55"	53.90	YARD	13
31526	5"	55"	99.80	YARD	17	31626		55"	53.90	YARD	15
31527	6" 1/2"	99.80	YARD	17	31627		55"	59.90	YARD	15	
31528		57"	119.00	YARD	17	31629		56"	49.80	YARD	16
31529		55"	99.80	YARD	15	31634		55"	55.00	YARD	12
31530		1/2"	99.80	YARD	14	31640	16"	54"	85.00	YARD	20
31531		54"	129.00	YARD		31641		60"	51.90	YARD	10
31532	14"	55"	79.80	YARD	17	31643		54"	67.90	YARD	15
31533		54"	87.00	YARD	12	31644	9"	51"	79.90	YARD	26
31534	3 1/2"	54"	99.80	YARD	17	31645	5"	48"	159.00	YARD	

Prices herein quoted are suggested retail. Prices are subject to change without notice. All shipping and special processing charges are additional.

US Retail Price List - August 2016

Pattern	Repeat	Width	Price	UOM	Grade	Pattern	Repeat	Width	Price	UOM	Grade
31646	2 1/2"	49"	149.00	YARD		31760		54"	99.80	YARD	5
31647		4" 49"	149.00	YARD	26	31761		54"	97.00	YARD	5
31648		54"	41.90	YARD	11	31762		54"	87.00	YARD	5
31649		54"	43.00	YARD	11	31763		54"	99.00	YARD	5
31650		54"	41.90	YARD	8	31765		54"	149.00	YARD	20
31651		54"	46.90	YARD	15	31768	5"	54"	137.00	YARD	
31653		54"	56.90	YARD	15	31771		1/2"	59.00	YARD	12
31656		56"	49.90	YARD	11	31772		54"	115.00	YARD	15
31659		54"	51.90	YARD	13	31773	5"	54"	149.00	YARD	18
31661	9"	54"	73.80	YARD	17	31774	6 1/2"	124"	159.00	YARD	21
31665	8"	54"	51.90	YARD	14	31775	7"	55"	149.00	YARD	19
31668		54"	67.90	YARD	16	31776		54"	99.00	YARD	13
31671		54"	49.00	YARD	12	31777		54"	115.00	YARD	15
31679	6"	51"	115.00	YARD	33	31778	13 1/2"	54"	149.00	YARD	26
31681		55"	63.00	YARD	14	31779		54"	99.00	YARD	14
31682		56"	68.50	YARD	5	31782		54"	159.00	YARD	21
31683	9"	52"	109.80	YARD	35	31783	2"	54"	179.00	YARD	26
31684		55"	41.90	YARD	8	31784		54"	129.00	YARD	18
31685	3"	52"	113.00	YARD	28	31785		54"	89.80	YARD	15
31687	8 1/2"	50"	57.90	YARD		31786		54"	79.80	YARD	15
31688		55"	41.90	YARD	10	31788		60"	99.80	YARD	15
31689		56"	39.90	YARD	8	31789		54"	115.00	YARD	17
31690	5 1/2"	54"	316.00	YARD	49	31790	8"	54"	199.00	YARD	37
31694	27 1/2"	55"	248.00	YARD	39	31791	7 1/2"	54"	139.00	YARD	17
31695	3"	54"	199.00	YARD	27	31792	12 1/2"	54"	199.00	YARD	29
31696	23"	54"	199.00	YARD	32	31793	2"	54"	139.00	YARD	18
31698	27 1/2"	54"	199.00	YARD	36	31794	7 1/2"	54"	197.00	YARD	29
31701	9 1/2"	54"	149.00	YARD	21	31796	1 1/2"	54"	220.00	YARD	31
31703		55"	119.00	YARD	12	31797	7"	54"	169.00	YARD	24
31704		54"	159.00	YARD	23	31798		54"	179.00	YARD	24
31708	6 1/2"	54"	177.00	YARD	24	31799	7"	54"	149.00	YARD	24
31710		54"	49.90	YARD	11	31801		54"	189.00	YARD	26
31711		54"	59.00	YARD	13	31803		54"	169.00	YARD	20
31712		54"	69.00	YARD	12	31804		54"	179.00	YARD	27
31713		54"	61.90	YARD	12	31805	3"	54"	199.00	YARD	31
31716	1/2"	197.00	YARD	27	31806		54"	159.00	YARD	21	
31717		54"	79.80	YARD	15	31807		54"	61.90	YARD	12
31722		54"	129.00	YARD	19	31808		54"	220.00	YARD	33
31724		54"	179.00	YARD	23	31809		54"	69.80	YARD	14
31725	4 1/2"	54"	199.00	YARD	29	31811	5"	54"	137.00	YARD	22
31726	6 1/2"	54"	199.00	YARD	29	31814		57"	199.00	YARD	31
31727	7"	54"	199.00	YARD	29	31815	8"	54"	197.00	YARD	31
31729		54"	89.80	YARD	17	31816		55"	199.00	YARD	25
31731		54"	61.90	YARD	12	31817		54"	119.00	YARD	17
31732		54"	69.00	YARD	14	31818		54"	149.00	YARD	16
31734		50"	149.00	YARD	21	31819	53"	55"	189.00	YARD	41
31735		54"	169.00	YARD	20	31820		54"	29.00	YARD	11
31741		54"	45.90	YARD	11	31822		54"	33.90	YARD	9
31742	3 1/2"	54"	115.00	YARD	5	31823		54"	37.90	YARD	8
31743		54"	99.00	YARD	5	31825		54"	27.90	YARD	5
31744	5 5/8"	54"	99.00	YARD	5	31827		56"	69.00	YARD	8
31745		54"	87.00	YARD	5	31828		55"	69.00	YARD	9
31746		54"	109.00	YARD	5	31829		55"	248.00	YARD	31
31747		54"	99.00	YARD	5	31830		55"	189.00	YARD	20
31748	2"	54"	99.00	YARD	5	31831		53"	99.00	YARD	
31750		54"	99.80	YARD	5	31832		55"	195.00	YARD	24
31752		54"	97.00	YARD	5	31833	12"	54"	85.00	YARD	15
31754		54"	87.00	YARD	5	31834	6 1/2"	54"	79.80	YARD	9
31755		54"	99.80	YARD	5	31835		59"	199.00	YARD	28
31756		54"	97.00	YARD	5	31837		55"	199.00	YARD	25
31757		54"	79.00	YARD	5	31838	28"	55"	197.00	YARD	31
31758		54"	79.80	YARD	5	31839		57"	236.00	YARD	28
31759	3"	54"	99.00	YARD	5	31841	2 1/2"	54"	69.00	YARD	8

Prices herein quoted are suggested retail. Prices are subject to change without notice. All shipping and special processing charges are additional.

US Retail Price List - August 2016

Pattern	Repeat	Width	Price	UOM	Grade	Pattern	Repeat	Width	Price	UOM	Grade
31842		53"	129.00	YARD	23	31939		54"	220.00	YARD	29
31843	1 1/2"	51"	149.00	YARD		31940	10"	53"	169.00	YARD	28
31844		50"	159.00	YARD	37	31941	14"	54"	199.00	YARD	30
31847		54"	139.00	YARD	31	31942	8"	54"	220.00	YARD	30
31849		54"	159.00	YARD	31	31943	7 1/2"	54"	220.00	YARD	32
31850		54"	169.00	YARD	35	31944	8"	54"	179.00	YARD	26
31851		54"	139.00	YARD	24	31948	1 1/2"	52"	264.00	YARD	49
31852		1/2"	248.00	YARD	44	31949	6"	54"	179.00	YARD	22
31853		55"	169.00	YARD	19	31951	12"	54"	189.00	YARD	28
31854		54"	63.90	YARD	15	31952	22"	54"	236.00	YARD	40
31855		54"	63.90	YARD	13	31953		50"	236.00	YARD	32
31857		54"	57.00	YARD	12	31954		54"	149.00	YARD	19
31858	7"	54"	75.00	YARD	12	31955		56"	149.00	YARD	19
31859		53"	199.00	YARD	35	31956	8"	54"	198.90	YARD	30
31860		54"	63.90	YARD	13	31957	2"	54"	149.00	YARD	21
31861		54"	63.90	YARD	13	31958	7 1/2"	54"	99.80	YARD	16
31864		54"	63.90	YARD	13	31961	2 1/2"	54"	99.80	YARD	15
31866	19"	52"	129.00	YARD	22	31963		57"	119.00	YARD	19
31867		54"	99.80	YARD	16	31964		58"	109.00	YARD	16
31868		54"	99.00	YARD	17	31965		59"	59.00	YARD	12
31870		54"	139.00	YARD	17	31966	26"	1/2"	129.00	YARD	22
31871		55"	99.00	YARD	17	31967	13 1/2"	54"	119.00	YARD	17
31872	1"	57"	86.50	YARD	20	31968	28"	54"	149.00	YARD	25
31873	7"	54"	109.00	YARD	17	31969	14"	54"	264.00	YARD	41
31874		54"	87.00	YARD	5	31970		57"	49.80	YARD	7
31875		54"	119.00	YARD	19	31972	2"	53"	75.00	YARD	
31877		54"	129.00	YARD	20	31973	11"	54"	220.00	YARD	32
31878		1/2"	79.80	YARD	12	31974	26 1/2"	55"	99.80	YARD	19
31879		57"	149.00	YARD	14	31975	6"	1/2"	149.00	YARD	27
31880		53"	97.00	YARD	12	31977		53"	258.00	YARD	44
31881	15 1/2"	55"	149.00	YARD	22	31978		1/2"	149.00	YARD	21
31882	7"	55"	159.00	YARD	21	31979		54"	129.00	YARD	15
31883		55"	79.80	YARD	11	31980	2"	54"	169.00	YARD	23
31885	11"	52"	149.00	YARD	29	31981	14 1/2"	1/2"	149.00	YARD	22
31886	9"	52"	149.00	YARD	28	31982	4"	57"	149.00	YARD	20
31888		55"	59.90	YARD	14	31983	13"	1/2"	139.00	YARD	21
31889		54"	79.00	YARD	9	31985	7"	54"	139.00	YARD	20
31890	17"	53"	99.00	YARD	20	31987		54"	129.00	YARD	16
31892		54"	79.00	YARD	10	31988	4"	53"	248.00	YARD	42
31893	16 1/2"	54"	99.00	YARD	19	31990	6 1/2"	55"	179.00	YARD	20
31894	20"	54"	159.00	YARD	29	31991		54"	69.00	YARD	13
31896		55"	75.00	YARD	15	31992		58"	99.00	YARD	5
31897	8"	55"	119.00	YARD	20	31993	4 1/2"	1/2"	149.00	YARD	25
31899		54"	119.00	YARD	15	31998	39"	56"	149.00	YARD	26
31900		55"	139.00	YARD	21	31999		58"	99.80	YARD	18
31902		54"	99.00	YARD	11	32001		55"	79.90	YARD	19
31903	25"	54"	139.00	YARD	24	32002		54"	149.90	YARD	22
31904	27"	57"	119.00	YARD	21	32003		58"	99.00	YARD	12
31907	30 1/2"	56"	149.00	YARD	24	32004		54"	175.00	YARD	26
31910	13 1/2"	54"	99.00	YARD	16	32005		54"	89.90	YARD	25
31915	13 1/2"	54"	99.00	YARD	17	32006		54"	93.90	YARD	25
31917		54"	99.00	YARD	18	32007		55"	59.90	YARD	14
31920		54"	119.00	YARD	20	32008		54"	99.80	YARD	24
31923		54"	137.00	YARD	18	32009	3"	55"	58.90	YARD	12
31924		54"	85.00	YARD	17	32011	3"	54"	155.00	YARD	23
31925	27"	54"	79.00	YARD	15	32012	4"	58"	89.00	YARD	16
31926		54"	139.00	YARD	19	32013	14"	56"	99.00	YARD	12
31930	13 1/2"	54"	159.00	YARD	25	32014	12 1/2"	52"	159.00	YARD	30
31932	14 1/2"	54"	99.00	YARD	13	32015		54"	99.00	YARD	13
31934		56"	149.00	YARD	26	32016		54"	99.00	YARD	14
31935		54"	149.00	YARD	19	32017		54"	119.00	YARD	24
31937	7"	54"	159.00	YARD	24	32018	2"	54"	99.00	YARD	12
31938		53"	236.00	YARD	35	32019	16"	54"	236.00	YARD	38

Prices herein quoted are suggested retail. Prices are subject to change without notice. All shipping and special processing charges are additional.

US Retail Price List - August 2016

Pattern	Repeat	Width	Price	UOM	Grade	Pattern	Repeat	Width	Price	UOM	Grade
32020		54"	99.00	YARD	5	32116	28 1/2"	55"	270.00	YARD	38
32021		54"	109.00	YARD	19	32118	1"	54"	348.00	YARD	46
32022		54"	87.00	YARD	5	32119		51"	396.00	YARD	44
32023	5 5/8"	54"	99.00	YARD	17	32122	14"	55"	169.00	YARD	22
32024	3 1/2"	54"	115.00	YARD	5	32128		55"	75.00	YARD	10
32025		54"	97.00	YARD	12	32129	5"	1 1/2"	99.00	YARD	15
32026		54"	87.00	YARD	5	32130	7"	54"	79.80	YARD	9
32027		54"	97.00	YARD	13	32131	5"	52"	125.00	YARD	18
32028		54"	99.80	YARD	13	32134	10"	54"	149.00	YARD	17
32029		54"	99.00	YARD	11	32140	10"	54"	149.00	YARD	25
32030		54"	87.00	YARD	10	32141	1 1/2"	54"	119.00	YARD	16
32031		54"	99.80	YARD	5	32143	11"	54"	129.00	YARD	20
32032		54"	97.00	YARD	5	32144	4"	54"	159.00	YARD	22
32033		54"	79.00	YARD	5	32145	15"	54"	159.00	YARD	27
32034		54"	79.80	YARD	5	32146	6"	54"	99.80	YARD	15
32035		55"	75.00	YARD	10	32147		55"	256.00	YARD	34
32037	13 1/2"	55"	149.00	YARD	22	32148		54"	59.90	YARD	15
32040	13"	56"	109.00	YARD	19	32149	5"	54"	115.00	YARD	18
32041	12 1/2"	55"	199.00	YARD		32150	4 1/2"	54"	129.00	YARD	19
32043	19"	54"	149.00	YARD	22	32151	6"	58"	99.00	YARD	15
32046		55"	248.00	YARD		32154	13"	1 1/2"	129.00	YARD	18
32048		55"	264.00	YARD	44	32155	8"	1 1/2"	139.00	YARD	19
32051	24"	53"	244.00	YARD	47	32156	2"	53"	149.00	YARD	20
32052	26 1/2"	53"	236.00	YARD	45	32157	14"	1 1/2"	119.00	YARD	20
32055	6"	55"	177.00	YARD	23	32158	9 1/2"	50"	129.00	YARD	19
32057	19 1/2"	55"	169.00	YARD		32159	18 1/2"	54"	99.00	YARD	18
32059	24"	55"	316.00	YARD	50	32160		56"	129.00	YARD	26
32060	7 1/2"	55"	197.00	YARD	25	32161	8 1/2"	57"	129.00	YARD	17
32061	14"	52"	197.00	YARD	36	32162	9 1/2"	56"	129.00	YARD	19
32062		55"	248.00	YARD	29	32164	13 1/2"	54"	197.00	YARD	24
32063		55"	189.00	YARD	20	32165	13 1/2"	54"	197.00	YARD	24
32065		43"	199.00	YARD	32	32166	13 1/2"	54"	197.00	YARD	24
32068		55"	129.00	YARD	14	32167		56"	169.00	YARD	
32069		55"	119.00	YARD	15	32170		54"	159.00	YARD	
32071		53"	129.00	YARD	26	32171	3"	54"	169.00	YARD	21
32072		55"	356.00	YARD	49	32173	15 1/2"	52"	199.00	YARD	
32073		55"	139.00	YARD	14	32174	27 1/2"	54"	330.00	YARD	56
32075		55"	199.00	YARD	26	32175	13"	52"	370.00	YARD	58
32076	15 1/2"	51"	298.00	YARD		32176	1"	54"	55.00	YARD	8
32077		55"	290.00	YARD	26	32177	6 1/2"	54"	49.80	YARD	11
32078	6"	55"	189.00	YARD	22	32178	4"	54"	75.00	YARD	18
32081	17"	54"	169.00	YARD	31	32180	20"	54"	75.00	YARD	11
32083		53"	99.80	YARD	14	32181	18"	54"	67.00	YARD	12
32087		53"	97.00	YARD	12	32182	3"	54"	67.00	YARD	9
32089	10"	54"	256.00	YARD	36	32183	13 1/2"	54"	77.00	YARD	12
32090		55"	149.00	YARD	20	32184	1"	54"	67.00	YARD	10
32091		54"	175.00	YARD	30	32185	13 1/2"	54"	67.00	YARD	11
32092	10"	55"	396.00	YARD	46	32186		54"	62.50	YARD	18
32093		1 1/2"	197.00	YARD	26	32188	9"	51"	119.90	YARD	34
32095	3 1/2"	54"	189.00	YARD	23	32189	12 1/2"	52"	134.50	YARD	41
32096		53"	97.00	YARD	14	32191	1 1/2"	54"	105.90	YARD	29
32100	13 1/2"	54"	296.00	YARD	56	32194		54"	105.90	YARD	23
32101	4"	54"	248.00	YARD	33	32199	8"	54"	169.00	YARD	29
32102	17"	55"	290.00	YARD	48	32200	8"	52"	179.00	YARD	37
32103	30"	54"	264.00	YARD	38	32202	4 1/2"	55"	199.00	YARD	25
32105	14 1/2"	55"	336.00	YARD	71	32204		53"	139.00	YARD	23
32106	19"	53"	274.00	YARD	57	32205	3"	54"	179.00	YARD	21
32108	12"	54"	298.00	YARD	45	32206	3 1/2"	54"	396.00	YARD	52
32109	27"	53"	197.00	YARD	39	32207	27 1/2"	53"	270.00	YARD	46
32111	5 1/2"	1 1/2"	236.00	YARD	33	32208	8 1/2"	52"	149.00	YARD	29
32112		51"	256.00	YARD	37	32209	15"	51"	149.00	YARD	26
32113	30"	55"	189.00	YARD		32210		51"	139.00	YARD	23
32114		54"	256.00	YARD	26	32211	22"	1 1/2"	197.00	YARD	28

Prices herein quoted are suggested retail. Prices are subject to change without notice. All shipping and special processing charges are additional.

US Retail Price List - August 2016

Pattern	Repeat	Width	Price	UOM	Grade	Pattern	Repeat	Width	Price	UOM	Grade
32212	3 1/2"	54"	199.00	YARD	25	32298		54"	65.90	YARD	20
32213	20 1/2"	54"	189.00	YARD	28	32299		1/2"	41.90	YARD	15
32214		50"	256.00	YARD	41	32300		54"	27.50	YARD	11
32215	16 1/2"	54"	197.00	YARD		32301		53"	43.90	YARD	15
32216	16"	52"	248.00	YARD	38	32302		53"	41.90	YARD	11
32219	22 1/2"	54"	149.00	YARD	22	32303	1 1/2"	53"	119.00	YARD	21
32222	17"	54"	250.00	YARD	35	32304		55"	59.80	YARD	5
32223		54"	57.50	YARD	17	32305		54"	45.00	YARD	14
32224		54"	47.90	YARD	15	32306		54"	69.90	YARD	10
32229		56"	47.90	YARD	9	32307		54"	64.90	YARD	12
32230	1"	54"	91.00	YARD	23	32308		54"	45.00	YARD	10
32231		56"	43.00	YARD	10	32309		54"	49.00	YARD	15
32232		56"	43.00	YARD	9	32310		57"	41.50	YARD	15
32233		55"	79.90	YARD	23	32312	7"	54"	288.00	YARD	36
32234		54"	89.90	YARD	25	32314		55"	53.90	YARD	13
32236		55"	47.80	YARD	15	32315	15 1/2"	52"	270.00	YARD	48
32237		54"	39.90	YARD	8	32316	15 1/2"	51"	264.00	YARD	48
32240		54"	43.90	YARD	14	32317		54"	49.80	YARD	12
32241		54"	45.90	YARD	5	32319		54"	39.90	YARD	14
32242	13 1/2"	54"	67.00	YARD	11	32320		55"	41.90	YARD	15
32243	3"	54"	69.00	YARD	11	32322		58"	73.90	YARD	15
32244		55"	59.90	YARD	12	32324		58"	75.00	YARD	15
32245	7"	54"	69.00	YARD	11	32325		54"	51.90	YARD	16
32246		56"	41.90	YARD	14	32326		54"	97.00	YARD	22
32247	10"	54"	75.00	YARD	11	32328	2"	54"	189.00	YARD	24
32249		54"	45.90	YARD	11	32329		54"	59.90	YARD	18
32250	4 1/2"	54"	69.00	YARD	12	32330		54"	99.80	YARD	25
32251		54"	59.80	YARD	10	32333	4"	54"	248.00	YARD	29
32252		54"	53.90	YARD	17	32334	7 1/2"	54"	89.00	YARD	14
32253		54"	44.90	YARD	11	32335	6 1/2"	54"	199.00	YARD	
32254	30"	55"	117.00	YARD	17	32336	5 1/2"	54"	97.00	YARD	14
32255		55"	59.80	YARD	5	32337	11"	54"	189.00	YARD	
32256		54"	57.00	YARD	9	32338		58"	53.00	YARD	16
32257	29"	54"	199.00	YARD	33	32339		54"	37.50	YARD	13
32258		56"	56.90	YARD	18	32340		1/2"	51.80	YARD	16
32259		54"	55.00	YARD	10	32343	15 1/2"	51"	199.00	YARD	42
32260		54"	69.80	YARD	20	32344		54"	41.90	YARD	14
32261		54"	57.00	YARD	10	32345		54"	197.00	YARD	
32262	2 1/2"	54"	59.80	YARD	9	32346	10"	54"	284.00	YARD	41
32264	3"	54"	69.00	YARD	10	32347	26"	54"	284.00	YARD	44
32265	12"	54"	69.00	YARD	9	32348	10 1/2"	54"	284.00	YARD	36
32266	3 1/2"	54"	75.00	YARD	12	32349	9 1/2"	54"	197.00	YARD	29
32267	3 1/2"	54"	67.00	YARD	12	32350	14 1/2"	54"	248.00	YARD	33
32269		54"	45.00	YARD	9	32351		56"	46.90	YARD	11
32271	14 1/2"	54"	69.00	YARD	12	32352	13 1/2"	54"	290.00	YARD	
32274		54"	37.80	YARD	11	32353		54"	139.00	YARD	22
32275	3"	54"	59.80	YARD	10	32356	20 1/2"	54"	264.00	YARD	38
32276		54"	39.00	YARD	7	32357	20 1/2"	53"	270.00	YARD	45
32278		54"	39.90	YARD	8	32359	5 3/4"	1/2"	41.90	YARD	9
32282		55"	95.90	YARD	19	32360	15"	59"	35.90	YARD	10
32283		55"	95.90	YARD	19	32364		55"	220.00	YARD	26
32286		54"	37.90	YARD	7	32365		49"	47.90	YARD	18
32287		54"	37.90	YARD	12	32366		59"	39.90	YARD	13
32288		54"	59.80	YARD	17	32367		53"	199.00	YARD	34
32289		54"	37.00	YARD	12	32370		55"	177.00	YARD	
32290		54"	49.00	YARD	11	32371	26"	58"	189.00	YARD	33
32291		54"	37.00	YARD	12	32374	6"	57"	236.00	YARD	24
32292		54"	45.00	YARD	7	32375	52 1/2"	55"	149.00	YARD	
32293		54"	39.00	YARD	7	32376		55"	169.00	YARD	23
32294		54"	39.80	YARD	8	32377		55"	99.00	YARD	
32295		54"	39.00	YARD	8	32378	2 1/2"	55"	145.00	YARD	18
32296		54"	95.00	YARD	24	32384		55"	248.00	YARD	30
32297	1/2"	47.00	YARD	16	32393		55"	165.00	YARD	19	

Prices herein quoted are suggested retail. Prices are subject to change without notice. All shipping and special processing charges are additional.

US Retail Price List - August 2016

Pattern	Repeat	Width	Price	UOM	Grade	Pattern	Repeat	Width	Price	UOM	Grade	
32394		55"	145.00	YARD	22	32498		55"	65.00	YARD	7	
32395	82"	55"	169.00	YARD		32499	8"	56"	79.80	YARD	7	
32398		55"	197.00	YARD	23	32501		55"	59.90	YARD	14	
32401	8"	53"	199.00	YARD	30	32502	18"	55"	99.00	YARD	13	
32402	8"	54"	189.00	YARD		32503	10"	1/2"	179.00	YARD	27	
32405		1/2"	157.00	YARD	25	32504	12"	54"	99.00	YARD	14	
32407		55"	99.00	YARD	11	32505	3"	55"	58.90	YARD	7	
32408		55"	119.80	YARD	16	32506		55"	115.00	YARD	13	
32410	28 1/2"	54"	149.00	YARD	25	32507		53"	159.00	YARD	22	
32411	2 1/2"	55"	199.00	YARD	24	32511	18 1/2"	54"	197.00	YARD	31	
32415	12 1/2"	55"	189.00	YARD	17	32512		54"	57.50	YARD	13	
32416		55"	177.00	YARD	19	32513	2"	54"	57.00	YARD	11	
32418		54"	179.00	YARD	23	32514		55"	79.90	YARD	23	
32419		1/2"	159.00	YARD	18	32515	6 1/2"	55"	298.00	YARD	37	
32421		55"	198.00	YARD	37	32517		5"	54"	139.00	YARD	21
32422		55"	256.00	YARD	23	32518	18 1/2"	55"	149.60	YARD	22	
32426	28 1/2"	59"	129.00	YARD	23	32519		1/2"	115.00	YARD	13	
32427	1"	54"	248.00	YARD	33	32520	1 1/2"	56"	79.00	YARD	14	
32431		54"	179.00	YARD	21	32521	8 1/2"	58"	149.00	YARD	19	
32433	15"	1/2"	199.60	YARD	36	32522	4"	58"	129.00	YARD	16	
32434	23 1/2"	62"	236.00	YARD	28	32524		54"	89.00	YARD	6	
32436		54"	199.00	YARD	22	32525	4"	1/2"	177.00	YARD	21	
32437	17 7/8"	1/2"	248.00	YARD	48	32526	12"	56"	149.00	YARD	18	
32438	14 1/2"	54"	256.00	YARD	44	32527		55"	119.80	YARD	16	
32439	17"	54"	336.00	YARD	40	32528	28 1/2"	1/2"	157.00	YARD	30	
32440	10"	55"	129.00	YARD	18	32529	11"	58"	119.00	YARD	15	
32443		54"	149.00	YARD	20	32530	9"	53"	149.00	YARD	25	
32444		54"	149.80	YARD	20	32532	1 1/2"	1/2"	97.00	YARD	12	
32445	14 1/2"	1/2"	197.00	YARD	35	32533	10 1/2"	59"	139.00	YARD	19	
32447	16"	1/2"	169.00	YARD	25	32534		5"	59"	149.00	YARD	20
32449		55"	316.00	YARD	44	32535	1 1/2"	1/2"	99.00	YARD	16	
32450		54"	248.00	YARD		32536	22 1/2"	59"	177.00	YARD	27	
32453		55"	199.00	YARD	27	32537		1/2"	79.80	YARD	10	
32455		54"	358.00	YARD	65	32538	9 1/2"	56"	149.00	YARD	18	
32456		53"	396.00	YARD	71	32539	9 1/2"	1/2"	99.00	YARD	13	
32464		110"	109.80	YARD	30	32540		58"	79.80	YARD	10	
32466		110"	109.00	YARD	26	32541	10"	58"	159.00	YARD	20	
32468		55"	197.00	YARD	22	32542		58"	85.00	YARD	13	
32470		57"	59.80	YARD	6	32543		1/2"	119.00	YARD	14	
32471	13 1/2"	55"	149.00	YARD	22	32544	4 1/2"	58"	149.00	YARD	18	
32472	4 1/2"	1/2"	149.00	YARD	25	32545	9"	1/2"	139.00	YARD	17	
32474	13"	1/2"	139.00	YARD	19	32546	4"	58"	149.00	YARD	20	
32475	4"	57"	149.00	YARD	20	32547	7"	56"	99.00	YARD	12	
32476	14 1/2"	1/2"	149.00	YARD	22	32548	7"	1/2"	177.00	YARD	27	
32477	6"	1/2"	149.00	YARD	27	32549	5"	1/2"	139.00	YARD	18	
32478	13 1/2"	54"	119.00	YARD	15	32550		1/2"	99.00	YARD	14	
32479		59"	59.00	YARD	10	32552	4"	57"	149.00	YARD	18	
32480		58"	109.00	YARD	16	32553	8"	55"	119.00	YARD	15	
32481	2 1/2"	54"	99.80	YARD	13	32554		56"	69.00	YARD	11	
32482	7 1/2"	54"	99.80	YARD	14	32555		56"	79.80	YARD	10	
32483	2"	54"	149.00	YARD	19	32556		1/2"	98.90	YARD	11	
32484	10"	53"	169.00	YARD	28	32557	25"	58"	149.00	YARD	22	
32485	7"	54"	159.00	YARD	24	32558	2"	56"	79.80	YARD	14	
32486	27"	54"	79.00	YARD	11	32559	32"	55"	149.00	YARD	25	
32487		54"	99.00	YARD	17	32561		59"	119.00	YARD	15	
32488	13 1/2"	54"	99.00	YARD	16	32562	8"	58"	129.00	YARD	16	
32490		53"	97.00	YARD	12	32564	4"	60"	99.00	YARD	14	
32491		55"	99.00	YARD	12	32565		55"	78.90	YARD	5	
32492		54"	99.00	YARD	12	32566	5"	58"	145.00	YARD	18	
32493		55"	99.80	YARD	14	32567	10"	55"	149.00	YARD	18	
32494	5 1/2"	54"	159.00	YARD	23	32569	4"	55"	119.00	YARD	14	
32495		53"	199.00	YARD	26	32570		1/2"	125.00	YARD	16	
32497		54"	59.00	YARD	6	32571	13"	58"	139.00	YARD	21	

Prices herein quoted are suggested retail. Prices are subject to change without notice. All shipping and special processing charges are additional.

US Retail Price List - August 2016

Pattern	Repeat	Width	Price	UOM	Grade	Pattern	Repeat	Width	Price	UOM	Grade	
32572	17	1/2"	54"	149.00	YARD	25 32650	14"	54"	119.00	YARD	23	
32574		10"	54"	129.00	YARD	16 32651	26"	54"	109.80	YARD	16	
32578	13	1/2"	54"	99.00	YARD	14 32652	15	1/2"	54"	129.00	YARD	19
32579	16	1/2"	55"	139.00	YARD	20 32653		27"	55"	197.00	YARD	40
32581		15"	1/2"	197.00	YARD	35 32654		7"	55"	149.00	YARD	21
32582	13	1/2"	55"	79.00	YARD	11 32657	11	1/2"	51"	99.80	YARD	23
32584		14"	1/2"	157.00	YARD	24 32659		54"	54"	92.90	YARD	18
32585		10"	1/2"	129.00	YARD	17 32661		54"	57.90	YARD	19	
32586	5	1/2"	54"	169.00	YARD	21 32662		55"	66.90	YARD	17	
32587	5	1/2"	54"	159.00	YARD	20 32663		55"	66.90	YARD	15	
32588	6	1/2"	54"	197.00	YARD	30 32666		2"	54"	52.90	YARD	13
32590		6"	54"	139.00	YARD	20 32667	6	1/2"	55"	47.90	YARD	10
32591		9"	53"	169.00	YARD	28 32668		55"	47.90	YARD	9	
32592		9"	54"	199.00	YARD	28 32669	6	1/2"	56"	68.90	YARD	15
32593	18	1/2"	51"	129.00	YARD	20 32670		6"	1/2"	136.90	YARD	36
32594	18	1/2"	54"	129.00	YARD	19 32671		3"	54"	57.90	YARD	13
32595		18"	55"	149.00	YARD	22 32672	7	1/2"	50"	151.90	YARD	40
32596		7"	54"	99.00	YARD	14 32675		3"	54"	58.90	YARD	14
32597		34"	54"	62.50	YARD	18 32676		1"	54"	62.90	YARD	17
32599		7"	54"	62.50	YARD	14 32677		55"	66.90	YARD	15	
32601		54"	67.00	YARD	15 32678		54"	66.90	YARD	15		
32602		54"	57.50	YARD	14 32679		54"	66.90	YARD	15		
32603		54"	67.00	YARD	15 32681		54"	66.90	YARD	15		
32604		56"	67.00	YARD	15 32683		55"	46.90	YARD	15		
32605	4	1/2"	54"	62.50	YARD	14 32686		55"	41.90	YARD	9	
32606		54"	47.90	YARD	9 32688		1	1/2"	56"	55.90	YARD	18
32607		54"	71.90	YARD	20 32689			6"	57"	59.90	YARD	15
32608		18"	54"	62.50	YARD	16 32690	15	1/2"	53"	93.90	YARD	27
32610		19"	54"	81.50	YARD	21 32692		54"	53.90	YARD	10	
32611		54"	57.90	YARD	13 32693		54"	51.90	YARD	12		
32612		54"	81.50	YARD	18 32694		54"	63.90	YARD	12		
32613		54"	57.90	YARD	17 32695		2"	54"	58.90	YARD	11	
32615		12"	56"	62.50	YARD	14 32696		6"	54"	84.90	YARD	5
32616		55"	67.00	YARD	15 32698		15	1/2"	54"	119.80	YARD	24
32617		54"	105.90	YARD	24 32700		2"	53"	58.90	YARD	17	
32618		4"	54"	129.00	YARD	17 32701		9"	55"	89.90	YARD	26
32619		7"	55"	79.00	YARD	10 32702		54"	24.90	YARD	5	
32620		8"	54"	99.00	YARD	11 32704		54"	29.50	YARD	5	
32621		54"	41.90	YARD	9 32706		9"	52"	119.90	YARD	32	
32622		55"	38.50	YARD	9 32707			1/2"	41.90	YARD	10	
32623		14"	54"	115.00	YARD	18 32708		54"	37.50	YARD	13	
32624		18"	54"	115.00	YARD	19 32709		54"	58.90	YARD	15	
32625		10"	54"	99.80	YARD	15 32710		54"	41.90	YARD	10	
32626	13	1/2"	54"	177.00	YARD	28 32713	6	1/2"	54"	51.50	YARD	13
32627	13	1/2"	54"	115.00	YARD	18 32714		8"	54"	49.50	YARD	12
32628	17	1/2"	54"	139.00	YARD	21 32715		1"	54"	63.50	YARD	16
32629		54"	197.00	YARD	32716		1"	55"	296.00	YARD	33	
32631		9"	58"	149.00	YARD	20 32717		7"	54"	55.90	YARD	16
32632		8"	55"	197.00	YARD	22 32722	53	1/2"	58"	62.90	YARD	24
32635		3"	1/2"	296.00	YARD	34 32724		54"	37.50	YARD	9	
32636		29"	55"	350.00	YARD	55 32725		54"	59.90	YARD	13	
32637	23	1/2"	55"	196.00	YARD	33 32726		54"	63.50	YARD	15	
32638	7	1/2"	54"	199.00	YARD	28 32727		55"	199.00	YARD	24	
32639		26"	55"	129.00	YARD	32730		54"	59.90	YARD	15	
32640	11	1/2"	54"	119.00	YARD	16 32731		55"	49.90	YARD	14	
32642		54"	31.90	YARD	5 32732		54"	57.00	YARD	11		
32643	37	1/2"	1/2"	169.00	YARD	32 32733	4	1/2"	54"	149.00	YARD	24
32644		27"	54"	119.00	YARD	21 32734	4	1/2"	54"	159.00	YARD	24
32645		26"	54"	179.00	YARD	32736		3"	54"	59.90	YARD	14
32646		8"	54"	139.00	YARD	19 32737	4	1/2"	52"	119.00	YARD	16
32647	7	1/2"	54"	149.00	YARD	21 32738		54"	39.90	YARD	13	
32648	8	1/2"	54"	139.00	YARD	19 32739	14	1/2"	54"	55.90	YARD	14
32649	18	1/2"	54"	197.00	YARD	34 32740		16"	51"	157.00	YARD	28

Prices herein quoted are suggested retail. Prices are subject to change without notice. All shipping and special processing charges are additional.

US Retail Price List - August 2016

Pattern	Repeat	Width	Price	UOM	Grade	Pattern	Repeat	Width	Price	UOM	Grade	
32742		55"	29.50	YARD	8	32829		54"	69.80	YARD	8	
32748		56"	52.90	YARD	12	32832	25	1/2"	54"	95.00	YARD	17
32751	4	1/2"	54"	67.00	YARD	18		54"	119.80	YARD	16	
32753		54"	49.00	YARD	11	32834	9"	54"	119.00	YARD	15	
32754	6	1/2"	54"	65.90	YARD	15	9"	54"	139.00	YARD	18	
32755		55"	97.00	YARD	14	32836	7"	57"	129.00	YARD	18	
32756		54"	41.90	YARD	9	32837		55"	157.60	YARD	17	
32759	5"	53"	256.00	YARD	40	32839		54"	95.00	YARD	19	
32760	28	1/2"	53"	276.00	YARD	53	4	1/2"	56"	79.80	YARD	9
32761		13"	53"	276.00	YARD		14"	55"	99.00	YARD	14	
32764		3"	54"	67.00	YARD	17	13"	1/2"	99.00	YARD	20	
32767		54"	49.50	YARD	11	32845	3"	1/2"	97.00	YARD	12	
32770		16"	1/2"	177.00	YARD	35	4"	1/2"	119.00	YARD	21	
32771		5"	55"	146.90	YARD	35	1	1/2"	55"	119.00	YARD	20
32772		56"	47.00	YARD	10	32850	9"	1/2"	177.00	YARD	25	
32773		4"	56"	47.00	YARD	11	18"	55"	149.00	YARD	18	
32775		54"	49.90	YARD	12	32852		55"	59.80	YARD	5	
32776		54"	49.90	YARD	11	32853		54"	95.00	YARD	24	
32777		54"	75.90	YARD	16	32854		54"	197.00	YARD		
32778		54"	55.90	YARD	16	32855		54"	43.00	YARD	10	
32779	5	1/2"	54"	49.90	YARD	12		54"	70.90	YARD	22	
32781		5"	53"	199.00	YARD	37		55"	57.90	YARD	14	
32782		54"	58.90	YARD	12	32859		56"	42.90	YARD	9	
32783		54"	115.00	YARD	12	32860		54"	42.90	YARD	10	
32784		54"	129.00	YARD	17	32861	7"	54"	59.50	YARD	14	
32785		19"	54"	199.00	YARD	30		54"	31.90	YARD	5	
32786	13	1/2"	55"	298.00	YARD	37		55"	78.90	YARD	13	
32787		54"	89.90	YARD	25	32865	1"	54"	64.90	YARD	17	
32788		18"	1/2"	139.00	YARD	23	8"	54"	59.90	YARD	14	
32789		55"	79.50	YARD	22	32867	28"	1/2"	159.00	YARD	26	
32790	9	1/2"	56"	79.00	YARD	8		55"	159.00	YARD	19	
32791	2	1/2"	56"	79.00	YARD	7		57"	256.00	YARD	36	
32792		57"	59.00	YARD	6	32870		53"	149.00	YARD	25	
32793		56"	55.00	YARD	6	32871		54"	61.90	YARD	11	
32794		53"	97.00	YARD	12	32872		54"	99.80	YARD	19	
32795		3"	53"	117.00	YARD	18	1"	54"	177.00	YARD	19	
32796		55"	79.00	YARD	8	32874	18	1/2"	54"	149.00	YARD	
32797		2"	55"	149.00	YARD	20	15"	54"	298.00	YARD		
32798	9	1/2"	54"	97.00	YARD	13		54"	85.00	YARD	11	
32799		4"	1/2"	149.00	YARD	24		55"	99.80	YARD	5	
32801	23	1/2"	53"	197.00	YARD	36	29"	54"	298.00	YARD		
32803		55"	199.00	YARD		32880		53"	199.00	YARD	34	
32806		55"	69.00	YARD	7	32881	31"	1/2"	199.00	YARD	40	
32808		56"	290.00	YARD	27	32882	14	1/2"	52"	290.00	YARD	45
32809		26"	53"	290.00	YARD	47	1"	52"	248.00	YARD	41	
32810		54"	39.90	YARD	8	32885		54"	149.00	YARD	27	
32811		54"	115.00	YARD	12	32886	13	1/2"	54"	276.00	YARD	39
32812		18"	54"	296.00	YARD	41	30"	58"	117.00	YARD	21	
32813		23"	50"	296.00	YARD	51	43"	54"	276.00	YARD		
32814		58"	75.00	YARD	15	32889	28"	56"	129.00	YARD	20	
32815		55"	79.90	YARD	23	32890	4"	1/2"	99.00	YARD	18	
32817		54"	85.00	YARD	19	32891	38	1/2"	57"	129.80	YARD	22
32818		54"	93.90	YARD	25	32892	7	1/2"	1/2"	99.00	YARD	17
32819		55"	78.90	YARD	13	32893	1"	54"	109.00	YARD	20	
32820		54"	69.80	YARD	20	32894	8"	55"	109.00	YARD	20	
32821		7"	1/2"	99.00	YARD	16	4	1/2"	55"	97.00	YARD	16
32822		2"	55"	89.80	YARD	11	6"	1/2"	99.80	YARD	18	
32823	2	1/2"	1/2"	89.80	YARD	12	2"	55"	99.00	YARD	18	
32824	6	1/2"	1/2"	99.00	YARD	16	30	1/2"	54"	99.80	YARD	22
32825		9"	58"	99.80	YARD	14	15"	57"	119.00	YARD	19	
32826	13	1/2"	1/2"	119.00	YARD	17	9"	1/2"	99.80	YARD	20	
32827		5"	1/2"	99.00	YARD	12	27"	1/2"	129.00	YARD	29	
32828	1	1/2"	1/2"	139.00	YARD	19	13"	52"	99.00	YARD	14	

Prices herein quoted are suggested retail. Prices are subject to change without notice. All shipping and special processing charges are additional.

US Retail Price List - August 2016

Pattern	Repeat	Width	Price	UOM	Grade	Pattern	Repeat	Width	Price	UOM	Grade
32903		8" 1/2"	89.00	YARD	14	32976	13	1/2" 54"	177.00	YARD	32
32904	29	1/2" 57"	129.00	YARD	22	32977		55"	77.00	YARD	5
32906		52"	119.00	YARD	24	32978		54"	177.00	YARD	17
32908	15	1/2" 56"	119.00	YARD	21	32979		1/2" 59.80	YARD	5	
32909		22" 55"	97.00	YARD	17	32980		56"	55.00	YARD	5
32910		55"	97.00	YARD	18	32981		54"	59.80	YARD	5
32911		1" 1/2"	99.80	YARD	18	32983		54"	59.00	YARD	5
32912		7" 1/2"	97.00	YARD	14	32984		54"	75.00	YARD	14
32914		28" 55"	189.00	YARD	28	32985		13" 54"	177.00	YARD	24
32915		1" 53"	149.00	YARD	27	32986		28" 54"	199.00	YARD	31
32916		54"	199.00	YARD	22	32987		13" 54"	264.00	YARD	37
32917		2" 54"	157.00	YARD	23	32988		26" 54"	276.00	YARD	43
32918	1	1/2" 54"	77.90	YARD	20	32989		54"	59.90	YARD	5
32919	6	1/2" 1/2"	87.00	YARD	15	32990		1/2" 69.90	YARD	5	
32920		54"	99.00	YARD	14	32991	1	1/2" 59"	79.00	YARD	5
32921		6" 54"	97.00	YARD	15	32992		58"	58.90	YARD	5
32922		56"	59.80	YARD	8	32993		54"	109.00	YARD	18
32923		10" 54"	87.00	YARD	14	32994		3" 53"	99.00	YARD	13
32924	2	1/2" 56"	99.00	YARD	5	32995		55"	236.00	YARD	25
32925		15" 56"	99.80	YARD	21	32996		30" 61"	296.00	YARD	56
32926	7	1/2" 1/2"	99.80	YARD	18	32997		54"	79.80	YARD	17
32927		10" 55"	99.80	YARD	19	32998		3" 54"	75.00	YARD	8
32928	5	1/2" 55"	109.00	YARD	20	33000		55"	79.90	YARD	17
32929		5" 1/2"	119.00	YARD	20	33001		55"	99.80	YARD	14
32930		3" 56"	99.80	YARD	14	33002	2	1/2" 56"	99.00	YARD	14
32931		54"	87.00	YARD	16	33004		54"	179.00	YARD	28
32932	4	1/2" 1/2"	99.80	YARD	20	33005		18" 54"	59.90	YARD	5
32933	13	1/2" 1/2"	99.80	YARD	21	33006		54"	44.90	YARD	5
32934	13	1/2" 1/2"	97.00	YARD	17	33007		55"	37.90	YARD	5
32935	6	1/2" 54"	99.80	YARD	20	33008		54"	59.80	YARD	9
32936		7" 1/2"	99.80	YARD	17	33009		54"	75.00	YARD	10
32937		55"	97.00	YARD	15	33010		55"	39.90	YARD	5
32938		14" 56"	179.00	YARD	29	33011		1/2" 69.80	YARD	5	
32939		55"	179.00	YARD	25	33012		1/2" 59.80	YARD	5	
32943		56"	99.00	YARD	11	33013		55"	59.80	YARD	5
32945		27" 54"	129.00	YARD		33014		56"	49.90	YARD	5
32946		58"	99.00	YARD	5	33015		9" 51"	99.80	YARD	20
32947		1/2" 290.00	YARD	26	33016		3" 54"	65.90	YARD	5	
32948		55"	199.00	YARD	18	33017		56"	59.90	YARD	5
32949		55"	199.00	YARD	23	33018		1/2" 59.90	YARD	5	
32950		55"	199.00	YARD	24	33019		37" 55"	296.00	YARD	38
32952		1" 54"	97.00	YARD	5	33020		1/2" 68.90	YARD	5	
32953		54"	97.00	YARD	5	33021		4" 60"	68.90	YARD	5
32954		12" 54"	99.80	YARD	5	33022	1	1/2" 58"	59.90	YARD	5
32955		54"	59.90	YARD	5	33023		57"	45.90	YARD	5
32957		54"	49.90	YARD	5	33024		1/2" 75.00	YARD	5	
32958	6	1/2" 54"	79.00	YARD	5	33025		1/2" 59.90	YARD	5	
32959		53"	87.00	YARD	5	33026		58"	65.90	YARD	5
32960		54"	45.90	YARD	5	33027		1/2" 69.90	YARD	5	
32961		54"	87.00	YARD	5	33028		1/2" 59.90	YARD	5	
32962		53"	89.80	YARD	5	33029		2" 58"	67.90	YARD	5
32963		55"	99.00	YARD	5	33030		54"	68.90	YARD	5
32964		54"	79.00	YARD	5	33031		58"	199.00	YARD	29
32965		54"	79.80	YARD	5	33032		24" 58"	197.00	YARD	35
32966		56"	52.90	YARD	5	33033		54"	79.00	YARD	5
32967		56"	54.90	YARD	5	33034		54"	79.80	YARD	5
32968		55"	68.90	YARD	5	33035		54"	79.00	YARD	5
32969		55"	79.00	YARD	5	33036		54"	69.80	YARD	5
32971		54"	44.90	YARD	5	33037		25" 1/2"	197.00	YARD	41
32972		7" 54"	197.00	YARD	24	33038		54"	69.80	YARD	5
32973		55"	220.00	YARD	25	33039		54"	79.80	YARD	5
32974		55"	197.00	YARD	19	33040		54"	58.90	YARD	5
32975		54"	59.80	YARD	5	33041		3" 54"	49.90	YARD	5

Prices herein quoted are suggested retail. Prices are subject to change without notice. All shipping and special processing charges are additional.

US Retail Price List - August 2016

Pattern	Repeat	Width	Price	UOM	Grade	Pattern	Repeat	Width	Price	UOM	Grade
33042	12	1/2"	248.00	YARD	43	33117		55"	248.00	YARD	30
33043		54"	59.90	YARD	5	33118		55"	270.00	YARD	
33044		54"	149.00	YARD	19	33119		54"	42.90	YARD	8
33045	1	1/2"	59.90	YARD	5	33120		56"	43.90	YARD	14
33048		1/2"	55.90	YARD	5	33122		54"	390.00	YARD	
33049	6	1/2"	99.00	YARD	5	33123	28"	54"	220.00	YARD	
33050		54"	49.80	YARD	5	33124		54"	276.00	YARD	35
33051		54"	48.90	YARD	5	33125		55"	129.90	YARD	17
33052		1"	55.90	YARD	5	33126	27"	54"	284.00	YARD	44
33053		54"	46.90	YARD	5	33127		55"	179.90	YARD	23
33054		1"	58.90	YARD	5	33131	13"	53"	189.00	YARD	29
33055		4"	49.90	YARD	5	33132	7"	56"	79.80	YARD	9
33056	2	1/2"	49.90	YARD	5	33134	7"	56"	79.80	YARD	5
33057	14	1/2"	99.00	YARD	5	33135		56"	59.80	YARD	5
33060		29"	75.00	YARD	25	33136		56"	49.00	YARD	6
33061		55"	149.00	YARD	14	33137	14"	54"	169.00	YARD	21
33062		54"	119.80	YARD	20	33138	13"	54"	179.00	YARD	23
33063		54"	69.90	YARD	20	33139		56"	55.00	YARD	5
33064		27"	54"	328.00	YARD	54	33140	54"	59.80	YARD	5
33065	15	1/2"	52"	328.00	YARD	59	3 1/2"	1/2"	197.00	YARD	23
33066	31	1/2"	52"	296.00	YARD	58	2"	54"	197.00	YARD	26
33067		55"	197.00	YARD	19	33143	1"	54"	197.00	YARD	24
33068	29	1/2"	1/2"	296.00	YARD	63	7"	54"	79.80	YARD	14
33069		30"	48"	350.00	YARD	69	4 1/2"	50"	129.00	YARD	18
33070		54"	236.00	YARD	35	33150		53"	139.00	YARD	15
33071		12"	53"	364.00	YARD	57	14"	55"	149.00	YARD	21
33072		7"	55"	197.00	YARD	30	59"	97.00	YARD	20	
33073	15	1/2"	51"	336.00	YARD	68	55"	119.90	YARD	23	
33074		54"	220.00	YARD	30	33157	5 1/2"	54"	99.00	YARD	18
33077		55"	158.00	YARD	23	33160	4"	54"	177.00	YARD	32
33078	6	1/2"	55"	197.00	YARD	31	55"	119.00	YARD	12	
33079	31	1/2"	52"	344.00	YARD		5"	54"	115.00	YARD	15
33080		30"	49"	298.00	YARD	56	19"	53"	129.00	YARD	20
33082		15"	53"	396.00	YARD	79	4"	54"	139.00	YARD	23
33083		1/2"	179.00	YARD		33165	8"	54"	139.00	YARD	18
33084	31	1/2"	52"	338.00	YARD		54"	59.80	YARD	9	
33085	15	1/2"	47"	236.00	YARD	55	5 1/2"	54"	99.00	YARD	19
33086	31	1/2"	53"	196.00	YARD	45	54"	89.90	YARD	8	
33087		55"	248.00	YARD	24	33169	8"	54"	119.00	YARD	15
33088		4"	54"	139.00	YARD	24	3 1/2"	54"	119.00	YARD	16
33089		55"	177.00	YARD	19	33171	2"	54"	119.00	YARD	19
33090		55"	179.00	YARD	20	33173		54"	159.00	YARD	20
33091		55"	198.00	YARD	43	33174	15 1/2"	54"	139.00	YARD	20
33093		55"	148.00	YARD	22	33175	12"	54"	99.00	YARD	17
33094		4"	58"	248.00	YARD	28	58"	119.00	YARD	16	
33095		36"	55"	199.00	YARD	34	4"	57"	169.00	YARD	21
33096	8	1/2"	54"	230.00	YARD	34	56"	129.00	YARD	17	
33097		55"	99.00	YARD	16	33180	7"	55"	99.00	YARD	13
33098		10"	55"	248.00	YARD	27	3"	54"	129.00	YARD	20
33099		55"	177.00	YARD		33182		54"	129.00	YARD	16
33101	14	1/2"	50"	129.00	YARD	21	54"	129.00	YARD	17	
33103		54"	99.80	YARD	19	33184	11"	54"	177.00	YARD	23
33104		54"	115.00	YARD	22	33185		54"	169.00	YARD	25
33105		1"	56"	54.90	YARD	9	53"	298.00	YARD	40	
33106	1	1/2"	55"	54.90	YARD	10	3"	54"	189.00	YARD	22
33107	13	3/4"	54"	54.90	YARD	13	54"	109.00	YARD	22	
33108		56"	54.90	YARD	8	33195	1"	57"	119.00	YARD	16
33109	15	1/2"	51"	264.00	YARD	49	13 1/2"	1/2"	119.80	YARD	16
33110		54"	46.90	YARD	15	33197	24 1/2"	1/2"	119.80	YARD	
33111		12"	54"	330.00	YARD	47	56"	37.90	YARD	13	
33112		14"	54"	197.00	YARD		4"	1/2"	179.00	YARD	
33115		54"	197.00	YARD	21	33200		58"	115.00	YARD	17
33116		54"	57.90	YARD	11	33201	3 1/2"	55"	169.00	YARD	24

Prices herein quoted are suggested retail. Prices are subject to change without notice. All shipping and special processing charges are additional.

US Retail Price List - August 2016

Pattern	Repeat	Width	Price	UOM	Grade	Pattern	Repeat	Width	Price	UOM	Grade	
33202		3"	54"	149.00	YARD	22 33268		12"	54"	64.90	YARD	14
33203			54"	169.00	YARD	17 33269		3"	54"	78.90	YARD	17
33204		1/2"	52"	149.00	YARD	20 33270		2"	54"	42.90	YARD	10
33205			58"	115.00	YARD	16 33271		8"	55"	99.80	YARD	20
33206		6"	53"	137.00	YARD	22 33272			59"	596.00	YARD	61
33207		8"	54"	197.00	YARD	24 33274			55"	57.90	YARD	17
33208		2"	54"	129.00	YARD	19 33275		1 1/2"	54"	57.90	YARD	14
33210			54"	44.90	YARD	9 33276		21"	54"	177.00	YARD	26
33211		7 1/2"	53"	99.80	YARD	13 33277			55"	47.90	YARD	10
33212		32 1/2"	57"	119.80	YARD	20 33278		20"	53"	139.00	YARD	30
33213		27 1/2"	56"	189.00	YARD	33 33279			56"	290.00	YARD	39
33214			54"	49.90	YARD	9 33280			54"	59.90	YARD	17
33215			51"	159.00	YARD	29 33281			54"	47.90	YARD	15
33216		31"	55"	189.00	YARD	38 33282		8"	52"	99.00	YARD	25
33217		8"	54"	109.00	YARD	23 33283			55"	54.90	YARD	13
33218		18"	55"	119.00	YARD	33284		7"	55"	69.90	YARD	18
33219		33"	53"	149.00	YARD	25 33285			54"	55.90	YARD	11
33220		24"	54"	129.00	YARD	17 33286		6"	54"	51.90	YARD	14
33221		32"	56"	119.00	YARD	33287		1"	54"	84.90	YARD	25
33222		11"	54"	119.00	YARD	33288			55"	84.90	YARD	19
33223			54"	57.00	YARD	5 33289		4 1/2"	54"	91.90	YARD	28
33224			58"	47.90	YARD	15 33290		6"	54"	84.90	YARD	26
33225			54"	53.90	YARD	5 33291		9"	54"	99.00	YARD	25
33226			54"	57.90	YARD	5 33292			56"	72.90	YARD	21
33227			55"	244.00	YARD	27 33293		11 1/2"	57"	75.90	YARD	25
33228			54"	149.00	YARD	19 33294		5"	54"	91.90	YARD	29
33229			54"	115.00	YARD	19 33295		9"	54"	109.90	YARD	29
33230			55"	169.00	YARD	23 33296			54"	85.90	YARD	24
33231		29 1/2"	55"	296.00	YARD	52 33297			54"	51.90	YARD	12
33232		6 3/4"	54"	149.00	YARD	21 33298			56"	38.90	YARD	8
33233			55"	57.90	YARD	11 33299			54"	77.90	YARD	14
33234			54"	69.90	YARD	15 33300		1"	57"	52.90	YARD	14
33235			56"	43.90	YARD	9 33301		31"	54"	96.90	YARD	27
33236		6"	54"	87.00	YARD	13 33302		9"	52"	115.00	YARD	35
33237		6"	54"	87.00	YARD	19 33303		33 1/2"	54"	109.90	YARD	32
33238		8"	53"	44.90	YARD	12 33304		6"	54"	61.90	YARD	15
33239		1 1/2"	54"	119.00	YARD	19 33305		6"	54"	71.90	YARD	17
33240		6"	1/2"	59.90	YARD	23 33306		1"	55"	81.90	YARD	18
33241			54"	46.90	YARD	10 33307		1"	54"	91.90	YARD	20
33242			56"	38.90	YARD	7 33308		3 1/2"	54"	57.90	YARD	13
33243		6"	53"	99.80	YARD	16 33309		6"	52"	109.90	YARD	29
33244			53"	199.00	YARD	34 33310		9"	52"	109.90	YARD	35
33246			54"	42.90	YARD	9 33311			55"	76.90	YARD	15
33248		12"	57"	52.90	YARD	13 33312			56"	80.90	YARD	22
33249			54"	37.90	YARD	7 33314			54"	109.90	YARD	29
33250			54"	51.90	YARD	10 33315			54"	62.90	YARD	12
33251		12"	51"	185.00	YARD	30 33316		6"	52"	109.90	YARD	35
33252			54"	51.90	YARD	10 33317		1"	54"	57.90	YARD	15
33253		6"	54"	51.90	YARD	12 33319			54"	76.90	YARD	18
33254			54"	58.90	YARD	11 33320		9"	1/2"	95.90	YARD	31
33255		15 1/2"	51"	149.00	YARD	29 33321			56"	52.90	YARD	12
33256			53"	199.00	YARD	23 33322			55"	69.90	YARD	16
33257		10"	51"	149.00	YARD	29 33323		9"	52"	109.90	YARD	32
33258			51"	298.00	YARD	39 33324		6"	54"	57.90	YARD	13
33259			51"	248.00	YARD	28 33325			54"	103.50	YARD	
33260			49"	199.00	YARD	30 33326			54"	129.90	YARD	
33261		5"	50"	179.00	YARD	29 33327			56"	65.90	YARD	13
33262			56"	47.90	YARD	10 33328		21"	54"	57.90	YARD	14
33263			56"	47.90	YARD	9 33329		3"	54"	197.00	YARD	
33264		4"	52"	47.90	YARD	12 33331			54"	41.90	YARD	9
33265			53"	79.80	YARD	10 33332			54"	94.90	YARD	5
33266		28 1/2"	55"	298.00	YARD	33333			54"	73.90	YARD	5
33267			51"	298.00	YARD	36 33334			58"	57.90	YARD	5

Prices herein quoted are suggested retail. Prices are subject to change without notice. All shipping and special processing charges are additional.

US Retail Price List - August 2016

Pattern	Repeat	Width	Price	UOM	Grade	Pattern	Repeat	Width	Price	UOM	Grade
33335		54"	71.90	YARD	5	33426	22"	53"	270.00	YARD	43
33336	2"	54"	73.90	YARD	5	33427	13 1/2"	54"	197.00	YARD	40
33337		54"	79.80	YARD	5	33428	12"	54"	169.00	YARD	26
33338		54"	73.90	YARD	5	33429	28 1/2"	54"	179.00	YARD	32
33340		54"	57.90	YARD	5	33430	9 1/2"	52"	115.00	YARD	23
33342		54"	55.90	YARD	5	33432	19"	54"	336.00	YARD	49
33343		54"	79.80	YARD	5	33434		54"	69.00	YARD	15
33344		54"	71.90	YARD	5	33435	27"	54"	199.00	YARD	35
33345		55"	69.80	YARD	5	33436	7"	54"	159.00	YARD	25
33346	6 1/2"	54"	79.80	YARD	5	33437	1"	57"	79.80	YARD	16
33348	21"	54"	169.00	YARD	31	33439	27"	56"	129.00	YARD	18
33349	2 1/2"	57"	71.90	YARD	5	33440	4"	56"	119.00	YARD	16
33350		58"	75.90	YARD	5	33441	14"	55"	199.00	YARD	39
33351	1/2"	98.90	YARD	5	33442		55"	236.00	YARD	23	
33352		55"	65.00	YARD	5	33443		55"	196.00	YARD	19
33353		55"	69.80	YARD	10	33444	27"	54"	149.00	YARD	27
33354		54"	79.80	YARD	5	33445	15"	55"	169.00	YARD	26
33356		54"	73.90	YARD	5	33446	16"	51"	177.00	YARD	33
33358		54"	89.80	YARD	5	33447	27"	58"	149.00	YARD	25
33363		54"	79.80	YARD	15	33448	3"	57"	169.00	YARD	22
33376		54"	79.80	YARD	5	33449		59"	89.00	YARD	14
33378		54"	115.00	YARD	5	33450	2"	58"	119.00	YARD	16
33379		54"	75.00	YARD	5	33451		56"	89.80	YARD	20
33380		54"	69.00	YARD	5	33452		54"	191.00	YARD	20
33381		54"	59.00	YARD	5	33453		55"	298.00	YARD	
33382		54"	45.90	YARD	5	33454	15"	54"	236.00	YARD	33
33383		54"	61.90	YARD	5	33455		55"	290.00	YARD	29
33384		54"	69.00	YARD	5	33456		57"	189.00	YARD	26
33385		54"	115.00	YARD	5	33457	21 1/2"	55"	197.00	YARD	30
33386		54"	59.80	YARD	5	33458	9"	59"	119.00	YARD	16
33387	2"	54"	89.80	YARD	5	33459		59"	99.00	YARD	15
33388		54"	65.00	YARD	5	33460	16"	57"	169.00	YARD	24
33389		54"	69.00	YARD	5	33461	18"	57"	270.00	YARD	38
33390		54"	69.80	YARD	5	33462		57"	298.00	YARD	29
33392		54"	159.00	YARD	5	33463		55"	248.00	YARD	25
33393		54"	59.00	YARD	5	33464	20"	52"	197.00	YARD	35
33394		54"	59.00	YARD	5	33465	7"	54"	177.00	YARD	23
33395		54"	59.80	YARD	5	33483		55"	197.00	YARD	20
33396		54"	49.90	YARD	5	33484		54"	396.00	YARD	40
33399		54"	79.80	YARD	5	33485	7"	57"	129.00	YARD	16
33400		54"	53.90	YARD	5	33486		1/2"	276.00	YARD	
33401		55"	57.00	YARD	5	33487		54"	177.00	YARD	31
33402		58"	99.00	YARD	5	33488		55"	189.00	YARD	18
33404	6"	53"	149.00	YARD	23	33489	9 1/2"	47"	450.00	YARD	
33405	2 1/2"	3/4"	85.00	YARD	5	33492		54"	77.90	YARD	5
33406		55"	59.80	YARD	7	33494	20 1/2"	1/2"	199.00	YARD	40
33407	13 1/2"	54"	88.00	YARD	10	33495		55"	149.00	YARD	18
33408	4 1/2"	56"	79.00	YARD	6	33496		55"	149.00	YARD	14
33409		54"	75.00	YARD	5	33497	3"	55"	169.00	YARD	19
33410	9"	55"	79.80	YARD	10	33499	1 1/2"	1/2"	290.00	YARD	
33411	9 1/2"	56"	58.00	YARD	7	33500	1"	55"	157.00	YARD	21
33412	6 1/2"	54"	119.00	YARD	15	33501		55"	139.00	YARD	14
33413	13"	52"	159.00	YARD	30	33503	15"	54"	149.00	YARD	23
33414	6 3/4"	54"	87.00	YARD	11	33507		51"	256.00	YARD	33
33416		53"	43.90	YARD	15	33509	7"	55"	248.00	YARD	28
33417	26"	55"	99.80	YARD		33510	13 1/2"	1/2"	177.00	YARD	28
33418	9"	53"	157.00	YARD		33511	2"	54"	149.00	YARD	20
33419	10"	52"	397.00	YARD		33512	5 1/2"	54"	197.00	YARD	32
33420	15"	50"	149.00	YARD	30	33513	1 1/2"	54"	139.00	YARD	25
33421		54"	77.00	YARD	13	33514		55"	350.00	YARD	42
33422	16"	50"	236.00	YARD	43	33515		54"	169.00	YARD	24
33423		54"	149.00	YARD	22	33516		54"	248.00	YARD	35
33424		54"	149.00	YARD	17	33517	1 1/2"	49"	296.00	YARD	55

Prices herein quoted are suggested retail. Prices are subject to change without notice. All shipping and special processing charges are additional.

US Retail Price List - August 2016

Pattern	Repeat	Width	Price	UOM	Grade	Pattern	Repeat	Width	Price	UOM	Grade
33519	7 1/2"	54"	159.00	YARD	24	33598		54"	45.00	YARD	5
33520	12 1/2"	52"	190.00	YARD	24	33599		54"	59.80	YARD	5
33521		54"	199.00	YARD	24	33600	8 1/2"	55"	298.00	YARD	37
33524		1/2"	220.00	YARD	27	33601		54"	55.00	YARD	5
33525		56"	119.00	YARD	14	33602	1"	55"	316.00	YARD	
33526		56"	119.00	YARD	14	33603	2 1/2"	54"	99.80	YARD	5
33527	8"	56"	149.00	YARD	19	33604	6 1/2"	52"	298.00	YARD	
33529	7"	54"	177.00	YARD	28	33605	12 1/2"	52"	177.00	YARD	
33534		54"	139.00	YARD	18	33607	3 1/2"	55"	316.00	YARD	
33535		55"	350.00	YARD	35	33608		55"	199.00	YARD	26
33536	18"	54"	159.00	YARD	25	33609	1"	54"	99.00	YARD	5
33537		54"	129.00	YARD	20	33610	10 1/2"	55"	169.00	YARD	28
33538	2 1/2"	54"	149.00	YARD	20	33611	19 1/2"	54"	290.00	YARD	
33539		54"	129.00	YARD	17	33613	2"	1/2"	197.00	YARD	
33540	2 1/2"	1/2"	396.00	YARD	73	33614	16"	50"	298.00	YARD	
33541		54"	97.00	YARD	19	33615	7"	54"	79.80	YARD	5
33543	4"	1/2"	396.00	YARD	84	33616	3 1/2"	54"	99.80	YARD	5
33544	4"	54"	350.00	YARD	50	33617	1 1/2"	54"	99.00	YARD	5
33547	2"	54"	89.80	YARD	17	33618	1 3/4"	54"	99.00	YARD	5
33548	15"	1/2"	396.00	YARD	76	33619	13"	52"	276.00	YARD	51
33549	8"	54"	298.00	YARD	38	33620	24 3/4"	1/2"	268.00	YARD	46
33550		54"	117.00	YARD		33621	3 3/4"	54"	99.80	YARD	5
33551	30 1/2"	49"	250.00	YARD	52	33623	1 1/2"	1/2"	199.00	YARD	25
33552		53"	376.00	YARD	52	33624	1 3/4"	1/2"	248.00	YARD	31
33553		52"	270.00	YARD	34	33625	23"	1/2"	350.00	YARD	
33554		53"	248.00	YARD	33	33626	23 1/2"	52"	169.00	YARD	
33555		55"	236.00	YARD	24	33627	12 1/2"	50"	256.00	YARD	49
33556	6"	55"	270.00	YARD	39	33628	23"	50"	396.00	YARD	
33557	1/2"	199.00	YARD	33	33629	6 1/4"	54"	119.00	YARD	20	
33558		53"	236.00	YARD	29	33630	13 1/2"	1/2"	330.00	YARD	51
33559	31"	50"	189.00	YARD		33631	26 1/2"	54"	330.00	YARD	53
33561	12 1/2"	55"	370.00	YARD	59	33632	4 1/2"	54"	99.00	YARD	14
33562	3 1/2"	55"	298.00	YARD	46	33633	31 1/2"	1/2"	376.00	YARD	
33563		54"	69.90	YARD	5	33634	8 1/2"	54"	316.00	YARD	51
33565	2 1/2"	54"	99.00	YARD	5	33635	18 1/2"	55"	197.00	YARD	18
33566		56"	49.80	YARD	5	33636	31 1/2"	56"	296.00	YARD	41
33567	4"	54"	99.80	YARD	5	33637	3"	1/2"	199.00	YARD	23
33568		54"	44.90	YARD	5	33638	4"	54"	129.00	YARD	19
33569		52"	396.00	YARD	46	33640	7"	54"	129.00	YARD	21
33570		54"	59.90	YARD	5	33641	5"	1/2"	129.00	YARD	20
33572	1 1/2"	55"	56.90	YARD	5	33642	4 1/2"	54"	139.00	YARD	21
33573	1 1/2"	54"	39.90	YARD	5	33643		55"	197.00	YARD	23
33574	9"	54"	39.90	YARD	5	33644	7"	1/2"	248.00	YARD	26
33576		55"	55.00	YARD	5	33645	2 1/4"	55"	250.00	YARD	
33577	1 1/4"	53"	99.00	YARD	5	33646		55"	149.00	YARD	16
33578		55"	31.90	YARD	5	33647	10"	54"	119.00	YARD	15
33580		55"	29.90	YARD	5	33648	1 1/4"	1/2"	298.00	YARD	33
33581		55"	29.90	YARD	5	33649	32"	55"	350.00	YARD	
33582		55"	29.90	YARD	5	33650		54"	99.80	YARD	16
33583		55"	31.90	YARD	5	33651	1 1/2"	1/2"	139.00	YARD	17
33584		54"	37.90	YARD	5	33652	6 1/4"	54"	119.00	YARD	20
33585	1 1/2"	54"	99.80	YARD	5	33653	4 1/2"	54"	99.00	YARD	14
33586	3"	54"	56.90	YARD	5	33654	7"	54"	129.00	YARD	21
33587		54"	59.80	YARD	5	33655	5"	1/2"	129.00	YARD	20
33588		56"	39.90	YARD	5	33656	4"	54"	129.00	YARD	19
33589		54"	59.80	YARD	5	33657	10"	54"	119.00	YARD	15
33591	1 1/2"	54"	79.90	YARD	5	33658	1 1/2"	1/2"	139.00	YARD	17
33592	1"	55"	37.90	YARD	5	33659		54"	99.80	YARD	16
33593	4"	58"	59.80	YARD	5	33660	4 1/2"	54"	139.00	YARD	21
33594		59"	89.80	YARD	5	33661		55"	49.00	YARD	9
33595	1/2"	99.00	YARD	5	33662	4 1/2"	58"	139.00	YARD	23	
33596	1"	54"	49.90	YARD	5	33663	4 1/2"	1/2"	139.00	YARD	21
33597		54"	79.00	YARD	5	33664		55"	78.90	YARD	13

Prices herein quoted are suggested retail. Prices are subject to change without notice. All shipping and special processing charges are additional.

US Retail Price List - August 2016

Pattern	Repeat	Width	Price	UOM	Grade	Pattern	Repeat	Width	Price	UOM	Grade
33665		55"	78.90	YARD	13	33750	26"	53"	177.00	YARD	
33666	4 1/2"	58"	139.00	YARD	23	33754	15 1/2"	51"	177.00	YARD	37
33667	4 1/2"	1/2"	139.00	YARD	21	33756	3"	51"	169.00	YARD	
33668	2"	1/2"	119.00	YARD	17	33757	6 1/2"	52"	157.00	YARD	
33670	2"	1/2"	149.00	YARD	22	33758	15"	52"	248.00	YARD	
33671	1"	1/2"	149.00	YARD	25	33759	13"	53"	129.00	YARD	
33672	4"	1/2"	179.00	YARD	24	33760	8"	52"	177.00	YARD	33
33673	4"	1/2"	149.00	YARD	22	33761	15"	52"	169.00	YARD	
33674	2"	1/2"	119.00	YARD	17	33763	1"	52"	199.00	YARD	26
33675		55"	49.00	YARD	9	33765		53"	54.90	YARD	13
33677	2"	1/2"	149.00	YARD	22	33766		55"	59.90	YARD	19
33678	4"	1/2"	179.00	YARD	24	33767		55"	109.90	YARD	28
33679	1"	1/2"	149.00	YARD	25	33769		55"	59.90	YARD	17
33680	27"	1/2"	298.00	YARD	54	33770		58"	99.90	YARD	23
33681	4"	1/2"	149.00	YARD	22	33771		54"	71.90	YARD	16
33682	28 1/2"	57"	129.00	YARD	19	33772	10 1/2"	54"	177.00	YARD	
33683	30 1/2"	56"	197.00	YARD	34	33773		54"	91.90	YARD	20
33684	17"	55"	298.00	YARD	46	33774		57"	95.90	YARD	22
33686	3"	55"	298.00	YARD	45	33775		57"	95.90	YARD	22
33687	10"	55"	248.00	YARD	39	33777		1/2"	248.00	YARD	
33688		55"	197.00	YARD	20	33778		54"	89.90	YARD	20
33691		55"	177.00	YARD		33779		53"	119.00	YARD	16
33692		51"	396.00	YARD	44	33780	7"	56"	79.80	YARD	8
33693		55"	396.00	YARD	50	33781	7"	56"	69.80	YARD	6
33695		1/2"	159.00	YARD	21	33782	13"	54"	199.00	YARD	22
33696		55"	159.00	YARD	16	33783	2"	1/2"	199.00	YARD	21
33697		51"	248.00	YARD	25	33784	15 1/2"	53"	199.00	YARD	34
33698	5 1/2"	54"	159.00	YARD	16	33785		54"	99.00	YARD	8
33699		54"	199.00	YARD		33786	19"	54"	99.00	YARD	10
33700	1"	54"	179.00	YARD		33787	2"	54"	179.00	YARD	26
33701		54"	199.00	YARD	27	33788		57"	59.00	YARD	6
33702		1/2"	197.00	YARD	21	33789		54"	59.80	YARD	6
33703	7 1/2"	52"	270.00	YARD		33790	13 1/2"	55"	169.00	YARD	22
33705		53"	177.00	YARD	20	33791	15 1/2"	50"	248.00	YARD	46
33706	7"	1/2"	248.00	YARD		33792		54"	149.00	YARD	
33707		55"	330.00	YARD		33793	4"	54"	199.00	YARD	24
33708		62"	145.90	YARD		33794	6 1/2"	51"	199.00	YARD	31
33711	15 1/2"	1/2"	169.00	YARD		33795	23"	51"	298.00	YARD	49
33712	14"	1/2"	199.00	YARD		33796	15"	54"	270.00	YARD	
33713		62"	89.90	YARD		33797	42"	54"	119.00	YARD	
33715		62"	85.90	YARD		33798	18 1/2"	54"	119.00	YARD	16
33718		54"	41.90	YARD	11	33799	20 1/2"	54"	197.00	YARD	26
33720		54"	69.00	YARD	20	33800	4 1/2"	1/2"	250.00	YARD	31
33723		62"	199.90	YARD		33803	28"	54"	248.00	YARD	
33725		54"	89.90	YARD	25	33804		50"	197.00	YARD	25
33726		62"	113.90	YARD		33806		54"	139.00	YARD	15
33728	1 1/2"	55"	169.00	YARD		33807	11"	54"	169.00	YARD	18
33730	20 1/2"	55"	189.00	YARD		33808		53"	157.00	YARD	26
33732		55"	298.00	YARD	33	33809	4"	53"	290.00	YARD	45
33733	13 1/2"	54"	197.00	YARD		33810	4"	1/2"	177.00	YARD	29
33734	14"	54"	197.00	YARD		33811		57"	179.00	YARD	27
33736	5"	56"	69.00	YARD	10	33812	14"	57"	177.00	YARD	22
33738	13"	50"	248.00	YARD		33813	12 1/2"	1/2"	149.00	YARD	21
33740	10"	50"	149.00	YARD		33814	19"	54"	199.00	YARD	36
33741	16 1/2"	1/2"	296.00	YARD		33815		55"	179.90	YARD	23
33742	7 1/2"	50"	197.00	YARD		33816		54"	179.00	YARD	41
33743		50"	149.00	YARD		33817	18"	1/2"	119.00	YARD	13
33744	8"	50"	197.60	YARD		33819	26 1/4"	55"	129.00	YARD	
33745	8"	50"	236.00	YARD		33820	24"	54"	298.00	YARD	
33746	7 1/2"	50"	169.00	YARD	32	33822		54"	77.00	YARD	16
33747	16"	50"	129.00	YARD		33823		54"	77.00	YARD	15
33748	7 1/2"	50"	199.00	YARD	38	33824		54"	79.00	YARD	16
33749	8"	50"	177.00	YARD	34	33825		54"	77.00	YARD	16

Prices herein quoted are suggested retail. Prices are subject to change without notice. All shipping and special processing charges are additional.

US Retail Price List - August 2016

Pattern	Repeat	Width	Price	UOM	Grade	Pattern	Repeat	Width	Price	UOM	Grade
33826		54"	99.80	YARD	19	33907		1/2"	197.60	YARD	29
33827		53"	79.00	YARD	16	33908		54"	790.00	YARD	
33828		55"	69.00	YARD	16	33909	16"	50"	296.00	YARD	42
33829		55"	89.80	YARD	18	33910		55"	177.00	YARD	23
33831		55"	99.00	YARD	5	33912	11 1/2"	58"	270.00	YARD	36
33832	5 1/2"	55"	99.00	YARD	5	33913		56"	176.00	YARD	23
33834	13 1/2"	1/2"	68.90	YARD	17	33914	4"	50"	189.00	YARD	31
33836		56"	55.00	YARD	5	33915		1/2"	197.00	YARD	23
33837		1/2"	348.00	YARD		33916	31"	51"	396.00	YARD	78
33838		53"	43.90	YARD	12	33917	1 1/2"	51"	230.00	YARD	33
33839	30 1/2"	52"	298.00	YARD		33918		55"	248.00	YARD	32
33840		55"	77.00	YARD	16	33919		51"	220.00	YARD	35
33842		54"	59.90	YARD	14	33920		55"	328.00	YARD	38
33846	10"	55"	129.00	YARD		33921	12"	52"	248.00	YARD	
33849	8"	54"	199.00	YARD		33922	5"	54"	199.00	YARD	27
33850	27 1/2"	54"	248.00	YARD		33923	26"	50"	290.00	YARD	43
33851		55"	179.90	YARD	23	33924		1/2"	79.80	YARD	15
33852		55"	179.90	YARD	23	33925		55"	149.00	YARD	25
33853	11"	54"	149.00	YARD	21	33926	7"	50"	248.00	YARD	45
33854	5 1/2"	54"	135.00	YARD	20	33928		55"	159.00	YARD	23
33855	13 1/2"	55"	149.00	YARD	26	33929		55"	199.00	YARD	25
33856	13"	54"	135.00	YARD	20	33930	2 1/2"	55"	99.00	YARD	19
33857	11"	54"	159.80	YARD	21	33931	1"	56"	99.80	YARD	16
33858	11"	54"	149.00	YARD	21	33932		55"	199.00	YARD	25
33859	5 1/2"	54"	135.00	YARD	20	33933	4"	50"	390.00	YARD	62
33861	5 1/2"	1/2"	129.00	YARD	18	33934	2 1/2"	1/2"	99.80	YARD	18
33862	1"	1/2"	99.00	YARD	13	33935		55"	198.00	YARD	
33863	4"	1/2"	129.00	YARD	18	33937	10 1/2"	55"	197.00	YARD	26
33864	5"	56"	119.00	YARD	16	33938	3"	54"	129.00	YARD	14
33866	4 1/2"	59"	99.00	YARD	13	33939	7"	56"	99.80	YARD	18
33867	13"	1/2"	129.00	YARD	22	33940	8 1/2"	57"	99.80	YARD	19
33868	9 1/2"	58"	99.80	YARD	13	33941	4"	1/2"	99.80	YARD	19
33869	20"	1/2"	236.00	YARD	38	33942	7"	55"	99.80	YARD	19
33870		58"	79.00	YARD	8	33943	2"	56"	99.80	YARD	20
33871	13"	54"	135.00	YARD	20	33944	9 1/2"	51"	248.00	YARD	45
33872	11"	54"	159.80	YARD	21	33945	2"	51"	296.00	YARD	51
33873	13 1/2"	55"	149.00	YARD	26	33946	4"	53"	199.00	YARD	32
33874	4 1/2"	59"	99.00	YARD	13	33947	13 1/2"	55"	230.00	YARD	60
33875	5 1/2"	1/2"	129.00	YARD	18	33948	32"	54"	296.00	YARD	50
33876		55"	99.00	YARD	12	33949		55"	298.00	YARD	51
33877	5 1/2"	55"	99.00	YARD	13	33950	7"	55"	348.00	YARD	65
33878		58"	79.00	YARD	8	33952		55"	248.00	YARD	43
33879	13"	1/2"	129.00	YARD	22	33953	3 1/2"	51"	298.00	YARD	75
33880	1"	1/2"	99.00	YARD	13	33954		55"	159.80	YARD	26
33881	4"	1/2"	129.00	YARD	18	33955		55"	248.00	YARD	43
33882	5"	56"	119.00	YARD	16	33956		53"	298.00	YARD	51
33883	9 1/2"	58"	99.80	YARD	13	33957	25 1/4"	50"	298.00	YARD	
33885	12 1/2"	58"	197.00	YARD		33958	14 1/2"	1/2"	197.00	YARD	49
33886		55"	157.00	YARD	33	33960	6 1/2"	55"	149.00	YARD	36
33887		55"	59.80	YARD	9	33961	15 1/2"	55"	169.00	YARD	40
33889	7"	56"	59.80	YARD	7	33963	10"	53"	199.00	YARD	46
33890	3 1/2"	56"	59.80	YARD	7	33964	44"	55"	270.00	YARD	74
33891	3 1/2"	56"	59.80	YARD	9	33965	50"	52"	230.00	YARD	70
33892	12 1/2"	53"	129.00	YARD	18	33966	28 3/4"	54"	199.00	YARD	51
33893	1 1/2"	54"	119.00	YARD	15	33968		1/2"	169.00	YARD	35
33894	27 1/2"	1/2"	119.00	YARD		33970	19"	55"	248.00	YARD	57
33895		54"	79.80	YARD	8	33971		55"	149.00	YARD	32
33897	7"	54"	69.80	YARD	7	33972	17 1/2"	53"	230.00	YARD	58
33900	17 1/2"	54"	99.80	YARD	11	33973		1/2"	270.00	YARD	59
33901	3"	58"	119.00	YARD	13	33974	13"	55"	230.00	YARD	57
33902		54"	41.90	YARD	5	33975	13 1/2"	55"	230.00	YARD	55
33904		62"	199.90	YARD		33976	9"	53"	230.00	YARD	62
33905		55"	179.90	YARD	23	33977		55"	179.00	YARD	37

Prices herein quoted are suggested retail. Prices are subject to change without notice. All shipping and special processing charges are additional.

US Retail Price List - August 2016

Pattern	Repeat	Width	Price	UOM	Grade	Pattern	Repeat	Width	Price	UOM	Grade
33979		12"	54"	197.00	YARD	47		55"	99.80	YARD	22
33980	29	1/2"	53"	197.00	YARD			55"	199.00	YARD	30
33981			55"	62.90	YARD	5		54"	179.00	YARD	22
33983			54"	197.00	YARD	40		54"	119.00	YARD	19
33984		34"	55"	230.00	YARD	59		54"	119.80	YARD	20
33985	12	1/2"	53"	248.00	YARD	68		54"	118.00	YARD	15
33986			55"	169.00	YARD	34		55"	248.00	YARD	47
33987	16	1/2"	54"	248.00	YARD	54		12"	54"	169.00	YARD
33988			55"	177.00	YARD	34		21"	54"	189.00	YARD
33990			55"	197.00	YARD	38		1"	54"	73.90	YARD
33991			55"	119.00	YARD	25		4"	54"	63.90	YARD
33992	24	1/2"	54"	290.00	YARD	71		54"	73.90	YARD	18
33994		18"	54"	290.00	YARD	79		55"	284.00	YARD	49
33996		26"	53"	149.00	YARD	41		55"	199.00	YARD	33
33999		5"	1/2"	189.00	YARD	48		54"	73.90	YARD	16
34000		5"	1/2"	197.00	YARD	48		55"	99.90	YARD	16
34001		5"	1/2"	159.00	YARD	38		3 1/2"	54"	73.90	YARD
34002		36"	54"	199.00	YARD	52		55"	177.00	YARD	34
34003		12"	53"	248.00	YARD	54		54"	73.90	YARD	18
34004	27	1/2"	55"	448.00	YARD			54"	62.90	YARD	14
34005	13	1/2"	1/2"	99.00	YARD	14		54"	159.00	YARD	22
34006		23"	51"	390.00	YARD			9"	54"	73.50	YARD
34007		22"	51"	336.00	YARD			50"	199.00	YARD	38
34008		3"	1/2"	177.00	YARD	37		54"	62.90	YARD	12
34009	19	1/2"	52"	177.00	YARD			54"	159.00	YARD	19
34010	30	1/2"	52"	177.00	YARD			50"	248.00	YARD	47
34011	22	1/2"	50"	290.00	YARD			12 1/2"	53"	77.00	YARD
34012		21"	57"	248.00	YARD			53"	159.00	YARD	36
34014			55"	248.00	YARD	31		54"	74.90	YARD	17
34015			55"	177.00	YARD			54"	139.80	YARD	25
34019	16	1/2"	55"	159.00	YARD			12 1/2"	55"	159.00	YARD
34020	22	1/2"	55"	298.00	YARD			33"	52"	248.00	YARD
34021		14"	53"	248.00	YARD	42		54"	159.00	YARD	26
34022	18	1/2"	54"	348.00	YARD			55"	177.00	YARD	31
34025		15"	49"	197.00	YARD	51		55"	199.00	YARD	38
34026			55"	398.00	YARD			13 1/2"	1/2"	119.00	YARD
34028			55"	236.00	YARD			54"	199.00	YARD	41
34029		10"	50"	298.00	YARD			54"	159.00	YARD	28
34030			50"	298.00	YARD	41		53"	264.00	YARD	30
34031		5"	54"	398.00	YARD	52		54"	57.90	YARD	15
34032			55"	290.00	YARD	30		1 1/2"	55"	129.00	YARD
34033		22"	55"	296.00	YARD	71		21 1/2"	55"	129.00	YARD
34034		5"	55"	199.00	YARD	26		14 1/2"	56"	157.00	YARD
34035		15"	55"	270.00	YARD	38		54"	99.80	YARD	15
34036		16"	55"	298.00	YARD			55"	148.00	YARD	22
34038	13	1/2"	1/2"	490.00	YARD			5"	56"	99.80	YARD
34040		59"	53"	248.00	YARD			59"	129.00	YARD	
34041		7"	54"	348.00	YARD			4 1/2"	58"	119.80	YARD
34042	24	1/2"	57"	119.00	YARD	13		28"	59"	89.90	YARD
34044			56"	59.80	YARD	11		8 1/2"	55"	119.00	YARD
34047		12"	1/2"	169.00	YARD	33		14"	54"	99.80	YARD
34048		14"	54"	290.00	YARD			54"	99.80	YARD	16
34049			1/2"	69.80	YARD	9		55"	117.00	YARD	25
34050			1/2"	79.80	YARD	7		54"	79.80	YARD	10
34051	3	1/2"	54"	109.00	YARD	14		55"	99.00	YARD	16
34053	31	1/2"	51"	270.00	YARD			54"	99.80	YARD	14
34054			54"	169.00	YARD	37		54"	49.90	YARD	11
34055			54"	169.00	YARD	32		12"	50"	149.00	YARD
34056		35"	1/2"	196.00	YARD			58"	119.90	YARD	19
34057		13"	1/2"	119.80	YARD	18		8"	54"	99.80	YARD
34062			54"	129.00	YARD	17		54"	115.00	YARD	19
34063			58"	59.00	YARD	15		7 1/2"	50"	139.00	YARD
34065			54"	129.00	YARD	27		10"	54"	115.00	YARD

Prices herein quoted are suggested retail. Prices are subject to change without notice. All shipping and special processing charges are additional.

US Retail Price List - August 2016

Pattern	Repeat	Width	Price	UOM	Grade	Pattern	Repeat	Width	Price	UOM	Grade			
34141		14"	54"	149.00	YARD	31 34217		3"	55"	111.90	YARD	33		
34142			54"	149.00	YARD	30 34218	14	1/2"	54"	53.90	YARD	13		
34144	26	1/2"	54"	177.00	YARD	43 34219			54"	92.90	YARD	20		
34145		7"	54"	119.00	YARD	17 34221			54"	99.00	YARD	21		
34146		13"	57"	149.00	YARD	22 34222			54"	159.00	YARD	22		
34147			55"	179.90	YARD	23 34223			54"	43.90	YARD	8		
34148		7"	54"	139.00	YARD	21 34225	15	1/2"	1/2"	276.00	YARD			
34149	17	1/2"	54"	149.00	YARD	34234		3"	54"	149.00	YARD	26		
34150	21	1/2"	54"	119.00	YARD	25 34235			54"	149.00	YARD	26		
34154		23"	54"	169.00	YARD	36 34236			54"	199.00	YARD	30		
34155		9"	50"	119.00	YARD	25 34237			54"	790.00	YARD			
34156	5	1/2"	54"	119.00	YARD	21 34238			54"	139.00	YARD	24		
34157	6	1/2"	1/2"	79.80	YARD	15 34239	5"		54"	398.00	YARD	53		
34158	15	1/2"	50"	248.00	YARD	57 34247			1/2"	197.00	YARD	34		
34160		13"	54"	129.00	YARD	26 34274	3"		54"	199.00	YARD	27		
34161	24	1/2"	54"	149.00	YARD	24 34397			54"	89.80	YARD	16		
34162		15"	54"	169.00	YARD	24 34534			54"	39.90	YARD	5		
34163	10	1/2"	54"	197.00	YARD	29 34565			55"	41.90	YARD	14		
34164			54"	119.00	YARD	17 34566			54"	62.90	YARD	14		
34165		5"	51"	137.00	YARD	30 3502			118"	149.00	YARD			
34167		15"	50"	169.00	YARD	40 3509			118"	99.80	YARD			
34168			54"	99.00	YARD	3510			2"	59"	149.00	YARD		
34170		23"	55"	177.00	YARD	36 3513			3"	58"	41.90	YARD		
34171		8"	55"	149.00	YARD	27 3514				118"	189.00	YARD		
34172			54"	149.00	YARD	32 3516			16"	53"	149.00	YARD		
34173			54"	89.90	YARD	25 3517			126"	89.00	YARD			
34174			55"	59.90	YARD	14 3518			126"	99.00	YARD			
34175	6	1/2"	54"	149.00	YARD	21 3520			118"	179.00	YARD			
34177	2	1/2"	54"	89.00	YARD	9 3521			4"	52"	396.00	YARD		
34178	13	1/2"	54"	89.00	YARD	9 3522	17	1/2"	51"	41.90	YARD			
34179			54"	137.90	YARD	22 3527			16"	54"	197.00	YARD		
34180			54"	57.90	YARD	11 3528	3	1/2"	51"	149.00	YARD			
34181			54"	57.90	YARD	11 3529			13"	51"	149.00	YARD		
34182			54"	57.90	YARD	10 3530				51"	129.00	YARD		
34183			54"	57.90	YARD	11 3531				53"	97.00	YARD		
34185			54"	57.90	YARD	10 3532	1	1/2"	57"	31.90	YARD			
34186			54"	57.90	YARD	9 3533	2	1/2"	57"	31.90	YARD			
34187			54"	57.90	YARD	11 3535				54"	41.90	YARD		
34188			54"	57.90	YARD	9 3539			4"	53"	99.00	YARD		
34189		6"	57"	99.00	YARD	21 3540	31	1/2"	52"	248.00	YARD			
34190			54"	57.90	YARD	11 3541			3"	59"	195.00	YARD		
34191			56"	59.90	YARD	5 3542				54"	27.90	YARD		
34193			54"	57.90	YARD	10 3543				53"	33.90	YARD		
34194			54"	57.90	YARD	12 3544			16"	52"	129.00	YARD		
34195			55"	169.00	YARD	34 3545			16"	52"	99.00	YARD		
34196			55"	99.80	YARD	22 3546				52"	129.00	YARD		
34197			55"	119.90	YARD	16 3547	21	1/2"	55"	97.00	YARD			
34198		8"	51"	119.00	YARD	27 3548	19	1/2"	51"	109.00	YARD			
34200			53"	248.00	YARD	3549			12"	54"	79.80	YARD		
34201		28"	54"	298.00	YARD	3550			5"	52"	197.00	YARD		
34202		31"	50"	298.00	YARD	3551	1	1/2"	54"	129.00	YARD			
34203		13"	50"	248.00	YARD	3553			23"	54"	129.00	YARD		
34204		14"	1/2"	129.00	YARD	3554	15	1/2"	54"	149.00	YARD			
34205			54"	113.90	YARD	18 3557			3	1/2"	59"	197.00	YARD	
34206		11"	56"	41.90	YARD	9 3559			2"	53"	199.00	YARD		
34207		8"	51"	149.00	YARD	31 3560			2"	59"	199.00	YARD		
34208		4"	51"	77.80	YARD	16 3561				53"	128.90	YARD		
34209			55"	64.90	YARD	19 3563				54"	69.90	YARD		
34210		4"	55"	71.90	YARD	16 3564	15	1/2"	48"	298.00	YARD			
34213		4"	52"	85.90	YARD	22 3566			5"	54"	97.00	YARD		
34214		9"	55"	111.90	YARD	25 3568			9	1/2"	118"	97.00	YARD	
34215		6	1/2"	55"	111.90	YARD	28 3569			31	1/2"	52"	316.00	YARD
34216		6	1/2"	55"	111.90	YARD	28 3570			15	1/2"	51"	197.00	YARD

Prices herein quoted are suggested retail. Prices are subject to change without notice. All shipping and special processing charges are additional.

US Retail Price List - August 2016

Pattern	Repeat	Width	Price	UOM	Grade	Pattern	Repeat	Width	Price	UOM	Grade
3572	31	1/2"	52"	296.00	YARD	3674	22	1/2"	1/2"	197.00	YARD
3574	15	1/2"	51"	290.00	YARD	3676	18"	55"	296.00	YARD	
3576		1"	59"	248.00	YARD	3682		118"	85.00	YARD	
3578		1"	59"	270.00	YARD	3683		118"	85.00	YARD	
3580		2"	59"	270.00	YARD	3684		118"	75.00	YARD	
3582			55"	53.00	YARD	3685		110"	129.00	YARD	
3584		3"	52"	103.90	YARD	3686		118"	75.00	YARD	
3586			54"	57.90	YARD	3687		118"	75.00	YARD	
3587	10	1/2"	1/2"	103.90	YARD	3688		118"	95.00	YARD	
3588		1/2"	52"	124.90	YARD	3689		118"	89.80	YARD	
3589		12"	54"	126.90	YARD	3690		116"	44.90	YARD	
3590	10	1/2"	53"	103.50	YARD	3691		118"	54.90	YARD	
3591		6"	54"	98.90	YARD	3692		118"	84.90	YARD	
3592			56"	67.00	YARD	3693		118"	47.90	YARD	
3594		1"	54"	57.90	YARD	3694		118"	99.00	YARD	
3595			54"	107.90	YARD	3695		118"	49.80	YARD	
3596	3	1/2"	56"	57.50	YARD	3696		54"	69.90	YARD	
3602			52"	197.00	YARD	3697		118"	59.00	YARD	
3603	5	1/2"	53"	39.90	YARD	3698		110"	75.00	YARD	
3604		12"	1/2"	39.90	YARD	3699		118"	89.80	YARD	
3605		16"	1/2"	39.90	YARD	3700		118"	78.90	YARD	
3606		12"	51"	49.90	YARD	3701		118"	84.90	YARD	
3607			49"	39.90	YARD	3702		118"	75.00	YARD	
3608			118"	35.90	YARD	3703		118"	42.90	YARD	
3609			110"	55.90	YARD	3704		118"	69.00	YARD	
3610	15	1/2"	51"	49.90	YARD	3705		118"	78.90	YARD	
3611			53"	61.90	YARD	3706		52"	197.00	YARD	
3613	7	1/2"	55"	61.90	YARD	3707		118"	49.80	YARD	
3614		15"	53"	55.90	YARD	3708		1/2"	189.00	YARD	
3616	6	1/2"	59"	35.90	YARD	3711		114"	139.90	YARD	
3618		7"	55"	61.90	YARD	3712		53"	128.90	YARD	
3619			120"	55.90	YARD	3713		118"	32.90	YARD	
3620			59"	27.90	YARD	3714		53"	179.00	YARD	
3621		13"	56"	46.90	YARD	3715		16"	52"	149.00	YARD
3622			60"	27.90	YARD	3716		16"	52"	179.00	YARD
3625			53"	15.90	YARD	3717		32"	55"	348.00	YARD
3626		2"	59"	32.90	YARD	3718		54"	53.00	YARD	16
3628		6"	52"	39.90	YARD	3719		1"	54"	399.00	YARD
3630		16"	1/2"	35.90	YARD	3722	4	1/2"	54"	103.90	YARD
3631	12	1/2"	1/2"	37.90	YARD	3723		6"	54"	84.90	YARD
3632	21	1/2"	59"	40.90	YARD	3725	15	1/2"	50"	169.00	YARD
3633		12"	53"	39.90	YARD	3726		3"	51"	197.00	YARD
3635		15"	55"	61.90	YARD	3727	7	1/2"	52"	149.00	YARD
3636			113"	39.90	YARD	3729	3	1/2"	1/2"	46.90	YARD
3637			113"	39.90	YARD	3730	7	1/2"	54"	41.90	YARD
3638			113"	39.90	YARD	3732		5"	50"	165.00	YARD
3639			113"	39.90	YARD	3739		124"	149.00	YARD	
3640			54"	169.00	YARD	3740		118"	27.90	YARD	
3641			54"	199.00	YARD	3741	3"	118"	27.90	YARD	
3642			55"	177.00	YARD	3742		118"	37.90	YARD	
3643		33"	55"	197.00	YARD	3743		118"	27.90	YARD	
3645			55"	149.00	YARD	3745		118"	46.90	YARD	
3646		19"	55"	220.00	YARD	3746		118"	30.50	YARD	
3647	9	1/2"	55"	119.00	YARD	3747		118"	37.90	YARD	
3648		37"	55"	159.00	YARD	3748		118"	69.90	YARD	
3654		20"	55"	99.80	YARD	3749	4	1/2"	108"	69.90	YARD
3655	15	1/2"	53"	129.00	YARD	3750		118"	51.90	YARD	
3656			55"	149.00	YARD	3751		118"	29.90	YARD	
3657			55"	149.00	YARD	3752		118"	55.90	YARD	
3659		13"	54"	149.00	YARD	3753		118"	32.90	YARD	
3668			54"	248.00	YARD	3754		118"	27.90	YARD	
3669		38"	55"	129.00	YARD	3755		118"	27.90	YARD	
3672		32"	52"	149.00	YARD	3756		118"	46.90	YARD	

Prices herein quoted are suggested retail. Prices are subject to change without notice. All shipping and special processing charges are additional.

US Retail Price List - August 2016

Pattern	Repeat	Width	Price	UOM	Grade	Pattern	Repeat	Width	Price	UOM	Grade
3757		118"	22.90	YARD		3827		124"	248.00	YARD	
3758		118"	65.90	YARD		3828		56"	99.00	YARD	
3759		118"	24.90	YARD		3829		54"	149.00	YARD	
3760	3/4"	118"	55.90	YARD		3838		54"	44.90	YARD	
3761		118"	22.90	YARD		3840		54"	44.90	YARD	
3762		118"	41.90	YARD		3841	5 1/2"	54"	149.00	YARD	
3763		118"	41.90	YARD		3842	15 1/2"	54"	129.00	YARD	
3764		51"	22.90	YARD		3843	12"	54"	79.80	YARD	
3765	4"	53"	47.90	YARD		3844	19"	54"	129.00	YARD	
3766	6"	56"	41.90	YARD		3845	11"	54"	129.00	YARD	
3767		54"	44.90	YARD		3846	12"	54"	75.00	YARD	
3769		54"	37.90	YARD		3847	21 1/2"	54"	149.00	YARD	
3770	12 1/2"	58"	38.90	YARD		3848	28"	54"	169.00	YARD	
3771		54"	61.90	YARD		3849	28"	54"	169.00	YARD	
3772		58"	37.90	YARD		3849-A	29"	55"	350.00	YARD	55
3773	10 1/2"	56"	41.90	YARD		3850	21 1/2"	54"	149.00	YARD	
3774	6"	1/2"	47.90	YARD		3851	5 1/2"	54"	149.00	YARD	
3775	3"	1/2"	47.90	YARD		3852	11"	54"	129.00	YARD	
3776		58"	32.90	YARD		3853	15 1/2"	54"	129.00	YARD	
3777		54"	32.90	YARD		3854	19"	54"	129.00	YARD	
3778		118"	29.50	YARD		3855	12"	54"	75.00	YARD	
3779		60"	27.90	YARD		3856	12"	54"	79.80	YARD	
3782		118"	13.90	YARD		3857	23"	54"	129.00	YARD	
3783		54"	27.90	YARD		3858	15 1/2"	54"	149.00	YARD	
3784		118"	55.90	YARD		3859	29"	55"	350.00	YARD	55
3785		60"	27.90	YARD		3861		58"	49.00	YARD	
3786		54"	39.90	YARD		3863	16"	52"	296.00	YARD	
3787		118"	65.90	YARD		3864	1 1/2"	52"	177.00	YARD	
3788		54"	32.90	YARD		3865	17"	52"	159.00	YARD	
3789		54"	37.90	YARD		3866		53"	189.00	YARD	
3790	3"	52"	69.90	YARD		3867		53"	128.90	YARD	
3791		54"	38.90	YARD		3868		53"	145.00	YARD	
3792	5"	1/2"	74.90	YARD		3869	16"	52"	179.00	YARD	
3793		54"	38.90	YARD		3871		55"	69.90	YARD	
3795	3 1/2"	60"	32.90	YARD		3872		114"	169.90	YARD	
3796	1 1/2"	60"	27.90	YARD		3873		55"	53.90	YARD	
3797		55"	73.80	YARD		3874		110"	91.90	YARD	
3798		57"	57.00	YARD		3875		118"	37.00	YARD	
3800		56"	41.90	YARD		3876	5"	118"	71.80	YARD	
3801		54"	32.90	YARD		3877	9 7/8"	118"	65.00	YARD	
3802	13"	56"	41.90	YARD		3878		118"	37.00	YARD	
3803		58"	49.00	YARD		3879	13 3/4"	118"	79.80	YARD	
3804		55"	79.80	YARD	15	3880	4 3/8"	118"	75.00	YARD	
3805		54"	57.00	YARD	15	3881	1 1/4"	118"	69.00	YARD	
3806		57"	47.00	YARD	11	3882		118"	37.00	YARD	
3807		54"	59.90	YARD	13	3883	5 1/8"	118"	71.80	YARD	
3808		54"	59.90	YARD	14	3884	1/2"	118"	45.00	YARD	
3809		54"	59.90	YARD	14	3885	1/2"	118"	45.00	YARD	
3810		54"	34.90	YARD		3886		118"	47.00	YARD	
3812	1"	59"	296.00	YARD		3887		118"	65.00	YARD	
3813		54"	149.00	YARD		3888	3 7/8"	118"	49.00	YARD	
3815	30"	1/2"	129.00	YARD		3889	54 3/4"	118"	53.00	YARD	
3816	17 1/2"	50"	159.00	YARD		3890	3 7/8"	118"	75.00	YARD	
3817	6"	48"	139.00	YARD		3891	13"	118"	71.80	YARD	
3818	5"	48"	298.00	YARD		3892	1 1/4"	118"	57.00	YARD	
3819	31 1/2"	54"	298.00	YARD		3893		118"	37.00	YARD	
3820		48"	99.00	YARD		3894		118"	57.00	YARD	
3821	31 1/2"	51"	296.00	YARD		3895	7"	118"	65.00	YARD	
3822		52"	159.00	YARD		3896	3 1/2"	118"	55.80	YARD	
3823	4 1/2"	129"	119.00	YARD		3897	1 1/2"	118"	65.00	YARD	
3824	26"	52"	296.00	YARD		3898	7"	118"	65.00	YARD	
3825	11"	110"	199.00	YARD		3899	1 1/2"	118"	57.00	YARD	
3826	3"	110"	179.00	YARD		3900	1/2"	118"	45.00	YARD	

Prices herein quoted are suggested retail. Prices are subject to change without notice. All shipping and special processing charges are additional.

US Retail Price List - August 2016

Pattern	Repeat	Width	Price	UOM	Grade	Pattern	Repeat	Width	Price	UOM	Grade
3901	3	7/8"	118"	55.80	YARD	3970	5"	51"	396.00	YARD	
3902	2	1/8"	118"	49.00	YARD	3971	13"	52"	197.00	YARD	
3903		4"	118"	71.80	YARD	3972		1/2"	198.00	YARD	
3904			118"	45.00	YARD	3973		52"	199.00	YARD	
3905			118"	37.00	YARD	3974		59"	396.00	YARD	
3906		1/4"	118"	45.00	YARD	3975	15	1/2"	52"	149.00	YARD
3907			118"	45.00	YARD	3976		1/2"	256.00	YARD	
3908	54	3/4"	118"	53.00	YARD	3977		117"	135.00	YARD	
3909		5"	118"	65.00	YARD	3978		1"	50"	169.00	YARD
3910			118"	37.00	YARD	3979		50"	236.00	YARD	
3911			118"	65.00	YARD	3980		2"	50"	236.00	YARD
3912	4	7/8"	118"	57.00	YARD	3981		1"	50"	248.00	YARD
3913			118"	37.00	YARD	3982	15	1/2"	51"	129.00	YARD
3914			108"	59.90	YARD	3983	12	1/2"	1/2"	328.00	YARD
3915			54"	37.90	YARD	3984	32	1/2"	1/2"	328.00	YARD
3916		27"	116"	179.00	YARD	3985		1"	1/2"	197.00	YARD
3917		2"	55"	248.00	YARD	3986	31	1/2"	55"	248.00	YARD
3918		6"	50"	199.00	YARD	3987		59"	248.00	YARD	
3920		4"	50"	195.00	YARD	3988		1/2"	197.00	YARD	
3922			59"	45.90	YARD	3989		24"	52"	396.00	YARD
3923	9	1/2"	118"	59.90	YARD	3990	15	1/2"	1/2"	169.00	YARD
3924			54"	119.00	YARD	3991	8	1/2"	1/2"	296.00	YARD
3925			53"	197.00	YARD	3993		57"	129.00	YARD	
3927			54"	189.00	YARD	3996	29	1/2"	130"	270.00	YARD
3928	31	1/2"	50"	230.00	YARD	3998		27"	1/2"	248.00	YARD
3929		4"	118"	69.90	YARD	3999		14"	1/2"	248.00	YARD
3931		23"	118"	69.90	YARD	4000		12"	1/2"	248.00	YARD
3932		4"	50"	145.00	YARD	4003		50"	149.00	YARD	
3933		4"	50"	177.00	YARD	4004		15"	50"	149.00	YARD
3935		15"	55"	129.00	YARD	4005		50"	236.00	YARD	
3936		5"	59"	74.90	YARD	4006		1/2"	197.00	YARD	
3937			118"	59.90	YARD	4007	15	1/2"	49"	298.00	YARD
3938		3"	106"	46.90	YARD	4008		31"	1/2"	350.00	YARD
3939			118"	75.90	YARD	4009		32"	50"	248.00	YARD
3940		2"	116"	89.90	YARD	4010		6"	50"	199.00	YARD
3941		12"	118"	71.90	YARD	4011		29"	49"	330.00	YARD
3942			118"	59.90	YARD	4012	12	1/2"	52"	199.00	YARD
3943	31	1/2"	51"	248.00	YARD	4013		16"	1/2"	296.00	YARD
3944		3"	116"	37.90	YARD	4016		6"	116"	197.00	YARD
3945		1"	114"	37.90	YARD	4017		116"	177.00	YARD	
3946			118"	46.90	YARD	4018		116"	159.00	YARD	
3947		17"	118"	57.90	YARD	4019	3	1/2"	116"	139.00	YARD
3948		22"	118"	149.00	YARD	4020		7"	116"	177.00	YARD
3949		30"	53"	129.00	YARD	4022		1/2"	116"	169.00	YARD
3950	6	1/2"	52"	119.00	YARD	4023		8"	116"	197.00	YARD
3951			122"	316.00	YARD	4024		12"	116"	109.00	YARD
3952			122"	336.00	YARD	4026		2"	116"	189.00	YARD
3953			117"	296.00	YARD	4027	1	1/2"	116"	169.00	YARD
3954	23	1/2"	52"	396.00	YARD	4029	6	1/2"	116"	197.00	YARD
3955		12"	51"	248.00	YARD	4031		116"	159.00	YARD	
3957		6"	54"	115.00	YARD	4032		116"	149.00	YARD	
3958		4"	54"	99.80	YARD	4033	1	1/2"	116"	179.00	YARD
3959		31"	54"	115.00	YARD	4034		116"	159.00	YARD	
3960		4"	54"	99.80	YARD	4037		4"	116"	197.00	YARD
3961		22"	54"	115.00	YARD	4038		116"	149.00	YARD	
3962	8	1/2"	54"	115.00	YARD	4039		116"	149.00	YARD	
3963		7"	54"	115.00	YARD	4040		116"	197.00	YARD	
3964		9"	54"	99.80	YARD	4043	10	1/2"	116"	199.00	YARD
3965	5	1/2"	1/2"	248.00	YARD	4044		116"	159.00	YARD	
3966	7	1/2"	54"	197.00	YARD	4045		9"	116"	119.00	YARD
3967	7	1/2"	52"	284.00	YARD	4046	5	1/2"	116"	135.00	YARD
3968	2	1/2"	59"	139.00	YARD	4047		1"	116"	169.00	YARD
3969			54"	197.00	YARD	4048		116"	135.00	YARD	

Prices herein quoted are suggested retail. Prices are subject to change without notice. All shipping and special processing charges are additional.

US Retail Price List - August 2016

Pattern	Repeat	Width	Price	UOM	Grade	Pattern	Repeat	Width	Price	UOM	Grade
4049	9	1 1/2"	52"	107.90	YARD	4114		118"	93.90	YARD	
4050		4"	53"	107.90	YARD	4115	4"	118"	73.90	YARD	
4051		2"	52"	107.90	YARD	4116		118"	59.90	YARD	
4052			54"	48.90	YARD	4117	9 1/2"	118"	79.90	YARD	
4053	1	1 1/2"	54"	63.90	YARD	4118		118"	59.90	YARD	
4054		9"	53"	111.90	YARD	4119	1 1/2"	118"	97.90	YARD	
4055	6	1 1/2"	54"	68.90	YARD	4120	21"	118"	59.90	YARD	
4056	6	1 1/2"	54"	68.90	YARD	4121	7"	118"	63.90	YARD	
4057	6	1 1/2"	54"	67.90	YARD	4122		118"	59.90	YARD	
4058			54"	82.90	YARD	4123	8"	118"	69.90	YARD	
4059		10"	52"	107.90	YARD	4124	7 1/2"	118"	97.90	YARD	
4060	15	1 1/2"	53"	111.90	YARD	4125		118"	49.90	YARD	
4061			54"	48.90	YARD	4126		118"	93.90	YARD	
4062		3"	54"	63.90	YARD	4127	12"	118"	79.90	YARD	
4063			54"	61.90	YARD	4128	5"	118"	87.90	YARD	
4064			54"	57.90	YARD	4129		118"	69.90	YARD	
4065		4"	53"	107.90	YARD	4130		118"	63.90	YARD	
4066		1"	54"	53.90	YARD	4131	8 1/2"	118"	73.90	YARD	
4067	6	1 1/2"	54"	53.90	YARD	4132		118"	83.90	YARD	
4068	2	1 1/2"	54"	91.90	YARD	4133	1 1/2"	118"	69.90	YARD	
4069		13"	52"	290.00	YARD	4134		118"	69.90	YARD	
4070			1/2"	59.90	YARD	4135	4"	118"	59.90	YARD	
4071		12"	118"	99.80	YARD	4136		58"	49.00	YARD	
4072		13"	51"	69.80	YARD	4137	25 1/2"	118"	63.90	YARD	
4074		3"	52"	270.00	YARD	4138		118"	69.90	YARD	
4075		4"	51"	177.00	YARD	4139	1 1/2"	118"	69.90	YARD	
4076		5"	116"	177.00	YARD	4140	7 1/2"	118"	97.90	YARD	
4077	2	1 1/2"	52"	298.00	YARD	4141	4"	118"	59.90	YARD	
4078	3	1 1/2"	51"	248.00	YARD	4142		118"	93.90	YARD	
4079	36	1 1/2"	1 1/2"	248.00	YARD	4143	5"	118"	87.90	YARD	
4080			55"	177.00	YARD	4144	12"	118"	79.90	YARD	
4081	39	3/4"	55"	189.00	YARD	4145		118"	83.90	YARD	
4082		18"	1 1/2"	248.00	YARD	4146	25 1/2"	118"	63.90	YARD	
4083		1"	55"	119.80	YARD	4147	22"	118"	97.90	YARD	
4084		36"	50"	398.00	YARD	4148	13"	118"	87.90	YARD	
4085		20"	55"	199.00	YARD	4149		118"	87.90	YARD	
4086		16"	55"	248.00	YARD	4150		118"	24.90	YARD	
4087		10"	55"	199.00	YARD	4151	11"	118"	97.90	YARD	
4088			55"	157.00	YARD	4153		118"	53.90	YARD	
4089	7	1 1/2"	58"	199.00	YARD	4154	15 1/2"	118"	87.90	YARD	
4090			50"	199.00	YARD	4155		118"	69.90	YARD	
4091		13"	51"	99.00	YARD	4156		118"	41.90	YARD	
4092		39"	122"	298.00	YARD	4157	4"	118"	73.90	YARD	
4093		19"	51"	119.00	YARD	4158		118"	59.90	YARD	
4094	2	1 1/2"	49"	129.00	YARD	4159	12"	1 1/2"	199.00	YARD	
4095		16"	1 1/2"	119.00	YARD	4160	9 1/2"	118"	79.90	YARD	
4096		19"	55"	177.00	YARD	4161		118"	59.90	YARD	
4097		9"	51"	129.00	YARD	4162	1 1/2"	118"	97.90	YARD	
4098			51"	99.00	YARD	4163		118"	93.90	YARD	
4099		2"	51"	99.80	YARD	4164		118"	49.90	YARD	
4101		30"	118"	79.90	YARD	4165	8"	118"	69.90	YARD	
4102	3	1 1/2"	118"	97.90	YARD	4166		118"	59.90	YARD	
4103		22"	118"	97.90	YARD	4167	7"	118"	63.90	YARD	
4104		13"	118"	87.90	YARD	4168	21"	118"	59.90	YARD	
4105			118"	87.90	YARD	4169		118"	24.90	YARD	
4106			118"	24.90	YARD	4170	8 1/2"	118"	73.90	YARD	
4107		11"	118"	97.90	YARD	4171		118"	69.90	YARD	
4108			118"	24.90	YARD	4172		118"	63.90	YARD	
4109			118"	69.90	YARD	4173		118"	69.90	YARD	
4110			118"	53.90	YARD	4174	18 1/2"	53"	350.00	YARD	
4111	15	1 1/2"	118"	87.90	YARD	4175		54"	129.00	YARD	
4112			118"	69.90	YARD	4176	1 1/2"	129"	119.00	YARD	
4113			118"	41.90	YARD	4177	4"	118"	197.00	YARD	

Prices herein quoted are suggested retail. Prices are subject to change without notice. All shipping and special processing charges are additional.

US Retail Price List - August 2016

Pattern	Repeat	Width	Price	UOM	Grade	Pattern	Repeat	Width	Price	UOM	Grade	
4178	15	1/2"	51"	296.00	YARD	8486		54"	69.90	YARD		
4179			1/2"	59.90	YARD	8503		59"	298.00	YARD		
4181	11	1/2"	54"	149.00	YARD	8515	20"	43"	199.00	YARD		
4182	31	1/2"	50"	197.00	YARD	8550	1"	54"	129.00	YARD	25	
4184			1/2"	99.00	YARD	8554	9"	102"	119.00	YARD		
4185	3"	1/2"		119.00	YARD	8555	8	1/2"	118"	79.80	YARD	
4186	5	1/2"	54"	139.00	YARD	8620		54"	49.90	YARD		
4187	6"		50"	149.00	YARD	8645		60"	21.90	YARD		
4188			50"	159.00	YARD	8655	5"	118"	37.50	YARD		
4190	9"		50"	139.00	YARD	8656		118"	29.50	YARD		
4191	13"		51"	69.00	YARD	8673		54"	65.00	YARD		
4192	12"	1/2"		99.80	YARD	8681		57"	39.90	YARD		
4193	5"	1/2"		197.00	YARD	8682	9"	44"	159.00	YARD		
4194	4	1/2"	51"	98.90	YARD	8714		53"	125.90	YARD	26	
4195	3"	1/2"		177.00	YARD	8716		54"	119.90	YARD		
4196	9	1/2"	51"	99.00	YARD	8725	15	1/2"	49"	139.00	YARD	
4197	13"		51"	59.80	YARD	8734		54"	195.00	YARD		
4198			54"	49.00	YARD	8736	11"	59"	220.00	YARD		
4199	23"	122"		129.00	YARD	8738		55"	175.00	YARD		
4200	4"	118"		197.00	YARD	8739		118"	236.00	YARD		
4201	15"		54"	149.00	YARD	8749	25"	52"	197.00	YARD		
4202			53"	33.90	YARD	8757	6"	57"	24.90	YARD		
4203	8"		51"	396.00	YARD	8758	10	1/2"	52"	49.90	YARD	
4205			54"	46.90	YARD	8759		1/2"	39.90	YARD		
4206			52"	149.90	YARD	8767		117"	99.00	YARD		
4208	5"		50"	129.00	YARD	8769	6"	54"	316.00	YARD		
4209			52"	90.50	YARD	8770		54"	159.00	YARD	29	
4210			56"	85.90	YARD	8771	3	1/2"	47"	179.00	YARD	
4211	8"		54"	79.90	YARD	8779		55"	69.80	YARD		
4212	1"		52"	107.90	YARD	8782	6	3/4"	55"	79.00	YARD	
4213			54"	106.50	YARD	8786	2	1/4"	118"	65.90	YARD	
4214	3"		54"	106.50	YARD	8790		118"	17.90	YARD		
4215	4	1/2"	52"	67.90	YARD	8791		118"	23.50	YARD		
4216			59"	41.90	YARD	8796		60"	9.00	YARD		
4217	12	1/2"	1/2"	59.80	YARD	8802	18"	118"	75.00	YARD		
4218			117"	65.90	YARD	8805	4"	49"	47.90	YARD		
4222			118"	199.00	YARD	8806		118"	33.90	YARD		
5170			54"	51.50	YARD	16		54"	49.90	YARD		
60358			1/2"	13.90	YARD	8814	12	1/2"	49"	199.00	YARD	
60370			2"	29.90	YARD	8815		53"	128.90	YARD		
60371			1/2"	9.90	YARD	8817		54"	99.90	YARD		
716BW			54"	85.00	YARD	11		53"	57.00	YARD		
7575			118"	33.00	YARD	8827		53"	169.00	YARD		
7581			118"	39.90	YARD	8830	12	1/2"	53"	179.00	YARD	
7592			118"	59.00	YARD	8835	5"	55"	99.80	YARD		
7695			54"	11.90	YARD	8845	22"	114"	79.00	YARD		
7698			118"	79.00	YARD	8865	27	1/2"	54"	189.00	YARD	
7700	1"		118"	95.00	YARD	8876		55"	264.00	YARD		
7971			51"	33.90	YARD	8883	7	1/2"	53"	220.00	YARD	
8062			53"	139.00	YARD	8884		55"	159.00	YARD		
8113			118"	55.00	YARD	8885	9"	55"	248.00	YARD		
8126			118"	59.80	YARD	8887	12	1/2"	55"	230.00	YARD	
8177			118"	32.90	YARD	8891	1"	55"	157.00	YARD		
8178			118"	15.90	YARD	8894	18	1/2"	56"	177.00	YARD	
8198			118"	115.00	YARD	8895		130"	149.00	YARD		
8200			54"	34.90	YARD	8897	21"	55"	220.00	YARD		
8263	1	3/4"	45"	99.00	YARD	8898	12	1/2"	55"	298.00	YARD	45
8357	14"	120"		85.00	YARD	8902	24"	56"	236.00	YARD		
8421	4"		49"	47.90	YARD	8907		55"	169.00	YARD		
8424			42"	189.00	YARD	8921		54"	199.00	YARD		
8438	28	1/4"	55"	236.00	YARD	48	1	1/2"	51"	216.00	YARD	
8463			54"	159.00	YARD	8933	15"	51"	250.00	YARD		
8466	9"		53"	199.00	YARD	8950		54"	95.00	YARD		

Prices herein quoted are suggested retail. Prices are subject to change without notice. All shipping and special processing charges are additional.

US Retail Price List - August 2016

Pattern	Repeat	Width	Price	UOM	Grade	Pattern	Repeat	Width	Price	UOM	Grade
8952		54"	199.00	YARD		9296		58"	89.80	YARD	17
8957	4"	130"	97.00	YARD		9298		55"	149.00	YARD	33
8963		54"	129.00	YARD		9302	29"	122"	450.00	YARD	
8966		118"	33.00	YARD		9307	15"	118"	220.00	YARD	
8967	10"	118"	139.00	YARD		9309		52"	169.00	YARD	
8972		118"	69.80	YARD		9310		53"	189.00	YARD	
8975		118"	39.90	YARD		9314	18 1/2"	54"	65.90	YARD	
8978		51"	33.90	YARD		9315	12"	50"	348.00	YARD	
8984	2"	41"	95.00	YARD		9316	7"	50"	149.00	YARD	
8991	4"	49"	47.90	YARD		9320	11 1/2"	54"	53.00	YARD	
9005	5"	118"	37.50	YARD		9344	12"	114"	149.00	YARD	
9006		60"	21.90	YARD		9381	6"	118"	149.00	YARD	
9007		118"	29.50	YARD		9384	26 1/2"	54"	179.00	YARD	
9009	18"	118"	75.00	YARD		9386	2 1/2"	50"	177.00	YARD	
9010		54"	65.00	YARD		9411		54"	51.90	YARD	
9016		54"	119.90	YARD		9413		54"	45.90	YARD	
9020	11 1/2"	54"	99.80	YARD		9424		118"	348.00	YARD	
9028		54"	11.90	YARD		9430	4 1/2"	128"	220.00	YARD	
9030	8 1/2"	52"	149.00	YARD		9435		128"	396.00	YARD	
9041		53"	139.00	YARD		9442	2"	118"	316.00	YARD	
9052	7 1/2"	53"	149.00	YARD		9445	7 1/2"	110"	298.00	YARD	
9055	2"	56"	316.00	YARD		9447	7 1/2"	110"	348.00	YARD	
9056	1"	118"	159.00	YARD		9451	7 1/2"	110"	298.00	YARD	
9058	15 1/2"	53"	169.00	YARD		9452		118"	199.00	YARD	
9060		118"	159.00	YARD		9454	10"	57"	119.00	YARD	
9073		54"	189.00	YARD		9455		112"	197.00	YARD	
9086	15 3/4"	54"	129.00	YARD		9462	3"	127"	149.00	YARD	
9089	17 1/2"	54"	199.00	YARD		9464		127"	159.00	YARD	
9096	1"	53"	115.00	YARD		9465		127"	97.00	YARD	
9097	10"	48"	29.90	YARD		9466		116"	149.00	YARD	
9098		54"	24.90	YARD		9479		128"	89.00	YARD	
9099		53"	109.00	YARD		9480	10 1/2"	116"	149.00	YARD	
9104		52"	23.90	YARD		9506	13 1/2"	59"	298.00	YARD	
9105	5 1/2"	59"	57.90	YARD		9511		59"	199.00	YARD	
9106	11 1/2"	52"	49.00	YARD		9515		56"	69.00	YARD	
9107		110"	189.00	YARD		9523		54"	99.90	YARD	
9113		55"	19.90	YARD		9524	5"	54"	199.00	YARD	
9121		51"	270.00	YARD		9526		117"	149.00	YARD	
9156	17"	130"	220.00	YARD		9532		122"	97.00	YARD	
9177		118"	236.00	YARD		9533	6"	53"	197.00	YARD	
9183	19"	60"	169.00	YARD		9535	4 1/2"	54"	169.00	YARD	
9194	9"	54"	119.00	YARD		9536		118"	165.00	YARD	
9200	21"	55"	220.00	YARD	48	9537		53"	189.00	YARD	
9202		54"	97.00	YARD		9538		53"	250.00	YARD	
9203	15 1/2"	51"	197.00	YARD		9539		121"	349.00	YARD	
9214		53"	69.80	YARD		9542		1/2"	236.00	YARD	
9215	1 1/2"	53"	99.00	YARD		9543		116"	189.00	YARD	
9225		54"	159.00	YARD		9544	18 1/2"	54"	290.00	YARD	
9226	9"	54"	119.00	YARD		9546		54"	248.00	YARD	
9230		54"	157.00	YARD		9551	6 1/2"	54"	248.00	YARD	
9231		137"	139.00	YARD		9552		118"	197.00	YARD	
9232		137"	129.00	YARD		9555		60"	197.00	YARD	
9234	8"	54"	149.00	YARD		9561		54"	159.00	YARD	
9239		54"	99.00	YARD		9567	15"	50"	199.00	YARD	
9243		54"	159.00	YARD		9568		55"	149.00	YARD	
9246	71"	67"	298.00	YARD		9570		55"	197.00	YARD	
9256	12 1/2"	51"	248.00	YARD		9573	3"	53"	159.00	YARD	
9261	4"	52"	33.00	YARD		9575	8"	54"	149.00	YARD	
9267	23 1/2"	59"	33.00	YARD		9576		52"	119.00	YARD	
9269	1 1/2"	59"	29.90	YARD		9577		59"	199.00	YARD	
9273	5 1/2"	51"	35.90	YARD		9580	6"	52"	199.00	YARD	
9290		54"	59.80	YARD		9583		53"	165.00	YARD	
9291		54"	49.80	YARD		9585	23"	130"	237.00	YARD	

Prices herein quoted are suggested retail. Prices are subject to change without notice. All shipping and special processing charges are additional.

US Retail Price List - August 2016

Pattern	Repeat	Width	Price	UOM	Grade	Pattern	Repeat	Width	Price	UOM	Grade
9590	1"	1/2"	159.00	YARD		9729		55"	129.00	YARD	
9597		59"	119.00	YARD		9732	16"	55"	139.00	YARD	
9605	3"	59"	195.00	YARD		9734	38"	53"	220.00	YARD	
9610		54"	99.00	YARD		9737	38"	52"	199.00	YARD	
9617	1"	51"	189.00	YARD		9739		35"	54"	179.00	YARD
9618	2"	118"	79.00	YARD		9740	4 1/2"	55"	169.00	YARD	
9621	5 1/2"	118"	65.00	YARD		9742		55"	115.00	YARD	
9623		118"	69.80	YARD		9745	19"	52"	115.00	YARD	
9624	2"	118"	65.00	YARD		9746	8 1/2"	1/2"	220.00	YARD	
9625	9"	114"	59.80	YARD		9748		118"	69.80	YARD	
9627	5"	118"	77.00	YARD		9749		118"	55.00	YARD	
9628	4"	118"	69.80	YARD		9750	27"	118"	77.00	YARD	
9629		118"	65.00	YARD		9752		118"	49.80	YARD	
9630		118"	69.80	YARD		9753		118"	49.80	YARD	
9632		118"	47.00	YARD		9754		118"	59.00	YARD	
9633		118"	75.00	YARD		9759		118"	89.80	YARD	
9634		118"	65.00	YARD		9761		59"	39.80	YARD	
9635		118"	69.80	YARD		9762		118"	49.00	YARD	
9641		114"	39.80	YARD		9766	2"	118"	69.80	YARD	
9644	2 1/2"	114"	63.00	YARD		9767		118"	87.00	YARD	
9645	1 1/2"	114"	39.80	YARD		9769		118"	69.80	YARD	
9647	15 1/2"	48"	199.00	YARD		9770		118"	49.80	YARD	
9650		17"	59.80	YARD		9771		118"	69.80	YARD	
9652	31 1/2"	55"	276.00	YARD		9772		118"	75.00	YARD	
9654		59"	99.00	YARD		9776		118"	69.80	YARD	
9656	6"	57"	32.90	YARD		9777		118"	49.00	YARD	
9658		54"	49.90	YARD		9778	27"	118"	75.00	YARD	
9660		118"	39.90	YARD		9779		54"	43.00	YARD	
9662	1 1/2"	129"	119.00	YARD		9781	12"	1/2"	27.90	YARD	
9666		55"	169.00	YARD		9783	12"	52"	39.90	YARD	
9669		52"	99.00	YARD		9784		118"	69.80	YARD	
9673		54"	97.90	YARD		9787	8"	118"	75.00	YARD	
9684	1"	54"	289.00	YARD		9789		60"	33.00	YARD	
9685		54"	85.00	YARD		9790		3"	53"	47.90	YARD
9686		54"	89.80	YARD		9794	4 1/2"	52"	47.90	YARD	
9687	3 1/2"	54"	84.90	YARD		9795		60"	27.90	YARD	
9688		118"	149.00	YARD		9797		118"	89.80	YARD	
9691		19"	52"	159.00	YARD		9798		118"	31.90	YARD
9692	1 1/2"	54"	99.00	YARD		9799		118"	37.00	YARD	
9695		4"	52"	149.00	YARD		9800		118"	57.00	YARD
9696	7 1/2"	54"	135.00	YARD		9804	10 1/2"	52"	47.90	YARD	
9697	16 1/2"	54"	129.00	YARD		9806		60"	37.90	YARD	
9701		25"	54"	129.00	YARD		9807		60"	27.90	YARD
9702	18 1/2"	54"	129.00	YARD		9809		59"	43.00	YARD	
9703	15 1/2"	54"	139.00	YARD		9810		57"	67.00	YARD	
9704	15 1/2"	54"	139.00	YARD		9812	7 1/2"	54"	139.00	YARD	
9705	7 1/2"	54"	129.00	YARD		9813		3"	52"	99.80	YARD
9707	5 1/2"	54"	129.00	YARD		9814	11 1/2"	49"	99.00	YARD	
9708	3 1/2"	54"	139.00	YARD		9816		118"	49.90	YARD	
9709	17 1/2"	54"	129.00	YARD		9817		110"	41.90	YARD	
9711		25"	54"	129.00	YARD		9818		118"	49.00	YARD
9712	18 1/2"	54"	129.00	YARD		9819		106"	59.80	YARD	
9713	15 1/2"	54"	139.00	YARD		9820		60"	39.80	YARD	
9714	15 1/2"	54"	139.00	YARD		9821		114"	59.80	YARD	
9715	7 1/2"	54"	129.00	YARD		9822		118"	79.90	YARD	
9717	5 1/2"	54"	129.00	YARD		9824		118"	77.00	YARD	
9718	17 1/2"	54"	129.00	YARD		9825	1"	118"	65.00	YARD	
9719	3 1/2"	54"	139.00	YARD		9827		114"	55.00	YARD	
9721	15 1/2"	51"	316.00	YARD		9828		118"	69.90	YARD	
9725		53"	49.00	YARD		9829		118"	59.00	YARD	
9726		54"	69.80	YARD		9830		118"	54.90	YARD	
9727		53"	99.80	YARD		9831	5"	118"	65.00	YARD	
9728		54"	99.80	YARD		9833		118"	39.00	YARD	

Prices herein quoted are suggested retail. Prices are subject to change without notice. All shipping and special processing charges are additional.

US Retail Price List - August 2016

Pattern	Repeat	Width	Price	UOM	Grade	Pattern	Repeat	Width	Price	UOM	Grade
9834		118"	67.00	YARD		9954	4"	120"	139.00	YARD	
9836		56"	38.50	YARD		9957		54"	74.90	YARD	
9838		54"	27.90	YARD		9959	17"	57"	43.90	YARD	
9839		54"	27.90	YARD		9960	18"	57"	42.90	YARD	
9840		54"	27.90	YARD		9961		55"	29.90	YARD	
9841		54"	27.90	YARD		9962		58"	29.90	YARD	
9842		54"	27.90	YARD		9964		125"	149.00	YARD	
9843		54"	27.90	YARD		9965		1/2"	145.00	YARD	
9844		54"	27.90	YARD		9966		1/2"	149.00	YARD	
9845		118"	79.90	YARD		9967	15 1/2"	52"	117.50	YARD	
9846		53"	31.90	YARD		9970		116"	119.00	YARD	
9847		53"	33.90	YARD		9971	10"	115"	77.50	YARD	
9850	3"	55"	77.00	YARD		9972	10"	114"	77.50	YARD	
9854		54"	99.00	YARD		9973	6 3/4"	105"	79.90	YARD	
9855		53"	49.00	YARD		9978		118"	41.90	YARD	
9856	15"	52"	129.00	YARD		9979		118"	31.90	YARD	
9857		114"	41.90	YARD		9981	4"	111"	77.90	YARD	
9858		118"	59.00	YARD		9984		118"	59.90	YARD	
9859	1"	54"	264.00	YARD		9985	1"	59"	199.00	YARD	
9863		118"	41.90	YARD		9986	2 1/2"	59"	197.00	YARD	
9864	6 1/2"	54"	89.00	YARD		9990	2 1/2"	111"	65.90	YARD	
9865	15 1/2"	54"	95.90	YARD		9993	2"	57"	288.00	YARD	
9866		21"	50"	86.50	YARD		9994	2"	59"	197.00	YARD
9868		3"	52"	99.80	YARD		9996	6"	52"	49.80	YARD
9871	2 1/2"	54"	264.00	YARD		9997		118"	129.90	YARD	
9872		18"	55"	264.00	YARD		ABBEY WAY	103"	53"	177.00	YARD
9873	7 1/2"	51"	376.00	YARD		ABILENE		54"	59.90	YARD	9
9876		57"	228.00	YARD		ACACIA	82 1/2"	1/2"	250.00	YARD	
9877		53"	94.90	YARD		ACACIA GRASS		36"	192.00	ROLL	
9878		53"	128.90	YARD		ACARIO		55"	45.90	YARD	5
9879		53"	145.00	YARD		ACCORD		54"	13.90	YARD	
9886		1/2"	98.90	YARD		ACOUSTIC		54"	75.00	YARD	9
9887		1/2"	109.90	YARD		ADARA		56"	47.90	YARD	5
9889	1"	52"	189.00	YARD		ADELPHI	6 3/4"	54"	39.90	YARD	9
9890	13"	52"	199.00	YARD		ADESSO RR	27"	126"	15.00	YARD	
9891		1/2"	197.00	YARD		ADIRAN		55"	45.90	YARD	5
9892	26"	1/2"	197.00	YARD		ADORA		55"	47.90	YARD	5
9903	3"	54"	328.00	YARD		AEROGARME	27"	58"	99.00	YARD	18
9904	17 1/2"	52"	197.00	YARD		AGATI	23 1/2"	53"	276.00	YARD	58
9906		53"	189.00	YARD		AGENA		55"	44.90	YARD	5
9907	2"	128"	179.00	YARD		AIDA	17 1/2"	59"	256.00	YARD	37
9908		54"	199.00	YARD		AJANTA	27"	54"	52.90	YARD	20
9909		54"	169.00	YARD		ALETA		55"	39.90	YARD	5
9910	3"	52"	149.00	YARD		ALI		54"	177.90	YARD	26
9911	1"	53"	236.00	YARD		ALINA		55"	35.90	YARD	5
9919		58"	157.00	YARD		ALKES		55"	42.90	YARD	5
9921	1 1/2"	59"	197.00	YARD		ALLAMANDA	25 1/2"	54"	65.90	YARD	23
9923		118"	159.00	YARD		ALLI	7"	54"	59.90	YARD	10
9924	4 1/2"	55"	179.00	YARD		ALMORA	27"	54"	59.90	YARD	18
9926		59"	298.00	YARD		ALPACA		55"	298.00	YARD	
9928	2"	56"	33.50	YARD		ALTAI	4 1/2"	51"	170.00	YARD	28
9929		54"	33.50	YARD		ALTRIA		55"	37.90	YARD	5
9930		54"	37.90	YARD		ALVERRA	25 1/4"	55"	75.00	YARD	8
9933		56"	33.50	YARD		ALVITA		55"	42.90	YARD	5
9934		56"	33.50	YARD		ALYA	4"	54"	43.90	YARD	5
9935		54"	51.50	YARD		ALZIR	3 1/2"	54"	43.90	YARD	5
9936	7 1/2"	54"	95.90	YARD		AMALFI		1/2"	350.00	YARD	
9940		60"	34.90	YARD		AMANI	6 1/2"	54"	79.80	YARD	10
9942		54"	67.90	YARD		AMAPOLA	27"	54"	79.80	YARD	18
9943		54"	67.90	YARD		AMAYA	9"	54"	27.90	YARD	6
9945	5"	52"	97.00	YARD		AMBAR		122"	456.00	YARD	
9947	6"	118"	149.00	YARD		AMBIANCE/D	26 1/2"	54"	34.90	YARD	5
9953	1"	52"	197.00	YARD		ANABASIS	25 1/2"	54"	76.90	YARD	16

Prices herein quoted are suggested retail. Prices are subject to change without notice. All shipping and special processing charges are additional.

US Retail Price List - August 2016

Pattern	Repeat	Width	Price	UOM	Grade	Pattern	Repeat	Width	Price	UOM	Grade			
ANAK	12	1/2"	55"	71.90	YARD	23	1"	54"	43.90	YARD	5			
ANDERSON STR			1/2"	58.00	ROLL		10"	54"	199.00	YARD	30			
ANI			54"	27.90	YARD	5		55"	39.90	YARD	5			
ANIMALIKAT	27"	1/2"	99.80	YARD	15		29"	122"	348.00	YARD				
ANJA			54"	59.90	YARD	9		55"	45.90	YARD	5			
ANKORA	9	1/2"	54"	85.00	YARD	11	6	1/2"	54"	79.00	YARD	10		
ANTIQUE			36"	54"	270.00	YARD	40		54"	73.80	YARD	12		
ANTLIA			2"	54"	43.90	YARD	5		54"	76.90	YARD	22		
ANTON	4	1/2"	1/2"	99.00	YARD	14		25	1/2"	52"	248.00	YARD	46	
ANTONY/D			18"	54"	34.90	YARD	5		54"	47.00	YARD	5		
ANVIL			25"	54"	197.00	YARD	29		56"	47.90	YARD	9		
AOMORI			16"	58"	220.00	YARD			55"	47.90	YARD	5		
APOLO	16	1/2"	1/2"	370.00	YARD				55"	37.90	YARD	5		
ARATA			54"	99.00	YARD	5		27"	54"	39.90	YARD	5		
ARBORETA			9"	54"	82.90	YARD	20		54"	45.00	YARD	5		
ARCHES	12	1/2"	54"	99.80	YARD	16		27	1/2"	55"	350.00	YARD	61	
ARGENTO			54"	159.90	YARD	23			54"	48.90	YARD	5		
ARISTOCRAT			28"	54"	398.00	YARD		16"	54"	76.90	YARD	16		
ARMINA			55"	47.90	YARD	5			54"	27.90	YARD	5		
ARNOLD/D			1/2"	54"	33.90	YARD	5		54"	59.90	YARD	7		
ARTA	13	1/2"	1/2"	99.80	YARD	20		5"	58"	84.90	YARD	19		
ARTFUL AWE			28"	55"	169.00	YARD	44		34"	51"	179.00	YARD	39	
ARTFUL LUX			28"	58"	159.80	YARD	37		1/2"	98.00	YARD			
ARTISANAL			54"	137.90	YARD				54"	59.90	YARD	9		
ASCOT			55"	176.00	YARD	36		27"	54"	52.90	YARD	20		
ASTRIA			55"	42.90	YARD	5			55"	198.00	YARD			
ATIK			55"	45.90	YARD	5		27"	55"	99.80	YARD	23		
ATLANTIS			55"	248.00	YARD			17"	58"	196.00	YARD			
ATOMIC			14"	54"	59.90	YARD	9		54"	79.80	YARD	10		
ATRIA			54"	59.90	YARD	7		2"	54"	43.90	YARD	5		
AUDAZ			25"	54"	67.90	YARD			18"	1/2"	99.00	YARD	20	
AUDUBON			53"	198.00	YARD			35"	55"	390.00	YARD	56		
AUGUSTROSE	13	1/2"	54"	59.00	YARD	12		15	1/2"	118"	250.00	YARD		
AUMONT			27"	54"	89.00	YARD	8		18"	54"	77.00	YARD	5	
AURORA			116"	118.00	YARD	14			25"	54"	39.90	YARD	5	
AVADI			25"	54"	79.90	YARD	23		5	1/2"	55"	119.00	YARD	16
AVANASH			27"	54"	137.00	YARD	24			53"	236.00	YARD		
AVENTINE			27"	54"	79.00	YARD		13	1/2"	1/2"	99.80	YARD	20	
AVIKAR	13	1/2"	54"	113.00	YARD	23		13"	55"	179.00	YARD	21		
AWNING/D			54"	29.00	YARD	5			55"	42.90	YARD	5		
AYRSHIRE	25	1/4"	54"	74.90	YARD	27			55"	45.90	YARD	5		
AZELIA			54"	27.90	YARD	5		27"	55"	99.80	YARD	22		
AZIZA			54"	37.90	YARD	5			54"	27.90	YARD	5		
AZTEC			54"	85.00	YARD	10			55"	42.90	YARD	5		
BABYLON			52"	53"	350.00	YARD	36		27"	56"	59.80	YARD		
BABYON			52"	53"	350.00	YARD			55"	45.90	YARD	5		
BACIA			54"	43.90	YARD	5			55"	47.90	YARD	5		
BACULARIA			27"	54"	99.80	YARD	18		54"	59.90	YARD	9		
BAHAMAS			122"	296.00	YARD				55"	44.90	YARD	9		
BAILY			4"	54"	43.90	YARD	5		25	1/4"	1/2"	77.00	YARD	17
BALARA			55"	35.90	YARD	5			18"	54"	99.00	YARD	25	
BALMORAL			25"	54"	350.00	YARD	55		55"	42.90	YARD	5		
BANKU	25	1/2"	54"	47.90	YARD	13		9"	1/2"	89.00	YARD	19		
BANNABA	12	1/2"	54"	59.90	YARD	21			54"	37.90	YARD	5		
BANSURI	25	1/2"	54"	89.00	YARD	21			54"	99.90	YARD	19		
BANTAM	6	3/4"	54"	39.90	YARD	9			26"	54"	185.00	YARD	35	
BARDONHILL			56"	55"	169.00	YARD	30		25	1/4"	54"	79.90	YARD	29
BARODA			32"	55"	298.00	YARD			18"	1/2"	79.00	YARD	15	
BARRYMORE			24"	54"	53.90	YARD	16		13	1/2"	55"	97.00	YARD	19
BATOR	39	1/2"	57"	398.00	YARD				27"	54"	59.80	YARD	5	
BAYA	3	1/2"	54"	43.90	YARD	5			37"	121"	276.00	YARD		
BAYANO	13	1/2"	54"	55.90	YARD	14		1	1/2"	114"	298.00	YARD		
BAYPORT	6	3/4"	54"	39.90	YARD	9		13	1/2"	54"	157.00	YARD		

Prices herein quoted are suggested retail. Prices are subject to change without notice. All shipping and special processing charges are additional.

US Retail Price List - August 2016

Pattern	Repeat	Width	Price	UOM	Grade	Pattern	Repeat	Width	Price	UOM	Grade	
CALVELLO		54"	59.90	YARD	9	CUMULUS	27"	1/2"	99.00	YARD	19	
CAMELLIA/D	35"	54"	29.90	YARD	5	CURAZAO		113"	136.00	YARD		
CAMI		54"	59.90	YARD	9	CURVY	27"	54"	89.00	YARD	16	
CAMPANIA	23	1/2"	121"	350.00	YARD		DAEDALUS	12"	54"	99.80	YARD	15
CANELA	2	1/2"	1/2"	336.00	YARD		DAISYFIELD	27"	54"	99.00	YARD	17
CAP DELUCA		1/2"	79.00	YARD	16	DAKSHA	25"	54"	76.90	YARD	22	
CAPTOWN	6	3/4"	54"	30.90	YARD	7	DALEA	27"	54"	51.90	YARD	19
CAPPARIS		27"	1/2"	99.00	YARD	19	DAMSEFLY	38"	58"	196.00	YARD	
CAPTURED		54"	137.90	YARD	22	DANA	24"	54"	99.80	YARD	16	
CARA		54"	169.90	YARD	24	DARIO		54"	27.90	YARD	7	
CARDARELLI		25"	54"	42.90	YARD	11	DEBUT		54"	137.90	YARD	
CARREY	11	1/2"	52"	199.00	YARD		DEEP SEA		55"	298.00	YARD	40
CARVEL	23	1/2"	54"	37.00	YARD	10	DEIMOS		54"	59.90	YARD	7
CASABELA/D		27"	54"	49.80	YARD	5	DELACROIX	21"	54"	137.00	YARD	34
CASONE/D		18"	55"	79.80	YARD	5	DELANEY		54"	89.80	YARD	10
CASPIAN		54"	59.90	YARD	9	DELICIA	3"	54"	29.90	YARD	8	
CASWELL		54"	79.80	YARD	10	DENTON	44"	54"	177.00	YARD		
CAVALLO	32"	54"	57.90	YARD	22	DEREK		54"	89.80	YARD	10	
CEDAR		122"	296.00	YARD		DERNE		54"	59.90	YARD	13	
CELINE		54"	69.90	YARD	14	DERWIN		54"	59.00	YARD	12	
CERCIE	6	3/4"	55"	59.00	YARD	7	DESI		54"	59.90	YARD	9
CEREN		9"	54"	87.00	YARD	16	DESIRE		54"	127.00	YARD	20
CHAIN RR		18"	118"	99.00	YARD		DETAILS		54"	139.00	YARD	21
CHAMELEON		54"	133.00	YARD	21	DEVINA	27"	1/2"	89.80	YARD		
CHARDIN		36"	1/2"	79.00	YARD	17	DEWDROPS		54"	145.00	YARD	21
CHAVEZ	15	1/2"	54"	159.00	YARD	22	DIEGO	16"	54"	85.00	YARD	13
CHEVAK	11	1/2"	54"	63.90	YARD	18	DILARA	27"	54"	99.80	YARD	23
CHEVIOT		55"	168.00	YARD		DINOTOPIA	3	1/2"	54"	149.00	YARD	22
CHIC FERN	26"	52"	298.00	YARD	59	DIPPER		54"	85.00	YARD	14	
CHIC SLEEK		54"	139.00	YARD	21	DISTORTED	25"	1/2"	89.80	YARD	11	
CHIC WEAVE		54"	199.00	YARD	29	DIVINO	27"	54"	47.90	YARD	19	
CHINA CLUB	18"	1/2"	119.00	YARD	23	DOLLOPS		9"	54"	59.80	YARD	14
CHINA VINE	36"	54"	119.00	YARD	24	DONAHUE	8	1/2"	54"	85.00	YARD	12
CHOPIN/D		54"	29.90	YARD	5	DOTKAT	5	1/2"	1/2"	77.00	YARD	7
CHROMIS	14"	55"	99.80	YARD	14	DOTTIE/D	1	1/2"	54"	33.00	YARD	5
CIELO		54"	157.90	YARD	23	DOUXSUEDE		53"	168.00	YARD	27	
CITRA		54"	197.00	YARD	34	DREAMY VELVET		55"	129.00	YARD		
CITRUS		122"	268.00	YARD		DRESSUR	25"	51"	149.00	YARD	30	
CITY SQUARE	6	1/2"	1/2"	99.80	YARD	17	DREW	25"	54"	33.00	YARD	9
CLASSIC CANVA		54"	45.90	YARD	9	DU PUY	26	1/2"	54"	199.00	YARD	35
CLEMONS/D	27"	54"	39.90	YARD	5	DUANE		54"	59.00	YARD	12	
COBBLE/D	1"	54"	34.90	YARD	5	DUETTE		54"	85.00	YARD	10	
COLORBLOCK	9"	54"	348.00	YARD		DUNCAN		54"	59.80	YARD	12	
COMMOTION		54"	139.00	YARD	21	DUNE		1/2"	470.00	YARD		
CONCHOS		54"	59.90	YARD	9	DURHAM/D		27"	54"	45.00	YARD	5
CONTEMPO	27"	54"	53.90	YARD	21	DUX	25	1/2"	52"	330.00	YARD	
CONTINUUM	9"	1/2"	97.00	YARD	17	DYER	4	1/2"	54"	79.00	YARD	
CORAIL	15"	51"	398.00	YARD		DYLAN		54"	95.00	YARD	13	
CORNERED		54"	163.00	YARD	25	E-33784		16"	54"	199.00	YARD	
CORTEZ/D	36"	54"	49.00	YARD	5	E-33970	15	1/2"	55"	248.00	YARD	
COSMIC/D	36"	54"	39.90	YARD	5	E01010		55"	297.00	YARD	31	
COSTELLO	9"	54"	117.00	YARD	13	E03032		55"	316.00	YARD	36	
COTTINGHAM	27"	1/2"	89.00	YARD	20	E07046		1/2"	276.00	YARD		
COTY/D	13	1/2"	54"	39.80	YARD	5	E07406		1/2"	276.00	YARD	
COURBET	6"	1/2"	89.00	YARD	12	E08004		55"	177.00	YARD	21	
COWHIDE	30"	54"	179.00	YARD	36	E08012		55"	199.00	YARD	31	
CR-SMSUEDE		54"	59.90	YARD	12	E08306		1/2"	256.00	YARD		
CR-SUEDE		54"	59.80	YARD	12	E08310	14"	122"	450.00	YARD		
CRAFTWORK	13"	54"	199.00	YARD	30	E08312		116"	199.00	YARD		
CROCAGATOR		51"	89.80	YARD	14	E08318		110"	296.00	YARD		
CROSSCUT		54"	199.00	YARD	30	E08700		55"	236.00	YARD	31	
CRUX		54"	79.80	YARD	10	E09106	35"	55"	296.00	YARD	56	
CUENCA		54"	59.90	YARD	9	E09108		55"	240.00	YARD	33	

Prices herein quoted are suggested retail. Prices are subject to change without notice. All shipping and special processing charges are additional.

US Retail Price List - August 2016

Pattern	Repeat	Width	Price	UOM	Grade	Pattern	Repeat	Width	Price	UOM	Grade
E09112	15"	53"	498.00	YARD		GAHNITE	27"	54"	51.90	YARD	20
E09114		51"	297.00	YARD		GAINCOPE	27"	54"	65.90	YARD	25
E09200		53"	199.00	YARD	24	GALATA	27"	54"	68.90	YARD	17
E09300		118"	230.00	YARD		GALENA	27"	1/2"	99.80	YARD	21
E09302	12"	134"	230.00	YARD		GALLEON		54"	159.00	YARD	23
E09304		122"	230.00	YARD		GALUCHAT		55"	296.00	YARD	39
E09312		57"	220.00	YARD		GALVESTON		54"	59.90	YARD	9
E09318	27 1/2"	124"	330.00	YARD		GARBO	18"	55"	398.00	YARD	
E4018			199.00	YARD		GARCONNE	70"	55"	276.00	YARD	
EARL		54"	47.00	YARD	9	GAROUA		54"	189.00	YARD	24
EBANO		117"	270.00	YARD		GARTH	25"	54"	59.80	YARD	9
EDGY SHARK		54"	139.00	YARD	21	GARUDA	26"	54"	55.90	YARD	17
EL PORTAL	23 3/4"	54"	57.90	YARD	22	GARVEY/D	25"	54"	59.80	YARD	5
ELAZA	25"	56"	177.00	YARD	30	GATO		54"	149.00	YARD	22
ELEANORA	7"	54"	41.90	YARD	8	GATOR GLAM	2"	55"	250.00	YARD	22
ELECTRIFY	9"	1/2"	79.00	YARD	11	GATSBY	7"	54"	79.00	YARD	10
ELM		122"	296.00	YARD		GAUTHIER	9 1/2"	55"	299.00	YARD	46
ENNISMORE	27"	1/2"	79.80	YARD	18	GAZEBO/D	6 1/2"	54"	33.90	YARD	5
ENVISIONED	27"	56"	177.00	YARD	37	GEBAUDR	3"	54"	67.00	YARD	14
EPITOME	4 1/2"	54"	139.00	YARD	21	GENNARINO	13 1/2"	54"	59.90	YARD	16
ERIE		59"	45.00	YARD	13	GENSLAR		54"	153.00	YARD	23
ERRINGTON	27"	1/2"	95.00	YARD	22	GEO CLUB	36"	1/2"	119.00	YARD	25
ESOTERIC	25"	55"	299.00	YARD	42	GERAINE	18"	54"	79.80	YARD	11
ESPOSITO	13 1/2"	54"	15.90	YARD		GERANIUM/D	26 1/2"	54"	49.00	YARD	5
ESSEX	18"	55"	119.00	YARD	24	GERARD	27"	1/2"	99.80	YARD	16
ESTELLE/D	27"	60"	45.00	YARD	5	GERBERA	27"	54"	99.00	YARD	23
ETCHING		54"	149.00	YARD	22	GERE	9"	1/2"	97.00	YARD	12
ETE PLAID	1"	56"	89.80	YARD	7	GESTURE	31 1/2"	52"	177.00	YARD	37
EVENING SILK		54"	99.80	YARD	24	GHOST TOWN		54"	59.90	YARD	9
EVERSON	5 1/2"	55"	129.00	YARD	22	GIEDI	1"	54"	43.90	YARD	5
FAB FAUX	7"	54"	145.00	YARD	21	GIFU	4 1/2"	54"	59.90	YARD	12
FABIOLA		54"	79.80	YARD	5	GIGGLE/D	18"	1/2"	39.00	YARD	5
FABO	27"	54"	59.80	YARD	9	GILDED		54"	145.00	YARD	22
FADEDJEANS	32"	55"	270.00	YARD	64	GILLIAN		54"	159.00	YARD	23
FAITH/D	18"	54"	49.80	YARD	5	GITTENS	36"	54"	79.80	YARD	10
FAME		55"	198.00	YARD	14	GLAZE		54"	125.00	YARD	
FANTASY VELVE		53"	99.80	YARD		GLENBURN	25"	54"	53.90	YARD	14
FARNELL/D	25"	54"	29.90	YARD	5	GLENDALE		54"	159.00	YARD	23
FAUNA	9"	54"	99.00	YARD	14	GLENSHAW	5 1/2"	1/2"	99.80	YARD	19
FAUX HIDE		54"	137.00	YARD	20	GLITZ		54"	85.00	YARD	11
FAUX METAL		54"	135.00	YARD	20	GLOBAL	25"	54"	48.90	YARD	13
FAUX SATIN		54"	145.00	YARD	22	GLOSS OVER		54"	145.00	YARD	22
FAUX WEAVE		54"	199.00	YARD	30	GOBELIN	27"	55"	236.00	YARD	38
FAVORITE	31"	1/2"	199.00	YARD	56	GOBI		55"	230.00	YARD	26
FAWN		54"	79.80	YARD	10	GOLDING/D	27"	54"	57.00	YARD	5
FERNMORE/D	27"	54"	49.80	YARD	5	GOLDMINE	5"	1/2"	99.00	YARD	13
FIERCE	15"	54"	177.00	YARD	32	GOODELL/D		61"	39.80	YARD	5
FIorenZA	18"	54"	55.00	YARD	13	GR-32000-0000		54"	99.80	YARD	21
FLANNEL-S		55"	157.00	YARD	25	GR-40012-0008		54"	69.80	YARD	12
FLORID	16"	57"	55.00	YARD	13	GR-40012-0009		54"	69.80	YARD	12
FLOYD/D	34 1/2"	137"	37.00	YARD	5	GR-40012-0010		54"	69.80	YARD	12
FOREST/D	25 1/2"	54"	127.00	YARD	5	GR-40012-0024		54"	69.80	YARD	12
FORGETFUL		54"	199.00	YARD	30	GR-40014-0000		54"	69.00	YARD	12
FORMAN		54"	59.00	YARD	11	GR-40014-0005		54"	69.00	YARD	12
FORTUNE		54"	119.80	YARD	20	GR-40014-0008		54"	69.00	YARD	12
FRAME IN	27"	55"	99.80	YARD	25	GR-40014-0013		54"	69.00	YARD	12
FROSTED WO	27"	54"	177.00	YARD		GR-40014-0021		54"	69.00	YARD	12
FUNKYZEBRA	36"	1/2"	129.00	YARD	27	GR-40014-0035		54"	69.00	YARD	12
FUTURO		54"	85.00	YARD	11	GR-40014-0047		54"	69.00	YARD	12
GABALA		54"	189.00	YARD	24	GR-40038-0007	9"	54"	75.00	YARD	13
GABLE/D	13 1/2"	54"	59.80	YARD	5	GR-40088-0007	5"	54"	75.00	YARD	15
GABRIELLA	25"	54"	79.80	YARD		GR-40161-0000	7"	54"	89.00	YARD	12
GAGAKU		54"	65.90	YARD	25	GR-40161-0001	7"	54"	89.00	YARD	12

Prices herein quoted are suggested retail. Prices are subject to change without notice. All shipping and special processing charges are additional.

US Retail Price List - August 2016

Pattern	Repeat	Width	Price	UOM	Grade	Pattern	Repeat	Width	Price	UOM	Grade
GR-40161-0002	7"	54"	89.00	YARD	12	GR-8011-0000		54"	75.00	YARD	13
GR-40161-0003	7"	54"	89.00	YARD	12	GR-8013-0000		54"	75.00	YARD	13
GR-42001-0004		54"	97.00	YARD	17	GR-8017-0000		54"	75.00	YARD	13
GR-42006-0000		54"	85.00	YARD	16	GR-8052-0000		54"	75.00	YARD	13
GR-42010-0002		54"	85.00	YARD	16	GR-8319-0000		54"	69.00	YARD	12
GR-42011-0000		54"	149.00	YARD	26	GR-8322-0000		54"	69.00	YARD	12
GR-42011-0001		54"	149.00	YARD	26	GR-8351-0000		54"	75.00	YARD	14
GR-42013-0003		54"	119.00	YARD	24	GRADY/D	13 1/2"	54"	59.80	YARD	5
GR-42013-0004		54"	119.00	YARD	24	GRAIN	13 1/2"	54"	41.00	YARD	10
GR-42013-0005		54"	119.00	YARD	24	GRANA		54"	177.90	YARD	26
GR-42015-0000		54"	149.00	YARD	27	GRASSET	6"	54"	63.90	YARD	14
GR-42017-0003		54"	99.80	YARD	19	GRATA	1"	54"	59.90	YARD	10
GR-44022-0010		54"	73.00	YARD	15	GRAVURES	13 1/2"	58"	41.00	YARD	11
GR-44118-0009		54"	99.00	YARD	14	GREMIAL		54"	51.90	YARD	13
GR-46003-0000	1 1/2"	54"	159.00	YARD	40	GRID	20 1/2"	57"	296.00	YARD	40
GR-46003-0001	1 1/2"	54"	159.00	YARD	40	GRIFFITH	13 1/2"	55"	99.00	YARD	19
GR-46003-0004	1 1/2"	54"	159.00	YARD	40	GROOVE		54"	43.00	YARD	8
GR-46003-0007	1 1/2"	54"	159.00	YARD	40	GROOVE ON		54"	159.00	YARD	25
GR-46003-0010	1 1/2"	54"	159.00	YARD	40	GROOVY	8"	54"	199.00	YARD	29
GR-46003-0011	1 1/2"	54"	159.00	YARD	40	GUAVA	25 1/2"	54"	67.00	YARD	23
GR-46003-0013	1 1/2"	54"	159.00	YARD	40	GUESS/D		54"	24.90	YARD	5
GR-51000-0000		54"	49.80	YARD		GUINAN		54"	59.90	YARD	7
GR-51000-0001		54"	49.80	YARD		GUJARANT	25 1/4"	54"	59.90	YARD	22
GR-52001-0000		54"	59.80	YARD		GUPPIE/D	27"	54"	27.90	YARD	5
GR-52001-0001		54"	59.80	YARD		GWEN/D	27"	54"	59.80	YARD	5
GR-54011-0000		54"	61.90	YARD	11	HABEAS	13 1/2"	54"	46.90	YARD	16
GR-5403-0000		54"	61.90	YARD	11	HADJEE	4 1/2"	54"	31.90	YARD	13
GR-5404-0000		54"	61.90	YARD	11	HAIKU		55"	196.00	YARD	19
GR-5406-0000		54"	61.90	YARD	9	HANKER	25 1/2"	54"	51.90	YARD	14
GR-5408-0000		54"	61.90	YARD	11	HARCOURT		54"	47.00	YARD	
GR-5410-0000		54"	55.90	YARD	9	HARISHENA	13"	54"	76.90	YARD	15
GR-5415-0000		54"	61.90	YARD	9	HARMONY		54"	59.00	YARD	11
GR-5416-0000		54"	61.90	YARD	11	HARPIST	16"	55"	47.00	YARD	14
GR-5417-0000		54"	61.90	YARD	11	HARPSICORD	25"	54"	59.90	YARD	20
GR-5420-0000		54"	61.90	YARD	11	HAUTE CROC	9"	54"	145.00	YARD	21
GR-5422-0000		54"	61.90	YARD	11	HAUTE FAUX		54"	145.00	YARD	22
GR-5424-0000		54"	61.90	YARD	11	HAUTE-ESTE		52"	125.00	YARD	
GR-5425-0000		54"	61.90	YARD	11	HAVOCK	4 1/2"	54"	41.90	YARD	9
GR-5426-0000		54"	61.90	YARD	11	HAYRIDE	12 1/2"	58"	41.90	YARD	11
GR-5432-0000		54"	61.90	YARD	11	HAZELNUTS	3 1/2"	54"	35.00	YARD	8
GR-5438-0000		54"	61.90	YARD	11	HAZELTON		54"	15.90	YARD	
GR-5439-0000		54"	61.90	YARD	11	HAZELWOOD	13 1/2"	1/2"	85.00	YARD	18
GR-5446-0000		54"	61.90	YARD	11	HECTIC/D	18"	54"	49.80	YARD	5
GR-5452-0000		54"	61.90	YARD	11	HEFTIEST	36"	54"	51.90	YARD	15
GR-5453-0000		54"	61.90	YARD	11	HERBARIUM	43 1/2"	1/2"	296.00	YARD	
GR-5457-0000		54"	61.90	YARD	11	HEXADS/D	18"	54"	79.80	YARD	5
GR-5461-0000		54"	61.90	YARD	11	HIBISCUS	36"	54"	59.90	YARD	24
GR-5468-0000		54"	61.90	YARD	11	HIGHEST	12 1/2"	54"	51.90	YARD	14
GR-5472-0000		54"	61.90	YARD	11	HIGHPOINT	6 1/2"	1/2"	69.80	YARD	14
GR-5476-0000		54"	61.90	YARD	11	HILBERT	10"	54"	76.90	YARD	21
GR-5477-0000		54"	61.90	YARD	11	HINTER/D	27"	54"	79.80	YARD	5
GR-5499-0000		54"	61.90	YARD	11	HOLDOUT	24"	56"	55.00	YARD	14
GR-5601-0000		54"	75.00	YARD	12	HOMONY	25"	54"	47.00	YARD	18
GR-5602-0000		54"	75.00	YARD	12	HOSTLY	25"	54"	55.00	YARD	19
GR-5695-0000		54"	59.80	YARD	12	HOWDIE/D		54"	49.80	YARD	5
GR-70000-0000		54"	99.00	YARD	19	HUAPI	6 1/2"	54"	52.90	YARD	13
GR-70000-0002		54"	99.00	YARD	19	HUBBLE		54"	59.90	YARD	7
GR-70000-0003		54"	99.00	YARD	19	HUGGING	18"	54"	47.00	YARD	17
GR-70000-0005		54"	99.00	YARD	19	HUMANITY	25"	53"	99.00	YARD	
GR-70000-0007		54"	99.00	YARD	19	HUMIDOR	8"	54"	33.00	YARD	9
GR-7704-0000		54"	69.00	YARD	13	HYBRID	36"	58"	97.00	YARD	22
GR-7761-0000		54"	65.00	YARD	15	ICARO	7 1/2"	118"	290.00	YARD	
GR-8010-0000		54"	75.00	YARD	13	IDELLE	36"	54"	75.00	YARD	23

Prices herein quoted are suggested retail. Prices are subject to change without notice. All shipping and special processing charges are additional.

US Retail Price List - August 2016

Pattern	Repeat	Width	Price	UOM	Grade	Pattern	Repeat	Width	Price	UOM	Grade		
IDEOLOGY	36"	54"	59.90	YARD	24	KALINA	32"	54"	55.90	YARD			
IDYLLWILD	64"	54"	199.00	YARD		KAMALA	18"	1/2"	119.00	YARD	22		
ILLETES		120"	230.00	YARD		KAMLET		54"	51.50	YARD	14		
IMPACT		54"	133.00	YARD	20	KANKER	32"	54"	63.90	YARD	23		
IMPALA	30"	55"	179.00	YARD	34	KAPURTHALA	17	1/2"	1/2"	490.00	YARD		
IN A WHILE	19	1/2"	54"	85.00	YARD	14	KARACHI	6	1/2"	54"	47.00	YARD	16
IN BALANCE	4"	54"	197.00	YARD	30	KAREN	13	1/2"	54"	55.90	YARD	20	
IN BLOOM	27"	55"	199.00	YARD	41	KARIBA		54"	79.00	YARD	10		
IN GROOVE	8"	54"	197.00	YARD	30	KARMINE		54"	135.00	YARD			
INDAGE	27"	53"	199.00	YARD	40	KASARA	15	1/2"	51"	129.00	YARD	27	
INDICAN	12	1/2"	54"	169.00	YARD	26	KASHMIRA	3	1/2"	1/2"	59.80	YARD	13
INDO DAY	27"	54"	149.00	YARD	24	KASS	27"	54"	53.80	YARD	20		
INDO NIGHT	36"	54"	137.00	YARD	24	KASTON		54"	65.00	YARD	8		
INNESSA	25"	54"	75.00	YARD	30	KAUNOLU	27"	54"	69.00	YARD	12		
INGRID	27"	54"	55.90	YARD	20	KAVEKA	2	1/2"	55"	197.00	YARD	29	
INNIS	25"	54"	53.00	YARD	18	KAWEAH	9"	54"	55.90	YARD	19		
INSCRIBED	2"	54"	139.00	YARD	21	KAY	12"	54"	65.00	YARD	18		
INSIGNIA	5	1/2"	1/2"	79.00	YARD	16	KAYAK	4	1/2"	54"	55.90	YARD	17
INVENTION		54"	159.00	YARD	24	KAZOO	25"	54"	51.50	YARD	16		
INVOLVE	13	1/2"	54"	55.90	YARD	14	KEA	27"	54"	119.00	YARD	24	
IRENE	27"	54"	37.50	YARD	14	KEISHA	25"	54"	53.80	YARD	19		
IRISA	25"	54"	69.00	YARD		KELIM	25"	54"	68.90	YARD	16		
IRVING	8"	54"	69.90	YARD	20	KELLOGG	12"	54"	55.90	YARD	13		
ISHANA	27"	1/2"	97.00	YARD	20	KELVIN		54"	79.80	YARD	11		
ISTA	25"	54"	39.80	YARD	13	KEMER	16"	51"	111.00	YARD	31		
ISTRIA	27"	1/2"	99.80	YARD	20	KEMI	12	1/2"	54"	43.00	YARD	9	
ITHICA	9"	1/2"	99.80	YARD	12	KENAI	25"	54"	197.00	YARD	33		
IVANA	36"	54"	59.90	YARD	20	KENZAN		55"	248.00	YARD	34		
IVONNE	18"	54"	45.00	YARD	17	KEOGH	13	1/2"	54"	55.90	YARD	14	
IZNIKOASIS	27"	1/2"	129.00	YARD	28	KERMES	27"	54"	97.00	YARD	18		
IZU	21	1/2"	54"	396.00	YARD		KERRY	27"	54"	43.80	YARD	14	
JA NOVA RR	5	1/2"	118"	99.00	YARD		KETENE	13	1/2"	54"	55.90	YARD	16
JACANA	27"	54"	41.90	YARD	12	KEVIN	1	1/2"	54"	33.90	YARD	9	
JACOBY	25"	54"	59.90	YARD	23	KHAN		55"	196.00	YARD	19		
JAIN		54"	41.90	YARD	8	KHASH	36"	54"	62.90	YARD	20		
JAMAICA		124"	176.00	YARD	18	KID GLOVE		54"	169.00	YARD	26		
JARAPA		54"	348.00	YARD	34	KIDDO	18"	1/2"	53.90	YARD	19		
JARRON	35"	58"	199.00	YARD		KIFARU		54"	59.90	YARD	6		
JAVA IKAT	25"	55"	129.00	YARD	25	KILIAN	26"	54"	49.90	YARD	20		
JAX	18"	54"	55.90	YARD	14	KILLEEN		54"	59.90	YARD	9		
JAYVEE	18"	54"	55.90	YARD	21	KILTERY	7"	54"	35.00	YARD	8		
JAZZ	13	1/2"	52"	298.00	YARD		KIMMEL	13	1/2"	1/2"	89.80	YARD	10
JAZZIE RR	4	1/2"	118"	99.00	YARD		KINGSLEY	36"	54"	129.00	YARD	21	
JELLYBEAN	27"	54"	74.90	YARD	27	KIYOMI	27"	54"	55.90	YARD			
JEMBER	18"	54"	51.90	YARD	15	KORDOFAN	13	1/2"	54"	43.80	YARD	11	
JEREMY	27"	54"	55.90	YARD	21	KOSOVO	25"	54"	71.90	YARD	26		
JETHRO	14	1/2"	54"	197.00	YARD	38	KOTA	18"	1/2"	51.90	YARD	19	
JIEPANG	7"	54"	76.90	YARD	14	KOU	18"	54"	55.00	YARD	17		
JINGLE	2"	54"	55.90	YARD	11	KUDZU	27"	54"	59.90	YARD	22		
JIONI		54"	59.90	YARD	8	KUMI		54"	59.90	YARD	6		
JODDY	25"	54"	59.90	YARD	23	KUPANG	25"	54"	55.80	YARD	30		
JONAH	27"	54"	55.90	YARD	16	KURA KURA	36"	54"	79.80	YARD	13		
JOSHUA	3"	54"	55.90	YARD	18	KURTA	53"	55"	248.00	YARD			
JOYFUL	13	1/2"	54"	55.90	YARD	14	KUSH	27"	54"	47.80	YARD	18	
JUFTI	25"	54"	75.90	YARD	20	KYLIN		54"	59.00	YARD	11		
JUNCO		116"	296.00	YARD		KYOTO	23	1/2"	54"	316.00	YARD		
JUNE	27"	54"	75.00	YARD	26	KYRIE	25"	54"	71.90	YARD	26		
JUST SO	25"	54"	59.90	YARD	23	L-AKRON			39.00	SQFT			
KACHINA	12	1/2"	54"	55.90	YARD	18	L-AKRONA			39.00	SQFT		
KADIRI	32"	54"	57.90	YARD	16	L-ALLIGATO			27.90	SQFT			
KADRU	25	1/4"	54"	47.90	YARD	13	L-AMERICA			27.90	SQFT		
KAFTAN	27	1/2"	55"	256.00	YARD		L-ANIMAL			27.90	SQFT		
KALIMANTAN		54"	43.80	YARD	11	L-ARIZONA			29.90	SQFT			

Prices herein quoted are suggested retail. Prices are subject to change without notice. All shipping and special processing charges are additional.

US Retail Price List - August 2016

Pattern	Repeat	Width	Price	UOM	Grade	Pattern	Repeat	Width	Price	UOM	Grade
L-ATHENS			39.90	SQFT		L-PADRE			23.90	SQFT	
L-BADEN			31.90	SQFT		L-PAMPERED			79.80	SQFT	
L-BALI			59.00	SQFT		L-PARIS	7"		39.00	SQFT	
L-BEAUMONT			29.00	SQFT		L-PARLIAME			29.90	SQFT	
L-BERLIN			39.00	SQFT		L-POLO			31.90	SQFT	
L-BERN			29.90	SQFT		L-PORTOFIN			29.90	SQFT	
L-BEXAR			29.90	SQFT		L-RANCHO			21.90	SQFT	
L-BROCKWAY			23.90	SQFT		L-RANGE			35.00	SQFT	
L-CALF			33.90	SQFT		L-RODEO			25.90	SQFT	
L-CALVIN			35.90	SQFT		L-ROYALINE			39.90	SQFT	
L-CAMPFIRE			17.90	SQFT		L-RUGGED			35.00	SQFT	
L-CANTLE			29.90	SQFT		L-RUSHMORE			27.90	SQFT	
L-CATTLE			19.90	SQFT		L-SACHEM			23.90	SQFT	
L-CAVESSON			31.90	SQFT		L-SAGUARO			29.90	SQFT	
L-CHAPETTE			29.00	YARD		L-SAPI			29.90	SQFT	
L-CHARRO			27.90	SQFT		L-SERENE			25.90	SQFT	
L-COACHMAN			29.90	SQFT		L-SIGNATUR			27.90	SQFT	
L-COBBLER			19.90	SQFT		L-SINAR			49.90	SQFT	
L-COSMO			31.90	SQFT		L-SLEEK			39.00	SQFT	
L-COUNTRY			35.00	SQFT		L-SOMBRERO			27.90	SQFT	
L-COVETED			49.90	SQFT		L-SPECTRUM			29.90	YARD	
L-COWGIRL			17.90	SQFT		L-STABLE			23.90	SQFT	
L-CUERO			29.00	SQFT		L-SUPERIOR			29.00	SQFT	
L-DAVOS			29.00	SQFT		L-TEXAS			29.90	SQFT	
L-DELUXE			15.90	SQFT		L-TIMELESS			35.00	SQFT	
L-DENIM			23.90	SQFT		L-TIPPED			47.00	SQFT	
L-DISTRESS			29.00	SQFT		L-TORONTO			39.90	SQFT	
L-DUNMOORE			29.00	SQFT		L-TRAIL			25.90	SQFT	
L-EDGY			39.00	SQFT		L-TUSCANY			39.90	SQFT	
L-ENDULGED			49.90	SQFT		L-UPSHUR			29.90	SQFT	
L-ENTITLED			79.90	SQFT		L-UTAH			29.90	SQFT	
L-EQUINE			37.00	SQFT		L-VAQUERO			19.00	SQFT	
L-FARGO			23.90	SQFT		L-VAVOOM			39.90	SQFT	
L-FIRENZE			29.90	YARD		L-WET CROC			39.90	SQFT	
L-FOIL			33.90	SQFT		L-YAMA			27.90	SQFT	
L-GATOR			45.00	SQFT		LA MESA		54"	59.90	YARD	9
L-GENUINE			23.90	SQFT		LA1000		55"	45.90	YARD	14
L-GUAPO			23.90	SQFT		LA1002		48"	17.00	YARD	7
L-HASBROOK			27.90	SQFT		LA1036	27"	54"	65.00	YARD	15
L-HAUTE			31.90	SQFT		LA1043	13 1/2"	54"	69.00	YARD	14
L-HERO			29.90	SQFT		LA1093		54"	41.90	YARD	8
L-HIP			29.90	SQFT		LA1170		54"	119.80	YARD	21
L-HOLSTON			23.90	SQFT		LA1193		50"	149.00	YARD	21
L-HYPE			25.90	SQFT		LA1242	2 1/2"	54"	99.80	YARD	14
L-INN			17.90	SQFT		LA1285	25"	54"	89.00	YARD	19
L-IRONSIDE			17.90	SQFT		LA1293		54"	69.90	YARD	7
L-JAVA			35.90	SQFT		LA1317	25"	54"	59.80	YARD	9
L-KESTREL			25.90	SQFT		LA1324	35"	54"	69.80	YARD	16
L-KINGS CA			29.90	SQFT		LA1336	13 1/2"	54"	65.00	YARD	11
L-LONEROCK			19.90	SQFT		LA1338	18"	54"	79.80	YARD	11
L-LUCERNE			39.90	SQFT		LACET	3 1/2"	54"	85.00	YARD	14
L-LUSTROUS			33.00	SQFT		LAKAI	27"	54"	49.90	YARD	13
L-MADRID			39.90	SQFT		LALIN		54"	67.00	YARD	8
L-MAVERICK			19.90	SQFT		LAMORAL	13 1/2"	54"	51.50	YARD	13
L-MODERN			31.90	SQFT		LANETTA	13 1/2"	54"	49.00	YARD	5
L-MONUMENT			27.90	SQFT		LASIANDRA	25 1/2"	54"	67.00	YARD	25
L-NEBO			39.90	SQFT		LATIKA	18"	54"	87.00	YARD	18
L-NEVONA			23.90	SQFT		LATURA	25 1/2"	54"	59.90	YARD	17
L-NIMBLE			49.80	SQFT		LAUER		57"	53.90	YARD	11
L-NOGALES			29.90	SQFT		LAVANDA	25" 1/2"		450.00	YARD	
L-NOVELTY	20"		53.00	SQFT		LAVASSE	9"	54"	79.80	YARD	10
L-OLD WEST			19.00	SQFT		LCF13400F	27"	54"	108.00	YARD	27
L-OXER			29.00	SQFT		LCF13536F	2 3/4"	54"	108.00	YARD	23

Prices herein quoted are suggested retail. Prices are subject to change without notice. All shipping and special processing charges are additional.

US Retail Price List - August 2016

Pattern	Repeat	Width	Price	UOM	Grade	Pattern	Repeat	Width	Price	UOM	Grade		
LCF13564F	6	1/4"	54"	108.00	YARD	23	LCF24526F	36"	54"	100.00	YARD	25	
LCF13565F	6	1/4"	54"	108.00	YARD	23	LCF24535F	27"	54"	96.00	YARD	29	
LCF13568F	6	1/4"	54"	108.00	YARD	26	LCF24585F	18"	54"	116.00	YARD		
LCF13585F			54"	116.00	YARD	21	LCF24586F	18"	54"	116.00	YARD	26	
LCF14104F	13	1/2"	54"	94.00	YARD	23	LCF24588F	18"	54"	116.00	YARD	26	
LCF14440F		30"	54"	112.00	YARD		LCF25560F	13	1/2"	54"	116.00	YARD	28
LCF14442F		30"	54"	112.00	YARD	28	LCF28261F		27"	54"	104.00	YARD	24
LCF14559F			56"	60.00	YARD		LCF28420F		9"	54"	92.00	YARD	18
LCF14646F		1/4"	55"	124.00	YARD	22	LCF28460F		27"	54"	116.00	YARD	
LCF14647F		9"	60"	88.00	YARD		LCF28472F	25	1/4"	54"	84.00	YARD	26
LCF14648F		9"	60"	88.00	YARD		LCF28501F		9"	54"	136.00	YARD	34
LCF14649F		1/4"	55"	124.00	YARD	23	LCF28503F		9"	54"	136.00	YARD	
LCF14788F	13	1/4"	54"	100.00	YARD	30	LCF28778F		14"	54"	92.00	YARD	26
LCF14883F	13	1/2"	55"	104.00	YARD	23	LCF29690F	4	1/2"	56"	100.00	YARD	19
LCF14963F	13	1/2"	54"	92.00	YARD	28	LCF29693F	4	1/2"	56"	100.00	YARD	21
LCF16509F		18"	54"	164.00	YARD	36	LCF29694F	4	1/2"	56"	100.00	YARD	21
LCF17096F			55"	116.00	YARD	26	LCF29698F	5	3/4"	54"	108.00	YARD	21
LCF17100F	6	3/4"	54"	116.00	YARD	25	LCF29704F	13	1/2"	55"	194.00	YARD	46
LCF17916F		27"	54"	84.00	YARD	26	LCF29709F	13	1/2"	56"	146.00	YARD	29
LCF18204F			54"	124.00	YARD	22	LCF29720F	6	3/4"	55"	168.00	YARD	36
LCF18222F			54"	128.00	YARD	25	LCF29731F			59"	108.00	YARD	21
LCF18223F			54"	128.00	YARD	25	LCF30031F	6	3/4"	54"	136.00	YARD	26
LCF18249F		27"	54"	92.00	YARD	23	LCF30141F		18"	54"	128.00	YARD	
LCF18251F		27"	54"	92.00	YARD	23	LCF30142F		18"	54"	128.00	YARD	28
LCF18356F		27"	69"	156.00	YARD	36	LCF30260F		3/4"	55"	124.00	YARD	24
LCF18375F		27"	54"	116.00	YARD	29	LCF40034F		6"	54"	108.00	YARD	26
LCF18376F		27"	54"	116.00	YARD	34	LCF40070F		30"	54"	112.00	YARD	29
LCF18834F	13	1/2"	54"	84.00	YARD		LCF40071F		30"	54"	112.00	YARD	
LCF18840F		27"	54"	96.00	YARD	29	LCF40135F	2	3/4"	53"	172.00	YARD	40
LCF18880F		18"	54"	92.00	YARD	20	LCF40450F	18	1/4"	55"	100.00	YARD	22
LCF19025F		1/4"	55"	124.00	YARD	26	LCF40653F		1/2"	56"	108.00	YARD	28
LCF19044F			54"	124.00	YARD	25	LCF40657F			54"	112.00	YARD	22
LCF19731F		27"	54"	128.00	YARD	37	LCF40687F		1/2"	56"	104.00	YARD	20
LCF19732F		27"	54"	128.00	YARD	32	LCF40688F		1/2"	56"	108.00	YARD	28
LCF19797F		18"	63"	172.00	YARD	38	LCF40689F		2"	56"	124.00	YARD	24
LCF20204F	13	1/2"	54"	160.00	YARD	36	LCF40690F		2"	56"	124.00	YARD	
LCF20217F			53"	164.00	YARD	34	LCF40693F		2"	56"	124.00	YARD	26
LCF20218F			54"	164.00	YARD	34	LCF40694F		2"	56"	124.00	YARD	
LCF20237F		14"	55"	224.00	YARD		LCF40697F		2"	56"	124.00	YARD	24
LCF20239F		14"	55"	224.00	YARD	54	LCF40774F			39"	144.00	YARD	
LCF20832F			54"	112.00	YARD	22	LCF40775F			54"	88.00	YARD	
LCF20853F			54"	112.00	YARD	22	LCF40776F			54"	92.00	YARD	
LCF20854F			54"	116.00	YARD	22	LCF40777F			54"	96.00	YARD	
LCF20889F		27"	54"	104.00	YARD	24	LCF40790F			54"	76.00	YARD	
LCF20918F		27"	54"	116.00	YARD	32	LCF40801F	44	1/2"	60"	96.00	YARD	
LCF20992F	13	1/2"	55"	136.00	YARD		LCF50206F	25	1/4"	54"	112.00	YARD	33
LCF22069F	12	1/2"	54"	116.00	YARD	25	LCF50241F	1	7/8"	55"	104.00	YARD	
LCF22092F		15"	54"	108.00	YARD	30	LCF50250F			54"	116.00	YARD	
LCF22095F	12	1/2"	54"	116.00	YARD	26	LCF50278F	3	1/4"	56"	108.00	YARD	21
LCF23112F	13	1/2"	54"	112.00	YARD	27	LCF50279F	3	1/4"	56"	108.00	YARD	23
LCF23169F			44"	164.00	YARD		LCF50555F		36"	54"	128.00	YARD	32
LCF24304F			55"	116.00	YARD	28	LCF50609F		12"	56"	150.00	YARD	32
LCF24311F		18"	54"	104.00	YARD	23	LCF50640F		4"	56"	144.00	YARD	28
LCF24340F	25	1/4"	51"	116.00	YARD		LCF50644F	3	1/8"	56"	150.00	YARD	31
LCF24341F	25	1/4"	51"	116.00	YARD	35	LCF50780F			59"	84.00	YARD	17
LCF24360F			54"	112.00	YARD	20	LCF50786F			55"	88.00	YARD	15
LCF24362F			54"	112.00	YARD	22	LCF50787F			55"	84.00	YARD	
LCF24380F		10"	57"	204.00	YARD	44	LCF50788F			55"	88.00	YARD	17
LCF24381F		10"	57"	204.00	YARD	46	LCF50792F	27	1/2"	55"	100.00	YARD	
LCF24382F		10"	57"	204.00	YARD	40	LCF50795F	27	1/2"	55"	100.00	YARD	25
LCF24383F		10"	57"	204.00	YARD	40	LCF50802F				84.00	YARD	
LCF24473F		18"	51"	108.00	YARD	27	LCF50807F			54"	128.00	YARD	
LCF24490F	25	1/4"	54"	164.00	YARD	41	LCF50809F			54"	128.00	YARD	27

Prices herein quoted are suggested retail. Prices are subject to change without notice. All shipping and special processing charges are additional.

US Retail Price List - August 2016

Pattern	Repeat	Width	Price	UOM	Grade	Pattern	Repeat	Width	Price	UOM	Grade
LCF50810F		54"	128.00	YARD	25	LCF64781F		56"	164.00	YARD	25
LCF60196F		60"	104.00	YARD	18	LCF64782F		56"	164.00	YARD	25
LCF60197F		60"	104.00	YARD	18	LCF64783F		56"	164.00	YARD	25
LCF60198F		60"	104.00	YARD	18	LCF64784F		54"	124.00	YARD	20
LCF60365F	9"	54"	96.00	YARD	19	LCF64785F		54"	124.00	YARD	20
LCF60380F	1/4"	55"	88.00	YARD	16	LCF64786F		54"	228.00	YARD	38
LCF60382F	1/4"	55"	80.00	YARD	14	LCF64787F		54"	228.00	YARD	38
LCF60421F	13 1/2"	54"	92.00	YARD	20	LCF64788F		54"	228.00	YARD	38
LCF60422F	13 1/2"	54"	92.00	YARD		LCF64789F	7 3/4"	54"	236.00	YARD	40
LCF62303F	6 1/4"	54"	380.00	YARD		LCF64790F	7 3/4"	54"	236.00	YARD	40
LCF62304F		58"	160.00	YARD	30	LCF64791F	7 3/4"	54"	236.00	YARD	40
LCF62305F	6 5/8"	53"	332.00	YARD	65	LCF64792F	7 3/4"	54"	236.00	YARD	40
LCF62316F		58"	176.00	YARD		LCF64799F	7 1/4"	54"	208.00	YARD	36
LCF62351F	13 1/2"	54"	292.00	YARD		LCF64802F	7 1/8"	47"	236.00	YARD	64
LCF62352F	13 1/2"	54"	292.00	YARD		LCF64803F	7 1/8"	47"	236.00	YARD	
LCF62359F			168.00	YARD		LCF64805F	6 3/4"	54"	200.00	YARD	39
LCF62360F	27"	54"	112.00	YARD	26	LCF64807F	28 1/4"	54"	228.00	YARD	49
LCF62385F	18"	54"	312.00	YARD	70	LCF64808F	28 1/4"	54"	228.00	YARD	51
LCF64194F	18"	54"	52.00	YARD	11	LCF64960F	8 1/2"	56"	96.00	YARD	17
LCF64256F		58"	104.00	YARD	15	LCF65047F	27"	54"	168.00	YARD	39
LCF64262F		54"	88.00	YARD	11	LCF65049F	27"	54"	168.00	YARD	42
LCF64264F		58"	104.00	YARD	15	LCF65052F	25 1/4"	56"	276.00	YARD	62
LCF64266F		54"	90.00	YARD	11	LCF65053F	9 1/2"	53"	184.00	YARD	39
LCF64273F		54"	90.00	YARD	11	LCF65055F	15 3/4"	54"	288.00	YARD	
LCF64274F		54"	90.00	YARD	16	LCF65056F	15 3/4"	54"	276.00	YARD	59
LCF64276F		54"	90.00	YARD	16	LCF65057F		57"	232.00	YARD	45
LCF64283F		54"	88.00	YARD	11	LCF65058F	28 3/4"	53"	176.00	YARD	
LCF64284F		54"	88.00	YARD	11	LCF65059F	28 3/4"	53"	176.00	YARD	44
LCF64286F		55"	88.00	YARD		LCF65060F		55"	260.00	YARD	48
LCF64288F		54"	78.00	YARD	14	LCF65062F		58"	184.00	YARD	34
LCF64292F		55"	136.00	YARD	22	LCF65064F		54"	92.00	YARD	
LCF64294F		55"	136.00	YARD	17	LCF65065F		54"	92.00	YARD	21
LCF64440F	27"	59"	236.00	YARD	40	LCF65066F		55"	288.00	YARD	43
LCF64442F	27"	59"	236.00	YARD	40	LCF65067F		55"	288.00	YARD	47
LCF64443F	4 1/2"	59"	228.00	YARD	32	LCF65071F		57"	232.00	YARD	41
LCF64444F	4 1/2"	59"	228.00	YARD	37	LCF65075F		54"	216.00	YARD	45
LCF64451F	27"	54"	120.00	YARD		LCF65083F		54"	116.00	YARD	25
LCF64458F	14"	54"	104.00	YARD	20	LCF65085F	25 1/4"	54"	192.00	YARD	
LCF64459F	13 1/2"	54"	104.00	YARD	20	LCF65087F	27"	54"	192.00	YARD	43
LCF64461F	5 1/4"	55"	80.00	YARD	12	LCF65180F	5 1/2"	54"	180.00	YARD	34
LCF64464F	10"	55"	228.00	YARD	45	LCF65181F		54"	184.00	YARD	30
LCF64466F		54"	236.00	YARD		LCF65185F	7"	54"	164.00	YARD	
LCF64471F		57"	88.00	YARD	11	LCF65186F	7"	54"	164.00	YARD	27
LCF64472F		57"	92.00	YARD		LCF65188F		54"	120.00	YARD	
LCF64483F		50"	220.00	YARD		LCF65190F		54"	124.00	YARD	
LCF64571F	14 1/2"	55"	52.00	YARD	11	LCF65191F		54"	216.00	YARD	41
LCF64576F	15"	55"	56.00	YARD	11	LCF65192F		54"	216.00	YARD	
LCF64595F		54"	64.00	YARD	11	LCF65193F	1"	54"	224.00	YARD	43
LCF64608F	25 1/4"	54"	52.00	YARD	12	LCF65194F	1"	54"	224.00	YARD	40
LCF64760F	9"	56"	164.00	YARD	27	LCF65197F	1"	54"	224.00	YARD	41
LCF64761F	9"	56"	164.00	YARD	27	LCF65198F	3 5/8"	55"	224.00	YARD	43
LCF64762F	9"	56"	164.00	YARD	27	LCF65200F	3 5/8"	55"	224.00	YARD	43
LCF64765F		56"	164.00	YARD	24	LCF65201F	3 5/8"	55"	224.00	YARD	
LCF64766F		56"	164.00	YARD	24	LCF65202F	2 3/4"	56"	192.00	YARD	33
LCF64767F		56"	164.00	YARD	24	LCF65203F	2 3/4"	56"	192.00	YARD	45
LCF64772F		56"	164.00	YARD	26	LCF65205F		56"	192.00	YARD	30
LCF64773F		56"	164.00	YARD	24	LCF65208F		56"	192.00	YARD	34
LCF64774F		54"	124.00	YARD	18	LCF65209F	3 3/4"	56"	184.00	YARD	34
LCF64775F		54"	124.00	YARD	18	LCF65212F	3 3/4"	56"	192.00	YARD	33
LCF64777F		54"	124.00	YARD	18	LCF65215F	2 1/2"	56"	192.00	YARD	36
LCF64778F	13 1/2"	56"	208.00	YARD	39	LCF65216F	2 1/2"	56"	192.00	YARD	33
LCF64779F	13 1/2"	56"	208.00	YARD	39	LCF65217F	2 1/2"	56"	192.00	YARD	33
LCF64780F		56"	164.00	YARD	29	LCF65218F		55"	232.00	YARD	37

Prices herein quoted are suggested retail. Prices are subject to change without notice. All shipping and special processing charges are additional.

US Retail Price List - August 2016

Pattern	Repeat	Width	Price	UOM	Grade	Pattern	Repeat	Width	Price	UOM	Grade		
LCF65219F		55"	232.00	YARD	36	LCF65474F	24	1/2"	49"	132.00	YARD	33	
LCF65220F		54"	192.00	YARD	37	LCF65475F		15"	50"	132.00	YARD	32	
LCF65221F		54"	192.00	YARD		LCF65477F		5/8"	50"	132.00	YARD	26	
LCF65223F		54"	192.00	YARD		LCF65482F			56"	228.00	YARD		
LCF65231F		54"	80.00	YARD		LCF65483F			56"	268.00	YARD	44	
LCF65232F		54"	80.00	YARD		LCF65484F	22	1/4"	60"	164.00	YARD		
LCF65234F	3/4"	54"	190.00	YARD	23	LCF65486F			56"	140.00	YARD		
LCF65235F		54"	164.00	YARD		LCF65487F			35"	136.00	YARD		
LCF65236F		54"	164.00	YARD		LCF65488F			35"	136.00	YARD		
LCF65237F	12	1/2"	52"	268.00	YARD	50	LCF65489F		54"	136.00	YARD		
LCF65238F	12	1/2"	52"	268.00	YARD		LCF65490F		57"	124.00	YARD	28	
LCF65239F		3/4"	52"	216.00	YARD		LCF65491F		56"	124.00	YARD	21	
LCF65240F		3/4"	57"	216.00	YARD	41	LCF65492F		57"	220.00	YARD	36	
LCF65241F		10"	55"	236.00	YARD		LCF65493F		54"	172.00	YARD		
LCF65243F	7	7/8"	114"	304.00	YARD		LCF65494F		15"	54"	238.00	YARD	
LCF65244F	11	1/2"	114"	304.00	YARD		LCF65497F	6	3/4"	54"	124.00	YARD	
LCF65249F		54"	152.00	YARD	27	LCF65500F	13	1/2"	54"	144.00	YARD		
LCF65250F		54"	152.00	YARD		LCF65501F	13	1/2"	54"	144.00	YARD	28	
LCF65251F		54"	152.00	YARD		LCF65502F	6	3/4"	54"	124.00	YARD	29	
LCF65252F		54"	112.00	YARD		LCF65504F		18"	54"	212.00	YARD	45	
LCF65255F		7"	54"	208.00	YARD	49	LCF65505F		18"	54"	212.00	YARD	
LCF65256F		59"	204.00	YARD	53	LCF65506F		18"	54"	212.00	YARD	42	
LCF65257F		59"	204.00	YARD		LCF65507F		18"	54"	212.00	YARD	52	
LCF65258F		54"	124.00	YARD	26	LCF65508F		18"	54"	212.00	YARD		
LCF65260F		1/4"	61"	260.00	YARD		LCF65509F		12"	54"	120.00	YARD	21
LCF65262F		55"	268.00	YARD	44	LCF65510F		12"	54"	120.00	YARD		
LCF65263F		55"	268.00	YARD	44	LCF65517F	23	5"	54"	260.00	YARD		
LCF65268F		57"	164.00	YARD	26	LCF65518F			54"	144.00	YARD	27	
LCF65269F		57"	164.00	YARD		LCF65519F			54"	144.00	YARD		
LCF65270F	4	5/8"	56"	204.00	YARD	36	LCF65520F		53"	144.00	YARD	29	
LCF65271F		58"	224.00	YARD	34	LCF65522F			53"	144.00	YARD		
LCF65272F		58"	224.00	YARD	34	LCF65525F			54"	116.00	YARD		
LCF65273F	8	1/2"	54"	228.00	YARD	38	LCF65527F	15	1/2"	50"	172.00	YARD	42
LCF65281F		9"	54"	116.00	YARD	25	LCF65528F			56"	140.00	YARD	
LCF65282F		9"	54"	116.00	YARD	19	LCF65529F			54"	120.00	YARD	22
LCF65283F		54"	124.00	YARD	24	LCF65530F			54"	144.00	YARD	30	
LCF65284F	13	1/2"	54"	104.00	YARD	17	LCF65531F			53"	144.00	YARD	25
LCF65285F	13	1/2"	54"	104.00	YARD		LCF65532F			54"	144.00	YARD	27
LCF65286F		27"	54"	224.00	YARD	47	LCF65533F	7	3/8"	55"	296.00	YARD	53
LCF65287F		27"	54"	224.00	YARD	45	LCF65534F			54"	216.00	YARD	45
LCF65288F		27"	54"	224.00	YARD	47	LCF65535F			54"	216.00	YARD	37
LCF65345F		16"	54"	84.00	YARD	17	LCF65538F		7"	56"	128.00	YARD	25
LCF65352F		27"	54"	84.00	YARD	18	LCF65539F			59"	216.00	YARD	36
LCF65354F		36"	54"	108.00	YARD	31	LCF65540F			59"	216.00	YARD	
LCF65355F		36"	54"	108.00	YARD		LCF65541F			54"	136.00	YARD	
LCF65363F		10"	54"	104.00	YARD	19	LCF65542F		2"	53"	190.00	YARD	36
LCF65364F		10"	54"	104.00	YARD		LCF65543F			50"	156.00	YARD	33
LCF65365F		10"	54"	104.00	YARD		LCF65544F			56"	228.00	YARD	38
LCF65366F		10"	54"	104.00	YARD		LCF65545F		16"	54"	152.00	YARD	35
LCF65369F		54"	104.00	YARD		LCF65546F	15	1/2"	50"	172.00	YARD	39	
LCF65457F		1"	58"	256.00	YARD		LCF65547F			54"	172.00	YARD	28
LCF65458F		54"	192.00	YARD		LCF65548F			54"	172.00	YARD		
LCF65459F		16"	54"	152.00	YARD		LCF65549F		23"	54"	260.00	YARD	59
LCF65460F		120"	164.00	YARD		LCF65551F			26"	56"	196.00	YARD	44
LCF65464F		3/4"	61"	260.00	YARD		LCF65556F	25	3/4"	53"	188.00	YARD	
LCF65466F		60"	72.00	YARD		LCF65557F	25	3/4"	53"	188.00	YARD		
LCF65467F		60"	72.00	YARD	11	LCF65558F	25	3/4"	53"	188.00	YARD		
LCF65468F	16	1/4"	52"	192.00	YARD	42	LCF65559F	25	3/4"	53"	188.00	YARD	
LCF65469F		52"	176.00	YARD	33	LCF65584F			54"	144.00	YARD		
LCF65470F	15	1/2"	56"	212.00	YARD		LCF65585F			54"	144.00	YARD	25
LCF65471F		54"	144.00	YARD	25	LCF65586F			54"	120.00	YARD		
LCF65472F		54"	152.00	YARD		LCF65588F			56"	164.00	YARD	30	
LCF65473F		54"	152.00	YARD	29	LCF65589F			56"	164.00	YARD	26	

Prices herein quoted are suggested retail. Prices are subject to change without notice. All shipping and special processing charges are additional.

US Retail Price List - August 2016

Pattern	Repeat	Width	Price	UOM	Grade	Pattern	Repeat	Width	Price	UOM	Grade
LCF65590F		55"	224.00	YARD	37	LCF65812F	9 1/2"	55"	208.00	YARD	
LCF65591F		55"	196.00	YARD	30	LCF65813F	4 3/4"	55"	200.00	YARD	41
LCF65592F		55"	196.00	YARD	32	LCF65814F	4 3/4"	55"	200.00	YARD	
LCF65593F		55"	184.00	YARD	30	LCF65815F	7"	56"	168.00	YARD	34
LCF65595F		54"	124.00	YARD		LCF65816F	8"	56"	208.00	YARD	46
LCF65596F		54"	216.00	YARD	37	LCF65817F	8"	56"	208.00	YARD	
LCF65597F		54"	246.00	YARD	37	LCF65818F	8"	56"	208.00	YARD	
LCF65598F		54"	196.00	YARD	32	LCF65819F	6 1/2"	55"	204.00	YARD	40
LCF65599F		58"	168.00	YARD		LCF65821F	6 1/2"	55"	204.00	YARD	
LCF65601F		54"	224.00	YARD	41	LCF65822F	6 1/2"	55"	204.00	YARD	
LCF65602F		54"	224.00	YARD		LCF65823F	6 1/2"	55"	204.00	YARD	40
LCF65603F		54"	224.00	YARD	39	LCF65824F	6 1/2"	55"	204.00	YARD	
LCF65604F	2"	56"	260.00	YARD		LCF65825F	6 1/2"	55"	204.00	YARD	
LCF65608F	1/4"	54"	216.00	YARD	40	LCF65827F		55"	204.00	YARD	39
LCF65609F	1/4"	54"	208.00	YARD		LCF65830F		55"	204.00	YARD	
LCF65610F		54"	224.00	YARD	36	LCF65831F		55"	204.00	YARD	
LCF65612F	1/8"	54"	208.00	YARD	38	LCF65833F		55"	204.00	YARD	
LCF65613F	1/8"	54"	208.00	YARD		LCF65834F		55"	204.00	YARD	
LCF65614F	6 3/4"	54"	200.00	YARD	39	LCF65835F		55"	204.00	YARD	
LCF65615F	6 3/4"	54"	200.00	YARD		LCF65836F		55"	204.00	YARD	
LCF65617F	28 3/8"	54"	228.00	YARD		LCF65838F		55"	204.00	YARD	
LCF65618F		54"	184.00	YARD	30	LCF65839F		55"	204.00	YARD	
LCF65619F		54"	184.00	YARD	31	LCF65841F	7 1/8"	55"	204.00	YARD	
LCF65623F		54"	216.00	YARD		LCF65843F	7 1/8"	55"	204.00	YARD	40
LCF65624F		54"	224.00	YARD	37	LCF65844F	7 1/8"	55"	204.00	YARD	
LCF65625F	27"	54"	84.00	YARD	23	LCF65845F	2 7/8"	55"	204.00	YARD	
LCF65627F		51"	84.00	YARD		LCF65846F	2 7/8"	55"	204.00	YARD	46
LCF65630F	36"	54"	92.00	YARD	25	LCF65847F	2 7/8"	55"	204.00	YARD	
LCF65638F	15 1/8"	54"	244.00	YARD	45	LCF65848F	2 7/8"	55"	196.00	YARD	
LCF65778F	27"	59"	236.00	YARD	55	LCF65851F	2 7/8"	55"	204.00	YARD	
LCF65779F		53"	208.00	YARD		LCF65852F	2 7/8"	55"	196.00	YARD	
LCF65780F	8"	56"	208.00	YARD	41	LCF65853F	2 7/8"	55"	204.00	YARD	
LCF65781F	1/4"	53"	208.00	YARD	34	LCF65857F		55"	204.00	YARD	
LCF65782F	6"	54"	144.00	YARD	28	LCF65858F		55"	204.00	YARD	
LCF65783F	6"	54"	144.00	YARD	28	LCF65860F		55"	204.00	YARD	
LCF65784F	1 1/2"	54"	144.00	YARD	26	LCF65862F		55"	204.00	YARD	
LCF65785F	1 1/2"	54"	144.00	YARD		LCF65863F		55"	204.00	YARD	
LCF65786F	1 1/2"	54"	144.00	YARD		LCF65864F		55"	204.00	YARD	
LCF65787F	7"	56"	168.00	YARD		LCF65865F		55"	204.00	YARD	42
LCF65788F	7"	56"	168.00	YARD	34	LCF65871F	4 1/2"	59"	228.00	YARD	
LCF65789F	7"	56"	168.00	YARD	34	LCF65872F		53"	208.00	YARD	38
LCF65790F	7"	56"	168.00	YARD	34	LCF65873F		55"	208.00	YARD	
LCF65791F	7"	56"	168.00	YARD	34	LCF65874F		55"	208.00	YARD	34
LCF65792F	7"	56"	168.00	YARD	34	LCF65875F		54"	200.00	YARD	34
LCF65793F	1/8"	55"	176.00	YARD	31	LCF65876F		54"	200.00	YARD	
LCF65794F	1/8"	55"	176.00	YARD	28	LCF65877F		59"	230.00	YARD	
LCF65795F	1/8"	55"	176.00	YARD		LCF65879F		59"	230.00	YARD	
LCF65796F	15"	56"	176.00	YARD	34	LCF65880F		59"	230.00	YARD	34
LCF65797F	15"	56"	176.00	YARD	38	LCF65881F		57"	88.00	YARD	
LCF65798F	15"	56"	176.00	YARD	38	LCF65882F		57"	88.00	YARD	
LCF65799F	15"	56"	176.00	YARD	36	LCF65883F	10"	54"	208.00	YARD	41
LCF65800F	15"	56"	176.00	YARD		LCF65884F	10"	54"	208.00	YARD	46
LCF65801F	7 1/4"	56"	160.00	YARD		LCF65885F	4 1/2"	54"	208.00	YARD	38
LCF65802F	7 1/4"	56"	160.00	YARD	34	LCF65887F		56"	192.00	YARD	34
LCF65803F	7 1/4"	56"	160.00	YARD	34	LCF65888F		56"	192.00	YARD	34
LCF65804F		55"	160.00	YARD	28	LCF65889F		56"	192.00	YARD	
LCF65805F		55"	160.00	YARD	28	LCF65890F		56"	192.00	YARD	34
LCF65806F		55"	160.00	YARD	28	LCF65891F		56"	192.00	YARD	34
LCF65807F		55"	160.00	YARD	28	LCF65892F		56"	192.00	YARD	34
LCF65808F		55"	160.00	YARD		LCF65893F	9 1/2"	55"	208.00	YARD	41
LCF65809F		55"	180.00	YARD	34	LCF65912F	40"	55"	200.00	YARD	
LCF65810F		55"	180.00	YARD	34	LCF65913F	40"	55"	200.00	YARD	43
LCF65811F	9 1/2"	55"	208.00	YARD	41	LCF65914F	40"	55"	200.00	YARD	

Prices herein quoted are suggested retail. Prices are subject to change without notice. All shipping and special processing charges are additional.

US Retail Price List - August 2016

Pattern	Repeat	Width	Price	UOM	Grade	Pattern	Repeat	Width	Price	UOM	Grade
LCF65915F	40"	55"	200.00	YARD		LCF66005F	6 1/4"	55"	196.00	YARD	38
LCF65916F	18"	54"	116.00	YARD	29	LCF66006F	6 1/4"	55"	196.00	YARD	
LCF65917F	18"	54"	116.00	YARD		LCF66007F		55"	196.00	YARD	35
LCF65921F		55"	176.00	YARD	36	LCF66008F		54"	176.00	YARD	30
LCF65922F		55"	212.00	YARD	38	LCF66009F	24 1/2"	55"	190.00	YARD	
LCF65924F	2"	55"	160.00	YARD	34	LCF66010F	24 1/2"	55"	190.00	YARD	36
LCF65925F		54"	190.00	YARD	28	LCF66109F		54"	172.00	YARD	28
LCF65926F	36"	55"	168.00	YARD	31	LCF66110F		54"	172.00	YARD	
LCF65928F	15 1/2"	57"	212.00	YARD		LCF66111F		54"	112.00	YARD	
LCF65930F		54"	160.00	YARD	25	LCF66112F		54"	112.00	YARD	20
LCF65931F		55"	192.00	YARD	37	LCF66113F		54"	164.00	YARD	
LCF65932F		59"	132.00	YARD	27	LCF66114F		54"	164.00	YARD	
LCF65933F		54"	192.00	YARD	34	LCF66115F		54"	164.00	YARD	36
LCF65934F		54"	192.00	YARD	34	LCF66116F	30"	54"	196.00	YARD	30
LCF65935F		55"	168.00	YARD		LCF66117F	30"	54"	196.00	YARD	28
LCF65936F		118"	304.00	YARD		LCF66118F	30"	54"	196.00	YARD	
LCF65937F	4 1/8"	54"	104.00	YARD		LCF66119F	8"	54"	172.00	YARD	30
LCF65938F	1/8"	54"	104.00	YARD	17	LCF66120F	8"	54"	172.00	YARD	
LCF65939F		59"	192.00	YARD		LCF66121F		57"	188.00	YARD	
LCF65940F		59"	204.00	YARD	37	LCF66122F		57"	188.00	YARD	
LCF65942F		54"	120.00	YARD		LCF66123F		57"	188.00	YARD	35
LCF65943F		54"	176.00	YARD		LCF66124F		57"	188.00	YARD	
LCF65944F		54"	180.00	YARD	32	LCF66125F		54"	144.00	YARD	
LCF65945F		55"	204.00	YARD	29	LCF66126F		54"	144.00	YARD	29
LCF65946F	6 5/8"	53"	212.00	YARD	52	LCF66127F		54"	144.00	YARD	
LCF65947F		55"	204.00	YARD	39	LCF66128F		56"	192.00	YARD	31
LCF65948F		55"	204.00	YARD		LCF66129F		56"	192.00	YARD	
LCF65949F		54"	132.00	YARD	24	LCF66130F		56"	192.00	YARD	
LCF65950F		54"	132.00	YARD	24	LCF66131F		56"	192.00	YARD	
LCF65951F		54"	160.00	YARD	25	LCF66132F	3/8"	55"	204.00	YARD	38
LCF65952F		55"	104.00	YARD	19	LCF66135F	1/8"	54"	136.00	YARD	26
LCF65954F		55"	170.00	YARD	34	LCF66136F	2"	54"	160.00	YARD	
LCF65955F	6 3/4"	54"	112.00	YARD		LCF66137F	2"	54"	160.00	YARD	
LCF65956F		54"	220.00	YARD		LCF66138F	2"	54"	160.00	YARD	28
LCF65972F	24 1/2"	55"	190.00	YARD	36	LCF66139F	2"	54"	160.00	YARD	
LCF65973F	24 1/2"	55"	190.00	YARD		LCF66140F		55"	236.00	YARD	45
LCF65974F	25"	55"	166.00	YARD		LCF66141F		55"	236.00	YARD	
LCF65975F		54"	180.00	YARD	31	LCF66142F	30"	51"	196.00	YARD	
LCF65976F	37"	57"	284.00	YARD		LCF66143F	30"	51"	220.00	YARD	66
LCF65977F		55"	204.00	YARD	39	LCF66146F	32"	54"	236.00	YARD	57
LCF65978F		55"	204.00	YARD	37	LCF66147F	32"	54"	236.00	YARD	55
LCF65979F	3/4"	55"	236.00	YARD		LCF66148F	32"	54"	236.00	YARD	60
LCF65980F		54"	190.00	YARD		LCF66149F	32"	54"	236.00	YARD	
LCF65983F	22"	55"	256.00	YARD		LCF66150F		56"	192.00	YARD	
LCF65984F	22"	55"	256.00	YARD	60	LCF66151F	37"	59"	384.00	YARD	90
LCF65985F		54"	188.00	YARD	36	LCF66152F	37"	59"	384.00	YARD	96
LCF65986F	5 1/2"	54"	236.00	YARD	45	LCF66153F	37"	59"	384.00	YARD	
LCF65987F		54"	152.00	YARD	26	LCF66154F	18"	54"	100.00	YARD	
LCF65988F		54"	136.00	YARD	31	LCF66155F	18"	54"	100.00	YARD	26
LCF65989F	28"	55"	172.00	YARD		LCF66156F	32"	54"	104.00	YARD	
LCF65990F		62"	244.00	YARD	46	LCF66157F	32"	54"	104.00	YARD	26
LCF65991F		62"	244.00	YARD		LCF66158F		55"	104.00	YARD	18
LCF65992F	1/2"	54"	228.00	YARD	43	LCF66159F		55"	104.00	YARD	18
LCF65993F	1/2"	54"	228.00	YARD	47	LCF66160F		55"	104.00	YARD	18
LCF65994F		54"	188.00	YARD		LCF66161F		55"	104.00	YARD	
LCF65996F	2"	53"	190.00	YARD		LCF66162F		55"	104.00	YARD	
LCF65997F		50"	156.00	YARD		LCF66163F		55"	104.00	YARD	17
LCF65999F		55"	204.00	YARD		LCF66164F		55"	100.00	YARD	
LCF66000F		55"	204.00	YARD		LCF66165F		55"	100.00	YARD	
LCF66001F	7"	53"	212.00	YARD	47	LCF66166F		55"	104.00	YARD	17
LCF66002F	7"	53"	212.00	YARD	47	LCF66167F		54"	160.00	YARD	
LCF66003F	3 1/4"	55"	200.00	YARD	39	LCF66168F		54"	160.00	YARD	
LCF66004F		57"	220.00	YARD	36	LCF66169F		54"	160.00	YARD	

Prices herein quoted are suggested retail. Prices are subject to change without notice. All shipping and special processing charges are additional.

US Retail Price List - August 2016

Pattern	Repeat	Width	Price	UOM	Grade	Pattern	Repeat	Width	Price	UOM	Grade
LCF66170F		54"	160.00	YARD		LCF66416F		59"	216.00	YARD	
LCF66171F		54"	160.00	YARD		LCF66418F		55"	280.00	YARD	
LCF66172F		54"	160.00	YARD	27	LCF66419F		55"	384.00	YARD	
LCF66173F		55"	204.00	YARD		LCF66420F		59"	124.00	YARD	
LCF66174F		55"	204.00	YARD		LCF66421F	1 1/4"	59"	124.00	YARD	
LCF66175F		55"	204.00	YARD	35	LCF66422F	2 3/8"	55"	96.00	YARD	
LCF66176F		55"	204.00	YARD	35	LCF66423F		55"	84.00	YARD	
LCF66254F	37"	59"	384.00	YARD	90	LCF66424F		55"	84.00	YARD	
LCF66255F		56"	192.00	YARD		LCF66425F		55"	168.00	YARD	
LCF66256F		56"	192.00	YARD		LCF66426F	3 1/4"	54"	58.00	YARD	
LCF66257F		56"	192.00	YARD	31	LCF66427F	2"	54"	58.00	YARD	
LCF66258F		56"	192.00	YARD		LCF66428F		59"	176.00	YARD	
LCF66260F		55"	104.00	YARD	18	LCF66429F		59"	124.00	YARD	
LCF66261F		55"	104.00	YARD		LCF66430F		59"	124.00	YARD	
LCF66262F		56"	192.00	YARD		LCF66431F	7/8"	55"	94.00	YARD	
LCF66275F		57"	188.00	YARD	35	LCF66432F		55"	88.00	YARD	
LCF66276F		57"	188.00	YARD	35	LCF66433F		54"	76.00	YARD	
LCF66277F		57"	188.00	YARD	35	LCF66434F		54"	76.00	YARD	
LCF66356F		54"	124.00	YARD	22	LCF66435F		118"	204.00	YARD	
LCF66357F		54"	124.00	YARD	23	LCF66436F	3"	118"	180.00	YARD	
LCF66358F		54"	124.00	YARD		LCF66437F	1 1/4"	120"	184.00	YARD	
LCF66359F		54"	124.00	YARD		LCF66440F		122"	136.00	YARD	
LCF66360F		54"	124.00	YARD		LCF66441F	5 5/8"	118"	248.00	YARD	
LCF66361F		54"	124.00	YARD		LCF66442F		118"	248.00	YARD	
LCF66362F		54"	124.00	YARD	23	LCF66462F		57"	88.00	YARD	
LCF66363F		54"	124.00	YARD		LCF66518F	25"	55"	92.00	YARD	19
LCF66364F		54"	124.00	YARD		LCF66519F	25"	55"	92.00	YARD	19
LCF66365F		54"	124.00	YARD	20	LCF66520F	13 1/4"	54"	204.00	YARD	
LCF66366F		54"	124.00	YARD	20	LCF66521F	13 1/4"	54"	204.00	YARD	
LCF66367F		54"	124.00	YARD		LCF66522F	30"	54"	112.00	YARD	27
LCF66368F		54"	124.00	YARD		LCF66523F	30"	54"	112.00	YARD	27
LCF66369F		54"	124.00	YARD		LCF66524F	25 1/4"	54"	80.00	YARD	
LCF66370F		54"	124.00	YARD		LCF66525F	25 1/4"	54"	80.00	YARD	
LCF66371F		54"	124.00	YARD		LCF66526F	27"	54"	156.00	YARD	37
LCF66372F		54"	124.00	YARD	20	LCF66527F	13 1/4"	54"	116.00	YARD	
LCF66373F		54"	124.00	YARD		LCF66528F	13 1/4"	54"	116.00	YARD	22
LCF66374F		54"	124.00	YARD		LCF66529F	40"	55"	200.00	YARD	43
LCF66375F		54"	124.00	YARD		LCF66530F	16 1/2"	59"	380.00	YARD	
LCF66376F		54"	124.00	YARD	20	LCF66531F	16 1/2"	59"	380.00	YARD	
LCF66377F		54"	124.00	YARD	20	LCF66532F	16 1/2"	59"	380.00	YARD	72
LCF66378F		54"	124.00	YARD		LCF66533F	16"	55"	364.00	YARD	
LCF66380F		54"	124.00	YARD		LCF66534F	16"	55"	364.00	YARD	
LCF66381F		54"	124.00	YARD		LCF66535F	16"	55"	364.00	YARD	
LCF66382F		54"	124.00	YARD	21	LCF66536F	16"	55"	364.00	YARD	69
LCF66383F		54"	124.00	YARD	21	LCF66537F	16"	55"	364.00	YARD	
LCF66384F		54"	124.00	YARD	21	LCF66538F	14"	54"	248.00	YARD	
LCF66385F		54"	124.00	YARD	21	LCF66539F	14"	54"	248.00	YARD	
LCF66386F		54"	124.00	YARD	21	LCF66540F	14"	54"	248.00	YARD	
LCF66387F		54"	184.00	YARD	31	LCF66541F	14"	54"	248.00	YARD	
LCF66388F		54"	184.00	YARD		LCF66542F	14"	54"	248.00	YARD	
LCF66389F		54"	184.00	YARD		LCF66543F	28"	55"	228.00	YARD	
LCF66390F		54"	184.00	YARD		LCF66544F	28"	55"	228.00	YARD	
LCF66391F		54"	184.00	YARD		LCF66545F	28"	55"	228.00	YARD	
LCF66392F		54"	184.00	YARD		LCF66546F	28"	55"	228.00	YARD	
LCF66393F		54"	184.00	YARD		LCF66547F	28"	55"	228.00	YARD	
LCF66394F		54"	184.00	YARD	31	LCF66548F	28"	55"	228.00	YARD	
LCF66395F		54"	198.00	YARD	27	LCF66549F	19 1/4"	54"	504.00	YARD	
LCF66396F		54"	198.00	YARD		LCF66550F	19 1/4"	54"	504.00	YARD	
LCF66397F		54"	198.00	YARD	27	LCF66551F	12"	1/2"	248.00	YARD	47
LCF66398F		54"	198.00	YARD		LCF66553F	47"	54"	176.00	YARD	
LCF66413F	1/4"	59"	216.00	YARD		LCF66554F	47"	54"	176.00	YARD	37
LCF66414F	1/4"	59"	216.00	YARD		LCF66555F	6 1/2"	55"	316.00	YARD	
LCF66415F		59"	212.00	YARD		LCF66564F	28 3/4"	53"	160.00	YARD	

Prices herein quoted are suggested retail. Prices are subject to change without notice. All shipping and special processing charges are additional.

US Retail Price List - August 2016

Pattern	Repeat	Width	Price	UOM	Grade	Pattern	Repeat	Width	Price	UOM	Grade		
LCF66567F	60	7/8"	54"	248.00	YARD	41	LCF66633F	1/2"	54"	132.00	YARD		
LCF66568F			54"	248.00	YARD	41	LCF66634F	15	3/4"	64"	160.00	YARD	
LCF66569F	7	1/2"	1/2"	248.00	YARD	43	LCF66635F		5"	54"	160.00	YARD	
LCF66570F			53"	248.00	YARD	43	LCF66636F	1	3/4"	54"	90.00	YARD	18
LCF66571F			56"	124.00	YARD	20	LCF66637F	1	3/4"	54"	88.00	YARD	21
LCF66572F			55"	124.00	YARD	20	LCF66638F	26"	1/2"	160.00	YARD	36	
LCF66573F			55"	100.00	YARD	15	LCF66639F	14"	57"	160.00	YARD		
LCF66574F	3	3/4"	54"	100.00	YARD		LCF66640F	14"	57"	160.00	YARD	37	
LCF66575F		36"	55"	100.00	YARD	15	LCF66641F	5"	55"	76.00	YARD		
LCF66576F		36"	55"	212.00	YARD	37	LCF66642F	5"	55"	76.00	YARD		
LCF66577F		36"	55"	188.00	YARD	43	LCF66643F		54"	212.00	YARD		
LCF66579F			54"	146.00	YARD	30	LCF66644F		54"	212.00	YARD		
LCF66580F			54"	152.00	YARD	33	LCF66646F		55"	216.00	YARD		
LCF66581F			54"	186.00	YARD		LCF66738F		57"	72.00	YARD	11	
LCF66582F		4"	55"	186.00	YARD		LCF66739F		57"	72.00	YARD		
LCF66583F			54"	88.00	YARD	18	LCF66758F	21"	57"	248.00	YARD	55	
LCF66584F			54"	88.00	YARD	18	LCF66759F	21"	57"	248.00	YARD		
LCF66585F			57"	160.00	YARD	23	LCF66760F	21"	57"	248.00	YARD		
LCF66586F			57"	160.00	YARD	23	LCF66761F	24	1/4"	54"	248.00	YARD	56
LCF66587F	15	1/2"	56"	204.00	YARD		LCF66762F	24	1/4"	54"	248.00	YARD	54
LCF66588F			54"	204.00	YARD	40	LCF66763F		55"	204.00	YARD		
LCF66589F			54"	224.00	YARD	44	LCF66764F		59"	52"	184.00	YARD	
LCF66590F			51"	224.00	YARD	44	LCF66765F		59"	52"	184.00	YARD	
LCF66591F			51"	222.00	YARD		LCF66766F		59"	52"	184.00	YARD	
LCF66592F			51"	222.00	YARD	37	LCF66767F		31"	55"	248.00	YARD	54
LCF66593F			51"	264.00	YARD	43	LCF66768F	6	3/4"	54"	184.00	YARD	31
LCF66594F			51"	224.00	YARD		LCF66769F	21	1/2"	57"	248.00	YARD	50
LCF66595F		26"	1/2"	224.00	YARD		LCF66770F	21	1/2"	57"	248.00	YARD	50
LCF66596F			55"	160.00	YARD	26	LCF66771F	50	1/4"	51"	128.00	YARD	
LCF66597F			55"	160.00	YARD	26	LCF66772F	50	1/4"	51"	128.00	YARD	
LCF66598F			55"	116.00	YARD	24	LCF66773F	50	1/4"	51"	128.00	YARD	
LCF66599F			55"	216.00	YARD	47	LCF66774F		21"	57"	248.00	YARD	
LCF66600F	10	1/2"	56"	200.00	YARD	35	LCF66775F		21"	57"	248.00	YARD	50
LCF66603F			54"	160.00	YARD		LCF66776F		23"	52"	196.00	YARD	
LCF66604F		1/2"	54"	116.00	YARD	17	LCF66777F		23"	52"	196.00	YARD	
LCF66605F			57"	116.00	YARD		LCF66778F		14"	51"	192.00	YARD	44
LCF66606F			54"	124.00	YARD		LCF66779F		54"	120.00	YARD		
LCF66607F			55"	124.00	YARD		LCF66780F		1/2"	140.00	YARD		
LCF66608F			55"	124.00	YARD		LCF66781F		1/2"	140.00	YARD		
LCF66609F			54"	192.00	YARD		LCF66782F		1/2"	140.00	YARD		
LCF66610F			54"	168.00	YARD	35	LCF66783F	1	1/2"	1/2"	120.00	YARD	
LCF66611F			59"	168.00	YARD		LCF66784F		29"	55"	240.00	YARD	
LCF66612F		3/8"	55"	168.00	YARD		LCF66785F		36"	1/2"	248.00	YARD	54
LCF66613F		3/8"	55"	88.00	YARD		LCF66786F		36"	1/2"	248.00	YARD	
LCF66614F		3/8"	55"	176.00	YARD	42	LCF66787F			54"	80.00	YARD	15
LCF66615F			54"	176.00	YARD		LCF66788F		36"	1/2"	248.00	YARD	
LCF66616F			54"	176.00	YARD		LCF66789F	6	3/4"	54"	184.00	YARD	31
LCF66617F	17	3/4"	55"	164.00	YARD		LCF66790F	1	1/2"	1/2"	120.00	YARD	
LCF66618F	17	3/4"	55"	212.00	YARD		LCF66791F			54"	88.00	YARD	
LCF66619F			54"	92.00	YARD		LCF66792F	1	1/4"	55"	72.00	YARD	12
LCF66620F			54"	78.00	YARD	17	LCF66793F	1	1/4"	55"	72.00	YARD	
LCF66621F			54"	78.00	YARD	17	LCF66794F			1/2"	120.00	YARD	
LCF66622F	6	1/2"	54"	244.00	YARD		LCF66795F		19"	53"	160.00	YARD	40
LCF66623F	6	1/2"	54"	188.00	YARD		LCF66796F		19"	53"	160.00	YARD	
LCF66624F	19	1/4"	54"	188.00	YARD		LCF66797F		21"	54"	88.00	YARD	
LCF66625F			54"	76.00	YARD	12	LCF66798F		21"	54"	88.00	YARD	
LCF66626F	28	3/4"	54"	76.00	YARD		LCF66801F			54"	100.00	YARD	
LCF66627F		25"	56"	76.00	YARD		LCF66803F		1/8"	55"	140.00	YARD	
LCF66628F		25"	56"	84.00	YARD	12	LCF66804F		1/8"	55"	140.00	YARD	
LCF66629F	25	3/4"	1/2"	144.00	YARD		LCF66805F		1/8"	55"	140.00	YARD	
LCF66630F			55"	144.00	YARD		LCF66806F			54"	80.00	YARD	
LCF66631F			55"	132.00	YARD		LCF66807F			54"	100.00	YARD	
LCF66632F			55"	132.00	YARD		LCF66808F		3"	54"	80.00	YARD	13

Prices herein quoted are suggested retail. Prices are subject to change without notice. All shipping and special processing charges are additional.

US Retail Price List - August 2016

Pattern	Repeat	Width	Price	UOM	Grade	Pattern	Repeat	Width	Price	UOM	Grade
LCF66809F	3"	54"	80.00	YARD		LCF66981F		54"	88.00	YARD	
LCF66810F		54"	80.00	YARD	12	LCF66982F		52"	88.00	YARD	
LCF66811F		54"	80.00	YARD		LCF66983F		52"	88.00	YARD	
LCF66812F		54"	80.00	YARD		LCF66984F		54"	100.00	YARD	
LCF66813F		54"	80.00	YARD		LCF66985F		54"	100.00	YARD	
LCF66814F		54"	80.00	YARD	12	LCF66986F		54"	100.00	YARD	
LCF66815F		54"	80.00	YARD		LCF66987F		54"	140.00	YARD	
LCF66816F		54"	88.00	YARD		LCF66988F		54"	140.00	YARD	
LCF66817F		54"	88.00	YARD		LCF66989F		54"	140.00	YARD	
LCF66818F		54"	100.00	YARD	17	LCF66990F		54"	140.00	YARD	
LCF66821F		55"	88.00	YARD	19	LCF66991F	1/4"	54"	124.00	YARD	26
LCF66822F		54"	100.00	YARD		LCF66993F	27"	54"	108.00	YARD	
LCF66824F		54"	160.00	YARD		LCF67065F		54"	100.00	YARD	
LCF66825F	1 1/2"	56"	88.00	YARD	20	LCF67070F	7"	54"	128.00	YARD	22
LCF66826F	1 1/2"	56"	88.00	YARD		LCF67071F	7"	54"	128.00	YARD	
LCF66827F		55"	88.00	YARD		LCF67072F	1 3/4"	53"	128.00	YARD	
LCF66828F	1/4"	55"	140.00	YARD		LCF67073F	1 3/4"	53"	128.00	YARD	26
LCF66829F	1/4"	55"	140.00	YARD	24	LCF67075F	3"	55"	220.00	YARD	
LCF66833F		47"	180.00	YARD		LCF67076F	3"	55"	220.00	YARD	41
LCF66880F	3/4"	53"	116.00	YARD	20	LCF67077F	3"	55"	220.00	YARD	41
LCF66881F	2 1/4"	53"	116.00	YARD	27	LCF67078F		55"	220.00	YARD	
LCF66882F	5"	1/2"	116.00	YARD	29	LCF67079F		55"	220.00	YARD	43
LCF66883F		53"	80.00	YARD	21	LCF67080F		55"	220.00	YARD	43
LCF66884F		53"	80.00	YARD	21	LCF67081F	21"	57"	248.00	YARD	48
LCF66885F		53"	80.00	YARD	21	LCF67082F	3 3/4"	54"	160.00	YARD	35
LCF66886F		54"	96.00	YARD	22	LCF67083F		54"	200.00	YARD	37
LCF66887F		54"	96.00	YARD	22	LCF67085F		52"	176.00	YARD	35
LCF66888F	19"	1/2"	160.00	YARD	31	LCF67086F		52"	176.00	YARD	27
LCF66889F	19"	1/2"	160.00	YARD	35	LCF67087F		54"	170.00	YARD	32
LCF66890F	19"	1/2"	160.00	YARD	31	LCF67088F		54"	170.00	YARD	32
LCF66891F	21"	54"	88.00	YARD		LCF67089F	28 3/4"	53"	176.00	YARD	42
LCF66892F	21"	54"	88.00	YARD		LCF67090F	28 3/4"	53"	176.00	YARD	42
LCF66893F	21"	54"	88.00	YARD		LCF67091F		54"	160.00	YARD	27
LCF66894F	3/8"	54"	100.00	YARD		LCF67092F	59"	53"	244.00	YARD	
LCF66898F		55"	96.00	YARD	16	LCF67093F		54"	136.00	YARD	21
LCF66899F	54"	55"	128.00	YARD		LCF67094F		54"	124.00	YARD	19
LCF66900F		55"	96.00	YARD		LCF67095F		54"	124.00	YARD	19
LCF66901F	5/8"	55"	96.00	YARD		LCF67096F		57"	188.00	YARD	35
LCF66903F		55"	96.00	YARD	16	LCF67097F		57"	188.00	YARD	29
LCF66904F		55"	96.00	YARD	16	LCF67098F	5 1/8"	59"	192.00	YARD	33
LCF66905F		55"	96.00	YARD	18	LCF67099F	5 1/8"	59"	192.00	YARD	36
LCF66906F		55"	96.00	YARD	16	LCF67100F		55"	144.00	YARD	
LCF66907F		55"	96.00	YARD	16	LCF67101F		55"	164.00	YARD	33
LCF66908F	6 3/4"	55"	80.00	YARD	13	LCF67102F		55"	164.00	YARD	28
LCF66909F	1"	52"	212.00	YARD		LCF67105F	26"	1/2"	216.00	YARD	
LCF66910F	19 1/4"	55"	132.00	YARD	25	LCF67106F	7 1/4"	53"	200.00	YARD	
LCF66911F	19 1/4"	55"	132.00	YARD	29	LCF67107F		55"	180.00	YARD	33
LCF66915F	18"	54"	164.00	YARD		LCF67108F	7"	53"	224.00	YARD	47
LCF66916F	18"	54"	164.00	YARD		LCF67112F	17 1/2"	54"	204.00	YARD	45
LCF66917F	18"	54"	164.00	YARD		LCF67122F	1 1/4"	56"	260.00	YARD	
LCF66918F	39 1/2"	53"	200.00	YARD	54	LCF67123F		57"	340.00	YARD	58
LCF66919F	39 1/2"	53"	200.00	YARD	54	LCF67124F	11"	122"	320.00	YARD	
LCF66920F	39 1/2"	53"	200.00	YARD	54	LCF67125F		122"	280.00	YARD	
LCF66921F	1/4"	54"	124.00	YARD	26	LCF67126F	6 1/4"	55"	196.00	YARD	
LCF66923F		54"	140.00	YARD		LCF67127F	6 1/4"	55"	196.00	YARD	
LCF66924F	27"	54"	108.00	YARD		LCF67128F		52"	176.00	YARD	
LCF66943F	1/2"	88.00	YARD			LCF67129F		52"	176.00	YARD	
LCF66944F	56"	88.00	YARD			LCF67130F		52"	176.00	YARD	
LCF66945F	1/2"	88.00	YARD			LCF67131F		54"	170.00	YARD	
LCF66946F	1/2"	88.00	YARD			LCF67132F		55"	260.00	YARD	
LCF66960F	60"	72.00	YARD			LCF67133F		55"	260.00	YARD	
LCF66979F	57"	72.00	YARD			LCF67134F	29"	52"	280.00	YARD	
LCF66980F	57"	72.00	YARD			LCF67135F	29"	52"	280.00	YARD	

Prices herein quoted are suggested retail. Prices are subject to change without notice. All shipping and special processing charges are additional.

US Retail Price List - August 2016

Pattern	Repeat	Width	Price	UOM	Grade	Pattern	Repeat	Width	Price	UOM	Grade	
LCF67136F	29"	52"	280.00	YARD		LCF67349F		54"	184.00	YARD	37	
LCF67137F	1/4"	55"	176.00	YARD		LCF67350F	4 3/4"	54"	192.00	YARD	38	
LCF67139F	23"	54"	230.00	YARD		LCF67351F	2 3/4"	54"	164.00	YARD	36	
LCF67140F		56"	160.00	YARD		LCF67352F	2"	54"	196.00	YARD	39	
LCF67141F		56"	160.00	YARD	25	LCF67353F	2"	54"	196.00	YARD		
LCF67142F		56"	160.00	YARD		LCF67354F	5"	54"	196.00	YARD	42	
LCF67145F	17 1/2"	54"	204.00	YARD		LCF67356F	27"	54"	196.00	YARD	48	
LCF67146F	17 1/2"	54"	204.00	YARD		LCF67357F	27"	54"	196.00	YARD		
LCF67147F		56"	204.00	YARD		LCF67358F	27"	54"	196.00	YARD	48	
LCF67148F	23 1/2"	1/2"	316.00	YARD		LCF67386F		58"	196.00	YARD	32	
LCF67150F	24 1/4"	1/2"	272.00	YARD		LCF67387F		1/2"	196.00	YARD	39	
LCF67151F	24 1/4"	1/2"	272.00	YARD		LCF67388F		1/2"	196.00	YARD	33	
LCF67152F	30"	54"	204.00	YARD		LCF67389F		58"	166.00	YARD	26	
LCF67153F	30"	54"	204.00	YARD		LCF67390F		57"	196.00	YARD		
LCF67154F	11 1/4"	59"	192.00	YARD		LCF67391F		57"	196.00	YARD		
LCF67155F	11 1/4"	59"	192.00	YARD		LCF67392F		57"	196.00	YARD		
LCF67156F	27"	55"	188.00	YARD		LCF67393F		57"	196.00	YARD	35	
LCF67157F	27"	55"	188.00	YARD		LCF67394F		57"	196.00	YARD		
LCF67158F	27"	55"	188.00	YARD		LCF67395F		57"	196.00	YARD		
LCF67159F		54"	188.00	YARD		LCF67396F		58"	196.00	YARD	30	
LCF67160F		54"	136.00	YARD		LCF67397F	3/8"	55"	228.00	YARD		
LCF67161F		54"	136.00	YARD		LCF67398F		1/2"	196.00	YARD		
LCF67162F	23"	54"	230.00	YARD		LCF67399F		1/2"	196.00	YARD	44	
LCF67232F	1/2"	54"	228.00	YARD		LCF67400F		1/2"	196.00	YARD		
LCF67238F		54"	172.00	YARD		LCF67401F		1/2"	196.00	YARD		
LCF67269F		55"	204.00	YARD	46	LCF67402F		1/2"	196.00	YARD	33	
LCF67294F	8 5/8"	54"	184.00	YARD	31	LCF67403F		1/2"	196.00	YARD		
LCF67295F	2 3/4"	54"	184.00	YARD	40	LCF67404F	3/8"	55"	228.00	YARD		
LCF67296F		60"	200.00	YARD		LCF67405F		55"	176.00	YARD	29	
LCF67299F		60"	200.00	YARD		LCF67406F		55"	176.00	YARD		
LCF67300F		60"	200.00	YARD		LCF67407F		55"	176.00	YARD		
LCF67302F		54"	176.00	YARD	35	LCF67408F		55"	176.00	YARD		
LCF67303F	1"	57"	216.00	YARD		LCF67409F		1/2"	196.00	YARD	33	
LCF67304F		55"	196.00	YARD	30	LCF67410F		1/2"	196.00	YARD		
LCF67305F		53"	196.00	YARD		LCF67411F		1/2"	196.00	YARD	33	
LCF67306F		53"	196.00	YARD	40	LCF67412F		1/2"	196.00	YARD		
LCF67307F		55"	196.00	YARD	39	LCF67413F		1/2"	196.00	YARD		
LCF67308F		55"	196.00	YARD	33	LCF67414F		1/2"	124.00	YARD		
LCF67309F		56"	196.00	YARD	39	LCF67415F		1/2"	124.00	YARD		
LCF67310F		56"	196.00	YARD		LCF67416F		56"	164.00	YARD		
LCF67311F	26"	54"	204.00	YARD	44	LCF67418F		56"	224.00	YARD		
LCF67312F	8 3/4"	54"	392.00	YARD	76	LCW07656W		27"	54.00	ROLL		
LCF67313F	8 3/4"	54"	392.00	YARD		LCW22133W	21"	27"	72.00	ROLL		
LCF67314F	23 3/4"	54"	184.00	YARD		LCW22213W	27"	27"	72.00	ROLL		
LCF67315F	23 3/4"	54"	184.00	YARD	37	LCW29327W		27"	58.00	ROLL		
LCF67316F	23 3/4"	54"	184.00	YARD		LCW30719W		27"	64.00	ROLL		
LCF67317F	23 3/4"	54"	184.00	YARD		LCW30722W		27"	60.00	ROLL		
LCF67326F		54"	176.00	YARD		LCW40596W	25 1/4"	27"	82.00	ROLL		
LCF67327F	8 5/8"	54"	184.00	YARD		LCW40607W		27"	54.00	ROLL		
LCF67328F		54"	176.00	YARD		LEAFAGE	18"	54"	79.80	YARD	12	
LCF67329F		54"	176.00	YARD		LEOKAT	25 1/2"	54"	119.00	YARD	22	
LCF67335F	5"	54"	196.00	YARD		LEOPARD	12 1/2"	59"	179.00	YARD		
LCF67336F		60"	200.00	YARD		LETS DANCE		54"	145.00	YARD	22	
LCF67337F		60"	200.00	YARD	31	LEYLA	27"	54"	79.00	YARD	11	
LCF67339F	2 3/4"	54"	184.00	YARD		LFY00851F		54"	112.00	YARD	29	
LCF67340F		54"	192.00	YARD	38	LFY02000F		54"	192.00	YARD	43	
LCF67341F		54"	184.00	YARD	37	LFY02002F		54"	192.00	YARD	43	
LCF67342F		54"	164.00	YARD	33	LFY02026F	10"	61"	316.00	YARD	68	
LCF67343F	3/8"	54"	204.00	YARD	35	LFY07505F	14"	54"	384.00	YARD	93	
LCF67344F	25"	54"	176.00	YARD	41	LFY07507F		54"	500.00	YARD	126	
LCF67345F		55"	192.00	YARD	43	LFY07618F		54"	112.00	YARD	22	
LCF67346F		55"	192.00	YARD	38	LFY08639F		27"	54"	200.00	YARD	46
LCF67348F	1/2"	54"	124.00	YARD		LFY09024F	15 1/4"	54"	304.00	YARD	68	

Prices herein quoted are suggested retail. Prices are subject to change without notice. All shipping and special processing charges are additional.

US Retail Price List - August 2016

Pattern	Repeat	Width	Price	UOM	Grade	Pattern	Repeat	Width	Price	UOM	Grade		
LFY09026F	14	1/2"	54"	648.00	YARD	145	LFY30450F	54"	292.00	YARD	63		
LFY09038F	3	1/2"	54"	300.00	YARD	59	LFY40121F	54"	108.00	YARD			
LFY09530F		22"	54"	328.00	YARD	76	LFY40161F	27"	54"	324.00	YARD	81	
LFY09531F		22"	54"	328.00	YARD	76	LFY40181F	27"	52"	236.00	YARD	60	
LFY10308F		27"	54"	144.00	YARD	36	LFY40272F	27"	52"	292.00	YARD	73	
LFY10633F		54"	168.00	YARD	39	LFY40397F		59"	364.00	YARD			
LFY10811F		59"	144.00	YARD	25	LFY40399F		59"	364.00	YARD	57		
LFY10820F		54"	192.00	YARD	44	LFY50000F	23	7/8"	59"	404.00	YARD	98	
LFY10823F		54"	168.00	YARD	39	LFY50001F	23	7/8"	59"	404.00	YARD	94	
LFY10824F		54"	224.00	YARD	52	LFY50002F	23	7/8"	59"	404.00	YARD	94	
LFY10825F		27"	54"	168.00	YARD	42	LFY50034F	20"	54"	268.00	YARD	69	
LFY10920F		54"	512.00	YARD	92	LFY50035F	20"	54"	268.00	YARD	65		
LFY12457F		32"	54"	224.00	YARD	45	LFY50036F	25	1/4"	54"	268.00	YARD	67
LFY12467F	25	1/4"	54"	224.00	YARD		LFY50039F	25	1/4"	54"	228.00	YARD	57
LFY13270F		54"	328.00	YARD	59	LFY50060F		53"	228.00	YARD	65		
LFY14604F	8	3/4"	59"	480.00	YARD	103	LFY50069F	5	1/2"	54"	224.00	YARD	
LFY17010F	3	1/2"	59"	240.00	YARD	51	LFY50102F	32"	54"	216.00	YARD	59	
LFY17029F	3	1/2"	55"	452.00	YARD		LFY50104F	32"	54"	216.00	YARD	54	
LFY17219F		54"	376.00	YARD	94	LFY50106F	25	1/4"	54"	248.00	YARD	66	
LFY17991F	13	1/2"	54"	184.00	YARD	48	LFY50108F	25	1/4"	51"	248.00	YARD	70
LFY19403F		55"	528.00	YARD	95	LFY50113F		54"	196.00	YARD	44		
LFY19406F		55"	528.00	YARD	95	LFY50120F	27"	54"	216.00	YARD			
LFY19466F		3"	59"	240.00	YARD	51	LFY50136F		54"	172.00	YARD	34	
LFY19489F		55"	528.00	YARD		LFY50147F	13	1/2"	54"	236.00	YARD	50	
LFY20310F	13	1/2"	59"	256.00	YARD	62	LFY50151F		54"	268.00	YARD	53	
LFY20647F		27"	55"	336.00	YARD	84	LFY50155F	6	1/4"	54"	400.00	YARD	
LFY20692F		54"	280.00	YARD	44	LFY50156F	6	1/4"	54"	400.00	YARD		
LFY21673F		54"	328.00	YARD	64	LFY50300F		60"	228.00	YARD	43		
LFY21705F		55"	528.00	YARD	95	LFY50301F		60"	228.00	YARD			
LFY21756F	4	1/2"	54"	224.00	YARD	49	LFY50302F		60"	228.00	YARD	41	
LFY21830F		18"	54"	256.00	YARD	67	LFY50303F		60"	228.00	YARD	41	
LFY21850F	25	1/4"	54"	160.00	YARD	31	LFY50304F		60"	228.00	YARD	41	
LFY21860F		27"	52"	192.00	YARD	50	LFY50306F		60"	228.00	YARD		
LFY22900F		54"	296.00	YARD		LFY50320F		57"	152.00	YARD			
LFY22903F		51"	248.00	YARD		LFY50340F		57"	296.00	YARD	53		
LFY22920F		55"	164.00	YARD		LFY50361F	33"	54"	700.00	YARD			
LFY24040F		55"	528.00	YARD	95	LFY50370F	27"	54"	108.00	YARD	25		
LFY24049F		55"	528.00	YARD		LFY50375F	27"	54"	108.00	YARD	25		
LFY24051F		55"	528.00	YARD	95	LFY50378F	27"	54"	112.00	YARD			
LFY24052F		55"	528.00	YARD	95	LFY50386F	27"	54"	224.00	YARD	52		
LFY24181F		51"	348.00	YARD	68	LFY50392F	2	7/8"	59"	400.00	YARD	88	
LFY24201F		54"	184.00	YARD		LFY50395F			384.00	YARD	103		
LFY24216F		54"	184.00	YARD	33	LFY50399F	26"	52"	504.00	YARD	117		
LFY24231F		54"	184.00	YARD	38	LFY50404F	23"	48"	344.00	YARD			
LFY24233F		58"	176.00	YARD		LFY50501F		57"	268.00	YARD			
LFY24234F		58"	176.00	YARD	37	LFY50502F	1/2"	57"	300.00	YARD			
LFY25136F		54"	224.00	YARD	49	LFY50504F	1/2"	57"	324.00	YARD	64		
LFY28840F		57"	80.00	YARD	14	LFY50506F		51"	300.00	YARD	70		
LFY29212F		56"	84.00	YARD	20	LFY50510F		51"	300.00	YARD	70		
LFY29220F		21"	57"	424.00	YARD	103	LFY50511F		51"	300.00	YARD		
LFY29516F		29"	53"	644.00	YARD		LFY50512F		58"	300.00	YARD	67	
LFY29575F		54"	124.00	YARD	24	LFY50513F		58"	300.00	YARD	67		
LFY29578F		54"	124.00	YARD	24	LFY50526F	33"	54"	700.00	YARD			
LFY29587F		54"	116.00	YARD		LFY50527F	33"	54"	700.00	YARD	176		
LFY29590F		54"	116.00	YARD	20	LFY50751F		55"	688.00	YARD			
LFY29603F		54"	124.00	YARD	24	LFY50752F		55"	688.00	YARD	123		
LFY29823F		27"	54"	212.00	YARD	49	LFY50753F		55"	688.00	YARD		
LFY29830F		27"	54"	212.00	YARD	53	LFY50754F		55"	688.00	YARD		
LFY30014F		52"	324.00	YARD	64	LFY50755F		55"	688.00	YARD			
LFY30046F		7/8"	54"	288.00	YARD	57	LFY50756F		55"	688.00	YARD	123	
LFY30049F		54"	364.00	YARD	65	LFY50757F		55"	688.00	YARD			
LFY30054F		54"	244.00	YARD		LFY50758F		55"	688.00	YARD	123		
LFY30064F		54"	332.00	YARD	59	LFY50761F		55"	688.00	YARD			

Prices herein quoted are suggested retail. Prices are subject to change without notice. All shipping and special processing charges are additional.

US Retail Price List - August 2016

Pattern	Repeat	Width	Price	UOM	Grade	Pattern	Repeat	Width	Price	UOM	Grade
LFY50762F		55"	688.00	YARD	123	LFY62520F		54"	144.00	YARD	30
LFY50763F		55"	688.00	YARD		LFY62526F		54"	152.00	YARD	
LFY50765F		55"	688.00	YARD		LFY62665F		55"	368.00	YARD	
LFY50766F		55"	688.00	YARD		LFY63006F	13 1/2"	54"	336.00	YARD	81
LFY50767F		55"	688.00	YARD		LFY63045F	27"	57"	452.00	YARD	
LFY60052F		54"	204.00	YARD		LFY63053F		52"	588.00	YARD	
LFY60054F		54"	304.00	YARD		LFY63058F		51"	676.00	YARD	133
LFY60067F		54"	304.00	YARD	66	LFY64003F		56"	280.00	YARD	44
LFY60068F	15 3/4"	53"	360.00	YARD	90	LFY64036F	30 1/2"	55"	344.00	YARD	104
LFY60069F	15 3/4"	53"	360.00	YARD	81	LFY64040F	10"	55"	236.00	YARD	48
LFY60074F		55"	404.00	YARD		LFY64042F		55"	492.00	YARD	97
LFY60075F		52"	628.00	YARD		LFY64047F		55"	396.00	YARD	71
LFY60079F		60"	84.00	YARD		LFY64050F	13 1/2"	55"	244.00	YARD	54
LFY60085F		55"	344.00	YARD		LFY64079F		55"	200.00	YARD	39
LFY60095F		55"	392.00	YARD		LFY64082F		55"	200.00	YARD	39
LFY60101F	13 1/2"	55"	304.00	YARD	73	LFY64088F	13 3/8"	55"	320.00	YARD	72
LFY60172F		54"	212.00	YARD	47	LFY64092F	13"	55"	496.00	YARD	121
LFY60456F		53"	228.00	YARD	53	LFY64094F	13"	55"	496.00	YARD	
LFY60458F		53"	228.00	YARD	59	LFY64096F		55"	344.00	YARD	67
LFY60460F		54"	104.00	YARD	20	LFY64099F	15 3/4"	55"	360.00	YARD	90
LFY60474F	57 1/2"	54"	512.00	YARD		LFY64100F		55"	208.00	YARD	
LFY60475F	57 1/2"	54"	512.00	YARD		LFY64101F		55"	176.00	YARD	34
LFY60478F	4 3/4"	55"	400.00	YARD	86	LFY64104F		55"	396.00	YARD	99
LFY60540F	14"	59"	376.00	YARD	91	LFY64106F		57"	260.00	YARD	51
LFY60591F			376.00	YARD	94	LFY64109F		55"	220.00	YARD	45
LFY60593F	34 1/2"	63"	392.00	YARD		LFY64110F		55"	304.00	YARD	60
LFY60621F		55"	480.00	YARD		LFY64119F		55"	228.00	YARD	62
LFY60626F		59"	364.00	YARD		LFY64120F	15 1/4"	55"	424.00	YARD	95
LFY60660F	31"	27"	728.00	YARD		LFY64122F		55"	384.00	YARD	95
LFY61141F	6 1/4"	59"	420.00	YARD	90	LFY64127F	35 1/2"	54"	204.00	YARD	
LFY61144F	10 1/4"	59"	364.00	YARD	78	LFY64128F		57"	200.00	YARD	
LFY61145F	14"	59"	348.00	YARD	84	LFY64131F		55"	265.34	YARD	
LFY61146F	8 7/8"	59"	420.00	YARD	90	LFY64132F		55"	312.00	YARD	
LFY61147F	8 1/2"	59"	332.00	YARD	71	LFY64160F	13 1/4"	55"	440.00	YARD	106
LFY61150F	8 1/4"	59"	364.00	YARD	78	LFY64162F	34 3/4"	55"	388.00	YARD	104
LFY61153F	8 1/4"	59"	312.00	YARD	67	LFY64165F		55"	220.00	YARD	55
LFY62074F		122"	492.00	YARD		LFY64172F		55"	208.00	YARD	52
LFY62076F		54"	248.00	YARD		LFY64176F	15 3/4"	55"	420.00	YARD	113
LFY62083F	25 1/4"	54"	308.00	YARD		LFY64177F	15 3/4"	55"	420.00	YARD	96
LFY62100F		59"	308.00	YARD	63	LFY64178F	19"	55"	408.00	YARD	93
LFY62101F	2"	59"	308.00	YARD	66	LFY64179F	19"	55"	408.00	YARD	
LFY62104F		59"	308.00	YARD	60	LFY64180F	24 3/4"	55"	364.00	YARD	88
LFY62105F		59"	308.00	YARD	63	LFY64308F		55"	264.00	ROLL	
LFY62108F		57"	376.00	YARD	74	LFY64309F	26 1/2"	55"	384.00	YARD	96
LFY62110F		57"	376.00	YARD	67	LFY64310F		59"	384.00	YARD	65
LFY62111F		57"	376.00	YARD	67	LFY64311F	60"	55"	584.00	YARD	104
LFY62117F		59"	364.00	YARD		LFY64313F		54"	264.00	YARD	55
LFY62118F		59"	364.00	YARD		LFY64315F		54"	492.00	YARD	88
LFY62120F		59"	308.00	YARD		LFY64318F		55"	264.00	YARD	41
LFY62122F		59"	308.00	YARD	60	LFY64322F	5"	59"	644.00	YARD	
LFY62123F		59"	308.00	YARD	60	LFY64326F		60"	384.00	YARD	73
LFY62125F	3"	59"	228.00	YARD	45	LFY64327F	24 3/4"	55"	1192.00	YARD	
LFY62136F		59"	228.00	YARD	45	LFY64328F		54"	292.00	YARD	49
LFY62138F		58"	228.00	YARD	45	LFY64331F		51"	332.00	YARD	65
LFY62139F		59"	228.00	YARD	45	LFY64332F		51"	332.00	YARD	65
LFY62142F	3"	55"	452.00	YARD	89	LFY64346F	13 1/2"	54"	336.00	YARD	65
LFY62143F	3"	55"	452.00	YARD	97	LFY64348F	24"	54"	424.00	YARD	103
LFY62407F		56"	340.00	YARD	54	LFY64630F	37"	54"	464.00	YARD	117
LFY62412F	1/2"	55"	400.00	YARD	66	LFY64635F		57"	296.00	YARD	41
LFY62435F		57"	352.00	YARD	69	LFY64636F	32"	54"	236.00	YARD	56
LFY62446F	1/2"	55"	400.00	YARD	68	LFY64637F	27"	54"	296.00	YARD	63
LFY62454F		55"	320.00	YARD	54	LFY64638F	18"	51"	292.00	YARD	62
LFY62503F		55"	260.00	YARD	52	LFY64640F		46"	1376.00	PNL	

Prices herein quoted are suggested retail. Prices are subject to change without notice. All shipping and special processing charges are additional.

US Retail Price List - August 2016

Pattern	Repeat	Width	Price	UOM	Grade	Pattern	Repeat	Width	Price	UOM	Grade
LFY64656F		55"	152.00	YARD		LFY65299F	24"	55"	316.00	YARD	67
LFY64658F		55"	296.00	YARD	44	LFY65300F		55"	480.00	YARD	
LFY64667F	8 1/2"	58"	424.00	YARD		LFY65301F	10 3/4"	53"	424.00	YARD	86
LFY64672F	15 3/4"	53"	360.00	YARD	84	LFY65303F		55"	316.00	YARD	52
LFY64684F		58"	160.00	YARD		LFY65307F		55"	296.00	YARD	
LFY64686F	24"	54"	176.00	YARD	35	LFY65311F		1 1/2"	492.00	YARD	98
LFY64688F	8 1/8"	59"	384.00	YARD		LFY65314F	59"	54"	572.00	YARD	
LFY64732F		55"	204.00	YARD	32	LFY65315F		55"	688.00	YARD	121
LFY64733F		55"	204.00	YARD	32	LFY65316F		56"	200.00	YARD	38
LFY64734F		55"	204.00	YARD	32	LFY65330F		54"	292.00	YARD	51
LFY64735F		55"	204.00	YARD	32	LFY65331F		55"	688.00	YARD	119
LFY64736F		55"	204.00	YARD	32	LFY65332F		55"	436.00	YARD	73
LFY64740F		55"	204.00	YARD	32	LFY65334F		27"	55"	216.00	YARD
LFY64741F		55"	204.00	YARD	32	LFY65336F	1 3/8"	56"	372.00	YARD	
LFY64744F		55"	204.00	YARD	32	LFY65337F	35 3/8"	54"	636.00	YARD	
LFY64746F		55"	204.00	YARD	32	LFY65338F	21 1/2"	51"	476.00	YARD	112
LFY64748F		55"	204.00	YARD	32	LFY65340F	23 1/4"	55"	988.00	YARD	239
LFY64749F		55"	204.00	YARD	32	LFY65454F		54"	92.00	YARD	16
LFY64753F		55"	204.00	YARD	32	LFY65455F		54"	92.00	YARD	
LFY64755F		55"	204.00	YARD	32	LFY65456F		54"	100.00	YARD	16
LFY64850F	8 1/4"	59"	312.00	YARD	49	LFY65461F		54"	104.00	YARD	
LFY64852F	9 1/2"	47"	296.00	YARD	56	LFY65465F		54"	228.00	YARD	
LFY64856F	4 5/8"	59"	620.00	YARD		LFY65554F		54"	100.00	YARD	
LFY64857F	5 3/8"	59"	424.00	YARD	79	LFY65555F		54"	100.00	YARD	
LFY64863F		54"	336.00	YARD	59	LFY65556F		54"	116.00	YARD	
LFY64865F		54"	336.00	YARD	63	LFY65559F		54"	268.00	YARD	
LFY64866F	14 1/4"	55"	336.00	YARD	65	LFY65561F		54"	96.00	YARD	
LFY64874F	32"	54"	560.00	YARD	125	LFY65562F		54"	96.00	YARD	
LFY64877F	27"	54"	336.00	YARD		LFY65564F		54"	96.00	YARD	22
LFY64884F	2"	56"	504.00	YARD	104	LFY65565F		54"	96.00	YARD	
LFY64885F		51"	504.00	YARD	107	LFY65567F		54"	228.00	YARD	53
LFY64886F	24 1/4"	51"	504.00	YARD	129	LFY65568F		54"	120.00	YARD	
LFY64887F	24 1/4"	51"	504.00	YARD	131	LFY65571F		54"	200.00	YARD	
LFY64889F	24 1/4"	51"	504.00	YARD	131	LFY65575F		54"	132.00	YARD	
LFY64895F		59"	320.00	YARD		LFY65576F		54"	104.00	YARD	
LFY64896F		59"	244.00	YARD		LFY65577F		54"	104.00	YARD	23
LFY64921F		54"	424.00	YARD	69	LFY65578F		54"	104.00	YARD	16
LFY64923F		55"	316.00	YARD		LFY65579F		54"	104.00	YARD	
LFY64925F		54"	460.00	YARD	76	LFY65580F		54"	204.00	YARD	
LFY64926F		57"	268.00	YARD		LFY65582F		54"	176.00	YARD	
LFY64928F		59"	268.00	YARD		LFY65635F	10"	54"	236.00	YARD	
LFY64929F		55"	316.00	YARD		LFY65636F		54"	192.00	YARD	40
LFY64930F		55"	304.00	YARD	55	LFY65637F		55"	200.00	YARD	
LFY65097F		55"	312.00	YARD	58	LFY65638F		58"	324.00	YARD	67
LFY65098F		59"	268.00	YARD	50	LFY65639F		54"	304.00	YARD	
LFY65121F	15 3/4"	53"	360.00	YARD	81	LFY65641F		53"	292.00	YARD	53
LFY65123F		54"	304.00	YARD		LFY65643F		56"	324.00	YARD	75
LFY65125F		54"	356.00	YARD	65	LFY65645F		54"	460.00	YARD	
LFY65126F		54"	368.00	YARD		LFY65646F		54"	236.00	YARD	49
LFY65127F		54"	196.00	YARD		LFY65647F		54"	212.00	YARD	44
LFY65130F		55"	176.00	YARD		LFY65648F		56"	188.00	YARD	
LFY65134F	9"	54"	216.00	YARD		LFY65650F	13 1/2"	55"	304.00	YARD	68
LFY65136F	3 1/8"	59"	736.00	YARD		LFY65651F		56"	172.00	YARD	
LFY65140F		58"	300.00	YARD		LFY65652F	18"	53"	344.00	YARD	
LFY65142F		56"	232.00	YARD		LFY65654F		54"	196.00	YARD	37
LFY65143F	14"	68"	368.00	YARD		LFY65659F		56"	188.00	YARD	39
LFY65150F	27"	54"	324.00	YARD		LFY65660F		56"	188.00	YARD	
LFY65151F	25"	53"	368.00	YARD		LFY65661F		54"	260.00	YARD	
LFY65293F	41"	59"	316.00	YARD		LFY65662F		54"	236.00	YARD	
LFY65294F	25"	57"	452.00	YARD	102	LFY65663F		54"	196.00	YARD	37
LFY65295F	27"	57"	452.00	YARD	113	LFY65664F		56"	324.00	YARD	
LFY65296F		57"	248.00	YARD	50	LFY65665F	13 1/2"	55"	304.00	YARD	68
LFY65298F		54"	224.00	YARD		LFY65671F	18"	48"	640.00	YARD	

Prices herein quoted are suggested retail. Prices are subject to change without notice. All shipping and special processing charges are additional.

US Retail Price List - August 2016

Pattern	Repeat	Width	Price	UOM	Grade	Pattern	Repeat	Width	Price	UOM	Grade
LFY65673F	28"	55"	300.00	YARD		LFY66301F		54"	228.00	YARD	51
LFY65676F	28"	55"	312.00	YARD		LFY66302F	47"	54"	212.00	YARD	
LFY65677F		54"	264.00	YARD		LFY66303F	19"	54"	204.00	YARD	45
LFY65678F	18"	53"	360.00	YARD		LFY66304F	19"	54"	204.00	YARD	
LFY65679F		55"	480.00	YARD		LFY66305F	18"	54"	156.00	YARD	
LFY65680F		55"	480.00	YARD		LFY66306F	18"	54"	156.00	YARD	35
LFY65681F	26 3/4"	54"	360.00	YARD		LFY66307F	27"	54"	124.00	YARD	
LFY65685F		54"	112.00	YARD	27	LFY66308F	27"	54"	104.00	YARD	
LFY65690F		55"	204.00	YARD		LFY66309F	27"	54"	124.00	YARD	28
LFY66027F	7 1/4"	59"	324.00	YARD	64	LFY66310F	27"	54"	100.00	YARD	26
LFY66028F		56"	280.00	YARD		LFY66311F		54"	216.00	YARD	37
LFY66029F		56"	280.00	YARD		LFY66312F		54"	284.00	YARD	
LFY66036F		55"	336.00	YARD		LFY66313F	27"	54"	100.00	YARD	23
LFY66038F		55"	336.00	YARD		LFY66314F	25 1/4"	51"	248.00	YARD	64
LFY66039F		55"	528.00	YARD		LFY66348F	27 1/2"	55"	192.00	YARD	
LFY66043F		55"	688.00	YARD		LFY66479F		55"	208.00	YARD	31
LFY66044F		56"	172.00	YARD		LFY66480F		55"	208.00	YARD	31
LFY66046F		56"	172.00	YARD		LFY66483F	38 3/8"	51"	296.00	YARD	69
LFY66047F		56"	188.00	YARD		LFY66484F		55"	276.00	YARD	43
LFY66048F		56"	172.00	YARD		LFY66485F	17"	55"	332.00	YARD	70
LFY66049F		56"	172.00	YARD		LFY66486F		53"	276.00	YARD	58
LFY66050F		54"	344.00	YARD		LFY66487F		55"	200.00	YARD	
LFY66052F		55"	260.00	YARD	47	LFY66488F	27"	57"	452.00	YARD	110
LFY66054F	27"	54"	636.00	YARD	151	LFY66489F	25"	57"	452.00	YARD	102
LFY66055F		54"	220.00	YARD	40	LFY66552F	33"	54"	452.00	YARD	97
LFY66056F	15"	55"	864.00	YARD		LFY66645F	17"	55"	216.00	YARD	34
LFY66058F	27"	54"	200.00	YARD	48	LFY66666F		57"	176.00	YARD	
LFY66062F	18"	52"	360.00	YARD		LFY66667F		57"	176.00	YARD	
LFY66081F	23 7/8"	59"	404.00	YARD	101	LFY66668F		54"	192.00	YARD	30
LFY66082F	19"	59"	408.00	YARD		LFY66669F		54"	192.00	YARD	32
LFY66086F		56"	188.00	YARD		LFY66670F		54"	192.00	YARD	
LFY66087F		56"	188.00	YARD		LFY66671F		54"	232.00	YARD	
LFY66088F		56"	188.00	YARD		LFY66672F		54"	232.00	YARD	
LFY66089F		56"	164.00	YARD		LFY66674F		55"	200.00	YARD	
LFY66090F		56"	172.00	YARD		LFY66675F	32"	56"	160.00	YARD	
LFY66095F		56"	172.00	YARD		LFY66676F	2"	56"	192.00	YARD	
LFY66097F		56"	172.00	YARD		LFY66677F	2"	56"	192.00	YARD	
LFY66098F		56"	172.00	YARD		LFY66678F		55"	320.00	YARD	
LFY66099F		56"	172.00	YARD		LFY66679F	65 7/8"	54"	160.00	YARD	
LFY66100F		56"	172.00	YARD		LFY66680F	66 1/2"	54"	220.00	YARD	
LFY66101F		56"	188.00	YARD		LFY66681F	66 1/2"	54"	220.00	YARD	
LFY66102F		56"	188.00	YARD		LFY66682F		55"	200.00	YARD	
LFY66105F		56"	188.00	YARD		LFY66683F		57"	260.00	YARD	
LFY66106F		56"	188.00	YARD		LFY66684F		57"	260.00	YARD	
LFY66251F		55"	688.00	YARD	125	LFY66685F		57"	260.00	YARD	42
LFY66252F		55"	688.00	YARD	119	LFY66686F	1 3/4"	55"	260.00	YARD	
LFY66278F		54"	124.00	YARD	27	LFY66687F	1 3/4"	55"	260.00	YARD	47
LFY66279F		54"	228.00	YARD	51	LFY66712F		53"	180.00	YARD	
LFY66282F	47"	54"	212.00	YARD	47	LFY66713F	29"	50"	288.00	YARD	
LFY66283F		54"	124.00	YARD	23	LFY66715F	15 1/2"	55"	208.00	YARD	
LFY66284F		59"	244.00	YARD	35	LFY66718F	5 1/4"	52"	180.00	YARD	
LFY66286F		51"	232.00	YARD	40	LFY66719F	9 1/2"	54"	112.00	YARD	
LFY66287F	18"	53"	360.00	YARD	88	LFY66724F	20 1/2"	54"	160.00	YARD	
LFY66290F	18"	53"	360.00	YARD	88	LFY66726F	22"	54"	192.00	YARD	
LFY66291F		55"	188.00	YARD	39	LFY66727F		54"	136.00	YARD	
LFY66292F		56"	172.00	YARD	37	LFY66728F	1/4"	55"	160.00	YARD	
LFY66293F		55"	188.00	YARD	39	LFY66729F	1/4"	55"	160.00	YARD	
LFY66294F		55"	188.00	YARD	39	LFY66731F	1/4"	55"	160.00	YARD	
LFY66295F		56"	172.00	YARD	28	LFY66732F	1/4"	55"	160.00	YARD	
LFY66296F		56"	172.00	YARD		LFY66733F	47 1/2"	1/4"	192.00	YARD	
LFY66298F	21 1/4"	55"	168.00	YARD	34	LFY66734F		54"	160.00	YARD	
LFY66299F		59"	244.00	YARD		LFY66735F	27"	54"	160.00	YARD	
LFY66300F	21 1/4"	55"	168.00	YARD	38	LFY66736F	9 5/8"	52"	124.00	YARD	

Prices herein quoted are suggested retail. Prices are subject to change without notice. All shipping and special processing charges are additional.

US Retail Price List - August 2016

Pattern	Repeat	Width	Price	UOM	Grade	Pattern	Repeat	Width	Price	UOM	Grade		
LFY66737F	22	1 1/2"	54"	160.00	YARD	LFY67184F	22"	54"	276.00	YARD	62		
LFY66881F			55"	480.00	YARD	LFY67188F	3/8"	55"	244.00	YARD	44		
LFY66882F			55"	264.00	YARD	LFY67189F	1 3/4"	55"	296.00	YARD	53		
LFY66885F			55"	320.00	YARD	LFY67190F	1/2"	55"	400.00	YARD			
LFY66886F		33"	55"	280.00	YARD	LFY67191F	1/2"	55"	400.00	YARD			
LFY66887F		8"	59"	456.00	YARD	LFY67192F	3/8"	56"	352.00	YARD			
LFY66888F		8"	59"	240.00	YARD	LFY67193F	3/8"	56"	352.00	YARD			
LFY66889F	7	1 1/2"	59"	240.00	YARD	LFY67194F	1/8"	57"	196.00	YARD			
LFY66890F	6	1 1/4"	54"	320.00	YARD	LFY67195F	1/8"	57"	196.00	YARD	35		
LFY66891F		59"	54"	440.00	YARD	LFY67196F		54"	284.00	YARD			
LFY66892F			54"	160.00	YARD	LFY67197F		54"	284.00	YARD			
LFY66895F		47"	54"	212.00	YARD	LFY67199F		54"	192.00	YARD			
LFY66896F		47"	54"	212.00	YARD	LFY67200F		54"	304.00	YARD	67		
LFY66897F		47"	54"	212.00	YARD	LFY67204F	1/2"	54"	244.00	YARD	40		
LFY66907F			56"	280.00	YARD	LFY67205F		59"	196.00	YARD	36		
LFY66908F			56"	280.00	YARD	LFY67224F		55"	296.00	YARD			
LFY66909F			55"	300.00	YARD	LFY67225F		55"	296.00	YARD			
LFY66910F			55"	300.00	YARD	LFY67226F		54"	236.00	YARD	46		
LFY66911F			55"	300.00	YARD	LFY67227F	1/4"	55"	208.00	YARD			
LFY66912F			55"	440.00	YARD	LFY67228F	1/4"	55"	208.00	YARD	38		
LFY66913F			55"	516.00	YARD	LFY67229F	3/8"	54"	168.00	YARD	29		
LFY66915F			55"	516.00	YARD	LFY67230F	1/4"	56"	364.00	YARD			
LFY66916F			51"	264.00	YARD	LFY67233F		53"	344.00	YARD			
LFY66917F		13"	55"	300.00	YARD	59	LFY67234F		60"	228.00	YARD		
LFY66918F			59"	440.00	YARD		LFY67240F	16	1 1/2"	53"	224.00	YARD	44
LFY66919F			59"	440.00	YARD		LFY67241F		1"	53"	224.00	YARD	38
LFY66920F		14"	55"	320.00	YARD		LFY67244F		4"	56"	236.00	YARD	
LFY66921F			55"	320.00	YARD		LFY67245F		4"	56"	236.00	YARD	42
LFY66947F	29	1 1/2"	54"	160.00	YARD		LFY67246F	25	1/4"	54"	268.00	YARD	
LFY66948F			54"	88.00	YARD	15	LFY67247F	25	1/4"	54"	228.00	YARD	
LFY66950F	14	1 1/2"	55"	180.00	YARD		LFY67248F		55"	348.00	YARD	78	
LFY66951F			54"	160.00	YARD	27	LFY67259F	30	1 1/2"	1 1/2"	344.00	YARD	
LFY66952F	37	1 1/2"	55"	240.00	YARD	52	LFY67260F		54"	204.00	YARD	42	
LFY66953F	3	1 1/2"	54"	140.00	YARD	24	LFY67261F	4	3/4"	1 1/2"	232.00	YARD	43
LFY66954F	7	1 1/4"	59"	160.00	YARD	30	LFY67262F	1	1 1/2"	1 1/2"	232.00	YARD	40
LFY66955F			55"	180.00	YARD	36	LFY67263F		55"	196.00	YARD	39	
LFY66956F		1"	55"	160.00	YARD	27	LFY67264F		54"	196.00	YARD	39	
LFY66957F			55"	160.00	YARD	27	LFY67265F		54"	216.00	YARD	39	
LFY66958F			55"	160.00	YARD	26	LFY67267F		12"	55"	336.00	YARD	58
LFY66959F		18"	54"	160.00	YARD	33	LFY67268F		33"	54"	228.00	YARD	55
LFY66961F		16"	55"	300.00	YARD	61	LFY67270F		1 1/8"	55"	216.00	YARD	44
LFY66962F		1 1/2"	54"	180.00	YARD	36	LFY67271F		55"	212.00	YARD		
LFY66963F	7	1 1/2"	48"	240.00	YARD	45	LFY67272F		55"	212.00	YARD	35	
LFY66964F	14	1 1/2"	55"	180.00	YARD	35	LFY67273F		10"	54"	236.00	YARD	
LFY66965F			55"	140.00	YARD		LFY67274F		38"	55"	248.00	YARD	60
LFY67109F			55"	320.00	YARD		LFY67275F		55"	140.00	YARD		
LFY67111F			55"	216.00	YARD	34	LFY67276F		11"	55"	260.00	YARD	45
LFY67143F			55"	216.00	YARD		LFY67277F		54"	196.00	YARD		
LFY67144F			55"	216.00	YARD		LFY67278F		27"	54"	276.00	YARD	60
LFY67163F			54"	304.00	YARD		LFY67280F		54"	228.00	YARD	41	
LFY67164F			54"	304.00	YARD		LFY67296F		54"	172.00	YARD	29	
LFY67165F			57"	296.00	YARD		LFY67320F	25	1/4"	51"	248.00	YARD	
LFY67166F		13"	55"	300.00	YARD		LFY67321F	25	1/4"	51"	248.00	YARD	
LFY67167F			51"	264.00	YARD		LFY67322F		32"	54"	216.00	YARD	
LFY67168F	17	1 1/2"	52"	396.00	YARD		LFY67323F		32"	54"	216.00	YARD	
LFY67169F			57"	296.00	YARD	53	LFY67347F		58"	124.00	YARD		
LFY67170F		13"	55"	300.00	YARD	58	LFY67359F		58"	124.00	YARD		
LFY67171F		25"	54"	356.00	YARD	84	LIENZO		54"	199.00	YARD	31	
LFY67177F		27"	54"	452.00	YARD	105	LIGHT YEAR		54"	79.00	YARD	10	
LFY67178F	2	1/8"	54"	236.00	YARD		LIGHTSPEED		54"	59.90	YARD	9	
LFY67179F	38	1 1/2"	54"	436.00	YARD		LIMAY	12	1 1/2"	54"	57.90	YARD	19
LFY67180F		1 1/2"	53"	144.00	YARD	24	LIMITLESS	4	1 1/2"	54"	79.00	YARD	10
LFY67183F		22"	54"	276.00	YARD	56	LIMPOPO		27"	54"	99.80	YARD	17

Prices herein quoted are suggested retail. Prices are subject to change without notice. All shipping and special processing charges are additional.

US Retail Price List - August 2016

Pattern	Repeat	Width	Price	UOM	Grade	Pattern	Repeat	Width	Price	UOM	Grade
LIPIZZAN		54"	59.80	YARD	12	LWP17541W		36"	184.00	ROLL	
LIS	27 1/2"	51"	150.00	YARD		LWP17542W		36"	216.00	ROLL	
LISENA/D	27"	55"	79.00	YARD	5	LWP17543W		36"	186.00	ROLL	
LITESTAR		54"	139.00	YARD	21	LWP22317W		36"	232.00	ROLL	
LITTLE DOT	7"	54"	37.00	YARD	11	LWP22320W	6"	36"	260.00	ROLL	
LIVE AS ONE	6 1/2"	1 1/2"	298.00	YARD	40	LWP22322W		36"	186.00	ROLL	
LLF64189F	36"	54"	52.00	YARD	13	LWP22324W		36"	192.00	ROLL	
LLF64192F	5 1/2"	56"	52.00	YARD	10	LWP22327W		28"	200.00	ROLL	
LLF64194F	18"	54"	52.00	YARD	11	LWP22328W		36"	192.00	ROLL	
LLF64197F	16"	54"	52.00	YARD	13	LWP22329W		36"	192.00	ROLL	
LLF64198F	16"	54"	48.00	YARD	11	LWP22330W		36"	192.00	ROLL	
LLF64221F	10 1/2"	55"	52.00	YARD	11	LWP22332W		36"	216.00	ROLL	
LLF64224F		55"	52.00	YARD	15	LWP22333W		36"	216.00	ROLL	
LLF64226F	27 1/2"	55"	52.00	YARD	13	LWP22339W		27"	134.00	ROLL	
LLF64552F		55"	52.00	YARD		LWP22370W		27"	110.00	ROLL	
LLF64560F		55"	52.00	YARD	10	LWP30570W	25 1/4"	27"	174.00	ROLL	
LLF64571F	14 1/2"	55"	52.00	YARD	11	LWP30571W	25 1/4"	27"	174.00	ROLL	
LLF64575F	15"	55"	52.00	YARD		LWP30572W	25 1/4"	27"	174.00	ROLL	
LLF64576F	15"	55"	56.00	YARD	11	LWP30592W	25 1/4"	27"	124.00	ROLL	
LLF64586F		60"	60.00	YARD	11	LWP30599W		27"	120.00	ROLL	
LLF64587F		55"	52.00	YARD	9	LWP30601W		27"	120.00	ROLL	
LLF64588F	14"	60"	52.00	YARD		LWP30602W		27"	120.00	ROLL	
LLF64591F		60"	60.00	YARD	11	LWP30607W		27"	120.00	ROLL	
LLF64595F		54"	64.00	YARD	11	LWP30619W	20 1/2"	20"	116.00	ROLL	
LLF64596F	14"	60"	52.00	YARD		LWP30621W	20 1/2"	20"	116.00	ROLL	
LLF64597F		54"	60.00	YARD	14	LWP30645W	25 1/4"	27"	116.00	ROLL	
LLF64601F	36"	54"	48.00	YARD	13	LWP40830W		36"	224.00	ROLL	
LLF64608F	25 1/4"	54"	52.00	YARD	12	LWP40833W	22 1/2"	36"	64.00	YARD	
LLF64609F	25 1/4"	54"	52.00	YARD		LWP40834W		36"	404.00	ROLL	
LLF64615F		54"	56.00	YARD		LWP40835W		36"	216.00	ROLL	
LLF64939F	18"	54"	92.00	YARD	18	LWP40839W		36"	282.00	ROLL	
LLF64940F	18"	54"	92.00	YARD		LWP40842W	24"	36"	92.00	YARD	
LLF64945F		56"	80.00	YARD	13	LWP40843W		36"	272.00	ROLL	
LLF64947F	7 1/4"	54"	96.00	YARD	16	LWP40844W		36"	192.00	ROLL	
LLF64960F	8 1/2"	56"	96.00	YARD	17	LWP40852W		36"	372.00	ROLL	
LLF65343F	18"	54"	120.00	YARD		LWP40856W		36"	422.00	ROLL	
LLF65345F	16"	54"	84.00	YARD	17	LWP40862W		36"	260.00	ROLL	
LLF65351F	32"	54"	104.00	YARD		LWP40864W		36"	260.00	ROLL	
LLF65352F	27"	54"	84.00	YARD	18	LWP40865W	27"	27"	376.00	ROLL	
LLF65353F	3 1/2"	54"	108.00	YARD	19	LWP40872W		36"	216.00	ROLL	
LLF65354F	36"	54"	108.00	YARD	31	LWP40873W		36"	192.00	ROLL	
LLF65355F	36"	54"	108.00	YARD		LWP40879W	24 3/4"	36"	98.00	YARD	
LLF65363F	10"	54"	104.00	YARD	19	LWP40880W	24 3/4"	36"	102.00	YARD	
LLF65364F	10"	54"	104.00	YARD		LWP40881W	24 3/4"	36"	102.00	YARD	
LLF65365F	10"	54"	104.00	YARD		LWP40882W	24 3/4"	36"	98.00	YARD	
LLF65366F	10"	54"	104.00	YARD		LWP40883W	24 3/4"	36"	98.00	YARD	
LLF65369F		54"	104.00	YARD		LWP50890W	27"	20"	84.00	ROLL	
LLF65378F		54"	72.00	YARD	12	LWP50891W	27"	20"	84.00	ROLL	
LLF65453F		54"	104.00	YARD		LWP50893W	20 1/2"	20"	80.00	ROLL	
LOCKPORT		54"	51.50	YARD	12	LWP50900W	27"	27"	524.00	ROLL	
LOOKER		54"	59.90	YARD	9	LWP50927W	27"	20"	84.00	ROLL	
LORIS		54"	79.80	YARD	10	LWP50931W	27"	20"	84.00	ROLL	
LORTON	36" 1/2"		79.00	YARD	17	LWP50942W	25 1/4"	27"	92.00	ROLL	
LOTA	25"	54"	47.90	YARD	13	LWP50950W	20 1/2"	20"	84.00	ROLL	
LOWE		54"	79.00	YARD	11	LWP50952W	20 1/2"	20"	84.00	ROLL	
LUCETTE	25"	54"	69.00	YARD	14	LWP50955W	20 1/2"	20"	84.00	ROLL	
LUMIERE		59"	198.00	YARD		LWP60701W		36"	146.00	ROLL	
LUX LIZARD		54"	298.00	YARD	38	LWP60702W		36"	178.00	ROLL	
LUZERNE	27"	54"	63.90	YARD	20	LWP60703W		36"	192.00	ROLL	
LWP16316W		36"	260.00	ROLL		LWP60704W		36"	192.00	ROLL	
LWP16330W		36"	260.00	ROLL		LWP60706W	25 1/4"	20"	186.00	ROLL	
LWP16331W		36"	260.00	ROLL		LWP60708W	3"	20"	92.00	ROLL	
LWP17540W		36"	196.00	ROLL		LWP60709W	3"	20"	92.00	ROLL	

Prices herein quoted are suggested retail. Prices are subject to change without notice. All shipping and special processing charges are additional.

US Retail Price List - August 2016

Pattern	Repeat	Width	Price	UOM	Grade	Pattern	Repeat	Width	Price	UOM	Grade
LWP60710W	25	1/4"	27"	114.00	ROLL	LWP62741W		36"	192.00	ROLL	
LWP60715W	25	1/4"	27"	102.00	ROLL	LWP62743W	6	1/4"	36"	104.00	YARD
LWP60716W	25	1/4"	27"	102.00	ROLL	LWP62745W	6	1/4"	36"	104.00	YARD
LWP60727W	10	1/4"	20"	114.00	ROLL	LWP62749W			164.00	YARD	
LWP60730W	25	1/4"	27"	100.00	ROLL	LWP62750W		57"	120.00	YARD	
LWP60734W		20"	20"	114.00	ROLL	LWP62751W		54"	136.00	YARD	
LWP60738W	13	1/2"	27"	102.00	ROLL	LWP62752W	3"	59"	202.00	YARD	
LWP60740W	25	1/4"	27"	174.00	ROLL	LWP62753W	1"	54"	254.00	YARD	
LWP60750W		20"	92.00	ROLL	LWP62754W		59"	276.00	YARD		
LWP60751W		27"	120.00	ROLL	LWP64357W	25	1/4"	27"	174.00	ROLL	
LWP60752W	13"	27"	140.00	ROLL	LWP64358W	25	1/4"		174.00	ROLL	
LWP60753W		20"	86.00	ROLL	LWP64359W		27"	100.00	ROLL		
LWP60757W		27"	100.00	ROLL	LWP64360W		27"	88.00	ROLL		
LWP60760W		20"	82.00	ROLL	LWP64361W		27"	100.00	ROLL		
LWP60805W		45"	338.00	YARD	LWP64363W		20"	172.00	ROLL		
LWP62165W	18"	27"	88.00	ROLL	LWP64364W		20"	172.00	ROLL		
LWP62166W	18"	27"	88.00	ROLL	LWP64366W		18"	20"	92.00	ROLL	
LWP62167W	27"	27"	88.00	ROLL	LWP64367W		18"	20"	92.00	ROLL	
LWP62172W		27"	100.00	ROLL	LWP64368W	20	1/2"	20"	84.00	ROLL	
LWP62173W		27"	100.00	ROLL	LWP64369W	13	1/2"	34"	372.00	ROLL	
LWP62177W		27"	100.00	ROLL	LWP64370W	13	1/2"	34"	372.00	ROLL	
LWP62180W		27"	27"	88.00	ROLL	LWP64374W		36"	140.00	ROLL	
LWP62185W		27"	27"	120.00	ROLL	LWP64375W		36"	134.00	ROLL	
LWP62186W		27"	27"	120.00	ROLL	LWP64376W		36"	404.00	ROLL	
LWP62187W	2	1/2"	27"	100.00	ROLL	LWP64377W		36"	422.00	ROLL	
LWP62188W	2	1/2"	27"	100.00	ROLL	LWP64378W		36"	422.00	ROLL	
LWP62192W		27"	27"	100.00	ROLL	LWP64379W	22	1/2"	64.00	YARD	
LWP62200W	20	1/2"	20"	100.00	ROLL	LWP64380W	22	1/2"	60.00	YARD	
LWP62202W		27"	96.00	ROLL	LWP64381W	22	1/2"	64.00	YARD		
LWP62203W		27"	100.00	ROLL	LWP64382W	22	1/2"	64.00	YARD		
LWP62212W		24"	20"	100.00	ROLL	LWP64383W		36"	192.00	ROLL	
LWP62214W	25	1/4"	27"	100.00	ROLL	LWP64384W		36"	192.00	ROLL	
LWP62215W	25	1/4"	27"	100.00	ROLL	LWP64385W		36"	192.00	ROLL	
LWP62218W		18"	27"	100.00	ROLL	LWP64386W	25	1/4"	36"	204.00	ROLL
LWP62220W		21"	27"	100.00	ROLL	LWP64387W	25	1/4"	27"	204.00	ROLL
LWP62221W		21"	27"	100.00	ROLL	LWP64388W			150.00	YARD	
LWP62222W	13	1/2"	27"	100.00	ROLL	LWP64389W			156.00	YARD	
LWP62223W		27"	27"	100.00	ROLL	LWP64390W			156.00	YARD	
LWP62224W		27"	27"	100.00	ROLL	LWP64391W		36"	218.00	ROLL	
LWP62226W		27"	27"	100.00	ROLL	LWP64392W		36"	218.00	ROLL	
LWP62227W		27"	27"	100.00	ROLL	LWP64393W		36"	238.00	ROLL	
LWP62228W		1"	36"	234.00	ROLL	LWP64395W		36"	204.00	ROLL	
LWP62229W			36"	178.00	ROLL	LWP64396W		36"	196.00	ROLL	
LWP62711W	10	1/4"	1/2"	84.00	ROLL	LWP64397W		36"	204.00	ROLL	
LWP62712W			1/2"	74.00	ROLL	LWP64398W	27"	27"	376.00	ROLL	
LWP62713W			1/2"	74.00	ROLL	LWP64399W	24"		288.00	YARD	
LWP62714W	1	3/4"	1/2"	56.00	ROLL	LWP64402W		36"	238.00	ROLL	
LWP62715W	1	3/4"	1/2"	56.00	ROLL	LWP64403W		36"	216.00	ROLL	
LWP62716W	1	3/4"	1/2"	56.00	ROLL	LWP64404W		36"	216.00	ROLL	
LWP62717W			1/2"	58.00	ROLL	LWP64971W		36"	192.00	ROLL	
LWP62719W		4"	1/2"	66.00	ROLL	LWP64973W		36"	192.00	ROLL	
LWP62720W		4"	1/2"	66.00	ROLL	LWP64974W		36"	192.00	ROLL	
LWP62721W		4"	1/2"	66.00	ROLL	LWP64977W		36"	232.00	ROLL	
LWP62722W			1/2"	56.00	ROLL	LWP64995W	5	1/2"	45"	350.00	YARD
LWP62723W			1/2"	56.00	ROLL	LWP64996W	5	1/2"	45"	350.00	YARD
LWP62725W			1/2"	56.00	ROLL	LWP64998W		45"	394.00	YARD	
LWP62727W			1/2"	56.00	ROLL	LWP65002W	20"	36"	316.00	YARD	
LWP62729W			1/2"	56.00	ROLL	LWP65005W	30"	27"	80.00	ROLL	
LWP62730W			1/2"	56.00	ROLL	LWP65006W	30"	27"	80.00	ROLL	
LWP62732W		36"	224.00	ROLL	LWP65008W	30"	27"	80.00	ROLL		
LWP62735W		36"	182.00	ROLL	LWP65009W	10	1/4"	27"	80.00	ROLL	
LWP62737W		36"	184.00	ROLL	LWP65011W	10	1/4"	27"	80.00	ROLL	
LWP62739W		36"	404.00	ROLL	LWP65012W	27"	27"	80.00	ROLL		

Prices herein quoted are suggested retail. Prices are subject to change without notice. All shipping and special processing charges are additional.

US Retail Price List - August 2016

Pattern	Repeat	Width	Price	UOM	Grade	Pattern	Repeat	Width	Price	UOM	Grade
LWP65013W	27"	27"	80.00	ROLL		LWP65712W	24"	20"	84.00	ROLL	
LWP65017W		27"	76.00	ROLL		LWP65713W	24"	20"	84.00	ROLL	
LWP65019W		27"	80.00	ROLL		LWP65714W	24"	20"	84.00	ROLL	
LWP65020W	30"	27"	80.00	ROLL		LWP65715W		27"	120.00	ROLL	
LWP65021W		51"	228.00	YARD		LWP65716W		27"	120.00	ROLL	
LWP65022W	30"	27"	80.00	ROLL		LWP65717W		27"	120.00	ROLL	
LWP65024W	30"	27"	80.00	ROLL		LWP65719W		20"	86.00	ROLL	
LWP65026W		36"	322.00	ROLL		LWP65720W		20"	74.00	ROLL	
LWP65027W		36"	272.00	ROLL		LWP65721W		20"	74.00	ROLL	
LWP65176W	20 1/2"	1/2"	84.00	ROLL		LWP65722W		27"	88.00	ROLL	
LWP65177W	20 1/2"	1/2"	116.00	ROLL		LWP65726W		20"	74.00	ROLL	
LWP65352W		36"	192.00	ROLL		LWP65727W	4 1/8"	20"	66.00	ROLL	
LWP65353W		36"	422.00	ROLL		LWP65729W	3"	20"	92.00	ROLL	
LWP65361W		36"	178.00	ROLL		LWP65730W	3"	20"	92.00	ROLL	
LWP65363W		36"	192.00	ROLL		LWP65731W	3"	20"	92.00	ROLL	
LWP65367W		36"	192.00	ROLL		LWP65732W	10 1/4"	20"	84.00	ROLL	
LWP65369W		36"	192.00	ROLL		LWP65733W	10 1/4"	20"	84.00	ROLL	
LWP65371W		36"	192.00	ROLL		LWP65736W	25 1/4"	27"	102.00	ROLL	
LWP65373W		36"	192.00	ROLL		LWP65737W	25 1/4"	27"	124.00	ROLL	
LWP65374W		36"	192.00	ROLL		LWP65738W	25 1/4"	27"	124.00	ROLL	
LWP65376W	3 1/4"	36"	192.00	ROLL		LWP65740W	25 1/4"	27"	124.00	ROLL	
LWP65378W		52"	192.00	YARD		LWP65743W	20 1/2"	20"	84.00	ROLL	
LWP65379W		52"	192.00	YARD		LWP65744W	25 1/4"	27"	174.00	ROLL	
LWP65380W		36"	192.00	ROLL		LWP66191W		20"	58.00	ROLL	
LWP65381W		36"	184.00	ROLL		LWP66192W		20"	58.00	ROLL	
LWP65382W		36"	192.00	ROLL		LWP66193W		20"	58.00	ROLL	
LWP65383W		36"	192.00	ROLL		LWP66194W		20"	58.00	ROLL	
LWP65385W		36"	184.00	YARD		LWP66195W	28 1/4"	27"	58.00	ROLL	
LWP65386W		36"	184.00	YARD		LWP66196W	28 1/4"	27"	58.00	ROLL	
LWP65389W	5/8"	36"	184.00	YARD		LWP66197W	28 1/4"	27"	58.00	ROLL	
LWP65390W	5/8"	36"	184.00	YARD		LWP66198W		20"	58.00	ROLL	
LWP65391W	5/8"	36"	184.00	YARD		LWP66199W		20"	58.00	ROLL	
LWP65392W	5/8"	36"	192.00	YARD		LWP66200W		20"	58.00	ROLL	
LWP65394W	25 1/4"	27"	174.00	ROLL		LWP66201W		20"	58.00	ROLL	
LWP65395W	25 1/4"	27"	174.00	ROLL		LWP66202W		20"	58.00	ROLL	
LWP65396W	25 1/4"	27"	174.00	ROLL		LWP66203W		20"	58.00	ROLL	
LWP65397W	25 1/4"	27"	174.00	ROLL		LWP66204W		20"	58.00	ROLL	
LWP65398W		1/2"	172.00	ROLL		LWP66205W		20"	58.00	ROLL	
LWP65399W	27 1/2"	1/2"	188.00	ROLL		LWP66206W		20"	58.00	ROLL	
LWP65400W	27 1/2"	1/2"	188.00	ROLL		LWP66207W		20"	58.00	ROLL	
LWP65401W	27"	27"	148.00	ROLL		LWP66208W		20"	58.00	ROLL	
LWP65402W	27"	27"	148.00	ROLL		LWP66209W		20"	58.00	ROLL	
LWP65404W	27"	27"	148.00	ROLL		LWP66210W		20"	58.00	ROLL	
LWP65405W	25 1/4"	27"	148.00	ROLL		LWP66211W		20"	58.00	ROLL	
LWP65406W	25 1/4"	27"	148.00	ROLL		LWP66212W		20"	58.00	ROLL	
LWP65407W	25 1/4"	27"	142.00	ROLL		LWP66213W		20"	58.00	ROLL	
LWP65408W	25 1/4"	1/2"	148.00	ROLL		LWP66214W		20"	58.00	ROLL	
LWP65409W	25 1/4"	1/2"	148.00	ROLL		LWP66215W		20"	70.00	ROLL	
LWP65411W	25 1/4"	1/2"	148.00	ROLL		LWP66216W		20"	70.00	ROLL	
LWP65412W	27 1/2"	1/2"	188.00	ROLL		LWP66217W		20"	70.00	ROLL	
LWP65413W	5 1/4"	1/2"	102.00	ROLL		LWP66218W		20"	70.00	ROLL	
LWP65414W	5 1/4"	1/2"	102.00	ROLL		LWP66219W		27"	58.00	ROLL	
LWP65416W	18"	1/2"	102.00	ROLL		LWP66220W		27"	58.00	ROLL	
LWP65419W	29 7/8"	1/2"	188.00	ROLL		LWP66221W		27"	58.00	ROLL	
LWP65421W	29 7/8"	1/2"	188.00	ROLL		LWP66222W		27"	58.00	ROLL	
LWP65422W		27"	88.00	ROLL		LWP66223W		20"	172.00	ROLL	
LWP65423W		27"	88.00	ROLL		LWP66224W		20"	172.00	ROLL	
LWP65425W		27"	88.00	ROLL		LWP66225W		20"	172.00	ROLL	
LWP65426W	3 1/2"	36"	192.00	ROLL		LWP66226W		20"	172.00	ROLL	
LWP65493W	5/8"	36"	184.00	YARD		LWP66227W	9"	27"	102.00	ROLL	
LWP65707W	27"	20"	84.00	ROLL		LWP66228W	9"	27"	102.00	ROLL	
LWP65709W	27"	20"	84.00	ROLL		LWP66229W	9"	27"	102.00	ROLL	
LWP65710W	20 1/2"	20"	84.00	ROLL		LWP66230W		54"	130.00	YARD	

Prices herein quoted are suggested retail. Prices are subject to change without notice. All shipping and special processing charges are additional.

US Retail Price List - August 2016

Pattern	Repeat	Width	Price	UOM	Grade	Pattern	Repeat	Width	Price	UOM	Grade
LWP66231W		54"	136.00	YARD		LWP67037W		36"	244.00	ROLL	
LWP66232W		54"	136.00	YARD		LWP67038W			176.00	YARD	
LWP66233W		54"	136.00	YARD		LWP67039W			176.00	YARD	
LWP66237W		36"	178.00	ROLL		LWP67040W			176.00	YARD	
LWP66238W		36"	242.00	ROLL		LWP67041W			176.00	YARD	
LWP66239W		36"	242.00	ROLL		LWP67042W	20	1/2" 1/2"	156.00	ROLL	
LWP66240W		36"	242.00	ROLL		LWP67044W		36"	192.00	ROLL	
LWP66241W		36"	242.00	ROLL		LWP67045W	25	1/4" 27"	142.00	ROLL	
LWP66242W		36"	214.00	ROLL		LWP67049W			56.00	YARD	
LWP66243W		36"	214.00	ROLL		LWP67050W			56.00	YARD	
LWP66244W		36"	214.00	ROLL		LWP67054W	25"	27"	96.00	ROLL	
LWP66245W		36"	214.00	ROLL		LWP67432W		36"	120.00	YARD	
LWP66247W		36"	192.00	ROLL		LWP67434W	1	1/4" 57"	220.00	YARD	
LWP66248W		36"	192.00	ROLL		LWP67438W		25" 27"	136.00	ROLL	
LWP66349W		20"	58.00	ROLL		LWP67439W		25" 27"	136.00	ROLL	
LWP66351W		36"	242.00	ROLL		LWP67440W		25" 27"	136.00	ROLL	
LWP66515W		27"	174.00	ROLL		LWP67441W		36" 27"	124.00	ROLL	
LWP66516W		27"	174.00	ROLL		LWP67442W		36" 27"	124.00	ROLL	
LWP66517W		27"	174.00	ROLL		LWP67443W		18" 36"	56.00	YARD	
LWP66979W	25"	27"	96.00	ROLL		LWP67444W		18" 36"	56.00	YARD	
LWP66980W	25"	27"	96.00	ROLL		LWP67445W		18" 36"	56.00	YARD	
LWP66981W	25"	27"	96.00	ROLL		LWP67446W		18" 36"	56.00	YARD	
LWP66982W	20"	27"	72.00	ROLL		LWP67447W	11	1/8" 36"	310.00	YARD	
LWP66983W	20"	27"	72.00	ROLL		LWP67449W			54" 96.00	YARD	
LWP66984W	20"	27"	72.00	ROLL		LWP67450W		25" 27"	136.00	ROLL	
LWP66985W	25"	27"	96.00	ROLL		LWP67451W			54" 96.00	YARD	
LWP66986W	25"	27"	96.00	ROLL		LWP67452W		7" 54"	148.00	YARD	
LWP66987W	25"	27"	96.00	ROLL		LWP67453W		7" 54"	148.00	YARD	
LWP66988W	20	1/2" 1/2"	68.00	ROLL		LWP67454W		7" 54"	148.00	YARD	
LWP66989W	20	1/2" 1/2"	68.00	ROLL		LWP67455W	47	1/4" 59"	284.00	YARD	
LWP66991W		1/2"	64.00	ROLL		LWP67456W	47	1/4" 59"	284.00	YARD	
LWP66994W	3/8"	1/2"	194.00	ROLL		LWP67457W	47	1/4" 59"	284.00	YARD	
LWP66995W	3/8"	1/2"	194.00	ROLL		LWP67458W	47	1/4" 59"	284.00	YARD	
LWP66996W	3/8"	1/2"	194.00	ROLL		LWP67459W		25" 27"	136.00	ROLL	
LWP66997W		9" 1/2"	192.00	ROLL		LWP67460W		36"	192.00	ROLL	
LWP66998W		9" 1/2"	192.00	ROLL		LWP67461W		36"	192.00	ROLL	
LWP66999W		9" 1/2"	192.00	ROLL		LWP67462W		36"	238.00	ROLL	
LWP67000W		15" 1/2"	156.00	ROLL		LWP67463W		36"	192.00	ROLL	
LWP67002W		15" 1/2"	156.00	ROLL		LWP67464W		36"	192.00	ROLL	
LWP67003W	20	1/2" 1/2"	156.00	ROLL		LWP67465W		36"	192.00	ROLL	
LWP67004W	20	1/2" 1/2"	156.00	ROLL		LWP67466W		36"	192.00	ROLL	
LWP67005W	20	1/2" 1/2"	156.00	ROLL		LWP67467W		36"	148.00	YARD	
LWP67006W		7" 1/2"	178.00	ROLL		LWP67468W		36"	148.00	YARD	
LWP67007W		7" 1/2"	178.00	ROLL		LWP67469W		36"	232.00	ROLL	
LWP67008W		7" 1/2"	178.00	ROLL		LWP67470W		36"	232.00	ROLL	
LWP67012W			188.00	YARD		LWP67471W		36"	232.00	ROLL	
LWP67013W			188.00	YARD		LWP67472W		36"	232.00	ROLL	
LWP67014W			188.00	YARD		LWP67473W		36"	224.00	ROLL	
LWP67015W			98.00	YARD		LWP67474W	20	3/4" 36"	364.00	ROLL	
LWP67019W			130.00	YARD		LWP67475W		46"	316.00	YARD	
LWP67023W			150.00	YARD		LWP67476W		46"	316.00	YARD	
LWP67024W			150.00	YARD		LWP67477W		52"	276.00	YARD	
LWP67026W		36"	224.00	ROLL		LWP67478W		54"	284.00	YARD	
LWP67027W	3/8"	1/2"	194.00	ROLL		LWP67479W		52"	388.00	YARD	
LWP67028W		36"	224.00	ROLL		LWP67480W		36"	284.00	ROLL	
LWP67029W			358.00	YARD		LWP67482W		25" 27"	136.00	ROLL	
LWP67030W			358.00	YARD		LWP67575W		36" 27"	124.00	ROLL	
LWP67031W	9"	1/2"	192.00	ROLL		LWP67581W	11	1/8" 36"	310.00	YARD	
LWP67032W		36"	208.00	ROLL		LYRE		122"	248.00	YARD	
LWP67033W		36"	208.00	ROLL		LZ-30002	3	1/2" 54"	41.90	YARD	10
LWP67034W		36"	208.00	ROLL		LZ-30003		32" 55"	298.00	YARD	
LWP67035W		36"	244.00	ROLL		LZ-30004	27	1/2" 55"	256.00	YARD	
LWP67036W		36"	244.00	ROLL			17	1/2" 1/2"	490.00	YARD	

Prices herein quoted are suggested retail. Prices are subject to change without notice. All shipping and special processing charges are additional.

US Retail Price List - August 2016

Pattern	Repeat	Width	Price	UOM	Grade	Pattern	Repeat	Width	Price	UOM	Grade		
LZ-30006	23	1/2"	54"	298.00	YARD	LZ-30109		55"	196.00	YARD	19		
LZ-30007	23	1/2"	54"	298.00	YARD	LZ-30110		55"	248.00	YARD	34		
LZ-30009		1/2"	190.00	YARD		LZ-30111		55"	196.00	YARD	19		
LZ-30010		118"	170.00	YARD		LZ-30112		65"	55"	198.00	YARD		
LZ-30011	25	1/2"	52"	330.00	YARD	LZ-30114	23	1/2"	54"	316.00	YARD		
LZ-30015		1/2"	256.00	YARD		LZ-30115		67"	55"	430.00	YARD		
LZ-30017		55"	198.00	YARD	33	LZ-30116	39	1/2"	57"	398.00	YARD		
LZ-30018		55"	298.00	YARD		LZ-30117		122"	456.00	YARD			
LZ-30020	43	1/2"	1/2"	296.00	YARD	LZ-30118		25"	1/2"	450.00	YARD		
LZ-30023		1/2"	248.00	YARD		LZ-30120	2	1/2"	1/2"	336.00	YARD		
LZ-30026	20	1/2"	57"	296.00	YARD	LZ-30121		122"	268.00	YARD			
LZ-30028		55"	250.00	YARD	36	LZ-30124		120"	298.00	YARD			
LZ-30030		56"	248.00	YARD		LZ-30126		54"	348.00	YARD	34		
LZ-30031	82	1/2"	1/2"	250.00	YARD	LZ-30127		116"	170.00	YARD			
LZ-30032	15	1/2"	118"	250.00	YARD	LZ-30128		122"	248.00	YARD			
LZ-30033		122"	296.00	YARD		LZ-30129	33"	118"	348.00	YARD			
LZ-30034		117"	270.00	YARD		LZ-30130		122"	296.00	YARD			
LZ-30035		122"	296.00	YARD		LZ-30131		31"	122"	196.00	YARD		
LZ-30036		116"	296.00	YARD		LZ-30132	1	1/2"	114"	298.00	YARD		
LZ-30037		123"	98.00	YARD		LZ-30133		113"	136.00	YARD			
LZ-30039		118"	298.00	YARD		LZ-30134		118"	98.00	YARD			
LZ-30041		118"	250.00	YARD		LZ-30135		124"	176.00	YARD			
LZ-30042	16	1/2"	1/2"	370.00	YARD	LZ-30136		126"	136.00	YARD			
LZ-30043		116"	118.00	YARD		LZ-30137		122"	376.00	YARD			
LZ-30046	7	1/2"	118"	290.00	YARD	LZ-30138		37"	121"	276.00	YARD		
LZ-30053		54"	199.00	YARD	31	LZ-30139		118"	176.00	YARD			
LZ-30054	27	1/2"	51"	150.00	YARD	LZ-30140		122"	248.00	YARD			
LZ-30055	27	1/2"	106"	320.00	YARD	LZ-30141		29"	122"	348.00	YARD		
LZ-30058		1/2"	98.00	YARD		LZ-30142	73	1/2"	55"	176.00	YARD		
LZ-30060		55"	296.00	YARD	39	LZ-30143		55"	198.00	YARD			
LZ-30061	13	1/2"	52"	298.00	YARD	LZ-30144		55"	248.00	YARD			
LZ-30065		53"	250.00	YARD		LZ-30145		55"	176.00	YARD	36		
LZ-30066		4"	54"	298.00	YARD	LZ-30146		53"	198.00	YARD			
LZ-30067		36"	54"	270.00	YARD	40	LZ-30147		56"	296.00	YARD	86	
LZ-30068	27	1/2"	55"	350.00	YARD	61	LZ-30148		55"	198.00	YARD		
LZ-30070		25"	54"	350.00	YARD	55	LZ-30149		55"	198.00	YARD		
LZ-30071		52"	53"	350.00	YARD		LZ-30150		55"	198.00	YARD	55	
LZ-30077		53"	236.00	YARD		LZ-30151		70"	55"	276.00	YARD		
LZ-30079	39	1/2"	55"	298.00	YARD	LZ-30152		28"	54"	398.00	YARD		
LZ-30080	27	1/2"	59"	196.00	YARD	LZ-30153		55"	168.00	YARD			
LZ-30081		1/2"	470.00	YARD		LZ-30154		55"	178.00	YARD			
LZ-30083	23	1/2"	121"	350.00	YARD	LZ-30155	17	1/2"	53"	490.00	YARD		
LZ-30084	14	1/2"	117"	248.00	YARD	LZ-30156		53"	55"	248.00	YARD		
LZ-30085		1/2"	350.00	YARD		LZ-30157		15"	51"	398.00	YARD		
LZ-30086		21"	1/2"	350.00	YARD	LZ-30158		59"	198.00	YARD			
LZ-30087		118"	248.00	YARD		LZ-30159		55"	198.00	YARD			
LZ-30088		120"	248.00	YARD		LZ-30160		20"	1/2"	398.00	YARD		
LZ-30089	9	1/2"	120"	230.00	YARD	LZ-30161		8"	54"	198.00	YARD		
LZ-30090		120"	230.00	YARD		LZ-30162		18"	55"	398.00	YARD		
LZ-30091		116"	230.00	YARD		LZ-30163		26"	55"	276.00	YARD		
LZ-30092		120"	230.00	YARD		MACAFEE	17	1/2"	54"	68.90	YARD	18	
LZ-30093		54"	270.00	YARD		MACAROONS		25"	63"	55.00	YARD	15	
LZ-30095		119"	236.00	YARD		MADIRA	12	1/2"	54"	79.80	YARD	14	
LZ-30096		119"	148.00	YARD		MADISON SQ		54"	59.90	YARD	9		
LZ-30098		1/2"	276.00	YARD		MADRONA		27"	54"	59.90	YARD	23	
LZ-30100		1/2"	256.00	YARD		MAGNOLIA	27	1/2"	106"	320.00	YARD		
LZ-30101		46"	55"	650.00	YARD	MAHARASTRA	14	1/2"	54"	76.90	YARD	21	
LZ-30102		35"	55"	390.00	YARD	56	MAKRIS		9"	54"	17.00	YARD	
LZ-30103		53"	56"	436.00	YARD		MALU IKAT	23"	53"	149.00	YARD	28	
LZ-30104	4	1/2"	51"	170.00	YARD	28	MAMUSHI		54"	59.90	YARD	7	
LZ-30105	17	1/2"	59"	256.00	YARD	37	MANADO		18"	54"	39.90	YARD	23
LZ-30106		54"	148.00	YARD	28	MANASA		9"	54"	63.90	YARD	14	
LZ-30108		55"	230.00	YARD	26	MANCHUIRIA		67"	55"	430.00	YARD		

Prices herein quoted are suggested retail. Prices are subject to change without notice. All shipping and special processing charges are additional.

US Retail Price List - August 2016

Pattern	Repeat	Width	Price	UOM	Grade	Pattern	Repeat	Width	Price	UOM	Grade
MANCHURIA	67"	55"	430.00	YARD		MYANMAR	25"	55"	298.00	YARD	58
MANDRYKA	27"	54"	57.90	YARD	22	MYKONOS	118"		170.00	YARD	
MANKOLAM	13 1/2"	54"	63.90	YARD	22	MYLO	7"	54"	76.90	YARD	14
MANNAR	25 1/4"	54"	79.90	YARD	22	NAHUEL	25"	54"	71.90	YARD	26
MANTA		54"	59.90	YARD	9	NAJA		54"	59.90	YARD	9
MAPLE		123"	98.00	YARD		NALGONDA	4 1/2"	54"	55.90	YARD	13
MAR SWIRL	36"	54"	119.00	YARD	24	NAMAQUA	9 1/2"	54"	79.80	YARD	11
MARAKECH		118"	148.00	YARD		NAPA		54"	59.90	YARD	9
MARBLEIZED		54"	145.00	YARD	22	NARI		54"	59.90	YARD	9
MARBLEWORK	23"	54"	97.00	YARD	20	NASHIK	25 1/2"	52"	149.00	YARD	32
MARCO POLO	36"	54"	199.00	YARD	36	NASIK	36"	54"	62.90	YARD	23
MARE		54"	139.90	YARD	15	NAVAJO	27 1/2"	59"	196.00	YARD	
MARIANGELA	18"	54"	46.90	YARD	12	NAVI		54"	59.90	YARD	6
MARISSA/D	18"	54"	35.00	YARD	5	NAXOS		119"	236.00	YARD	
MARTINELLI	18"	54"	44.90	YARD	16	NEBBIA		54"	148.90	YARD	22
MARTINIQUE	31"	122"	196.00	YARD		NEELIX		54"	85.80	YARD	11
MARVA		54"	59.80	YARD	11	NEVE		54"	177.90	YARD	26
MARZOLI		54"	59.90	YARD	9	NEW ULTRA		54"	145.00	YARD	22
MAT FINISH		54"	133.00	YARD	21	NEWT		54"	45.00	YARD	5
MATTER		54"	69.90	YARD	14	NEWTOK	27"	54"	65.90	YARD	25
MAX STRIPE	25 1/2"	54"	176.00	YARD	29	NIGHT VINE	36"	1/2"	129.00	YARD	25
MAYBROOK/D	64"	137"	49.80	YARD	5	NILE		54"	59.90	YARD	10
MEGALLI	38"	54"	179.00	YARD	30	NIMBLE		54"	199.90	YARD	
MELATO	16"	54"	44.50	YARD	11	NOHAR	27"	54"	63.90	YARD	20
MENARA	13 1/2"	1/2"	89.00	YARD	18	NOVASUEDE		53"	168.00	YARD	27
MENGIKAT	25"	54"	59.90	YARD	19	NOVETTE RR	5 1/2"	118"	99.00	YARD	
METAL KISS	25"	55"	256.00	YARD	39	NUHIDE		54"	139.00	YARD	20
METAL TILE	14"	1/2"	316.00	YARD	47	NUOSTRICH		54"	139.90	YARD	21
METAL WOOD	20"	53"	316.00	YARD	47	NURATA	23 1/2"	54"	61.90	YARD	16
METALISKIN		54"	149.00	YARD	22	OAK		118"	298.00	YARD	
METALS		54"	145.00	YARD	21	OCEANIC		55"	178.00	YARD	
METIS		54"	59.90	YARD	7	OCELOT	7 1/2"	55"	177.00	YARD	28
MICA		54"	135.00	YARD	21	ODE		118"	176.00	YARD	
MILETUS	27"	54"	43.90	YARD	18	OFF GRID	13 1/2"	1/2"	77.00	YARD	15
MILIEU		54"	145.00	YARD	22	OHENRY/D		54"	29.90	YARD	5
MILLING		54"	63.00	YARD	13	OJITO	29 1/2"	1/2"	199.00	YARD	
MILO		119"	148.00	YARD		OLIA	1"	54"	79.00	YARD	12
MIMOSA		120"	298.00	YARD		OM		54"	139.00	YARD	21
MINDY	5"	54"	79.80	YARD	12	OMBRA		54"	169.90	YARD	24
MINERAL		54"	139.00	YARD	21	ONASSIS/D	26 1/4"	54"	29.90	YARD	5
MINORCA	4 1/2"	54"	55.90	YARD	19	OPHIDIAN		54"	59.90	YARD	9
MIRAJ	25"	54"	49.90	YARD	12	ORISSA/D	13 1/2"	55"	75.00	YARD	5
MIRRORED	2 1/2"	55"	250.00	YARD		ORTONA		52"	95.00	YARD	12
MISSISSIPPI		116"	170.00	YARD		OSSY		54"	47.00	YARD	5
MOCCASIN		54"	129.00	YARD	21	OTTO		54"	69.90	YARD	14
MOCK CROC	13"	53"	298.00	YARD	64	OUTFIELD	12 1/2"	54"	51.50	YARD	14
MOD MOOD		54"	139.00	YARD	22	OUTFITTER	12"	54"	63.90	YARD	16
MOD SUEDE		56"	117.00	YARD	17	OVER UNDER	7"	53"	99.00	YARD	20
MODERN ELEGAN		55"	284.00	YARD	33	OWARI	25"	54"	63.90	YARD	18
MODERN OTTOMA		55"	298.00	YARD	38	OWLISH	27"	54"	149.00	YARD	22
MODULUS	1 1/2"	54"	47.90	YARD	10	PACIFICO	31"	54"	169.00	YARD	
MOHATA	18"	54"	38.90	YARD	9	PAINTERLY		54"	197.00	YARD	32
MONA ZEBRA	27"	54"	119.00	YARD	22	PAISLEYMON	40"	54"	95.00	YARD	22
MONGOLIA	65"	55"	198.00	YARD		PALACE KEY	27"	54"	149.00	YARD	29
MONTIJO		54"	59.90	YARD	9	PALMS/D	27"	54"	67.00	YARD	5
MOONFLOWER	18"	54"	15.90	YARD		PANNA	25 1/4"	54"	51.90	YARD	16
MORISSETTE	18"	55"	149.00	YARD	20	PANTAN	13 1/2"	54"	34.90	YARD	11
MORK		54"	79.80	YARD	10	PANTHERA	16"	55"	270.00	YARD	46
MOSAİK	17"	54"	336.00	YARD		PARKS	25"	1/2"	79.80	YARD	12
MOSSERT		54"	59.90	YARD	5	PARVANI	27"	1/2"	97.00	YARD	19
MOSSERY		54"	59.90	YARD	5	PASNI	25 1/4"	54"	57.90	YARD	16
MURANO		55"	198.00	YARD	33	PATARA	18"	54"	99.80	YARD	21
MURO		54"	139.90	YARD	15	PAVILLON SILK		54"	69.90	YARD	

Prices herein quoted are suggested retail. Prices are subject to change without notice. All shipping and special processing charges are additional.

US Retail Price List - August 2016

Pattern	Repeat	Width	Price	UOM	Grade	Pattern	Repeat	Width	Price	UOM	Grade
PAXON		54"	44.90	YARD	9	RISSIO		54"	15.90	YARD	
PEACEFUL SILK		54"	99.80	YARD	23	RIVERBEND	33"	118"	348.00	YARD	
PEARLUSTER		54"	137.00	YARD	21	RIVERBIRCH	37 1/2"	58"	199.00	YARD	38
PEDERA		120"	230.00	YARD		RLL60950L		45"	44.00	SQFT	
PEKAN	25 1/4"	54"	52.90	YARD	14	RLL60951L		1"	44.00	ROLL	
PELAGOS	7"	1/2"	79.00	YARD	16	RLL60952L		1"	44.00	ROLL	
PELLE		54"	139.90	YARD	15	RLL60953L		50"	44.00	SQFT	
PENGUA	25 1/2"	54"	81.80	YARD	27	RLL60954L		22"	44.00	SQFT	
PENNOCK	5 1/2"	1/2"	79.00	YARD	15	RLL60955L		50"	44.00	SQFT	
PERGOLA		1/2"	248.00	YARD		RLL60956L		50"	44.00	SQFT	
PESCADERO	27"	54"	63.90	YARD	24	RLL60957L		1"	44.00	ROLL	10
PHEASANT	17 1/2"	53"	490.00	YARD		RLL60959L		1"	44.00	ROLL	
PHULKARI	8"	54"	198.00	YARD		RLL60960L		1"	44.00	ROLL	
PIA		54"	69.80	YARD	10	RLL60961L		1"	44.00	ROLL	
PIANI	13 1/2"	54"	59.80	YARD	5	RLL60962L		1"	44.00	ROLL	
PIETRA		54"	159.90	YARD	23	RLL60963L		1"	44.00	ROLL	
PINWHEEL	2 1/2"	54"	139.00	YARD	21	RLL60964L		50"	44.00	SQFT	
PIPERNO	3"	54"	42.90	YARD	15	RLL60965L		50"	44.00	SQFT	
PIX A STIX	13 1/2"	1/2"	79.00	YARD	12	RLL60966L		50"	44.00	SQFT	
PLAINVILLE		54"	99.00	YARD	5	RLL60967L		50"	44.00	SQFT	
PLANO	2"	55"	298.00	YARD	45	RLL60968L		50"	44.00	SQFT	
PLANTES	25"	54"	76.90	YARD	16	RLL60969L		50"	44.00	SQFT	
PLATO		54"	69.00	YARD	9	RLL60970L		1"	44.00	ROLL	
PLAYGROUND	31 1/2"	58"	198.00	YARD		RLL60971L		50"	44.00	SQFT	
PLUSH LIFE		53"	248.00	YARD	34	RLL60972L		1"	44.00	ROLL	
POETICAL	27"	54"	159.00	YARD	33	RLL60973L		1"	44.00	ROLL	
POGGIO	25"	56"	63.90	YARD	24	RLL60974L		50"	44.00	SQFT	
POMPEYA	14 1/2"	117"	248.00	YARD		RLL61100L		40"	44.00	SQFT	
PONTALBA	73 1/2"	55"	176.00	YARD		RLL61101L		50"	44.00	SQFT	
POP FLOWER	7 1/2"	1/2"	99.00	YARD	18	RLL61103L		50"	44.00	SQFT	
POPPYFIELD	25"	1/2"	99.80	YARD	18	RLL61104L		50"	44.00	SQFT	
PORTHOS	7 1/2"	54"	85.80	YARD	13	RLL61105L		1"	44.00	ROLL	
POSTINO	13 1/2"	1/2"	79.00	YARD	19	RLL61106L		1"	44.00	ROLL	
POTS	27"	1/2"	89.00	YARD	11	RLL61107L		50"	44.00	SQFT	
POWMILL	27"	54"	63.90	YARD	17	RLL61108L		22"	44.00	SQFT	
PRESLEY/D	27"	56"	39.90	YARD	5	RLL61110L		22"	44.00	SQFT	
PRIMA		54"	169.90	YARD	24	RLL61111L		22"	44.00	SQFT	
PRINTEMPS	27"	54"	79.80	YARD	14	RLL61112L		50"	44.00	SQFT	
PROSPECT	27"	55"	99.80	YARD	21	RLL61113L		50"	44.00	SQFT	
PULIA	17 1/2"	54"	149.00	YARD	23	RLL61114L		1"	44.00	ROLL	
PUZZEL	6"	54"	296.00	YARD		RLL61115L		1"	44.00	ROLL	
PYXIS		54"	59.90	YARD	9	RLL61116L		1"	44.00	ROLL	
QUALIBAT	26"	54"	199.00	YARD	35	RLL61117L		1"	44.00	ROLL	
RAMPUR	13"	54"	49.90	YARD	13	RLL61118L		1"	44.00	ROLL	
RANJANI	18"	1/2"	79.00	YARD	17	RLL61119L		40"	44.00	SQFT	
RAVAGE		54"	296.00	YARD	30	RLL61120L		1"	44.00	ROLL	
RAVE/D	9 1/2"	54"	49.80	YARD	5	RLL61121L		1"	44.00	ROLL	
REEF	20"	1/2"	398.00	YARD		RLL61122L		8"	44.00	SQFT	
REGATO	27"	1/2"	99.00	YARD	17	RLL61124L		50"	44.00	SQFT	
REPTILIAN	3/4"	55"	290.00	YARD	27	RLL61125L		1"	44.00	ROLL	
RETRO	7 1/2"	51"	99.00	YARD	24	RLL61126L		50"	44.00	SQFT	
REVA		54"	59.90	YARD	9	RLL61127L		50"	44.00	SQFT	
REVIEW/D	9"	54"	49.80	YARD	5	RLL61128L		50"	44.00	SQFT	
RHYME		122"	376.00	YARD	6	RLL61129L		50"	44.00	SQFT	
RHYTHM	13 1/2"	54"	298.00	YARD	51	RLL61130L		50"	44.00	SQFT	
RIAD	9"	55"	87.00	YARD	16	RLL61131L		50"	44.00	SQFT	
RIAD PEARL	9"	55"	89.00	YARD	15	RLL61132L		50"	44.00	SQFT	
RIALTO		1/2"	256.00	YARD		RLL61133L		50"	44.00	SQFT	
RICHGROVE	6"	54"	76.90	YARD	19	RLL61134L		50"	44.00	SQFT	
RIDOLGI	9"	54"	19.90	YARD		RLL61135L		8"	44.00	SQFT	
RIGEL		54"	49.00	YARD	5	RLL61136L		22"	44.00	SQFT	
RIGOLETTO	46"	55"	650.00	YARD		RLL61137L		22"	44.00	SQFT	
RIO GRANDE		54"	59.90	YARD	9	RLL61138L		40"	44.00	SQFT	

Prices herein quoted are suggested retail. Prices are subject to change without notice. All shipping and special processing charges are additional.

US Retail Price List - August 2016

Pattern	Repeat	Width	Price	UOM	Grade	Pattern	Repeat	Width	Price	UOM	Grade
RLL61139L		50"	44.00	SQFT		RLT62016T		1"	20.00	YARD	
RLL65265L			44.00	SQFT		RLT62017T		1"	20.00	YARD	
RLL65266L		22"	44.00	SQFT		RLT62018T		1"	20.00	YARD	
RLL65267L		22"	44.00	SQFT		RLT62019T		1"	20.00	YARD	
RLL65635L	5"	55"	44.00	SQFT		RLT62020T		1"	36.00	YARD	
RLL65636L	5"	55"	44.00	SQFT		RLT62021T		1"	36.00	YARD	
RLL65918L		50"	44.00	SQFT		RLT62022T		1"	36.00	YARD	
RLL65919L		18"	44.00	SQFT		RLT62023T		1"	36.00	YARD	
RLL65920L		18"	44.00	SQFT		RLT62024T		1"	36.00	YARD	
RLT60053T		2"	88.00	YARD		RLT62026T		1"	76.00	YARD	
RLT60109T		11"	200.00	ROLL		RLT62027T		1"	76.00	YARD	
RLT60158T		3"	28.00	YARD		RLT62028T		1"	76.00	YARD	
RLT60172T		2"	100.00	YARD		RLT62029T		1"	76.00	YARD	
RLT60214T		2"	44.00	YARD		RLT62030T		1"	140.00	YARD	
RLT60228T		4"	120.00	YARD		RLT62031T		1"	140.00	YARD	
RLT60235T		7"	200.00	YARD		RLT62032T		1"	140.00	YARD	
RLT60246T		2"	52.00	YARD		RLT62033T		1"	140.00	YARD	
RLT60256T		12"	444.00	ROLL		RLT62034T		1"	140.00	YARD	
RLT60259T		12"	444.00	ROLL		RLT62035T		1"	200.00	YARD	
RLT60344T		1"	24.00	YARD		RLT62036T		1"	200.00	YARD	
RLT60355T		10"	132.00	ROLL		RLT62037T		1"	200.00	YARD	
RLT60358T		10"	132.00	ROLL		RLT62038T		1"	200.00	YARD	
RLT60396T		1"	16.00	YARD		RLT62039T		1"	200.00	YARD	
RLT60403T		1"	16.00	YARD		RLT62040T		1"	300.00	ROLL	
RLT60406T		1"	16.00	YARD		RLT62041T		1"	300.00	ROLL	
RLT60454T		1"	40.00	YARD		RLT62042T		1"	300.00	ROLL	
RLT60491T		1"	24.00	YARD		RLT62043T		1"	300.00	ROLL	
RLT60497T		1"	24.00	YARD		RLT62044T		1"	300.00	ROLL	
RLT60543T		10"	132.00	ROLL		RLT62045T		1"	152.00	YARD	
RLT60544T		10"	132.00	ROLL		RLT62046T		1"	152.00	YARD	
RLT60580T		1"	16.00	YARD		RLT62047T		1"	152.00	YARD	
RLT60581T		1"	16.00	YARD		RLT62048T		1"	152.00	YARD	
RLT60604T		1"	16.00	YARD		RLT62049T		1"	152.00	YARD	
RLT60723T		7"	160.00	ROLL		RLT62050T		1"	104.00	YARD	
RLT60814T		80"	44.00	YARD		RLT62051T		1"	104.00	YARD	
RLT60831T		1"	224.00	YARD		RLT62052T		1"	104.00	YARD	
RLT60834T		1"	338.00	YARD		RLT62053T		1"	104.00	YARD	
RLT60837T		1"	338.00	YARD		RLT62054T		1"	104.00	YARD	
RLT60849T		1"	312.00	YARD		RLT64043T			72.00	YARD	
RLT60850T		1"	312.00	YARD		RLT64044T			160.00	YARD	
RLT60852T		50"	116.00	YARD		RLT64045T			56.00	YARD	
RLT60859T		50"	116.00	YARD		RLT64046T			72.00	YARD	
RLT60862T		90"	188.00	ROLL		RLT64053T			44.00	YARD	
RLT60865T		90"	188.00	ROLL		RLT64054T			44.00	YARD	
RLT60873T		88"	120.00	ROLL		RLT64055T			44.00	YARD	
RLT60893T		1"	376.00	YARD		RLT64057T			56.00	YARD	
RLT60913T		1"	192.00	YARD		RLT64058T			56.00	YARD	
RLT60920T		1"	192.00	YARD		RLT64059T			56.00	YARD	
RLT60938T		90"	240.00	ROLL		RLT64060T			72.00	YARD	
RLT60939T		90"	240.00	ROLL		RLT64061T			72.00	YARD	
RLT61077T		3"	172.00	YARD		RLT64062T			72.00	YARD	
RLT61080T		3"	172.00	YARD		RLT64063T			80.00	YARD	
RLT62000T		1"	20.00	YARD		RLT64064T			80.00	YARD	
RLT62001T		1"	20.00	YARD		RLT64066T			80.00	YARD	
RLT62002T		1"	20.00	YARD		RLT64067T			80.00	YARD	
RLT62003T		1"	20.00	YARD		RLT64069T			128.00	YARD	
RLT62004T		1"	20.00	YARD		RLT64070T			72.00	YARD	
RLT62010T		1"	40.00	YARD		RLT64073T			112.00	YARD	
RLT62011T		1"	40.00	YARD		RLT64074T			160.00	YARD	
RLT62012T		1"	40.00	YARD		RLT64075T			160.00	YARD	
RLT62013T		1"	40.00	YARD		RLT64076T			160.00	YARD	
RLT62014T		1"	40.00	YARD		ROARKE		54"	75.00	YARD	10
RLT62015T		1"	20.00	YARD		RODESA		27" 54"	42.90	YARD	12

Prices herein quoted are suggested retail. Prices are subject to change without notice. All shipping and special processing charges are additional.

US Retail Price List - August 2016

Pattern	Repeat	Width	Price	UOM	Grade	Pattern	Repeat	Width	Price	UOM	Grade
ROMEO		56"	55.00	YARD	5	SO SUBTLE		54"	145.00	YARD	21
ROMEO'S BANDI		7/8"	157.00	YARD		SOFTSUEDE		54"	155.00	YARD	25
ROMFORD	36"	58"	199.00	YARD		SOHO STRIPE		54"	220.00	YARD	25
ROPER	12"	54"	36.50	YARD	8	SOL		54"	59.90	YARD	9
ROSWELL	27"	55"	69.00	YARD	14	SOLARIS		54"	65.00	YARD	9
ROYAL MAZE	13 1/2"	54"	179.00	YARD	22	SOLEN	27"	54"	61.90	YARD	18
ROYALE	36"	54"	99.80	YARD	22	SOLLIS	27"	54"	69.80	YARD	15
RUBINO	25"	55"	330.00	YARD	67	SOLNOVA RR	5 1/2"	118"	99.00	YARD	
RUBY	23 1/2"	54"	298.00	YARD		SOMERSET	18"	55"	129.00	YARD	21
RUCKER		54"	59.90	YARD		SONNET		118"	98.00	YARD	
RUFFUSANO	24"	55"	199.00	YARD	62	SONORA	39 1/2"	55"	298.00	YARD	
RYDELL	23"	54"	67.90	YARD	20	SORIANO	27"	55"	99.00	YARD	17
SABOR	19"	55"	69.00	YARD		SORRENTO	21"	1/2"	350.00	YARD	
SAKISHIMA	9"	54"	59.90	YARD	8	SOVANA	24"	54"	57.90	YARD	16
SALINES	9 1/2"	120"	230.00	YARD		SP-TREVOR	9"	54"	99.00	YARD	17
SALITO	25"	54"	43.00	YARD	18	SP-WESTON	13 1/2"	54"	27.90	YARD	
SALLIE	8"	54"	119.00	YARD	15	SPACE		54"	85.80	YARD	11
SAMARIA	36"	55"	149.00	YARD	29	SPANIEL	38"	60"	196.00	YARD	32
SAN CARLOS	6 3/4"	54"	55.90	YARD	19	SPARKLE		55"	89.00	YARD	13
SANCTUS	12 1/2"	54"	149.00	YARD	23	SPARKS FLY		54"	59.90	YARD	9
SANDBAR/D	24 1/2"	54"	29.90	YARD	5	SPARROWS2	34 1/2"	58"	199.00	YARD	
SANDY POND	13 1/2"	1/2"	79.80	YARD	11	SPARTA		54"	85.00	YARD	11
SANJUAN/D	25"	54"	33.00	YARD	5	SPATTER	27"	54"	59.80	YARD	16
SANTA ROSA	4 1/2"	1/2"	79.00	YARD	10	SPIRO	14"	55"	99.80	YARD	21
SANTOS/D	27"	55"	79.00	YARD	5	SPOTTEDCAT	13 1/2"	1/2"	99.00	YARD	11
SAONA		120"	248.00	YARD		SPROCKET		54"	85.00	YARD	11
SAPPHIRE	23 1/2"	54"	298.00	YARD		SPUN METAL	19"	53"	330.00	YARD	49
SASA		54"	69.90	YARD	14	SPWOODBURY	26 1/2"	54"	95.00	YARD	5
SASHIKO	27"	53"	69.00	YARD	22	STALLIONS	42 1/2"	59"	199.00	YARD	
SASSANID	12 1/2"	54"	63.90	YARD	22	STARGAZ RR	18"	118"	99.00	YARD	
SATIN		53"	250.00	YARD		STARGLOW/D	3 1/4"	54"	29.00	YARD	5
SAVENA	14 1/2"	54"	59.50	YARD	15	STELLINE		54"	79.00	YARD	11
SAVINA		116"	230.00	YARD		STEPS RR	4 1/2"	118"	99.00	YARD	
SCENIC/D	27"	54"	55.00	YARD	5	STEREO		54"	75.00	YARD	10
SCOMA	27"	54"	63.90	YARD	24	STORYBOOK	36"	54"	15.90	YARD	
SCOTLAND		55"	250.00	YARD	36	STRICA		54"	119.00	YARD	24
SCOTTI	1"	54"	77.00	YARD	11	STRIKING		54"	95.00	YARD	
SEA OF LUX		54"	348.00	YARD	40	SUGARCANE	32"	54"	55.90	YARD	17
SEAFIELD	27"	55"	177.00	YARD	37	SULA	24"	52"	296.00	YARD	49
SEBASTIAN	5"	55"	177.00	YARD	32	SULTANA	24"	54"	63.90	YARD	20
SEISMIC		54"	59.90	YARD	9	SUMBA	18"	54"	28.90	YARD	7
SELA		54"	69.90	YARD	10	SUMBAR	41"	1/2"	248.00	YARD	
SELENELION	20 1/2"	54"	79.00	YARD	14	SUNDALE/D	25"	54"	49.80	YARD	5
SENDAL		54"	129.00	YARD	23	SUPER NOVA	5"	1/2"	99.00	YARD	13
SENNA		54"	89.80	YARD	13	SURFSIDE		54"	75.00	YARD	13
SERBINO	5 1/2"	54"	69.00	YARD	14	SURI	36"	54"	49.00	YARD	13
SESHA	13"	54"	79.90	YARD	22	SUTTER		54"	93.00	YARD	11
SESTINA	25"	54"	125.00	YARD	22	SUZANI/D	1 3/4"	54"	37.90	YARD	5
SHAWFARM	9"	54"	55.90	YARD	19	T30051			59.80	EACH	
SHELLS	2 1/4"	54"	47.90	YARD	10	T30053			79.00	EACH	
SHORE/D	26 1/4"	54"	29.90	YARD	5	T30055			39.90	YARD	
SIDE KICK		54"	137.90	YARD	22	T30056			39.90	YARD	
SIGHT LINE	18"	55"	248.00	YARD	31	T30060			19.90	YARD	
SIGNATURE	6"	54"	79.00	YARD	7	T30101			25.00	YARD	
SILVEA	16"	51"	115.00	YARD	19	T30171			25.00	YARD	
SILVERADO	5"	1/2"	99.00	YARD	14	T30172			23.90	YARD	
SILVERLEAF	29 1/2"	54"	376.00	YARD	44	T30175			19.90	YARD	
SIMIA	25 1/4"	54"	47.90	YARD	13	T30176		1/2"	65.00	YARD	
SINTANG	25 1/4"	54"	47.90	YARD	18	T30182			79.00	YARD	
SMOOTHMOVE		54"	169.90	YARD	25	T30183			99.80	YARD	
SNOWHAVEN	28"	52"	197.00	YARD	46	T30186			37.00	YARD	
SO ANGLED		54"	159.00	YARD	24	T30187			157.00	YARD	
SO GATOR		54"	159.80	YARD	25	T30188		1/4"	87.00	YARD	

Prices herein quoted are suggested retail. Prices are subject to change without notice. All shipping and special processing charges are additional.

US Retail Price List - August 2016

Pattern	Repeat Width	Price	UOM	Grade	Pattern	Repeat Width	Price	UOM	Grade
T30189	1/2"	159.00	YARD		T30346		29.00	YARD	
T30190		139.00	YARD		T30347		49.80	YARD	
T30207		77.00	YARD		T30349		25.90	YARD	
T30208		25.00	YARD		T30350		129.00	YARD	
T30209	2"	77.00	YARD		T30353	3/4"	109.00	YARD	
T30210		59.00	YARD		T30357	2"	99.00	YARD	
T30211		99.80	YARD		T30359	1/2"	89.80	YARD	
T30212		37.00	YARD		T30365		119.00	YARD	
T30213		55.00	YARD		T30366		39.90	YARD	
T30214		59.00	YARD		T30367		87.00	YARD	
T30215		145.00	YARD		T30368		29.90	YARD	
T30216		33.00	YARD		T30369		49.80	YARD	
T30219		248.00	EACH		T30373		39.80	YARD	
T30220		49.80	EACH		T30374	3/8"	79.00	YARD	
T30225	1/2"	79.00	YARD		T30375	1/2"	99.00	YARD	
T30226	1/2"	39.00	YARD		T30376		65.00	YARD	
T30233	3/4"	39.90	YARD		T30377		19.90	YARD	
T30234	3/4"	55.00	YARD		T30378		29.80	YARD	
T30235	1/2"	45.00	YARD		T30380		35.00	YARD	
T30236	1"	39.00	YARD		T30385		59.80	EACH	
T30237		45.00	YARD		T30391		59.00	YARD	
T30238		37.00	YARD		T30392		39.90	YARD	
T30240		59.90	YARD		T30393	1/2"	39.90	YARD	
T30241	2"	59.80	YARD		T30394		49.00	YARD	
T30242	1"	75.00	YARD		T30395	2"	49.00	YARD	
T30244		39.90	EACH		T30396		39.80	YARD	
T30250	3/8"	33.00	EACH		T30397		39.00	YARD	
T30255	1/2"	45.00	YARD		T30398	2"	45.00	YARD	
T30256	9"	99.00	YARD		T30401	3/4"	39.90	YARD	
T30257		189.00	YARD		T30402	3/4"	99.00	YARD	
T30259		39.00	YARD		T30403		21.90	YARD	
T30260		55.00	YARD		T30404	1/2"	39.80	YARD	
T30262		169.00	YARD		T30405	1/2"	23.90	YARD	
T30263		93.00	YARD		T30409		197.00	EACH	
T30264	1/2"	149.00	YARD		T30410		139.00	YARD	
T30265	1/2"	75.00	YARD		T30411		33.00	YARD	
T30266		59.00	YARD		T30414		149.00	YARD	
T30267		199.00	YARD		T30415		45.00	YARD	
T30269	1/2"	59.80	YARD		T30417		97.00	YARD	
T30271		149.00	YARD		T30418	1/2"	49.80	YARD	
T30276		39.00	YARD		T30419		264.00	YARD	
T30277		49.00	YARD		T30423		39.00	EACH	
T30287		67.00	YARD		T30424	1"	95.00	YARD	
T30290		29.90	YARD		T30425		49.80	YARD	
T30292		37.00	YARD		T30427	1/2"	45.00	YARD	
T30296		177.00	YARD		T30428	1/2"	39.80	YARD	
T30297	1"	39.00	YARD		T30430	1/2"	96.00	YARD	
T30298		29.80	YARD		T30433		29.00	YARD	
T30299		49.00	YARD		T30434		35.00	YARD	
T30300		49.00	YARD		T30435		25.90	YARD	
T30301	1"	49.80	YARD		T30436		49.80	YARD	
T30305	1/2"	19.00	YARD		T30437		15.90	YARD	
T30308	1/2"	49.00	YARD		T30438		45.00	YARD	
T30313		75.00	YARD		T30439		13.00	YARD	
T30316		17.90	YARD		T30440		99.80	EACH	
T30318	1"	29.90	YARD		T30441		39.90	EACH	
T30321		95.00	YARD		T30442		29.00	EACH	
T30327		59.80	EACH		T30447	2"	85.00	YARD	
T30338	1/2"	39.90	YARD		T30448	1/2"	59.00	YARD	
T30342		29.00	YARD		T30450	1/2"	35.00	YARD	
T30343		19.90	YARD		T30451	3"	85.00	YARD	
T30344		39.90	YARD		T30452	2"	97.00	YARD	
T30345		99.00	YARD		T30453	2"	75.00	YARD	

Prices herein quoted are suggested retail. Prices are subject to change without notice. All shipping and special processing charges are additional.

US Retail Price List - August 2016

Pattern	Repeat	Width	Price	UOM	Grade	Pattern	Repeat	Width	Price	UOM	Grade	
T30454		1"	49.80	YARD		T30569		3/4"	27.90	YARD		
T30455		3"	99.00	YARD		T30570		3/4"	23.90	YARD		
T30456		1"	49.80	YARD		T30571			49.80	YARD		
T30457		2"	179.00	YARD		T30573		1/8"	23.90	YARD		
T30458		1/2"	59.00	YARD		T30576		2"	49.80	YARD		
T30459			77.00	YARD		T30577		1/4"	19.90	YARD		
T30460		1"	59.00	YARD		T30581		1/2"	49.80	YARD		
T30461		7/8"	157.00	YARD		T30582		2"	29.80	YARD		
T30462		8"	145.00	YARD		T30583		3/4"	99.00	YARD		
T30463		1/2"	199.00	YARD		T30584		3/4"	49.80	YARD		
T30467			69.80	YARD		T30585		2"	19.90	YARD		
T30468			69.80	YARD		T30586		2"	45.00	YARD		
T30482			45.00	YARD		T30587		3/4"	19.90	YARD		
T30484			69.80	YARD		T30593		3"	99.00	YARD		
T30486		1/4"	35.60	YARD		T30594		2"	39.00	YARD		
T30487		1/4"	35.60	YARD		T30595		3/4"	13.90	YARD		
T30489		1/4"	39.80	YARD		T30597		3/4"	115.00	YARD		
T30490			39.00	YARD		T30598		3/4"	59.80	YARD		
T30491		2"	39.90	YARD		T30599		1"	21.90	YARD		
T30492			95.00	YARD		T30600		1/4"	139.00	YARD		
T30493		5/8"	11.90	YARD		T30601		1/2"	59.90	YARD		
T30494		3/8"	15.90	YARD		T30602		1"	16.50	YARD		
T30495			19.90	YARD		T30603		2"	35.00	YARD		
T30496		7/8"	39.90	YARD		T30604		3/4"	39.90	YARD		
T30498			79.80	YARD		T30605		1/2"	55.00	YARD		
T30500		3/8"	47.00	YARD		T30606		1/8"	97.00	YARD		
T30501		3/8"	79.80	YARD		T30607		1/2"	97.00	YARD		
T30502		1/2"	99.00	YARD		T30608		1/2"	25.90	YARD		
T30509		1/2"	79.80	YARD		T30609		3"	69.80	YARD		
T30510		1/2"	79.80	YARD		T30611		2"	69.80	YARD		
T30512			17.90	YARD		T30612		3"	129.00	YARD		
T30515			59.00	YARD		T30613		1"	39.80	YARD		
T30516			29.90	YARD		T30614		2"	115.00	YARD		
T30521		7"	65.00	YARD		T30615		1"	21.90	YARD		
T30522			59.00	YARD		T30616		5/8"	21.90	YARD		
T30524			89.80	YARD		T30617		3"	59.80	YARD		
T30525			77.00	YARD		T30618		2"	49.80	YARD		
T30529			75.00	YARD		T30619		3"	99.00	YARD		
T30530			59.80	YARD		T30620		3"	99.00	YARD		
T30531			33.00	YARD		T30621		1"	27.90	YARD		
T30532			25.00	YARD		T30622		1"	55.00	YARD		
T30533			99.00	YARD		T30623		3/4"	2"	67.00	YARD	
T30535			39.80	YARD		T30624		2"	75.00	YARD		
T30536			39.80	YARD		T30625		1/2"	79.80	YARD		
T30544			99.00	YARD		T30626		1/2"	77.00	YARD		
T30545			39.80	YARD		T30627		1"	1"	39.80	YARD	
T30546			69.80	YARD		T30628		3"	59.80	YARD		
T30549		1/4"	15.90	YARD		T30629		2"	45.00	YARD		
T30550		1/4"	15.90	YARD		T30630		1"	29.00	YARD		
T30551		3/8"	25.00	YARD		T30631		1"	29.00	YARD		
T30552		3/8"	45.00	YARD		T30632		1"	77.00	YARD		
T30553		1/2"	21.90	YARD		T30633		1/2"	77.00	YARD		
T30554			29.90	YARD		T30634		3/8"	75.00	YARD		
T30555			39.00	YARD		T30635		1/4"	89.00	YARD		
T30556			49.00	YARD		T30636		3"	69.00	YARD		
T30558		2"	21.90	YARD		T30637		2"	129.00	YARD		
T30559		1/8"	23.90	YARD		T30638		1/2"	35.00	YARD		
T30560		1/4"	29.90	YARD		T30640		1"	33.00	YARD		
T30561		3/4"	49.00	YARD		T30641		4"	119.00	EACH		
T30562		1/8"	17.90	YARD		T30642		1/2"	49.80	YARD		
T30563		1/2"	97.00	YARD		T30644		1/2"	29.00	YARD		
T30564		3/4"	49.80	YARD		T30645		1/2"	53.00	YARD		
T30568		1/2"	21.90	YARD		T30646		1"	19.90	YARD		

Prices herein quoted are suggested retail. Prices are subject to change without notice. All shipping and special processing charges are additional.

US Retail Price List - August 2016

Pattern	Repeat	Width	Price	UOM	Grade	Pattern	Repeat	Width	Price	UOM	Grade
T30647		2"	35.00	YARD		TA5050			39.80	YARD	
T30654		3/4"	23.90	YARD		TA5099			106.00	YARD	
T30655		3/4"	19.90	YARD		TA5100			15.90	YARD	
T30656		1/4"	29.90	YARD		TA5110			25.90	YARD	
T30657		1/2"	29.90	YARD		TA5111			75.00	YARD	
T30671		3/4"	19.80	YARD		TA5112			39.80	YARD	
T30672		1/4"	35.00	YARD		TA5115			49.00	EACH	
T30673		1"	39.80	YARD		TA5117			168.00	EACH	
T30674		1"	39.80	YARD		TA5123			29.90	YARD	
T30675		1/2"	27.80	YARD		TA5134			21.90	YARD	
T30677		1"	39.80	YARD		TA5138			29.90	YARD	
T30680		5/8"	33.90	YARD		TA5144			29.90	YARD	
T30682		1"	23.90	YARD		TA5151			35.00	YARD	
T30683		3/4"	49.90	YARD		TA5153			75.00	YARD	
T30684		3"	53.00	YARD		TA5156			49.80	YARD	
T30686	1 5/8"	1/2"	35.00	YARD		TA5159			29.90	EACH	
T30711		1/8"	59.80	YARD		TA5171			79.80	YARD	
T30712		3/8"	59.80	YARD		TA5173			127.00	YARD	
T30713		3/4"	39.00	YARD		TA5174			21.90	YARD	
T30714		1/2"	49.00	YARD		TA5175			21.00	YARD	
T30715		1/2"	79.80	YARD		TA5176			19.90	YARD	
T30716		1/2"	49.80	YARD		TA5177			47.00	YARD	
T30717		1"	49.00	YARD		TA5178			33.00	YARD	
T30718		1/2"	136.00	YARD		TA5181			37.00	YARD	
T30719		3"	55.00	YARD		TA5188			59.00	YARD	
T30720		1/2"	157.00	YARD		TA5189			27.00	YARD	
T30721		1/2"	37.00	YARD		TA5190	14"		99.90	EACH	
T30723		7/8"	49.90	SET		TA5194			23.90	YARD	
T30724		1/2"	99.00	SET		TA5195			23.90	YARD	
T30725		3/4"	137.00	EACH		TA5196			69.80	YARD	
T30726		1"	45.00	YARD		TA5197			135.00	YARD	
T30727		3/4"	49.00	YARD		TA5198			99.80	YARD	
T30728		3/4"	139.00	YARD		TA5202			117.00	YARD	
T30729		3	119.00	YARD		TA5210			49.00	YARD	
T30730		2	79.80	YARD		TA5211			65.00	YARD	
T30731		1/2"	97.00	YARD		TA5212			55.00	YARD	
T30732		2"	31.80	YARD		TA5213			45.00	YARD	
T30733		1/2"	37.00	YARD		TA5214			39.80	YARD	
T30734		2"	33.90	YARD		TA5216			149.00	YARD	
T30735		1/2"	59.80	YARD		TA5217			177.00	YARD	
T30736		3"	75.00	YARD		TA5225			37.00	YARD	
T30737		7/8"	99.00	YARD		TA5226			169.00	YARD	
T30738		1/4"	13.80	YARD		TA5227			115.00	YARD	
T30739		3"	79.00	YARD		TA5228			39.00	YARD	
T30740		3/8"	149.00	YARD		TA5229	3/8"		29.90	YARD	
T30741	15 1/2"	1/4"	69.00	YARD		TA5231			85.00	YARD	
T30742		0"	177.00	SET		TA5232			39.90	YARD	
T30743		7/8"	37.00	YARD		TA5233			149.00	YARD	
T30744		3"	89.80	YARD		TA5236			169.00	YARD	
T30745		3	89.80	YARD		TA5237			79.00	YARD	
T30746		1/2"	89.80	YARD		TA5238			39.80	YARD	
TA1000			9.00	YARD		TA5239			39.80	YARD	
TA1003			29.90	YARD		TA5254			67.00	YARD	
TA1004			47.00	YARD		TA5257			199.00	YARD	
TA1007			29.90	YARD		TA5271			29.90	YARD	
TA2001			21.90	YARD		TA5281			29.90	YARD	
TA2002			29.90	YARD		TA5298			39.80	YARD	
TA2015			109.00	YARD		TA5299	2"		19.90	YARD	
TA3000			49.80	YARD		TA5305	2"		35.00	YARD	
TA3001			85.00	YARD		TA5308			11.90	YARD	
TA4500			49.80	YARD		TA5310	55"	55"	39.80	YARD	
TA4501			49.80	YARD		TA5311			35.00	YARD	
TA4502			29.90	YARD		TA5312			17.90	YARD	

Prices herein quoted are suggested retail. Prices are subject to change without notice. All shipping and special processing charges are additional.

US Retail Price List - August 2016

Pattern	Repeat	Width	Price	UOM	Grade	Pattern	Repeat	Width	Price	UOM	Grade
TA5313		1/2"	33.00	YARD		UBA	12"	54"	63.90	YARD	17
TA5315		1/2"	35.00	YARD		ULTRASOFT		45"	119.00	YARD	23
TA5317		3"	149.00	YARD		ULTRASUEDE		55"	136.00	YARD	22
TA5322		1/2"	49.00	YARD		UMBRELLAS	41"	58"	199.00	YARD	
TA5323		1/4"	29.90	YARD		UNBRIDLED		54"	159.90	YARD	26
TA5324		2"	39.80	YARD		UNDERSEA	25"	55"	396.00	YARD	
TA5326		1/2"	49.00	YARD		UNICA		54"	169.90	YARD	24
TA5333		1/4"	29.90	YARD		UPATA	18"	54"	55.90	YARD	20
TA5336		3/4"	69.80	YARD		UPSTREAM	27"	55"	79.80	YARD	18
TA5338		1/2"	17.90	YARD		URBAN ZEN	29"	54"	139.00	YARD	21
TA5348		1/4"	45.00	YARD		UTE	25"	54"	197.00	YARD	33
TA5349		3/8"	45.00	YARD		VALAMAS		54"	59.90	YARD	9
TA5358		3/8"	29.00	YARD		VALENTINO	26"	55"	276.00	YARD	
TA5359		1/8"	97.00	YARD		VALERA		54"	59.90	YARD	9
TA5360		3/4"	99.00	YARD		VALPOR/D	26 3/4"	54"	27.90	YARD	5
TA5361		2"	39.00	YARD		VARI	25 1/4"	1/2"	87.00	YARD	18
TA5362		1/8"	35.00	YARD		VASTU	2 1/2"	52"	129.00	YARD	25
TA5363		1/8"	29.90	YARD		VASUKI	13 1/2"	54"	35.90	YARD	9
TA5365		1/2"	99.00	YARD		VELA		5"	79.00	YARD	12
TA5367		1/4"	25.90	YARD		VELINO	36"	1/2"	149.00	YARD	30
TA5368		40"	29.90	YARD		VENUS LIZZO		54"	270.00	YARD	
TA5376		3/4"	29.90	YARD		VERLAINE		54"	63.00	YARD	13
TACHE	8 1/2"	54"	107.90	YARD	24	VERNA/D	26 1/4"	54"	39.00	YARD	5
TAILOR		55"	198.00	YARD		VERNISSE/D	27"	54"	39.90	YARD	5
TALISH	27"	54"	89.00	YARD	18	VERSAILLES		54"	129.00	YARD	20
TANGRAM	36"	52"	169.00	YARD	35	VERSE		122"	248.00	YARD	
TARTAN	4"	54"	298.00	YARD		VICTORIA		54"	148.00	YARD	28
TATAMI		54"	59.90	YARD	9	VICTORIA/D	18"	54"	69.00	YARD	5
TAZZA/D	25 1/2"	54"	47.00	YARD	5	VIDA/D	18 1/4"	54"	49.80	YARD	5
TEABLOSSOM	51"	59"	236.00	YARD	47	VIDOR	4 1/2"	54"	27.90	YARD	6
TECH VIBE		54"	99.00	YARD	11	VINATA	6"	55"	63.90	YARD	14
TED/D	24 1/2"	54"	27.90	YARD	5	VIONNET	9"	1/2"	99.00	YARD	20
TEGAL	25"	54"	55.90	YARD	21	VISIONARY	14 1/2"	56"	177.00	YARD	34
TELOK	25 1/4"	54"	76.90	YARD	22	VITALITY		54"	43.90	YARD	5
TEMARA	23 1/2"	54"	63.90	YARD	22	VITTORIA		54"	59.90	YARD	9
TEMBO		54"	59.90	YARD	8	VOLO		54"	139.90	YARD	15
TEODORO	25"	55"	139.00	YARD	25	VORIK	1"	54"	79.00	YARD	12
TERMEZ	13"	54"	64.90	YARD	16	VOYAGER		54"	149.00	YARD	22
TERRACOTA		55"	198.00	YARD		W3013	25"	1/2"	58.00	ROLL	
TEWA	7"	1/2"	99.00	YARD		W3014	25"	1/2"	49.00	ROLL	
TEXTURAL SILK		54"	129.00	YARD	23	W3016	25"	1/2"	54.00	ROLL	
THALANG	13 1/2"	54"	45.90	YARD	12	W3017	25"	1/2"	58.00	ROLL	
THARSIS	1"	54"	69.00	YARD	9	W3018	25"	1/2"	58.00	ROLL	
TIE DYE	27 1/2"	55"	248.00	YARD	57	W3020	25"	1/2"	58.00	ROLL	
TIFTON		54"	77.00	YARD	10	W3025		1/2"	52.00	YARD	
TIGRESS	27 1/2"	55"	69.00	YARD		W3026		1/2"	52.00	YARD	
TILO		118"	250.00	YARD		W3030	12 1/2"	1/2"	52.00	YARD	
TIRRENO		118"	248.00	YARD		W3036		36"	117.90	ROLL	
TL10026			55.00	YARD		W3037		36"	99.00	ROLL	
TOBAGO		126"	136.00	YARD		W3038		36"	159.90	ROLL	
TOP NOTCH		54"	59.90	YARD	9	W3039		36"	97.90	ROLL	
TOUCH		55"	198.00	YARD		W3040		36"	197.90	ROLL	
TOUSEY	25"	1/2"	99.80	YARD	19	W3041		36"	94.00	ROLL	
TOWSON	4 1/2"	1/2"	129.00	YARD	20	W3042		36"	94.00	ROLL	
TRACERY/D		54"	33.00	YARD	5	W3043		36"	139.90	ROLL	
TRANQUIL SILK		54"	159.00	YARD	31	W3044		36"	79.90	ROLL	
TRAVIATA	53"	56"	436.00	YARD		W3045		36"	94.00	ROLL	
TREADS	12 1/2"	54"	99.80	YARD	18	W3046		36"	108.00	ROLL	
TREAT DU JOUR	1"	55"	296.00	YARD	35	W3047		36"	117.90	ROLL	
TREZZO	10"	54"	63.90	YARD	14	W3048		36"	90.00	ROLL	
TRIPONTI	18"	54"	99.00	YARD	16	W3049		36"	116.00	ROLL	
TULARE	13 1/2"	54"	57.90	YARD	21	W3050		36"	94.00	ROLL	
TURBAN		1/2"	190.00	YARD		W3052		36"	90.00	ROLL	

Prices herein quoted are suggested retail. Prices are subject to change without notice. All shipping and special processing charges are additional.

US Retail Price List - August 2016

Pattern	Repeat	Width	Price	UOM	Grade	Pattern	Repeat	Width	Price	UOM	Grade
W3053		36"	90.00	ROLL		W3152	36"	27"	138.00	ROLL	
W3054		36"	74.00	ROLL		W3153	36"	27"	138.00	ROLL	
W3055		36"	90.00	ROLL		W3154		36"	72.00	YARD	
W3056		36"	158.00	ROLL		W3155		36"	64.00	YARD	
W3057		36"	56.00	ROLL		W3156		36"	94.00	ROLL	17
W3058		36"	108.00	ROLL		W3157		36"	94.00	ROLL	
W3071	21"	27"	78.00	ROLL		W3158		36"	88.00	ROLL	
W3072	21"	27"	78.00	ROLL		W3159		36"	94.00	ROLL	
W3073	21"	27"	78.00	ROLL		W3161		36"	94.00	ROLL	
W3074	21"	27"	78.00	ROLL		W3162		36"	84.00	ROLL	
W3075	21"	27"	78.00	ROLL		W3163		36"	99.90	ROLL	
W3076	21"	27"	78.00	ROLL		W3164		36"	74.00	ROLL	
W3077	21"	27"	78.00	ROLL		W3165		36"	88.00	ROLL	
W3078	21"	27"	78.00	ROLL		W3166		36"	84.00	ROLL	
W3079	21"	27"	78.00	ROLL		W3167		36"	84.00	ROLL	
W3083	21"	27"	78.00	ROLL		W3168		36"	84.00	ROLL	
W3084	21"	27"	78.00	ROLL		W3169		36"	72.00	ROLL	
W3085	21"	27"	78.00	ROLL		W3170		36"	74.00	ROLL	
W3086	21"	27"	78.00	ROLL		W3171		36"	74.00	ROLL	
W3087	21"	27"	78.00	ROLL		W3173		36"	74.00	ROLL	
W3088	21"	27"	78.00	ROLL		W3174		36"	84.00	ROLL	
W3089	25"	1/2"	78.00	ROLL		W3175		36"	94.00	ROLL	
W3090	25"	1/2"	78.00	ROLL		W3176		36"	94.00	ROLL	
W3091	3 1/2"	1/2"	78.00	ROLL		W3177		36"	88.00	ROLL	
W3092	8 1/2"	1/2"	78.00	ROLL		W3178		36"	296.00	ROLL	
W3093		1/2"	78.00	ROLL		W3179		36"	448.00	ROLL	
W3094	25"	25"	78.00	ROLL		W3180		36"	158.00	ROLL	
W3095	36"	27"	78.00	ROLL		W3181		36"	196.00	ROLL	
W3096	25"	27"	78.00	ROLL		W3182		36"	448.00	ROLL	
W3097	21"	27"	70.00	ROLL		W3185		36"	476.00	ROLL	
W3098	36"	27"	78.00	ROLL		W3186		36"	840.00	ROLL	
W3099	25 1/4"	27"	78.00	ROLL		W3187		36"	336.00	ROLL	
W3100	25 1/4"	27"	70.00	ROLL		W3188		36"	398.00	ROLL	
W3101	36"	27"	90.00	ROLL		W3189		36"	436.00	ROLL	
W3102	25 1/4"	27"	70.00	ROLL		W3191		36"	398.00	ROLL	
W3103	25"	35"	178.00	ROLL		W3193		36"	298.00	ROLL	
W3104		36"	136.00	ROLL		W3196		36"	996.00	ROLL	
W3105	36"	36"	178.00	ROLL		W3197		36"	650.00	ROLL	
W3106		36"	130.00	ROLL		W3198		16"	156.00	EACH	
W3107		36"	159.90	ROLL		W3199		16"	156.00	EACH	
W3108		36"	117.90	ROLL		W3200		36"	84.00	ROLL	
W3109		36"	97.90	ROLL		W3201		36"	159.90	ROLL	
W3110		36"	197.90	ROLL		W3202		36"	117.90	ROLL	
W3129	21"	1/2"	74.00	ROLL		W3203		36"	88.00	ROLL	
W3130	25"	1/2"	74.00	ROLL		W3205		36"	199.00	ROLL	
W3131		1/2"	74.00	ROLL		W3206		36"	199.00	ROLL	
W3132	5"	1/2"	68.00	ROLL		W3207		36"	132.00	ROLL	
W3133	21"	1/2"	68.00	ROLL		W3210		36"	139.90	ROLL	
W3134	25"	1/2"	74.00	ROLL		W3211		36"	197.90	ROLL	
W3135		1/2"	68.00	ROLL		W3212		36"	248.00	ROLL	
W3136	21"	1/2"	68.00	ROLL		W3214		36"	129.00	ROLL	
W3137	2"	1/2"	74.00	ROLL		W3221	27"	34"	484.00	ROLL	
W3139	6 3/4"	1/2"	74.00	ROLL		W3222	17"	34"	484.00	ROLL	
W3140	21"	1/2"	59.00	ROLL		W3223		36"	132.00	ROLL	
W3141		1/2"	59.00	ROLL		W3224		36"	156.00	ROLL	
W3142	26"	1/2"	199.00	ROLL		W3225		36"	156.00	ROLL	
W3143	26"	36"	136.00	ROLL		W3226		36"	132.00	ROLL	
W3144		36"	99.00	ROLL		W3227		36"	132.00	ROLL	
W3145	10 1/2"	1/2"	49.00	ROLL		W3228		36"	132.00	ROLL	
W3146		36"	138.00	YARD		W3229		36"	132.00	ROLL	
W3147		36"	840.00	ROLL		W3231		36"	284.00	ROLL	
W3150	7"	27"	138.00	ROLL		W3234		36"	99.80	ROLL	
W3151	7"	27"	138.00	ROLL		W3235		36"	216.00	ROLL	

Prices herein quoted are suggested retail. Prices are subject to change without notice. All shipping and special processing charges are additional.

US Retail Price List - August 2016

Pattern	Repeat	Width	Price	UOM	Grade	Pattern	Repeat	Width	Price	UOM	Grade
W3239		36"	284.00	ROLL		W3321	25	1/2" 54"	177.00	ROLL	
W3241		36"	99.00	ROLL		W3323	25	1/2" 27"	99.00	ROLL	
W3242		36"	99.00	ROLL		W3324	6	1/2" 27"	99.00	ROLL	
W3243		36"	99.00	ROLL		W3327	25	1/2" 27"	99.00	ROLL	
W3244		36"	99.00	ROLL		W3328	25	1/2" 27"	99.00	ROLL	
W3245		36"	159.90	ROLL		W3333		36"	126.90	ROLL	
W3246		36"	99.90	ROLL		W3334		36"	116.90	ROLL	
W3248		36"	99.90	ROLL		W3337	12	1/2" 27"	54.90	ROLL	
W3249		36"	99.90	ROLL		W3338	20	1/2" 27"	56.90	ROLL	
W3250		36"	298.00	ROLL		W3339	20	1/2" 27"	44.90	ROLL	
W3251		36"	197.90	ROLL		W3340	25	1/2" 27"	54.90	ROLL	
W3252		42"	99.00	YARD		W3341		24" 27"	44.90	ROLL	
W3253		42"	79.00	YARD		W3342	12	1/2" 27"	126.90	ROLL	
W3254		42"	99.00	YARD		W3343	6	1/2" 27"	126.90	ROLL	
W3255		42"	99.00	YARD		W3344	20	1/2" 27"	62.90	ROLL	
W3256		45"	120.00	YARD		W3345	12	1/2" 27"	62.90	ROLL	
W3257		45"	140.00	YARD		W3346	12	1/2" 27"	126.90	ROLL	
W3258		46"	144.00	YARD		W3347		36"	162.90	ROLL	
W3259		54"	144.00	YARD		W3348	25	1/2" 27"	54.90	ROLL	
W3260		54"	144.00	YARD		W3349	20	1/2" 27"	44.90	ROLL	
W3261		45"	140.00	YARD		W3350		24" 27"	44.90	ROLL	
W3263		36"	108.00	ROLL		W3351	6	1/2" 27"	72.90	ROLL	
W3264		36"	159.90	ROLL		W3352		13" 27"	54.90	ROLL	
W3265		36"	298.00	ROLL		W3353		24" 27"	44.90	ROLL	
W3266		36"	99.00	ROLL		W3355		36"	180.90	ROLL	
W3267		46"	199.00	YARD		W3356		24" 27"	44.90	ROLL	
W3275		36"	125.90	ROLL		W3357		24" 27"	44.90	ROLL	
W3276		36"	125.90	ROLL		W3358	12	1/2" 27"	54.90	ROLL	
W3277		36"	67.90	ROLL		W3359	12	1/2" 27"	54.90	ROLL	
W3278		1/2"	99.90	ROLL		W3360	25	1/2" 27"	135.90	ROLL	
W3279		1/2"	109.90	ROLL		W3361		36"	224.90	YARD	
W3280		1/2"	169.90	ROLL		W3362		25" 27"	62.90	ROLL	
W3281		36"	125.90	ROLL		W3363	12	1/2" 27"	72.90	ROLL	
W3282		36"	125.90	ROLL		W3364		36"	260.90	ROLL	
W3283		36"	153.90	ROLL		W3365	20	1/2" 1/2"	62.90	ROLL	
W3284		36"	136.00	ROLL		W3367		25" 27"	62.90	ROLL	
W3285		36"	199.90	ROLL		W3368		25" 27"	56.90	ROLL	
W3286		36"	224.00	ROLL		W3369	25	1/2" 27"	72.90	ROLL	
W3287		36"	125.90	ROLL		W3370		25" 27"	54.90	ROLL	
W3288		36"	145.90	ROLL		W3371		27"	72.90	ROLL	
W3289		36"	145.90	ROLL		W3372	12	1/2" 27"	54.90	ROLL	
W3291		36"	199.90	ROLL		W3374	25	1/2" 27"	59.90	ROLL	
W3292		36"	153.90	ROLL		W3376		27"	59.90	ROLL	
W3293		36"	135.90	ROLL		W3377	12	5/8" 27"	135.90	ROLL	
W3294		36"	145.90	ROLL		W3378	25	1/2" 27"	52.90	ROLL	
W3295		36"	145.90	ROLL		W3379		27"	59.90	ROLL	
W3296		36"	145.90	ROLL		W3380	25	1/2" 27"	59.90	ROLL	
W3297	27"	27"	177.00	ROLL		W3381		27"	72.90	ROLL	
W3298		46"	144.00	YARD		W3382	25	1/2" 27"	54.90	ROLL	
W3300		36"	298.00	ROLL		W3383	6	1/2" 27"	59.90	ROLL	
W3302		36"	250.00	ROLL		W3384	25	1/2" 27"	135.90	ROLL	
W3303		36"	350.00	ROLL		W3385	8	1/2" 27"	135.90	ROLL	
W3306		36"	178.00	ROLL		W3386	25	1/2" 27"	135.90	ROLL	
W3309		36"	394.00	ROLL		W3388	12	1/2" 27"	54.90	ROLL	
W3310		36"	250.00	ROLL		W3389		39"	1026.00	YARD	
W3311		36"	198.00	ROLL		W3390		39"	570.00	YARD	
W3312		36"	178.00	ROLL		W3391		39"	720.00	YARD	
W3313		36"	178.00	ROLL		W3392		39"	558.00	YARD	
W3314		36"	178.00	ROLL		W3393		39"	558.00	YARD	
W3315		36"	250.00	ROLL		W3394		39"	548.00	YARD	
W3317		36"	250.00	ROLL		W3395		39"	396.00	YARD	
W3318		36"	350.00	ROLL		WABASH	6	1/2" 1/2"	79.00	YARD	10
W3319		36"	350.00	ROLL		WAIKIKI2/D		27" 54"	59.00	YARD	5

Prices herein quoted are suggested retail. Prices are subject to change without notice. All shipping and special processing charges are additional.

US Retail Price List - August 2016

Pattern	Repeat	Width	Price	UOM	Grade	Pattern	Repeat	Width	Price	UOM	Grade
WALMSLEY	13	1/2"	1/2"	95.00	YARD	20 WHF3094	54"	58.00	YARD		
WARWICK/D		27"	54"	65.00	YARD	5 WHF3095	54"	58.00	YARD		
WATER TINT		23"	54"	199.00	YARD	47 WHF3096	54"	58.00	YARD		
WATERPOLO		27"	1/2"	119.00	YARD	19 WHF3097	54"	58.00	YARD		
WATERWAVE		27"	55"	79.80	YARD	19 WHF3098	54"	58.00	YARD		
WAVYSTRIP		25"	57"	199.00	YARD	45 WHF3099	54"	58.00	YARD		
WAY TO GO			54"	157.00	YARD	25 WHF3100	54"	58.00	YARD		
WEALDEN		18"	54"	42.90	YARD	16 WHF3101	54"	58.00	YARD		
WEATHERED	19	1/2"	44"	248.00	YARD	79 WHF3102	54"	58.00	YARD		
WEEKAPAUG		18"	54"	71.90	YARD	20 WHF3105	54"	58.00	YARD		
WEIMAR			56"	248.00	YARD	WHF3106	54"	58.00	YARD		
WEYFORD			54"	93.00	YARD	11 WHF3107	54"	58.00	YARD		
WHF3000			54"	58.00	YARD	WHF3108	54"	58.00	YARD		
WHF3001			54"	58.00	YARD	WHF3109	54"	58.00	YARD		
WHF3002			54"	58.00	YARD	WHF3110	54"	58.00	YARD		
WHF3003			54"	58.00	YARD	WHF3111	54"	58.00	YARD		
WHF3004			54"	58.00	YARD	WHF3112	54"	58.00	YARD		
WHF3005			54"	58.00	YARD	WHF3113	54"	58.00	YARD		
WHF3006			54"	58.00	YARD	WHF3114	54"	58.00	YARD		
WHF3007			54"	58.00	YARD	WHF3115	54"	58.00	YARD		
WHF3008			54"	58.00	YARD	WHF3116	54"	58.00	YARD		
WHF3009			54"	58.00	YARD	WHF3117	54"	58.00	YARD		
WHF3010			54"	58.00	YARD	WHF3118	54"	58.00	YARD		
WHF3011			54"	58.00	YARD	WHF3119	54"	58.00	YARD		
WHF3012			54"	58.00	YARD	WHF3120	54"	58.00	YARD		
WHF3015			54"	58.00	YARD	WHF3121	54"	58.00	YARD		
WHF3016			54"	58.00	YARD	WHF3122	54"	58.00	YARD		
WHF3017			54"	58.00	YARD	WHF3123	54"	58.00	YARD		
WHF3018			54"	58.00	YARD	WHF3124	54"	58.00	YARD		
WHF3019			54"	58.00	YARD	WHF3125	54"	58.00	YARD		
WHF3020			54"	58.00	YARD	WHF3126	54"	58.00	YARD		
WHF3021			54"	58.00	YARD	WHF3127	54"	58.00	YARD		
WHF3045			54"	58.00	YARD	WHF3128	54"	58.00	YARD		
WHF3046			54"	58.00	YARD	WHF3129	54"	58.00	YARD		
WHF3047			54"	58.00	YARD	WHF3130	54"	58.00	YARD		
WHF3048			54"	58.00	YARD	WHF3131	54"	58.00	YARD		
WHF3049			54"	58.00	YARD	WHF3132	54"	58.00	YARD		
WHF3050			54"	58.00	YARD	WHF3133	54"	58.00	YARD		
WHF3051			54"	58.00	YARD	WHF3134	54"	58.00	YARD		
WHF3052			54"	58.00	YARD	WHF3135	54"	58.00	YARD		
WHF3053			54"	58.00	YARD	WHF3136	54"	58.00	YARD		
WHF3054			54"	58.00	YARD	WHF3137	54"	58.00	YARD		
WHF3055			54"	58.00	YARD	WHF3138	54"	58.00	YARD		
WHF3056			54"	58.00	YARD	WHF3139	54"	58.00	YARD		
WHF3057			54"	58.00	YARD	WHF3140	54"	58.00	YARD		
WHF3064			54"	58.00	YARD	WHF3141	54"	58.00	YARD		
WHF3065			54"	58.00	YARD	WHF3142	54"	58.00	YARD		
WHF3066			54"	58.00	YARD	WHF3143	54"	58.00	YARD		
WHF3067			54"	58.00	YARD	WHF3144	54"	58.00	YARD		
WHF3068			54"	58.00	YARD	WHF3145	54"	58.00	YARD		
WHF3069			54"	58.00	YARD	WHF3146	54"	58.00	YARD		
WHF3070			54"	58.00	YARD	WHF3147	54"	58.00	YARD		
WHF3076			52"	168.00	YARD	WHF3150	54"	58.00	YARD		
WHF3077			52"	168.00	YARD	WHF3151	54"	58.00	YARD		
WHF3078			52"	168.00	YARD	WHF3152	54"	58.00	YARD		
WHF3079			52"	168.00	YARD	WHF3153	54"	58.00	YARD		
WHF3080			52"	168.00	YARD	WHF3154	54"	58.00	YARD		
WHF3081			52"	168.00	YARD	WHF3155	54"	58.00	YARD		
WHF3082			52"	168.00	YARD	WHF3156	54"	58.00	YARD		
WHF3090			54"	58.00	YARD	WHF3157	54"	58.00	YARD		
WHF3091			54"	58.00	YARD	WHF3158	54"	58.00	YARD		
WHF3092			54"	58.00	YARD	WHF3163	54"	58.00	YARD		
WHF3093			54"	58.00	YARD	WHF3164	54"	58.00	YARD		

Prices herein quoted are suggested retail. Prices are subject to change without notice. All shipping and special processing charges are additional.

US Retail Price List - August 2016

Pattern	Repeat	Width	Price	UOM	Grade	Pattern	Repeat	Width	Price	UOM	Grade
WHF3165		54"	58.00	YARD		ZDEL-LWP67038		36"	176.00	ROLL	
WHF3166		54"	58.00	YARD		ZDEL-LWP67039		36"	176.00	ROLL	
WHF3167		54"	58.00	YARD		ZDEL-LWP67040		36"	176.00	ROLL	
WHF3168		54"	58.00	YARD		ZDEL-LWP67041		36"	176.00	ROLL	
WHF3169		54"	58.00	YARD		ZDEL-LWP67049	24"	36"	56.00	ROLL	
WHF3170		54"	58.00	YARD		ZDEL-LWP67050	24"	36"	56.00	ROLL	
WHF3171		54"	58.00	YARD		ZDENKA	25"	54"	57.90	YARD	17
WHF3172		54"	58.00	YARD		ZEBRA	28 1/2"	59"	179.00	YARD	33
WHF3173		54"	58.00	YARD		ZEBREE	27"	54"	169.00	YARD	27
WHF3174		54"	58.00	YARD		ZERBINO	5 1/2"	54"	69.00	YARD	14
WHF3175		54"	58.00	YARD		ZIGGY		54"	149.00	YARD	22
WHF3178		52"	168.00	YARD		ZULIA	7"	54"	63.90	YARD	21
WHF3179		52"	168.00	YARD		ZUMA	13 1/2"	55"	99.00	YARD	19
WHF3180		52"	168.00	YARD			54"	129.00	YARD	23	
WHF3181		52"	168.00	YARD							
WHF3182		52"	168.00	YARD							
WHF3183		52"	168.00	YARD							
WHF3184		52"	168.00	YARD							
WHF3192		54"	58.00	YARD							
WHF3193		54"	58.00	YARD							
WHF3194		54"	58.00	YARD							
WHF3195		54"	58.00	YARD							
WHF3196		54"	58.00	YARD							
WHF3197		54"	58.00	YARD							
WHF3198		54"	58.00	YARD							
WHF3199		54"	58.00	YARD							
WHF3200		54"	58.00	YARD							
WHF3201		54"	58.00	YARD							
WHF3202		54"	58.00	YARD							
WHF3203		54"	58.00	YARD							
WHF3204		54"	58.00	YARD							
WHF3205		54"	58.00	YARD							
WHF3206		54"	58.00	YARD							
WHF3207		54"	58.00	YARD							
WHF3208		54"	58.00	YARD							
WHIMSICAL		31"	58"	248.00	YARD						
WHIRL/D	25	1/4"	54"	31.90	YARD	5					
WHOA NELLY	7	1/2"	54"	145.00	YARD	22					
WILDCAT	7	1/2"	55"	177.00	YARD	28					
WINDSOR		56"	296.00	YARD	86						
WINSTON/D	26	1/2"	54"	95.00	YARD	5					
WISP		7"	54"	63.90	YARD	14					
WISTFUL/D	26	1/2"	54"	33.00	YARD	5					
WOOD FROST		27"	54"	177.00	YARD						
WOODLAWN		27"	1/2"	95.00	YARD	21					
WOODMORE/D		27"	54"	59.00	YARD	5					
WOODROSE		27"	54"	55.00	YARD	20					
WOW NOVA RR	5	1/2"	118"	99.00	YARD						
WREXHAM		27"	54"	62.90	YARD	16					
XU GARDEN	13	1/2"	55"	99.80	YARD	20					
YORKVILLE	6	1/2"	1/2"	79.80	YARD	18					
ZAGORA		18"	54"	57.90	YARD	20					
ZANTE	13	1/2"	54"	44.90	YARD	17					
ZARIA	13	1/2"	54"	65.90	YARD	18					
ZDEL-LWP67012	13	3/8"	27"	188.00	ROLL						
ZDEL-LWP67013	13	3/8"	27"	188.00	ROLL						
ZDEL-LWP67014	13	3/8"	27"	188.00	ROLL						
ZDEL-LWP67015	24	3/4"	36"	98.00	ROLL						
ZDEL-LWP67019		54"	130.00	ROLL							
ZDEL-LWP67023		36"	150.00	ROLL							
ZDEL-LWP67024		36"	150.00	ROLL							
ZDEL-LWP67029		36"	358.00	ROLL							
ZDEL-LWP67030		36"	358.00	ROLL							

Prices herein quoted are suggested retail. Prices are subject to change without notice. All shipping and special processing charges are additional.

WHOLESALE
TRADE PRICE LIST
EFFECTIVE
JANUARY 4, 2016

ROBERT ALLEN CONTRACT



ROBERT ALLEN CONTRACT

INDEX

Fabrics	2-6
Special Fabric Finishes	7

ROBERT ALLEN CONTRACT

PATTERN	PIECE PRICE	PATTERN	PIECE PRICE	PATTERN	PIECE PRICE	PATTERN	PIECE PRICE
3D BLOCKS	\$22.00	BALFOUR	\$26.70	BRAIDED TWIST	\$42.95	CHERICO	\$41.95
3D VIEW	\$20.00	BALMY	\$17.35	BRAZOS	\$4.50	CHEVONNE	\$31.00
AALIYAH	\$38.95	BALTIC CUFF	\$21.95	BREAKING NEWS	\$22.00	CHEVRON BOUCLE	\$23.95
ABBNEYDALE	\$31.35	BANDERILLA	\$24.95	BRECKSVILLE	\$25.10	CHEVRON BOUCLE	\$24.00
ABLE BLOCK	\$39.00	BANDEROLES	\$63.95	BREMOND	\$15.95	CHEVRON IKAT	\$40.95
ABOUT FACE	\$32.95	BANE BERRY LANE	\$19.95	BRICK BOX	\$29.00	CHEVRON STITCH	\$38.00
ABSTRACT IKAT	\$15.95	BARBADOS	\$47.50	BRIGHT BLOCKS	\$21.00	CHEVRON STRIE	\$36.00
ABSTRACT PLAID	\$45.95	BARELY THERE	\$16.75	BRIGHT EYES	\$26.00	CHIC BOUCLE	\$34.45
ACHILL ISLAND	\$25.95	BARKERVILLE	\$28.95	BRILLIANTINE	\$56.00	CHICO	\$15.95
ADDERTON	\$29.00	BARKIN	\$24.95	BRITE OUTLOOK	\$19.95	CHILLIN	\$34.45
ADDYSON	\$14.95	BARRATEEN	\$20.00	BRIXTON	\$29.25	CHROMAPIXEL	\$35.95
ADVISOR	\$39.20	BARRIER	\$48.50	BROADLINES	\$24.95	CIGAR BOX	\$65.50
AFTER HOURS	\$33.95	BASALT	\$28.20	BROMSTAD	\$39.00	CIRCLE AROUND	\$22.95
ALBERTSON	\$29.25	BASIC STITCH	\$30.00	BROOKS RANGE	\$31.00	CIRCLE ART	\$46.00
ALBION	\$40.95	BASKET STITCH	\$25.00	BRUSHWORK	\$40.95	CIRCLE ROW	\$27.95
ALGEBRAIC	\$28.20	BASKET WEDGE	\$15.95	BRUTUS	\$23.00	CIRCLE TEXTURE	\$9.95
ALGOMA	\$11.60	BATTEN DOWN	\$51.10	BRUTUS	\$20.95	CIRCLE TRELIS	\$63.95
ALL IN CHECK	\$64.00	BATTERSEA	\$28.80	BUILDING BLOCK	\$34.00	CIRCLE WITHIN	\$25.95
ALL THAT JAZZ	\$33.95	BEAD STRIPE	\$34.95	BUKHARA	\$38.95	CLAREMORRIS	\$27.95
ALTER EGO	\$30.30	BEATRIX	\$23.05	BULLION BARS	\$35.00	CLASSIC DESIGN	\$40.95
AMBO	\$32.00	BEAUTY REMAINS	\$15.25	BULLION TRAIL	\$27.75	CLASSIC STRIPE	\$14.00
AMHERST	\$35.95	BEDECKED	\$15.00	BUTTERFIELD	\$30.30	CLASSIC WEAVE	\$21.45
AMPHORA	\$24.95	BEFITTING	\$20.00	CABANA	\$15.95	CLEAN LINES	\$30.95
ANANZI	\$23.95	BEGIN AGAIN	\$38.95	CABANA BAR	\$65.00	CLEAR INTENT	\$23.00
ANCHOR CHAIN	\$46.95	BELLA LUNA	\$29.25	CABLESTITCH	\$9.95	CLINGING VINES	\$35.00
ANCIENT PERSIA	\$45.00	BELLA NOVA	\$24.05	CADET	\$30.30	CLIPPED FRAME	\$44.80
ANGELO	\$31.00	BELLE AMI	\$12.60	CADOGAN	\$35.50	CLIPPER SOLID	\$32.35
ANGLED QUAD	\$31.95	BELNORD	\$29.25	CAGE HEAT	\$41.00	CLIQUE	\$27.75
ANSWER	\$38.15	BENDABLE	\$42.00	CAIRO BAZAAR	\$127.00	COBBLE LANE	\$37.55
ANTHOLOGY	\$24.95	BEQUEST	\$35.50	CALLISBURG	\$19.95	COCHLEAR	\$32.95
ANTIGUA	\$38.15	BERRY STEMS	\$24.60	CALM WATERS	\$19.95	COLIN	\$14.95
ANY OTHER DAY	\$38.95	BETWEEN LINES	\$86.00	CALYPSO NIGHT	\$34.45	COLLABORATE	\$29.80
APARICIO	\$35.95	BIG EASY	\$34.45	CAMEO SCROLL	\$25.95	COLLINSVILLE	\$19.95
APOLLINAIRE	\$41.95	BIG KAHUNA	\$34.45	CAMRYN	\$31.00	COLONY HILL	\$39.95
APPLE TREE	\$15.95	BILLIARD	\$30.30	CANDLEWAY	\$29.25	COLOR EFFECT	\$32.00
APRIL LOVE	\$12.50	BINTO	\$26.00	CANTORIAL	\$45.95	COLOR PATCH	\$25.95
ARABESQUE	\$41.95	BIRDSEYE VIEW	\$15.95	CANVAS SHEEN	\$15.95	COLOR SPLASH	\$30.00
ARBORFORM	\$45.95	BISTOLFI	\$36.95	CANVAS TEXTURE	\$16.00	COLTIN	\$18.00
ARCIFORM	\$50.95	BLAKE	\$19.00	CAPSULE	\$34.50	CONNECTED DOTS	\$31.95
ARGYLE CHECK	\$28.20	BLAKE STRIPE	\$25.95	CAROLINE ISLE	\$23.05	CONNECTED ROWS	\$33.95
ARISTON	\$31.35	BLING BLING	\$37.10	CARRICK BEND	\$44.85	CONSTELLATION	\$40.95
ARROWPOINT	\$35.50	BLISSFUL	\$29.95	CARTELLIER	\$27.95	CONTOURED LEAF	\$24.60
ASHEVILLE	\$36.95	BLOSSOM TIME	\$24.60	CASS	\$38.95	COOL BAYOU	\$34.45
ASPERITY	\$28.80	BLUE HILL	\$31.35	CASTLE POINT	\$32.00	CORNER SQUARE	\$15.95
ASTERLING	\$26.95	BLURRED LINES	\$62.00	CATA RINGS	\$55.00	COSTONMIRIS	\$31.35
ATLANTIS REEF	\$39.65	BOCA LINDA	\$31.95	CAYMAN BRAC	\$28.20	CREAM PUFFS	\$42.75
ATRIUM	\$44.95	BOCCIA	\$45.00	CEDAR SPRINGS	\$31.95	CREATIVE GEO	\$39.00
ATTITUDE	\$37.55	BOLD LINKS	\$32.00	CELOSIA	\$28.20	CREEK BED	\$32.35
AUBREY SOLID	\$30.00	BOLD RINGS	\$30.95	CENTERVILLE	\$28.50	CRESWICK	\$29.95
AUTUMN BREEZE	\$35.50	BOTANY	\$28.20	CENTRAL STRIPE	\$29.95	CRINKLED SHEER	\$8.45
AUTUMN SCENE	\$29.95	BOUCLE SOLID	\$15.95	CHAINS	\$74.95	CRONOS	\$35.00
AZTEC FIELD	\$28.20	BOUCLE TAPE	\$34.95	CHANDRIMA	\$25.95	CROSS VINES	\$45.00
AZTEC PATHWAY	\$15.95	BOVINE FLOCK	\$23.95	CHARLO	\$31.95	CROWN JEWELS	\$35.00
BACK AND FORTH	\$35.95	BOX ILLUSION	\$28.95	CHARM CITY	\$38.95	CROWN MANOR	\$29.25
BAHAMA STRIPES	\$35.95	BOX JUNCTION	\$25.95	CHATTING CHICKS	\$38.00	CRUELLA	\$44.35
BAHAMARAMA	\$34.45	BOX MOTION	\$27.15	CHECKED LINES	\$15.95	CRYPTON SUEDE	\$28.00
BALDACCINI	\$27.95	BOXED PLAID	\$46.00	CHECKER GAME	\$31.35	CURLY LEAF	\$25.95
BALFE	\$37.10	BOYLAN	\$25.65	CHENILLE WAVES	\$28.95	CURVY	\$15.95

WHOLESALE TRADE PRICE LIST
800.333.3778

ROBERT ALLEN accepts MasterCard, Visa® and American Express

ROBERT ALLEN CONTRACT

PATTERN	PIECE PRICE	PATTERN	PIECE PRICE	PATTERN	PIECE PRICE	PATTERN	PIECE PRICE
DAGETT	\$17.00	DRUMCONDRA	\$20.95	FEEDBACK	\$29.25	GLACIER BAY	\$55.25
DAISY VASE	\$15.95	DURINDA STRIPE	\$17.95	FELLOW	\$32.00	GLACIER ICE	\$39.95
DANCE ALONG	\$34.00	DYNAMIC BARS	\$33.95	FENCED IN	\$22.00	GLAMOUR LOOK	\$30.95
DANEAU	\$30.95	EAST HORIZON	\$15.95	FENCING	\$23.95	GLAZED LINEN	\$53.95
DAWNING SUN	\$38.95	ECHO MANOR	\$13.95	FIESTA KEY	\$31.95	GLEN ROSE	\$26.00
DECO DOT	\$40.95	ECO ARIA	\$34.00	FILIGREE	\$41.95	GLENFINNAN	\$30.95
DECORAH	\$22.95	ECO BALANCE	\$36.00	FINE LIVING	\$35.95	GLIMMER EFFECT	\$32.00
DECORATING FUN	\$23.95	ECO BOUCLE	\$30.00	FINE TEXTURE	\$20.00	GLIMMER SEQUIN	\$43.95
DEDHAM SQUARE	\$23.00	ECO CANYON	\$22.95	FINISH LINE	\$42.00	GLIMMER STAR	\$35.00
DEEPLY YOURS	\$35.00	ECO CENTRIC	\$27.15	FIRE BRICKS	\$29.95	GLOBAL ACTION	\$22.50
DEFINITY	\$27.15	ECO CIRCLE	\$24.05	FLAWLESS	\$32.95	GLOBAL IKAT	\$15.95
DEGEORGE	\$36.95	ECO COOL	\$35.50	FLEURS APLENTY	\$36.55	GLOBAL LUXURY	\$28.20
DELACORTE	\$20.40	ECO DASH	\$28.95	FLIP UP	\$29.00	GLOBAL TEXTURE	\$10.35
DIAMOND ARCH	\$20.00	ECO ESQUE	\$29.95	FLITTER	\$35.50	GLORYBEE	\$25.95
DIAMOND CURVE	\$15.95	ECO FINALE	\$38.00	FLOOR PLAN	\$38.95	GLOSSY STRIPES	\$31.00
DIAMOND DUST	\$30.30	ECO FINITY	\$38.00	FLORAL GRACE	\$31.35	GLYMUR	\$29.25
DIAMOND FACETS	\$55.00	ECO FRESH	\$25.95	FLORAVILLE	\$29.00	GO SHEER	\$25.00
DIAMOND ISLE	\$34.00	ECO GRACE	\$29.95	FOLLOW ME	\$30.95	GORDIAN KNOT	\$33.00
DIAMOND LINES	\$12.95	ECO IMPACT	\$34.95	FORCEFIELD	\$48.50	GORDIAN KNOT	\$32.00
DIAMOND MOTIF	\$31.35	ECO LANE	\$28.95	FORTITUDE	\$46.50	GOTHENBURG	\$24.95
DIAMOND NET	\$50.05	ECO LORING	\$35.95	FOSSIL INLAY	\$35.95	GRACEFUL SWIRL	\$34.95
DIAMOND PICK	\$16.50	ECO NOD	\$33.00	FOSSIL LEAF	\$22.00	GRADIENT	\$16.00
DIAMOND SCROLL	\$37.55	ECO OHNO	\$27.95	FOUR LEAF	\$15.95	GRAFFITI RINGS	\$28.20
DIAMOND STEP	\$33.40	ECO PAISLEY	\$20.95	FOUR STAR	\$15.95	GRAND CAYMAN	\$41.75
DIAMOND STRAND	\$31.95	ECO PARK	\$41.95	FOX HOLLOW	\$35.50	GRAND CENTRAL	\$26.15
DIAMOND TUCK	\$31.95	ECO PASSAGE	\$29.95	FOXVALE	\$11.95	GRAND CIRCLE	\$39.00
DIAMOND VIEW	\$35.00	ECO QUILT	\$33.95	FRACTAL	\$9.95	GRAND LAUREL	\$32.95
DIAMOND ZONE	\$15.95	ECO ROAD	\$21.95	FRACTURED CAMO	\$38.00	GRAPHIC MAZE	\$43.95
DIGITAL BLOCKS	\$45.00	ECO SQUARE	\$26.15	FRENZY LEAF	\$26.70	GRAPHIC NATURE	\$41.00
DIGITAL PATH	\$54.00	ECO TIME	\$35.00	FREQUENCY	\$30.30	GRASS HUT	\$34.45
DIGITAL WAVE	\$35.00	ECO VILLAGE	\$36.55	FRESH MELODY	\$31.00	GRASSY KNOLL	\$30.30
DIRECTOR	\$45.50	EDGE STITCH	\$42.00	FRETWORK DECOR	\$34.00	GREELY	\$31.35
DISCO DOTS	\$33.95	EDGE STITCH	\$41.00	FRETWORK GRID	\$35.95	GRID BLOCKS	\$37.10
DISCO LINES	\$25.95	EDWINA	\$32.35	FRETWORK STRIE	\$20.00	GRID FRAME	\$22.00
DISEGNO	\$27.15	EIDELMAN	\$30.30	FRITCH	\$15.95	GRID SQUARED	\$13.95
DOGGA	\$21.95	ELECTRIC WAVE	\$86.00	FULL CIRCLE	\$30.30	GRIDDED MAZE	\$15.95
DOGGA STRIPE	\$23.00	ELECTRIFY	\$22.45	FULL GRAIN	\$19.95	GUARDRAIL	\$35.00
DOLCE VITA	\$102.00	ELEGANT SUZANI	\$36.00	FULL KEEL	\$50.05	GUEST LIST	\$41.95
DONARIA	\$33.95	ELEMENTARY	\$22.95	FUTURA GRID	\$63.95	GUIDELINES	\$41.95
DONGARY	\$22.00	ELKANAH	\$15.95	GALAXY SPIRAL	\$22.00	GULF STREAM	\$49.60
DORCHESTER	\$15.75	EMBASSY ROW	\$29.80	GALLOWS	\$42.75	GYPSY BANDS	\$39.00
DOTS GALORE	\$25.95	ENGRAVING	\$9.95	GALWAY	\$41.00	HAIL STONES	\$21.00
DOTS N RIBBONS	\$23.95	ENLIGHTEN	\$34.00	GAME CHANGER	\$88.00	HAMMER STRIPE	\$26.00
DOTTED ECLIPSE	\$55.95	EON	\$24.00	GAME PIECE	\$22.00	HAMMOCK TIME	\$34.45
DOTTED FRAME	\$44.95	EQUAL ROWS	\$15.95	GARDEN SPRAY	\$29.95	HAMPTON COURT	\$20.00
DOTTED LINES	\$25.95	EVENING SCROLL	\$30.30	GARDEN WALK	\$28.95	HAND TAILORED	\$93.95
DOTTED LOOPS	\$39.95	EXAM	\$38.15	GATHERING	\$29.25	HATTORI	\$35.50
DOTTED PAISLEY	\$15.95	EXPOSED	\$25.10	GEM TEXTURE	\$22.00	HAZY STRIPES	\$32.35
DOTTED ROW	\$28.95	EXPRESS LANE	\$26.95	GEMSTONE	\$39.65	HEADSAIL	\$39.65
DOTTED SCRIPT	\$28.95	EXQUISITE	\$55.95	GENTLE DREAM	\$23.00	HELIX WONDER	\$35.95
DOTTED WAY	\$17.00	EXTRA MILE	\$34.95	GEOMETRIC WAY	\$20.95	HEXAGON	\$28.95
DOTTY LEAF	\$39.00	EYE CANDY	\$29.25	GEOMETRY	\$35.95	HEXAGON LINKS	\$38.95
DOUBLE LOOK	\$29.00	FADING FOLIAGE	\$26.95	GERHARD	\$51.95	HEXAGON RIB	\$35.00
DOUBLE SCROLL	\$31.95	FALLEN DOMINOS	\$33.40	GIANNI	\$44.00	HEXLEY	\$4.50
DOUBLE ZIPLINE	\$55.00	FAMILY CREST	\$15.95	GILA MOUNTAIN	\$15.95	HIGH TEA	\$30.30
DRAWBRIDGE	\$28.50	FANCY STITCH	\$34.45	GILLIGAN	\$15.95	HIGH WAVES	\$33.40
DRAWN OUT	\$35.00	FAR OUT	\$61.00	GINGRASS	\$12.95	HILLSTEAD	\$29.95
DRESS ME UP	\$23.00	FAST LANE	\$32.35	GISELE	\$39.00	HODGEPEDGE	\$31.35

WHOLESALE TRADE PRICE LIST
800.333.3778

ROBERT ALLEN accepts MasterCard, Visa® and American Express

ROBERT ALLEN CONTRACT

PATTERN	PIECE PRICE	PATTERN	PIECE PRICE	PATTERN	PIECE PRICE	PATTERN	PIECE PRICE
HOLLY BROOK	\$12.95	KINGS ROAD	\$30.30	LOOPY SHEER	\$20.00	MIXOLOGY	\$30.00
HOMEPORT	\$30.30	KINGSCOTE	\$30.30	LORING PARK	\$38.95	MOCK CROC	\$26.00
HOP ON	\$25.00	KINGSCROSS	\$31.35	LOUISBURG	\$32.35	MODERN ARCH	\$29.00
HOPSACK	\$22.95	KINGSTON SHORE	\$22.00	LUMIERE	\$48.95	MODERN BLINDS	\$63.00
HORNELL	\$20.45	KIVITEL	\$34.45	LUREX DIAMONDS	\$40.95	MODERN BRAID	\$41.00
HOSHI	\$11.45	KLAUSON	\$29.25	LUSTER MESH	\$18.00	MODERN CORAL	\$38.95
HOWAYEK	\$27.95	KNIGHTSBRIDGE	\$27.75	LUSTROUS ROWS	\$18.00	MODERN CORD	\$35.95
HUNTINGTON AVE	\$20.00	KNITTLES	\$44.85	LUXE LARIAT	\$27.15	MODERN CURVE	\$44.00
IDEAL MIX	\$27.15	KUDZO	\$36.55	LUXE LOOK	\$34.00	MODERN MELTON	\$42.00
IKAT SATIN	\$32.95	LA CIVITA	\$43.80	LUXURIOUS LOOK	\$19.95	MODERN OVALS	\$38.00
IKAT SQUARES	\$43.95	LA FANU	\$11.95	LUXURY DUPIONI	\$12.95	MODERN PUZZLE	\$41.95
IKAT STRIPE BK	\$9.95	LAIRD	\$28.20	MACARIA	\$30.30	MODERN SHAPES	\$19.95
IMITABLE	\$24.00	LANDMARK	\$32.35	MADISON DAMASK	\$36.05	MODERN TRACERY	\$38.95
IMPALA	\$39.20	LAPORTA	\$40.00	MAGNETO	\$39.00	MODERN TRELIS	\$25.95
IN HER SHOES	\$39.00	LASER LATTICE	\$39.95	MAMMOTH STAR	\$29.95	MODERN VINE	\$34.00
IN LINE	\$24.60	LATEST LOOK	\$42.00	MANSFORD	\$12.95	MODEST PLUSH	\$32.95
IN THE GROOVE	\$72.00	LATTICE BAMBBK	\$9.95	MANVEL	\$15.95	MONTANE	\$32.95
IN TRANSIT	\$35.00	LAVISH STRIPES	\$35.95	MARCO ISLAND	\$30.95	MOON BEACH	\$32.35
INABA	\$33.00	LAWN CHAIR	\$44.00	MARINA DOT	\$45.00	MOON DANCE	\$15.95
INESCAPABLE	\$32.95	LE MISTRAL	\$28.20	MASSEY	\$36.05	MOORISH PAVER	\$122.00
INFUSER	\$43.95	LEADING EDGE	\$26.15	MATCH SET	\$15.95	MOORS VALLEY	\$26.15
INNER CIRCLE	\$36.00	LEAF LINE	\$37.95	MATISSE FLORAL	\$30.95	MORNING CIRCLE	\$19.95
INTEGRITY	\$39.65	LEAF NOUVEAU	\$15.95	MATRIX	\$28.20	MOROCCAN TILE	\$56.00
INTERCHANGE	\$95.95	LEAF PILE	\$32.35	MATTE SHIMMER	\$17.00	MOZAIC FUN	\$34.95
INTERIOR LOOP	\$35.95	LEAF SKETCHES	\$17.35	MAXIXE	\$29.00	MULHOLLAND DR	\$41.00
INTERLOCK	\$45.95	LEAF SPIRALS	\$33.40	MAYLEA GARDEN	\$28.20	MULTI TRACK	\$28.20
INTOXICATING	\$39.65	LEAF STRIE	\$28.95	MAZE SOLID	\$23.95	MYAKI	\$19.95
INTUITION	\$29.25	LEAFY CABANA	\$34.45	MCALOON	\$34.00	MYSTERY NET	\$86.00
ISLAND STRIPE	\$23.05	LEAVITT	\$32.95	MEADMORE	\$40.95	NAIYA STRIPE	\$25.95
ISOLA PRIVATA	\$94.95	LECREOLE	\$29.00	MEADOW GARDEN	\$11.95	NARROW ROADS	\$38.95
ISOSCELES	\$36.00	LEDGER	\$31.35	MEAH	\$18.95	NASSAU BAY	\$26.00
ITS MY LINE	\$32.35	LEITRIM	\$29.25	MEDIALUNA	\$38.00	NATCHEZ TRACE	\$15.95
IVORY COAST	\$39.00	LEOPARD FLOCK	\$23.95	MELANGE STRIPE	\$32.95	NATURAL MUSKET	\$18.40
IVY ISLE	\$54.20	LEOTI	\$37.10	MELANGE TWEED	\$35.00	NAUGHTY NET	\$13.20
JAGGED EDGE	\$15.95	LIBERTY LANE	\$41.00	MENDOCINO	\$32.35	NAUTICAL MILE	\$39.65
JAM SESSION	\$39.00	LIFESAVER	\$29.25	MERLANA	\$18.10	NELSON TEXTURE	\$12.00
JAMAICA	\$16.75	LIFTED LINES	\$41.00	METAL LUSTRE	\$20.95	NESTING CUBES	\$20.45
JAMESPORT	\$32.35	LIFTOFF	\$35.00	METAL LUXE	\$36.00	NEW CLASSIC	\$19.95
JAYA	\$23.05	LINDEN PARK	\$15.95	METAL WEAVE	\$39.95	NEW CONTOURS	\$38.95
JAZZ AGE	\$56.00	LINDY HOP	\$31.00	METAPHYSICAL	\$30.95	NEW DAMASK BK	\$9.95
JET SET	\$39.95	LINE STITCH	\$28.95	METATRON	\$25.10	NEW DAWN	\$29.80
JITTERBUG	\$53.95	LINEAL LANES	\$12.00	METEORS	\$15.95	NEW DIMENSION	\$22.00
JOJO LINE	\$45.00	LINEAR TEXTURE	\$33.00	METRICS	\$22.45	NEW FRONTIER	\$49.00
JUMP DRIVE	\$31.35	LINED ROAD	\$21.00	MIGG VELVET	\$38.95	NEW LOOK	\$17.95
JUMPING JACKS	\$41.00	LINED UP	\$45.00	MIKER	\$35.00	NEW SENSATION	\$28.80
JUNGLE LAND	\$31.00	LINEN IMAGE	\$12.95	MILBURY	\$32.95	NEW TEXTURE	\$24.95
KAI	\$38.15	LINKAGE	\$33.95	MILLCREEK	\$32.35	NICE N NEAT	\$21.95
KALAMKARI	\$27.95	LINKED SHAPES	\$29.00	MINI BOXES	\$30.30	NIGHT STAR	\$35.00
KARELIS	\$31.00	LISBETH FLORAL	\$38.15	MINI CHECK	\$4.50	NO PHOTOS PLS	\$31.95
KATONAH	\$40.00	LITTLE ROCK	\$27.95	MINI HONEYCOMB	\$54.95	NONSTOP	\$15.95
KEA	\$26.95	LIZA	\$25.65	MINI VINE	\$31.35	NORTH STREET	\$30.95
KEEP MOVIN	\$34.45	LOCOMOTION	\$28.20	MINIMALIST	\$29.25	NUBUCKSTON	\$25.00
KEIKO GARDEN	\$35.50	LONDON EYE	\$15.95	MIRROR DIAMOND	\$42.95	NYUMBA	\$38.60
KELMSCOTT	\$25.95	LONG RANGE	\$16.00	MIRROR EFFECT	\$35.00	OCEAN DRIVE	\$31.35
KENDALL SQUARE	\$20.00	LONG ROWS	\$18.95	MISSION SHAKER	\$29.95	OCEAN LINER	\$46.45
KEY CORA	\$23.00	LOOK BACK	\$15.95	MISSION TWEED	\$15.95	OCEAN PLAID	\$32.35
KICKAPOO	\$29.25	LOOKING GLASS	\$31.35	MIX AND MATCH	\$25.95	OCEAN STRIPE	\$36.05
KILROY	\$57.95	LOOP SCROLL	\$15.95	MIX IT UP	\$26.70	OCTAVE	\$26.70

WHOLESALE TRADE PRICE LIST
800.333.3778

ROBERT ALLEN accepts MasterCard, Visa® and American Express

ROBERT ALLEN CONTRACT

PATTERN	PIECE PRICE	PATTERN	PIECE PRICE	PATTERN	PIECE PRICE	PATTERN	PIECE PRICE
OFFBEAT	\$26.95	PLAID PALMS	\$29.25	RING THROUGH	\$15.95	SENSIBILITY	\$22.95
OH DEAR	\$42.00	PLAIN ELEGANCE	\$6.95	RINGLEADER	\$45.00	SHADOW LEAF	\$23.95
OKAPI	\$18.00	PLAINVIEW	\$24.95	RINGO	\$31.35	SHADOW MIX	\$26.70
OLENSKA	\$34.00	PLATFORM	\$58.95	RINOMATO	\$45.00	SHAINA	\$31.00
OLMSTEAD	\$37.10	PLAY BACK	\$29.25	RIVER PARK	\$34.95	SHEDAISY	\$39.65
OMBRE FLEUR	\$15.95	PLAZA DAMASK	\$29.25	RIVERS BEND	\$29.00	SHEER ENERGY	\$15.75
OMBRE FRAME	\$15.95	PLEAT SOUND	\$34.00	RIVERTRAIL	\$15.95	SHEER GLORY	\$20.45
OMBRE VIEW	\$24.00	PLEATED STRIPE	\$36.95	RIVINGTON	\$28.95	SHEER MADNESS	\$21.00
ON DECK	\$41.75	PLUSH STAR	\$54.00	ROBINETTE	\$31.95	SHELLAC	\$26.00
ON THE ROCKS	\$71.00	PLUSH STRIE	\$31.00	ROCKSTAR	\$55.95	SHETLAND LINE	\$9.95
ON THE RUN	\$36.55	POLO BEACH	\$31.95	ROCKY PLAIN	\$30.95	SHIMADZU	\$20.45
ON THE SPOT	\$26.70	POMERANCE	\$32.35	ROIATTI	\$27.15	SHIMMER SOLID	\$22.00
OPEN LINES	\$18.00	POMPTON	\$25.95	ROMAN VINE	\$33.40	SHINE BRIGHTLY	\$31.95
OPEN SPACES	\$29.95	POP PAISLEY	\$27.15	RONA	\$26.70	SHINE THROUGH	\$46.00
OPTIC MOVES	\$29.00	PORT OF CALL	\$35.00	ROOFTOP REVERY	\$56.00	SHINY MEADOW	\$20.95
OPTIC WAVE	\$36.05	PORTOFINO	\$22.00	ROSHEEN	\$30.30	SHINY PAISLEY	\$20.95
OPTICAL FACET	\$15.95	POSH PLEAT	\$30.00	ROUNDAABOUT	\$15.95	SHOREWOOD	\$31.35
OPTICAL NET	\$21.45	POWER GRID	\$18.00	ROW BY ROW	\$25.10	SHOW OFF	\$34.00
ORATOR	\$41.25	PRETTY VIEW	\$39.00	ROWENA DOT	\$15.95	SHUBELIC	\$15.95
OUR GENERATION	\$29.25	PRIMERA	\$15.95	ROYAL CITY	\$29.95	SHUFFLE ALONG	\$45.00
OUT AND ABOUT	\$30.00	PRINCE EDWARD	\$19.00	ROYAL MIX	\$33.95	SIDEWINDER	\$43.95
OUT AND ABOUT	\$36.00	PROPORTION	\$22.00	RUBINA	\$30.00	SILVER FUSION	\$25.95
OUT OF THE BOX	\$24.95	PUCKER DOT	\$40.95	RUNNING LINES	\$38.00	SILVER LINING	\$30.00
OUTLOOK	\$15.95	PUNDANT	\$38.15	RUNNING REEF	\$46.95	SIMPLE COMFORT	\$18.95
PACHINKO	\$27.75	PURE DECOR	\$33.00	RUSH HOUR	\$29.25	SIMPLE CURVE	\$32.00
PADDINGTON	\$15.95	PUZZLE	\$38.15	RUSTIC SCENE	\$14.00	SIMPLE LINES	\$30.30
PAINT SPRAY	\$33.95	PUZZLE SHAPES	\$45.00	SADDLE STITCH	\$38.95	SIMPLE RUFFLE	\$32.00
PAISLEY LAGOON	\$34.45	PYRAMID CLUB	\$49.95	SAGITTAL	\$25.95	SIMPLE STITCH	\$47.00
PAISLEY TOSS	\$41.95	QUAD	\$43.95	SALVE REGINA	\$41.00	SIMPLE TEXTURE	\$15.95
PALACE STRIPE	\$28.20	QUESTION	\$41.75	SANDS POINT	\$27.95	SIMPLY CHIC	\$12.95
PALISADAS	\$75.00	QUIZ	\$41.75	SANTERNO	\$16.00	SIMPLY VELVET	\$38.95
PALM BAY	\$30.30	RACEWAY	\$24.00	SASSY CURVE	\$39.00	SINGLE FILE	\$26.95
PALMESE	\$36.95	RACING STRIPE	\$28.20	SATIN PAISLEY	\$35.95	SIXPENCE	\$26.70
PANTEGO	\$15.95	RAILROAD TRACK	\$31.00	SATIN PLAIN	\$17.35	SKETCHED VINES	\$39.00
PARAMETER	\$46.50	RAIN STORM	\$33.40	SATIN SCROLL	\$36.95	SKIN SCENE	\$55.00
PARFAY	\$19.00	RANA	\$25.95	SATIN TREAD	\$28.00	SKYLIGHT	\$30.30
PARK DRIVE	\$24.60	RATHFARNHAM	\$20.95	SATIN TRELLIS	\$35.95	SLING BACK	\$32.35
PARSONS WOODS	\$40.00	RAY OF LIGHT	\$23.95	SATISFACTION	\$23.55	SLITHER	\$34.95
PASTICHE	\$25.95	RAZIEL	\$23.55	SAVANNAH WAY	\$45.00	SLITHER	\$38.00
PATENTED	\$36.00	RECONSIDER	\$32.95	SAVILE ROW	\$20.40	SMALL OGEE	\$24.95
PATIOLOUNGE	\$47.50	REFERENCE	\$29.95	SAVING GRACE	\$32.95	SMIRK	\$32.00
PAUSE	\$25.95	REFINED GRID	\$20.00	SCALLOP STRIPE	\$31.95	SMOOTH SAILING	\$34.45
PAVATI	\$20.40	REFINED STRIPE	\$14.45	SCANDO VINE	\$31.95	SMOOTH SOLID	\$19.95
PEBBLE STITCH	\$20.00	REGIMENT	\$9.95	SCAPEGOAT	\$25.95	SMOOTH STRIPE	\$19.95
PEMBRIDGE	\$37.55	RELAXED HUES	\$15.95	SCOTTIA	\$30.95	SOFT CHENILLE	\$38.15
PENCE II	\$13.20	REMBOLD	\$37.95	SCRIBBLE PAD	\$33.95	SOFT HAND	\$6.95
PENTA	\$15.95	RETRO BUBBLE	\$30.30	SCRIBED ART	\$33.95	SOFT KEYS	\$21.00
PENTUCKET	\$15.95	RETRO FASHION	\$22.95	SCROLLED LINKS	\$32.95	SOFT N DANDY	\$23.95
PERFECT IKAT	\$32.35	RETRO GEO	\$43.35	SCROLLING LEAF	\$35.50	SOFT NET	\$15.00
PERFECTA	\$39.65	RETRO MOVE	\$24.00	SEA DREAM	\$43.80	SOFT PALLET	\$15.95
PERSUASION	\$37.00	REVERBERANT	\$24.50	SEA RIDGE	\$27.75	SOFT ROADS	\$46.25
PILLOWTALK	\$35.50	REVOLVE	\$15.95	SEBELIUS	\$30.00	SOFTENED SOLID	\$60.00
PIMA POINT	\$44.00	RIB WAVE	\$15.95	SECOND LOOK	\$33.00	SOLID JAMMIN	\$34.45
PIN WHEEL	\$30.95	RIBBON EFFECT	\$63.95	SECOND TIME	\$27.95	SOLID SHINE	\$19.95
PINCEAUX	\$44.95	RIBBON SHIMMER	\$18.00	SECRET PASSAGE	\$77.00	SOLID STITCH	\$29.95
PINCKNEY	\$32.35	RIBBON TWIST	\$40.95	SEIZMIC	\$15.95	SOLID WEAVE	\$15.00
PIXEL	\$41.95	RIBBONTROP	\$19.95	SELWYN	\$15.95	SONIC BOOM	\$24.95
PLAID MANIA	\$23.95	RICO	\$22.00	SEMIDO	\$20.45	SONIC RIPPLE	\$28.95

WHOLESALE TRADE PRICE LIST
800.333.3778

ROBERT ALLEN accepts MasterCard, Visa® and American Express

ROBERT ALLEN CONTRACT

PATTERN	PIECE PRICE	PATTERN	PIECE PRICE	PATTERN	PIECE PRICE	PATTERN	PIECE PRICE
SOUTH COAST	\$15.95	SUNSET STRIP	\$34.00	TUCKED FRAME	\$39.00	WHIMSY CIRCLE B	\$9.95
SPACED LINES	\$15.95	SUNSPOT	\$54.95	TUCKED FRAME	\$38.00	WHISPER SOFT	\$15.75
SPECKLED DOTS	\$29.25	SUPER STAR	\$15.95	TUDOR COURT	\$38.95	WHISPER WOOD	\$28.95
SPECKLED LANE	\$18.00	SURFS UP	\$31.35	TULIKA STRIPE	\$34.45	WHITEBRIDGE	\$32.35
SPHERICAL	\$32.35	SURMELIS	\$31.00	TURTLE SHELL	\$31.95	WIDE RIBBONS	\$9.95
SPICE MARKET	\$127.00	SWAYING VINE	\$15.95	TWINING LEAVES	\$33.40	WILD CIRCLES	\$37.55
SPIDER WEB	\$26.70	SWEET CAROLINE	\$29.25	TWIST AND TURN	\$20.00	WILD GARDEN	\$26.95
SPIRAL CENTER	\$38.95	SWEETGRASS	\$37.55	TWISTED TOFFEE	\$25.50	WILD RICE	\$33.40
SPLASH	\$29.00	SWIRLED CURVES	\$35.50	TWO STEP	\$30.85	WIND CHIME	\$36.55
SPLIT TRIANGLE	\$31.35	SWISS RANGE	\$15.95	UNAGI	\$36.00	WINDING UP	\$36.00
SPRING DEW	\$15.00	SWOOPS	\$15.95	UNCHAIN	\$35.00	WINDSCAPE	\$42.95
SPRING FEST	\$34.00	SYMMETRICAL	\$29.25	UNDERBRUSH	\$35.50	WINNING CHOICE	\$40.00
SPRING FEVER	\$46.45	SYNCOPATION	\$32.00	UNDERSTATED	\$28.20	WOODVILLE	\$7.95
SPRING RAIN	\$30.00	TABLOID	\$32.35	UNDULATION	\$30.00	WOODWAY	\$30.95
SPRING WALK	\$33.00	TABOO	\$9.95	UNIQUE LINES	\$8.45	WOOL VELVET	\$45.95
SPRITZ	\$35.95	TAILORED LINES	\$20.00	UNIQUE TEXTURE	\$15.95	WORLD CLIQUE	\$23.95
SQUARE CIRCLES	\$33.95	TALKING POINT	\$39.65	UNTIL DAWN	\$55.00	WOVEN SHIMMER	\$21.95
SQUARE CONCEPT	\$40.95	TAM TAM	\$76.00	UNWRITTEN	\$35.00	WYOMING	\$20.95
SQUARE TEXTURE	\$15.00	TANGLED PATH	\$15.95	UPGRADE	\$48.00	YARN ORBITS	\$20.95
SQUARED COLOR	\$28.95	TANGLES	\$36.00	UPTOWN TWEED	\$39.00	YUMIKO	\$20.40
SQUARED LEAF	\$39.00	TAPANI	\$4.50	URBAN CHIC	\$36.95	ZANTHURA	\$29.25
SQUARED UP	\$15.95	TAYLORMADE	\$13.95	VACATION PLUSH	\$55.25	ZANY LANES	\$10.95
SQUIGGLE IT	\$25.95	TECH LINES	\$27.95	VALLEY SUITES	\$35.50	ZEBRA SAFARI	\$45.00
SQUIGGLE LINES	\$28.00	TECHNO FASHION	\$37.00	VAMP	\$26.00	ZIGGY POP	\$38.95
ST ANDREWS	\$32.35	TEKENING	\$29.25	VAPOR CAPER	\$95.00	ZIGGY WAVES	\$44.00
ST TROPEZ	\$24.95	TERRAZZA	\$53.95	VEILED	\$52.95	ZIGZAG DIAMOND	\$15.95
STANDBY	\$26.00	TEXTURE CHECK	\$30.00	VELVET HIDCOTE	\$38.95	ZOOM	\$38.95
STAR APPEAL	\$32.35	TEXTURE PATH	\$35.00	VELVET ROPE	\$58.95	ZOTZ	\$33.40
STAR MAPS	\$54.00	TEXTURE SCREEN	\$61.00	VIA VENETA	\$21.00	ZOU ZOU	\$29.00
STAR SIGHTING	\$75.00	TEXTURE SHAPE	\$36.00	VIBRANT STRIPE	\$29.95		
STATE ROOM	\$37.10	TEXTURED ORB	\$35.95	VINE SHIFTER	\$30.30		
STAY CONNECTED	\$29.00	THATCHED	\$21.00	VINE STITCH	\$40.55		
STELLAR LIGHT	\$31.35	THE ELMS	\$30.30	VINETTA	\$6.35		
STENCILED BEAM	\$37.00	THREAD BARE	\$15.25	VINTAGE MODERN	\$26.95		
STEP TRELIS	\$24.95	THURSTON	\$35.95	VIP	\$95.95		
STILL LEAVES	\$32.35	TIKAL	\$30.30	VIPER CLUB	\$71.00		
STITCH EFFECT	\$20.00	TIKI TORCH	\$30.95	VISBY	\$35.95		
STITCHED BOXES	\$23.95	TILED	\$34.95	VIVIDLY	\$25.95		
STONE EFFECT	\$28.00	TIP TOP	\$38.95	WAFFLE BOUCLE	\$32.95		
STONE FRAGMENT	\$42.00	TOKEN	\$32.00	WAITSFIELD	\$29.80		
STONE LUXE	\$28.00	TOP DRAWER	\$34.95	WALK ABOUT	\$26.15		
STONYBROOK	\$22.00	TOPNOTCH	\$37.55	WALKING MAZE	\$15.95		
STRAIGHT AHEAD	\$32.50	TOWNLINE	\$30.95	WALKING PATH	\$23.00		
STRAIGHT LINE	\$26.95	TRADEWINDS	\$49.60	WALL STREET	\$43.95		
STRATHAM	\$29.95	TRAIL MAZE	\$46.40	WALLFLOWER	\$25.65		
STREAMING	\$21.95	TRANSOM	\$49.95	WARM PLAID	\$38.95		
STRIE FLEUR	\$20.00	TREE LEAVES	\$26.95	WARM SWEATER	\$14.95		
STRIKE A POSY	\$27.15	TREE OF LIFE	\$36.00	WARMER DAYS	\$13.20		
STRING GAMES	\$30.00	TRELLIS WORK	\$32.35	WATCHER	\$42.00		
STROME	\$4.50	TRIANGLE GRID	\$31.00	WATERLINE	\$54.20		
SUBTLY MODERN	\$25.95	TRIANGULATION	\$44.95	WATERLOO	\$29.25		
SUMI	\$32.35	TRIBAL CHANCE	\$27.95	WATERPLACE	\$24.95		
SUMMATION	\$44.95	TRINITY	\$41.00	WEAVE MODE	\$26.15		
SUMMER HEAT	\$32.00	TRISSEL	\$32.00	WEAVE ROAD	\$14.95		
SUNBURST	\$27.75	TROPICAL GEMS	\$23.05	WEAVING LOOPS	\$38.95		
SUNBURST COURT	\$15.95	TROPICAL LEAF	\$29.25	WEB WORK	\$22.45		
SUNSET CIRCLE	\$32.00	TROPICAL OASIS	\$31.95	WEBTASTIC	\$49.00		
SUNSET GRILL	\$35.00	TUAM	\$29.25	WESTBOURNE	\$23.05		

WHOLESALE TRADE PRICE LIST
800.333.3778

ROBERT ALLEN accepts MasterCard, Visa® and American Express

SPECIAL FABRIC FINISHES

STAIN REPELLENT

1-30 yards.....\$1.25/yd
31 yards and over.....\$1.10/yd

Stain repellent can be applied to upholstery fabric, at the time of flame proofing, for an additional charge of \$2.00/yd. All special fabric finish orders must be in full yard increments.

Nano-*Tex*[®] + Durablock[®]

Fabrics finished with Nano-*Tex*[®] + Durablock[®] offer permanent spill and stain resistance with a breathable moisture barrier. Our unique molecular formula imparts permanent performance characteristics designed to attach to each fiber, thus maintaining the original feel of the fabric and never losing breathability.

Fabrics finished with Nano-*Tex*[®] offer permanent spill and stain resistance without sacrificing a natural hand.

Nano-*Tex*[®] + Durablock[®]

5-9 yards.....	\$30.00/yd	20-24 yards.....	\$8.00/yd
10-14 yards.....	\$15.00/yd	25-49 yards.....	\$6.25/yd
15-19 yards.....	\$10.00/yd	50 yards & over.	\$5.50/yd

Nano-*Tex*[®]

5-19 yards.....	Minimum Charge \$150.00
20-49 yards.....	\$4.00/yd
50 yards & over	\$2.75/yd

FLAMEPROOFING (FR)

Drapery.....	\$1.75/yd
Upholstery	\$2.50/yd
118" Sheers	\$3.50/yd
Trims.....	\$2.50/yd
FAA Regulation.....	\$14.75/yd

(Please note, we do not test or certify for Class A)

LAMINATING

An additional yard is required for this process

Matte Vinyl Laminate

5-29 yards.....	Minimum Charge \$179.95
30 yards and over.....	\$8.85/yd

BACKING

Acrylic Backing or Flame Retardant Acrylic Backing
(Upholstery).....\$2.50/yd

Cotton Knit Backing

5-29 yards.....	Minimum Charge \$179.95
30 yards and over.....	\$8.85/yd

ROBERT ALLEN

INDEX

Showrooms	8-9
Fabrics	10-33
Fabric Care	34
Special Fabric Finishes	35
Trim	36-38
Decorative Drapery Hardware	39-60
Current Books	61-62
Terms & Conditions	63

Note: In the interest of customer choice, we are no longer automatically applying chemical stain repellents on our fabrics. If a stain repellent finish is desired, Teflon is available as an option (see Special Fabric Finishes).

SHOWROOMS

ALABAMA

MET Design Center
3005 3rd Avenue South
Birmingham, AL 35233
T 205.322.5497
F 205.322.5435

ARIZONA

Pacific Resource Group
2732 N. 68th Street, Suite # 1
Scottsdale, AZ 85257
T 480.905.6953
F 480.905.0022

CALIFORNIA

Gina B & Company
23811 Aliso Creek Road, Suite # 136
Laguna Niguel, CA 92677
T 949.643.1430
F 949.643.9457

Pacific Design Center
8687 Melrose Avenue, Suite # B499
Los Angeles, CA 90069
T 310.659.6454
F 310.659.9548

Egg & Dart, Ltd.
74-050 Highway 111
Palm Desert, CA 92260
T 760.340.3900
F 760.340.3991

Designers Only
8440 Belvedere Avenue, Suite # 8
Sacramento, CA 95826
T 916.457.5505
F 916.457.5577

Harsey & Harsey
4090 Morena Boulevard, Suite A
San Diego, CA 92117
T 858.274.4481
F 858.274.4485

San Francisco Design Center
101 Henry Adams Street
Galleria Suite # 426
San Francisco, CA 94103
T 415.864.4822
F 415.864.5561

Design Mart Silicon Valley
23 Las Colinas Lane, Suite # 104
San Jose, CA 95119
T 408.229.6500
F 408.229.0400

COLORADO

MODA Antica
595 S. Broadway, Suite # 118 W
Denver, CO 80209
T 303.733.9003
F 303.733.1077

CONNECTICUT

DesignSourceCT
1429 Park Street, Suite # 100
Hartford, CT 06106
T 860.951.3145
F 860.951.3144

DISTRICT OF COLUMBIA

Washington Design Center
1099 14th Street NW Suite # 410
Washington, DC 20005
T 202.863.0404
F 202.863.0426

FLORIDA

Designer Resource Center
1141 S. Rogers Circle, Suite # 4
Boca Raton, FL 33487
T 561.997.0040
F 561.997.6911

Scalamandre
2868 Pershing Street
Hollywood, FL 33020
T 954.920.2244
F 954.920.5662

Interiors Trading Co. of Jacksonville
8940 Western Way, Suite # 15
Jacksonville, FL 32256
T 904.464.0100
F 904.464.0700

International Design Source
6001 Taylor Road
Naples, FL 34109
T 239.598.4827
F 239.591.4297

Interiors Trading Co. of Orlando
408 Virginia Drive
Orlando, FL 32803
T 407.228.9966
F 407.228.9977

Interiors Trading Company, Inc.
315 N. Willow Street
Tampa, FL 33606
T 813.258.6678
F 813.258.6738

Jack Walsh Carpets and Rugs
501 Ardmore Road
West Palm Beach, FL 33401
T 561.659.4846
F 561.659.0968

GEORGIA

Atlanta Decorative Arts Center
351 Peachtree Hills Avenue NE, Suite # 401
Atlanta, GA 30305
T 404.266.0015
F 404.266.0855

ILLINOIS

Chicago Design Team, Ltd.
3425 N. Ridge, Unit B
Arlington Heights, IL 60004
T 847.394.1800
F 847.394.1886

Merchandise Mart
222 Merchandise Mart, Suite # 633
Chicago, IL 60654
T 312.644.5790
F 312.644.7481

INDIANA

The Trade Source
200 South Rangeline Road, Suite # 226
Carmel, IN 46032
T 317.818.8250
F 317.818.8254

KANSAS

KDR Designer Showrooms/ Kansas City
8510 Marshall Drive
Lenexa, KS 66214
T 913.859.0400
F 913.859.0483

MARYLAND

Peyton Home
11409 Cronhill Drive, Suite G
Owings Mills, MD 21117
T 410.998.9424
F 443.681.7135

MASSACHUSETTS

Boston Design Center
One Design Center Place, Suite # 200
Boston, MA 02210
T 617.482.6600
F 617.348.4297

MICHIGAN

Michigan Design Center
1700 Stutz Drive, Suite # 28
Troy, MI 48084
T 248.643.0707
F 248.643.8424

MINNESOTA

Hoffsommer et Cie
275 Market Street, Suite # 262
Minneapolis, MN 55405
T 612.375.0046
F 612.375.0048

MISSOURI

KDR Designer Showrooms
11660 Page Service Drive
St. Louis, MO 63146
T 314.993.5020
F 314.993.6551

NEBRASKA

Josin Designer Showroom
4511 S. 133rd Street
Omaha, NE 68137
T 402.393.5677
F 402.393.0864

NEVADA

Elan Collections
7711 W. Post Road
Las Vegas, NV 89113
T 702.255.8267
F 702.242.9436

NEW YORK

D & D Building
979 Third Avenue, 3rd Floor
New York, NY 10022
T 212.421.1200
F 212.421.0554

Woodbury Showroom
220 Crossways Park Drive West
Woodbury, NY 11797
T 516.677.9160
F 516.364.5168

NEW JERSEY

White House Design Resource
131 Route 46 West
Fairfield, NJ 07004
T 973.575.1331
F 973.575.0840

NORTH CAROLINA

A. Hoke Ltd.
725 S. Cedar Street
Charlotte, NC 28202
T 704.358.0277
F 704.358.1708

A. Hoke Ltd.
1405 Capital Boulevard
Raleigh, NC 27603
T 919.832.5555
F 919.832.5514

OHIO

Gregory Alonso, Inc.
23533 Mercantile Road, Suite # 113
Beachwood, OH 44122
T 216.765.1810
F 216.765-1858

Singer Showroom
700 W. Pete Rose Way
Cincinnati, OH 45203
T 513.621.3081
F 513.621.3084

Ruth Wilson Showroom
815 Grandview Avenue, Suite # 500
Columbus, OH 43215
T 614.421.3070
F 614.421.3075

OKLAHOMA

Design Concepts
7700 N. Hudson, Suite # 3
Oklahoma City, OK 73116
T 405.843.6304
F 405.843.6302

OREGON

NEST Showroom
2151 NW Front Ave.
Portland, OR 97209
T 971.544.7727
F 866.419.4604

PENNSYLVANIA

Marketplace Design Center
130 S. Juniper Street, Suite # 102
Philadelphia, PA 19107
T 215.567.1155
F 215.567.3571

Willow Grove Showroom
484 Lowries Run Road
Pittsburgh, PA 15237
T 412.366.4133
F 412.366.6133

TENNESSEE

Manoirs
718 Melrose Avenue
Nashville, TN 37211
T 615.291.9901
F 615.291.9902

TEXAS

Stockton Hicks Laffey
7301 Burnet Road, Suite # 200
Austin, TX 78757
T 512.302.1116
F 512.302.1213

Dallas Design District
1025 N. Stemmons Freeway, Suite # 747
Dallas, TX 75207
T 214.741.5454
F 214.741.0105

Decorative Center of Houston
5120 Woodway, Suite # 141
Houston, TX 77056
T 713.439.0200
F 713.439.0137

Interior Trade Cartel
930 Proton, Suite # 303
San Antonio, TX 78258
T 210.494.1602
F 210.494.1603

UTAH

CCG Howells
358 South Rio Grande, Suite # 100
Salt Lake City, UT 84101
T 801.359.6622
F 801.359.6636

VIRGINIA

Designer's Market of Richmond, Inc.
2107B North Hamilton Street
Richmond, VA 23230
T 804.353.5224
F 804.353.5161

WASHINGTON

The Dixon Group
5701 6th Avenue South
Seattle, WA 98108
T 206.767.4454
F 209.763.5700

WISCONSIN

Brook Park Design Center
21950 Watertown Road, Unit A
Waukesha, WI 53186
T 262.784.8030
F 262.784.8094

CANADA

Toronto Showroom
170 Bedford Road
Toronto, Ontario M5R 2K9
T 647.699.8271
F 647.699.8279

Vancouver Showroom
430 Railroad Street, Unit 260
Vancouver, B.C. V6A 1B1
T 604.255.0010
F 604.255.4121

Variations For Designers
4269 Rue St. Catherine Ouest, Suite # 400
Montreal, PQ H3Z 1P7
T 514.938.2677
F 514.938.2663

UK

Design Centre
Chelsea Harbour
London SW10 0XE
T 44 (0) 20 7352 0931
F 44 (0) 20 7352 0935

ROBERT ALLEN

PATTERN	PRICE	PATTERN	PRICE	PATTERN	PRICE	PATTERN	PRICE	PATTERN	PRICE
1.5 DIAMOND QLT	\$188.00	ADELRAY	\$94.00	ALCHEMY LEATHER	\$20.00	AMAZING GRACE	\$68.00	ANTHEM	\$28.97
1.5 SQUARE QLT	\$188.00	ADELTRUDIS	\$68.00	ALCHEMY LUXE	\$19.00	AMAZING MAZE	\$66.00	ANTHEMION	\$61.97
2 CHANNEL	\$145.00	ADESO	\$18.00	ALCHEMY MLT LEA	\$20.00	AMAZING RACE	\$65.00	ANTHOLOGY	\$38.00
3D BLOCKS	\$28.00	ADESTAN	\$58.97	ALCHEMY PEACOCK	\$30.00	AMBERTON	\$47.97	ANTIGUA	\$50.97
3D VIEW	\$25.00	ADMIRATION	\$59.00	ALCHEMY POM POM	\$78.00	AMBIENCE	\$68.97	ANTIQUE DESIGN	\$25.00
4 HARLEQUIN QLT	\$74.00	ADNERIS	\$50.00	ALCHEMY TASSEL	\$58.00	AMBIITION	\$89.00	ANTIQUE GARDEN	\$67.97
5.5 DIAMOND QLT	\$58.00	ADONIS	\$75.97	ALCHEMY TWIST	\$15.00	AMBO	\$35.00	ANTIQUED CORD	\$16.00
AALIYAH	\$51.97	ADONIS SCROLL	\$82.00	ALCHEMY VELVET	\$14.00	AMBOISE	\$73.97	ANTOINETTE ART	\$62.00
AARON	\$61.97	ADRASTEIA	\$88.00	ALDERFORD	\$55.00	AM-CREST	\$8.00	ANTOON	\$47.97
AARON STRIPE	\$26.00	ADRIANNA	\$6.00	ALECON	\$55.00	AMHERST	\$47.97	ANTSEY SQUARE	\$52.00
ABA STRIPE	\$48.00	ADRIEL	\$51.97	ALEDO	\$52.00	AMILLIANA	\$22.00	ANTURIO	\$34.00
ABBERLEY	\$70.00	ADULA	\$44.97	ALERO	\$39.00	AMPHORA	\$32.00	ANUJ	\$52.00
ABBEYDALE	\$42.97	ADVANTAGE	\$57.97	ALETA	\$30.00	AMSALE	\$23.97	ANY OTHER DAY	\$55.00
ABBEYLEIX	\$66.00	ADVISOR	\$52.97	ALEWIFE BROOK	\$52.00	AMURI	\$24.97	ANZIO	\$62.00
ABBEYWOOD	\$75.00	AEROBICS	\$47.97	ALEXA	\$18.00	ANACONDA	\$38.00	AOIFE	\$62.00
ABBY	\$27.97	AERODYNAMICS	\$32.00	ALGAZI	\$56.00	ANALIA	\$108.00	APADANA	\$113.97
ABBY ROAD	\$66.00	AFRA	\$72.00	ALGEBRAIC	\$42.00	ANALICE	\$30.00	APARICIO	\$50.00
ABBY STRIPE	\$30.00	AFTER HOURS	\$42.00	ALGOMA	\$20.00	ANANINDEAU	\$36.00	APOLLINAIRE	\$59.00
ABDENDRIEL	\$32.00	AFTER SUNSET	\$64.00	ALICE GARDEN	\$25.00	ANANZI	\$36.00	APPLE BLOSSOM	\$75.97
ABERCROMBIE	\$98.97	AFTERNOON WALK	\$65.00	ALICE WHITE	\$42.00	ANARA STRIPE	\$25.00	APPLE TREE	\$19.95
ABERDALE	\$42.00	AGASSI	\$62.00	ALICIA	\$87.97	ANAS FLOWERS	\$72.00	APPLES N PEARS	\$52.00
ABERO STRIPE	\$56.00	AGED DECADENCE	\$61.97	ALIVE	\$26.00	ANATASE	\$98.97	APRIL FLOWERS	\$65.00
ABIDE	\$67.97	AGELESS LINES	\$24.00	ALL FRAMED	\$73.97	ANATOLIA	\$46.00	APRIL LOVE	\$21.00
ABIGAIL STRIPE	\$26.00	AGOSTO	\$51.97	ALL IN CHECK	\$72.00	ANCHOR CHAIN	\$65.00	APRILIA	\$52.00
ABILA WAVE	\$30.00	AGUILERA	\$44.00	ALL MAGIC	\$24.00	ANCIENT ANGLE	\$72.00	APRIORI	\$68.00
ABLE BLOCK	\$42.00	AIMEE STRIPE	\$22.00	ALL SQUARED UP	\$80.00	ANCIENT PATH	\$72.00	APTOBE	\$43.97
ABOUT FACE	\$48.00	AINARA	\$108.00	ALL THAT JAZZ	\$45.97	ANCIENT PERSIA	\$64.00	AQUALINA	\$40.00
ABOVE BOARD	\$36.00	AIR AND WATER	\$119.00	ALLEMANDE	\$40.00	ANCIENT SCROLL	\$32.00	AQUAVITE	\$75.00
ABOVE CLARITY	\$89.00	AISLING	\$47.97	ALLENSPARK	\$47.97	ANCIENT WAYS	\$57.97	ARABELLA	\$56.00
ABRIL	\$68.00	AKIHITO	\$58.00	ALLEPEY	\$32.00	ANDRETTI	\$70.00	ARABESQUE	\$58.00
ABRIL STRIPE	\$59.00	AKRON	\$31.97	ALLIE STRIPE	\$68.00	ANDRIAN	\$45.97	ARAMINI	\$61.97
ABSTRACT IKAT	\$19.95	AKROTIRI	\$32.00	ALLISON	\$47.97	ANDROMEDA	\$93.97	ARANZA	\$62.00
ABSTRACT LEAVE	\$73.97	AL FRESCO BALL	\$71.97	ALLIUM	\$69.97	ANDRUZZI	\$65.97	ARAVALI	\$58.00
ABSTRACT PLAID	\$50.00	AL FRESCO BEAD	\$63.97	ALLOVER GLOW	\$28.00	ANDTRADA	\$75.00	ARBERRY	\$59.00
ABSTRACTION	\$75.97	AL FRESCO BRAID	\$31.97	ALMA SQUARES	\$48.00	ANDY	\$38.97	ARBOR HEIGHTS	\$77.97
ACANDA	\$50.00	AL FRESCO BRUSH	\$23.97	ALMONDS	\$42.00	ANETO	\$59.00	ARBOR MEADOWS	\$62.00
ACANTHUS	\$42.00	AL FRESCO CHAIR	\$47.97	ALMUDENA	\$70.00	ANGEL PEARLS	\$79.97	ARBORESCENT	\$46.00
ACCENT SHADES	\$67.97	AL FRESCO LOOP	\$33.97	ALOHA STRIPE	\$55.00	ANGEL WHISPERS	\$16.00	ARBORFORM	\$64.00
ACCENT STRIPE	\$48.00	AL FRESCO ROPE	\$65.97	ALONSO	\$55.00	ANGELIC FLORAL	\$74.00	ARCATA	\$44.00
ACCORDANCE	\$14.97	AL FRESCO TASSL	\$65.97	ALPENGLOW	\$54.00	ANGELIC MEADOW	\$45.00	ARCHAISM	\$38.00
ACETONIC	\$34.00	AL FRESCO TIEBK	\$83.97	ALPHABET SOUP	\$26.00	ANGELO	\$39.97	ARCHDUKE	\$51.97
ACHILL ISLAND	\$39.00	ALABAMA MOON	\$66.00	ALTAMIRANO	\$65.97	ANGIOLINI	\$62.00	ARCHED DOTS	\$28.00
ACOCELLA	\$52.00	ALAMOGORDO	\$52.00	ALTER EGO	\$41.97	ANGLE LANE	\$60.00	ARCHETYPE	\$102.00
ACOUSTIC WAVE	\$58.00	ALBERTSON	\$39.97	ALTERNATIVE	\$75.97	ANGLE PATH	\$62.00	ARCHIBONG	\$37.97
ACROPOLIS	\$84.00	ALBION	\$58.00	ALTON STRIPE	\$30.00	ANGLE WAY	\$58.00	ARCIFORM	\$66.97
ACT NATURALLY	\$42.00	ALCHEMY BAND	\$45.00	ALTON WEAVE	\$28.00	ANGLED QUAD	\$37.00	ARCOTEL	\$50.00
ACTIVE ROOT	\$70.00	ALCHEMY BORDER	\$30.00	ALWAYS	\$57.97	ANGUSTIAS	\$72.00	ARDENHILL	\$41.97
ACTUALITY	\$25.00	ALCHEMY BRACELT	\$160.00	ALWAYS SUMMER	\$32.00	ANIMAL CRACKER	\$78.97	ARDENT	\$76.00
ACUMEN	\$86.00	ALCHEMY BRAID	\$48.00	ALYSSA	\$37.97	ANISTON	\$45.97	ARDMORE	\$52.00
ADALIA	\$93.97	ALCHEMY BRUSH	\$24.00	AMAGANSETT	\$70.00	ANJOLIE	\$32.00	ARGILLA	\$56.00
ADDERTON	\$32.00	ALCHEMY CHAIR	\$104.00	AMALGAMATE	\$55.00	ANJORSKA	\$61.97	ARGYLE CHECK	\$42.00
ADDISON FLORA	\$42.00	ALCHEMY CORD	\$15.00	AMALI GARDEN	\$34.00	ANNA	\$20.00	ARISTA	\$24.00
ADDYSON	\$22.00	ALCHEMY CR TBCK	\$412.00	AMANDA VINE	\$78.00	ANNABELLE	\$38.00	ARISTON	\$45.00
ADELLINE	\$23.97	ALCHEMY DELUXE	\$38.00	AMANDAS WAY	\$28.00	ANNONE	\$69.00	ARIZONA DESERT	\$52.00
ADELLE	\$33.97	ALCHEMY GIMP	\$16.00	AMANDINE	\$69.97	ANSONIA FLEUR	\$56.00	ARIZONA WAY	\$80.00
ADELLE CRUSHED	\$51.97	ALCHEMY JEWELS	\$182.00	AMARYLLIS POSY	\$78.97	ANSWER	\$50.97	ARLINGTON COVE	\$51.97
ADELLE STRIPE	\$67.97	ALCHEMY JWEL TBK	\$168.00	AMAZE	\$65.97	ANTELOPE	\$172.00	ARMADALE	\$38.00
ADELPHIA	\$64.00	ALCHEMY KEY	\$58.00	AMAZEMENT	\$76.00	ANTHEAS WAY	\$59.00	ARMAGH	\$56.00

WHOLESALE TRADE PRICE LIST
800.333.3777

ROBERT ALLEN accepts MasterCard, Visa® and American Express

ROBERT ALLEN

PATTERN	PRICE	PATTERN	PRICE	PATTERN	PRICE	PATTERN	PRICE	PATTERN	PRICE
ARMENTI	\$48.97	AUDRITE	\$24.97	BACKLUND	\$77.97	BANJO	\$75.97	BEACH BUDDY	\$56.00
ARNAGE	\$45.00	AUNT BETTY	\$54.97	BACKSPIN	\$52.00	BANKSTOWN	\$65.97	BEACH CABANA	\$83.97
ARO	\$42.00	AUNT LILY	\$66.00	BACKTRACK	\$65.97	BANTRY	\$68.00	BEACH DAY	\$60.00
ARONA	\$44.00	AURA OF LUXURY	\$65.00	BACKYARD FUN	\$53.97	BANZIGER	\$69.97	BEACH MATS	\$34.00
ARRIVAL	\$36.00	AUSSIE	\$28.00	BADAJAZ	\$24.00	BAPTISTE	\$65.97	BEACH RESORT	\$48.00
ARROW WAY	\$61.97	AUSSIE SQUARE	\$66.00	BAHAMA STRIPES	\$47.97	BAR NONE	\$47.97	BEACH ROAD	\$25.00
ARROWPOINT	\$50.00	AUSTENE	\$75.97	BAHAMARAMA	\$49.00	BAR RAE	\$33.97	BEACH TOWEL	\$38.00
ARROWROOT	\$37.97	AUSTIN	\$121.97	BAINBRIDGE WAY	\$75.00	BARBADOS	\$62.97	BEACH UMBRELLA	\$25.00
ART BASEL	\$99.00	AUSTWELL	\$66.00	BAINVILLE 53	\$58.00	BARBYANN	\$77.97	BEAD BURST	\$54.00
ART LINES	\$30.00	AUTHENTIC	\$121.97	BAINVILLE 106	\$114.00	BARD	\$33.97	BEAD KEY	\$40.00
ART SCENE	\$26.00	AUTUMN BREEZE	\$50.00	BAJA WOVEN	\$34.00	BARDOLINO	\$49.97	BEAD STRIPE	\$41.00
ARTEMIS	\$42.00	AUTUMN ENCORE	\$58.00	BAKEWELL	\$65.97	BARELY THERE	\$26.00	BEAD TRIM	\$94.00
ARTIGIANO	\$74.00	AUTUMN FOLIAGE	\$25.00	BALADEVA	\$55.00	BARKERMAN	\$25.00	BEADED BUTTON	\$34.00
ARTISAN GLASS	\$74.00	AUTUMN GLOW	\$28.00	BALANCE	\$59.00	BARKERVILLE	\$42.00	BEADED DIAMOND	\$75.00
ARTISANAL	\$62.00	AUTUMN SCENE	\$44.00	BALBINA	\$33.97	BARKIN	\$55.00	BEADED FLOWER	\$78.00
ARTIST FALLS	\$72.00	AUTUMN SPHERE	\$71.97	BALBRIGGAN	\$52.00	BARNARD CASTLE	\$78.00	BEAR CANYON	\$30.00
ARTIST PRINT	\$78.00	AUTUMN VALLEY	\$32.00	BALCOLM	\$58.00	BARNSHAW	\$93.97	BEARNSON	\$75.97
ARTIST STYLE	\$52.00	AVACO	\$53.97	BALDACCINI	\$54.00	BAROQUE BEADS	\$62.00	BEASON	\$62.00
ARTISTS VEIL	\$33.97	AVADI SHINE	\$44.00	BALDANZA	\$73.97	BARRANQUILLA	\$34.00	BEATRIX	\$35.00
ARTSWIRE	\$70.00	AVALON BAY	\$42.00	BALDELLI PARK	\$30.00	BARRATEEN	\$32.00	BEAUCLERK	\$75.97
ASAMI	\$42.00	AVANZATA	\$42.00	BALDWIN PLAID	\$52.00	BARRE	\$23.97	BEAUFORT	\$58.00
ASH DOWN	\$35.97	AVAST	\$71.97	BALENCIAGA	\$54.97	BARREGO	\$65.97	BEAUMARIS	\$76.00
ASHA	\$50.00	AVELINE	\$38.00	BALFE	\$52.00	BARRIENTOS	\$32.00	BEAUTY IMAGE	\$54.97
ASHBURNHAM	\$48.97	AVELLA	\$75.97	BALFOUR	\$39.00	BARRIER	\$63.97	BEAUTY REMAINS	\$25.00
ASHBURTON	\$66.00	AVENTURA	\$84.00	BALIHI	\$66.00	BARROSO FIELD	\$26.00	BEAUTY SCENE	\$40.00
ASHBY RIB	\$46.00	AVENUE STRIPE	\$50.00	BALISTANO	\$14.00	BARTHOLOMEW	\$54.97	BECAUSE	\$62.00
ASHCROFT	\$30.00	AVENUE TO TIME	\$57.97	BALLARDVALE	\$42.00	BARTLETT FAIR	\$61.97	BECKO	\$28.00
ASHERTON	\$32.00	AVENZA	\$25.97	BALLEROY	\$71.97	BARTOLOZZI	\$77.97	BEDECKED	\$19.00
ASHEVILLE	\$52.00	AVEZZANO	\$20.00	BALLINBOGLE	\$25.00	BASALT	\$38.97	BEDELIA STRIPE	\$58.00
ASHLAND SQUARE	\$62.00	AVIARY	\$75.97	BALLINODE	\$38.00	BASHA	\$37.97	BEDMINSTER	\$74.00
ASKEW	\$25.00	AVOCA	\$80.00	BALLOON TRAIL	\$77.97	BASHFUL	\$77.97	BEDROCK	\$40.00
ASPASIA	\$28.00	AVON	\$172.00	BALLYCASTLE	\$56.00	BASIC DOTS	\$58.00	BEECH LANE	\$61.97
ASPEN LODGE	\$94.00	AWAKENING	\$53.97	BALLYDESMOND	\$42.00	BASIC SCENE	\$22.00	BEECHER FALLS	\$62.00
ASPEN SEASON	\$52.00	AWESOME VIEW	\$54.00	BALLYLANDERS	\$75.00	BASIC SPRING	\$54.00	BEFITTING	\$24.00
ASPEN STRIPE	\$34.00	AXIOM	\$62.00	BALLYMOE	\$51.00	BASIC STITCH	\$36.00	BEGIN AGAIN	\$55.00
ASPLENGLN	\$89.00	AYALA	\$47.97	BALLYSHANNON	\$44.97	BASIC SWIRLS	\$45.00	BEGUILE	\$24.97
ASPERITY	\$39.97	AYLA BLOOMS	\$61.97	BALMY	\$27.00	BASIMAH	\$77.97	BEHNAZ	\$46.00
ASTAMOR	\$42.00	AYR	\$27.97	BALOO	\$54.97	BASKET EFFECT	\$36.00	BEL ESPRIT	\$34.00
ASTERISM	\$48.00	AZARIA	\$77.97	BALSAWOOD	\$52.00	BASKET LANE	\$72.00	BELA FLECK	\$47.97
ASTERLING	\$38.00	AZRAEL	\$23.97	BALTIC CUFF	\$34.00	BASKET STITCH	\$38.00	BELCREST	\$103.97
ASTRO PEAKS	\$52.00	AZTEC CITY	\$69.00	BALUSTR KEY TSL	\$40.00	BASKET UP	\$36.00	BELDEN	\$87.97
ASTRONOMICAL	\$75.97	AZTEC FIELD	\$42.00	BALUSTR TIEBACK	\$99.00	BASKET WEAVE	\$52.00	BELGORA	\$107.97
ASUNCION	\$75.00	AZTEC FLOWERS	\$58.00	BALVENIE	\$34.00	BASKET WEDGE	\$19.95	BELLA LUNA	\$40.97
ATARI	\$66.00	AZTEC GARDEN	\$51.97	BALZERETTI	\$34.00	BASSETT HALL	\$69.00	BELLA NOVA	\$33.97
ATHEA	\$77.97	AZTEC LINES	\$32.00	BAMBOO BRUSH	\$26.00	BASTIEN	\$32.00	BELLE AMI	\$20.00
ATHENA ROAD	\$24.00	AZTEC PATHWAY	\$20.95	BAMBOO CORD	\$19.00	BASTROP	\$77.97	BELLE BLOOM	\$42.00
ATHENRY	\$66.00	AZTEC STRIPE	\$25.00	BAMBOO CROSSING	\$32.00	BATON ROUGE	\$30.00	BELLE CLAIRE	\$35.97
ATHLONE	\$55.00	AZTEC SYMBOL	\$52.00	BAMBOO FIELDS	\$78.97	BATTAGLIA	\$77.97	BELLE GLADE	\$47.97
ATIENO	\$54.97	AZTEC WIND	\$30.00	BAMBOO PALMS	\$75.97	BATTEN DOWN	\$70.00	BELLMORE	\$40.00
ATKINSON	\$57.97	AZTECA	\$30.00	BAMBOO ROUCHE	\$28.00	BATTENKILL	\$38.00	BELLOMY	\$41.97
ATLANTIS REEF	\$56.00	BABELS	\$36.00	BAMPUR	\$52.00	BATTERSEA	\$39.97	BELLTAB WALTZ	\$68.00
ATRIUM	\$54.00	BABETTE	\$70.00	BANDED BRAID	\$19.00	BAUBLE	\$60.00	BELMONT STRIPE	\$42.00
ATRIUM BLOOM	\$85.00	BABY ARTICHOKE	\$54.97	BANDERILLA	\$38.00	BAY BREEZE	\$42.00	BELNORD	\$44.00
ATTACHED	\$62.00	BABY KINGSTON	\$32.00	BANDEROLLES	\$68.00	BAYFIELD	\$30.00	BELTRAN	\$6.00
ATTERWAN	\$19.00	BABY OCELOT	\$74.00	BANDINI	\$81.97	BAYSIDE EXPO	\$30.00	BELWIN	\$60.00
ATTITUDE	\$54.00	BABY OSTRICH	\$118.00	BANDWIDTH	\$74.00	BAYSWATER	\$34.00	BENCHI	\$79.00
AUBREY SOLID	\$34.00	BABYSITTER	\$34.00	BANE BERRY LANE	\$32.00	BAYTOWN	\$59.00	BEND AROUND	\$55.00
AUDIX	\$60.00	BACK AND FORTH	\$42.00	BANGKOK CAFE	\$80.00	BEA	\$23.97	BEND THE RULES	\$50.00

WHOLESALE TRADE PRICE LIST
800.333.3777

ROBERT ALLEN accepts MasterCard, Visa® and American Express

ROBERT ALLEN

PATTERN	PRICE	PATTERN	PRICE	PATTERN	PRICE	PATTERN	PRICE	PATTERN	PRICE
BENDABLE	\$45.00	BISSONETTE	\$77.97	BOMBARDE	\$52.00	BRADY BUNCH	\$67.97	BRITIAH	\$34.00
BENETELLO	\$47.97	BISTOLFI	\$74.00	BOMBAY	\$118.00	BRADYS STRIPE	\$26.00	BRIXTON	\$40.97
BENGAL LATTICE	\$70.00	BIXBY BLOCKS	\$36.00	BOMBONA	\$32.00	BRAFFERTON	\$30.00	BROADLINES	\$38.00
BENNET	\$59.00	BIZZY	\$47.97	BONELLI	\$37.97	BRAID	\$19.97	BROADMEADE	\$30.00
BENNET STRIPE	\$19.97	BIZZY PLAID	\$38.00	BONESET	\$61.97	BRAIDED ROWS	\$58.00	BROCKETT WAY	\$62.00
BENTON CITY	\$56.00	BLACKWOOD	\$83.97	BONNEVILLE	\$28.00	BRAIDED TWIST	\$47.00	BROGAN	\$41.97
BENZONIA	\$55.00	BLAKE	\$21.97	BONNIEBRAE	\$88.97	BRAINTREE	\$65.97	BROKEN CIRCLES	\$59.00
BEOGA	\$40.00	BLAKE STRIPE	\$39.00	BONNINGTON	\$34.00	BRAMWELL	\$116.00	BROLIO	\$65.97
BEQUEST	\$50.00	BLANCA	\$108.00	BONTURA PLAID	\$59.00	BRANA	\$30.00	BROMSGROVE	\$77.97
BERBER STRIPE	\$68.00	BLANKET STREET	\$40.00	BOOKENDS	\$77.97	BRANSLE	\$34.00	BROMSTAD	\$55.00
BERETTA	\$64.00	BLANTON	\$52.00	BOOMERANG	\$38.00	BRAZORIA	\$56.00	BRONZE AGE	\$96.00
BERKOFF	\$67.97	BLAUSER	\$94.97	BORDERFIELD	\$65.97	BRAZOS	\$11.97	BROOK VINES	\$34.00
BERMUDA RUN	\$26.00	BLENDVILLE	\$56.00	BORDERS	\$75.97	BREAK LINE	\$25.00	BROOKE ROAD	\$25.00
BERRA STRIPE	\$24.00	BLIND AMBITION	\$38.00	BORGEMEN	\$55.00	BREAK OF DAY	\$106.00	BROOKS RANGE	\$34.00
BERRY STEMS	\$38.00	BLING BLING	\$49.97	BOSCASTLE	\$34.00	BREAKFIELD	\$67.97	BROPHY FLORA	\$66.00
BERRY TIME	\$37.97	BLISSFUL	\$44.00	BOSTON BARK	\$38.00	BREAKING NEWS	\$31.97	BROWN TWEED	\$36.00
BERRYNABOUR	\$27.97	BLITHE	\$53.97	BOSTON MANOR	\$69.00	BREATHE IT IN	\$79.00	BROWNWOOD	\$68.97
BERYL	\$69.97	BLITHE CHECK	\$61.97	BOTANIC FLORA	\$60.00	BRECKSVILLE	\$34.97	BRUCEVILLE	\$42.00
BESPELLED	\$64.00	BLITHE STRIPE	\$57.97	BOTANY	\$42.00	BREDA	\$32.00	BRUNETTI	\$51.97
BESPOKE	\$71.97	BLOC GATHERING	\$69.97	BOTH SIDES NOW	\$55.00	BREEZY FLOWERS	\$59.00	BRUSCHI	\$45.97
BESTLANE	\$35.97	BLOCK STRIPES	\$38.00	BOTHWELL	\$36.00	BREEZY GLAM	\$40.00	BRUSH FRINGE	\$40.00
BESTOW	\$32.00	BLOCK WORKS	\$48.00	BOTKIER	\$24.00	BREEZY PALM	\$95.00	BRUSH STROKES	\$78.97
BETSABE	\$78.00	BLOCKS N DOTS	\$25.97	BOTTICELLI	\$321.97	BREGUET	\$31.97	BRUSHED GOVINA	\$122.00
BETSY GINGHAM	\$28.00	BLODWEN	\$37.97	BOTTLE GARDEN	\$79.00	BREIFNE	\$58.00	BRUSHED LINEN	\$42.00
BETTY JEAN	\$61.97	BLOIS	\$73.97	BOUCLE SOLID	\$20.95	BREMOND	\$19.95	BRUSHED UP	\$59.00
BETWEEN LINES	\$94.00	BLOMSTRA	\$69.00	BOUCLE TAPE	\$39.00	BRENHAM	\$38.00	BRUSHED ZIG	\$32.00
BEWILDERMENT	\$38.00	BLONDELL	\$47.97	BOUCLE TWEED	\$34.00	BRENT CROSSING	\$28.00	BRUSHWORK	\$47.00
BEYOND COLOR	\$42.00	BLOOM CITY	\$74.00	BOULDER IKAT	\$48.00	BRIA	\$31.97	BRUTUS	\$26.00
BHOPAL	\$58.00	BLOOM SEASON	\$50.00	BOULDER ROCKS	\$84.00	BRIANCHON	\$62.00	BUBBALOO	\$77.97
BIANCA	\$44.97	BLOOMERS	\$57.97	BOULLION ROUGE	\$47.97	BRICK BOX	\$32.00	BUBBLE AROUND	\$87.97
BIANCONI	\$37.97	BLOOMING DAISY	\$61.97	BOUNDLESS	\$94.00	BRICK PATIO	\$25.00	BUBBLE PLAY	\$46.00
BICEGO	\$84.00	BLOOMING FIELD	\$95.00	BOURBON	\$44.97	BRICK WHIRLS	\$40.00	BUCCELLATI	\$89.00
BIDEFORD BAY	\$36.00	BLOOMS ABOUND	\$68.00	BOUREE	\$65.00	BRICKLEY	\$38.00	BUDDING BLOOMS	\$34.00
BIG EASY	\$49.00	BLOSSOM DROPS	\$42.00	BOURNEWOOD	\$77.97	BRIDGE CITY	\$34.00	BUDDING PATH	\$28.00
BIG KAHUNA	\$49.00	BLOSSOM TIME	\$34.97	BOUTIQUE	\$22.00	BRIDGE ROW	\$30.00	BUDDING PETALS	\$36.00
BIG LEAVES	\$52.00	BLUE EYES	\$28.00	BOVINE FLOCK	\$28.97	BRIDGET	\$48.97	BUDDING STICK	\$48.00
BIG PLAID	\$42.00	BLUE HILL	\$42.97	BOWS ALONG	\$55.00	BRIDGEWELL	\$66.00	BUDDYS DOTS	\$52.00
BIG RINGS	\$61.97	BLUE JAY	\$84.00	BOWTIE QUILT	\$77.97	BRIERCOURT	\$67.97	BUENA VISTA	\$122.00
BIG SPRING	\$48.00	BLUE JEANS	\$32.00	BOX CUBE	\$62.00	BRIERFIELD	\$56.00	BUFFALO CREEK	\$57.97
BIG STREAM	\$42.00	BLUE PAD	\$30.00	BOX GRID	\$20.97	BRIETTA	\$57.97	BUFFINGTON SQ	\$42.00
BIG STRIPE	\$52.00	BLUEBIRD HAVEN	\$62.00	BOX HOLE	\$55.00	BRIGALOW	\$78.00	BUILDING BLOCK	\$40.00
BIGGLESWADE	\$73.97	BLUMENTHAL	\$51.97	BOX ILLUSION	\$42.00	BRIGHT BLOCKS	\$26.00	BUKHARA	\$45.00
BILLIARD	\$41.97	BLURRED LINES	\$69.00	BOX JUNCTION	\$39.00	BRIGHT EYES	\$32.00	BULLION 4"	\$61.97
BILLOWING	\$84.00	BOAT STRIPE	\$38.00	BOX MOTION	\$37.97	BRIGHT SWIRLS	\$22.00	BULLION 8"	\$93.97
BILLOWY	\$34.00	BOCA LINDA	\$39.00	BOX TURTLE	\$66.00	BRIGHTEN UP	\$24.00	BULLION BARS	\$50.00
BILLOWY CLOUDS	\$77.97	BOCCIA	\$59.97	BOXED MOSAIC	\$47.97	BRIGHTMAN	\$57.97	BULLION BRSH FR	\$36.00
BILSON	\$56.00	BODYWORK	\$42.00	BOXED PLAID	\$52.00	BRIGHTWOOD	\$26.00	BULLION TRAIL	\$41.00
BILSON BK	\$56.00	BOKGESE	\$67.97	BOXED SQUARES	\$42.00	BRIILLIANT EYES	\$27.97	BULVERDE	\$30.00
BINGLEY	\$69.97	BOKHARA	\$60.00	BOXES	\$58.00	BRIILLIANTINE	\$59.00	BUMPY ROAD	\$38.00
BINTO	\$29.00	BOLD DIAMOND	\$42.00	BOXY ZIG	\$24.00	BRINDLE	\$20.00	BUNDORAN	\$70.00
BIRCHBAY	\$57.97	BOLD FLORAL	\$25.00	BOYACA	\$38.00	BRINDLED BOXES	\$26.00	BUNGAY ROAD	\$65.97
BIRCHMONT PARK	\$61.97	BOLD LINKS	\$36.00	BOYDEN	\$38.97	BRINKLEY GROVE	\$48.97	BUNGEE	\$38.00
BIRD SONG	\$78.00	BOLD PLAID	\$32.00	BOYLAN	\$35.97	BRIO	\$32.00	BUNKER HILL	\$48.00
BIRDSEYE VIEW	\$20.95	BOLD RINGS	\$38.00	BOYLE	\$84.00	BRISA	\$72.00	BUNRATTY	\$69.97
BISCAYNE BAY	\$62.00	BOLD SCONCE	\$62.00	BOYNES	\$51.97	BRITE OUTLOOK	\$26.00	BUONICONTI	\$47.97
BISCELLI	\$75.97	BOLD VINES	\$62.00	BRACELET	\$43.97	BRITE PAISLEY	\$28.00	BURDEOS	\$52.00
BISHOP AUCKLAN	\$73.97	BOLDARI	\$78.97	BRADENBURG	\$61.97	BRITE PLAID	\$26.00	BURKESVILLE	\$61.97
BISHOP STRIPE	\$38.00	BOLZANO	\$74.00	BRADFIELD	\$84.00	BRITE-LINE	\$5.00	BURLAP WEAVE	\$42.00

WHOLESALE TRADE PRICE LIST
800.333.3777

ROBERT ALLEN accepts MasterCard, Visa® and American Express

ROBERT ALLEN

PATTERN	PRICE	PATTERN	PRICE	PATTERN	PRICE	PATTERN	PRICE	PATTERN	PRICE
BURLEY	\$40.00	CAMBERWELL	\$33.97	CARTER NAPPED	\$10.00	CENTER CIRCLE	\$78.00	CHELIOS	\$45.97
BURN CREST	\$25.00	CAMBRIDGE BAY	\$73.97	CARTERS GROVE	\$40.00	CENTER FIELD	\$55.00	CHELSEA	\$172.00
BURNETT	\$75.97	CAMDEN GARDEN	\$56.00	CARTIER	\$42.00	CENTER SQUARE	\$38.97	CHELSEA DREAM	\$61.97
BURNING HEART	\$62.00	CAMEO SCROLL	\$38.00	CARTWRIGHT	\$24.00	CENTER STAGE	\$71.97	CHELSEA GARDEN	\$47.97
BURNISHD METAL	\$90.00	CAMP EVERGREEN	\$42.00	CARUPANO	\$24.00	CENTER VINE	\$40.00	CHENGDU	\$48.00
BURNY	\$36.00	CAMPING STRIPE	\$28.00	CASCADE	\$25.97	CENTERVILLE	\$38.97	CHENILLE BARS	\$46.00
BUSY BASICS	\$58.00	CAMPOBELLO	\$72.00	CASCADING BEADS	\$36.00	CENTRAL STRIPE	\$44.00	CHENILLE RIB	\$40.00
BUSY BEES	\$71.97	CAMPORA	\$66.00	CASEY DIAMOND	\$72.00	CENTURY	\$81.97	CHENILLE ROW	\$71.97
BUSY PETAL	\$42.00	CAMPUS STRIPE	\$52.00	CASHMINA	\$47.97	CERISSA	\$103.97	CHENILLE SPECK	\$36.00
BUSY STRIPES	\$44.00	CAMRYN	\$39.97	CASILDA BAY	\$56.00	CERVASIO	\$67.97	CHENILLE SPOTS	\$44.97
BUTLAR	\$45.97	CANALETTO	\$59.00	CASILLAS	\$40.00	CHACONNE	\$28.00	CHENILLE WAVES	\$36.00
BUTTERFIELD	\$41.97	CANDLEWAY	\$40.97	CASPARINI	\$38.00	CHAIN OF BOWS	\$28.00	CHENONCEAU	\$18.00
BUTTERFLY	\$77.97	CANDLEWICK	\$40.00	CASS	\$55.00	CHAINLINK BAND	\$62.00	CHERICO	\$55.97
BUTTERFLY PLACE	\$88.97	CANE	\$90.00	CASSABLANCA	\$28.00	CHAINS	\$86.00	CHERISH	\$78.00
BUTTERFLY VINE	\$54.97	CANIGLIA	\$77.97	CASSANDRA	\$54.97	CHAINSTITCH	\$66.00	CHERRY BROOK	\$42.00
BUZZY BOY	\$39.00	CANILLO	\$56.00	CASSEL	\$28.00	CHAIR TIE	\$80.00	CHERRY JUBILEE	\$65.97
CABANA	\$19.95	CANING BRAID	\$32.00	CASTAWAY	\$70.00	CHALICE	\$67.97	CHERRYFIELD	\$66.00
CABANA BAR	\$68.00	CANNAROZZO	\$73.97	CASTEL	\$25.97	CHALLENGER	\$42.00	CHESTNUT HILL	\$38.00
CABANA TERRY	\$136.00	CANOGA	\$67.97	CASTLE ACRE	\$172.00	CHAMBA COTTON	\$28.00	CHESUNCOOK	\$75.00
CABANA WAY	\$58.00	CANOPY STRIPE	\$78.97	CASTLE BRIAR	\$75.00	CHAMBONNEAU	\$25.97	CHETAN	\$65.00
CABIN COVERLET	\$55.00	CANTERBURY WAY	\$61.97	CASTLE CARY	\$57.97	CHAMEIRIS	\$36.00	CHEVETTE	\$53.97
CABIN CREEK	\$62.00	CANTILEVER	\$34.00	CASTLE ISLAND	\$44.00	CHAMELEON	\$75.00	CHEVONNE	\$39.97
CABIN PLAID	\$35.97	CANTINA STRIPE	\$25.00	CASTLE POINT	\$42.00	CHAMPION	\$59.00	CHEVRON BAND	\$24.00
CABIN WEAVE	\$63.97	CANTORIAL	\$64.00	CASTLE ROCK	\$75.97	CHANDIGARTH	\$52.00	CHEVRON BOUCLE	\$30.00
CABLE CORD	\$51.97	CANVAS SHEEN	\$19.95	CASTLEBRIDGE	\$70.00	CHANDRIMA	\$39.00	CHEVRON IKAT	\$48.00
CABLESTITCH	\$16.95	CANVAS TEXTURE	\$20.00	CASTLEDERMOT	\$62.00	CHANEL TWEED	\$35.00	CHEVRON ROW	\$54.97
CABO VERDE	\$75.97	CANYON BEAUTY	\$72.00	CASTLEREA	\$84.00	CHANNEL CUT	\$82.00	CHEVRON STITCH	\$44.00
CABOODLE	\$74.00	CANYON STRIPE	\$44.00	CASTLEWOOD	\$72.00	CHANNEL UP	\$77.97	CHEVRON STRIE	\$46.00
CABOT PARK	\$68.00	CAPE LOOKOUT	\$72.00	CASUAL ART	\$44.00	CHANNING	\$24.00	CHIC BOUCLE	\$49.00
CACERES	\$26.00	CAPE POINT	\$40.00	CASUAL MIX	\$26.00	CHANHAVY	\$32.00	CHIC DIAMOND	\$61.97
CACTUS BUD	\$53.97	CAPITAL HILL	\$38.00	CASUAL TWILL	\$53.97	CHAPELIZOD	\$68.00	CHIC PARQUET	\$69.97
CADET	\$41.97	CAPRI	\$54.97	CASUAL WAY	\$26.00	CHAR KOOSTA	\$52.00	CHIC SPIRIT	\$25.00
CADOGAN	\$47.97	CAPRIATI	\$61.97	CATA RINGS	\$59.00	CHARACTERS	\$68.00	CHIC STRIPE	\$52.00
CAFARELLA	\$31.97	CAPSULE	\$49.00	CATALINA PLAID	\$32.00	CHARLAND	\$81.97	CHICO	\$19.95
CAFFREY	\$33.97	CAPTIVATE	\$67.97	CATALONIA	\$65.00	CHARLEMAGNE	\$76.00	CHICORA STRIPE	\$24.00
CAGE HEAT	\$48.00	CAQUETA	\$42.00	CATAMARCA CITY	\$36.00	CHARLESVIEW	\$40.00	CHILALI	\$81.97
CAICEDO	\$25.00	CARABELLE	\$72.00	CATANESE	\$67.97	CHARLEVOIX	\$100.00	CHILLIN	\$46.97
CAIRN HILL	\$48.00	CARAMBA	\$47.97	CATAPULT	\$42.00	CHARLO	\$44.00	CHIMENEA	\$54.97
CAIRO BAZAAR	\$130.00	CARDELLO	\$73.97	CATERPILLAR	\$71.97	CHARM CITY	\$55.00	CHIMERIC	\$28.00
CAKE WALK	\$75.97	CARIDAD	\$75.00	CATHAY VILLAGE	\$29.97	CHARMED BOXES	\$48.00	CHINA BASKET	\$56.00
CALDAS	\$52.00	CARLINGFORD	\$27.97	CAUCAIA	\$44.00	CHARMING PLAID	\$25.00	CHINA JOURNEY	\$71.97
CALDY	\$38.00	CARLTON	\$65.97	CAUSEWAY	\$77.97	CHARMING VIEW	\$30.00	CHINATI	\$28.00
CALEXICO	\$60.00	CARLYLE	\$51.97	CAVERNOUS	\$66.00	CHATTING CHICKS	\$54.00	CHINNY FUR	\$74.00
CALIBIO	\$30.00	CARMAGUE	\$48.00	CAYMAN BRAC	\$42.00	CHATTINGHAM	\$69.00	CHIPPANOCK	\$26.00
CALION	\$43.97	CARMANE	\$78.00	CAZENOVIA	\$57.97	CHAUVIN	\$36.00	CHIPPER WAY	\$52.00
CALLIGRAPHY	\$52.00	CARMINDA	\$46.00	CECCA	\$48.00	CHAYLA	\$24.97	CHIPPEWA	\$79.00
CALLIGRAPHY BD	\$36.00	CARNEGIE WAY	\$24.00	CEDAR BLUFF	\$42.00	CHECK BY CHECK	\$28.00	CHIT CHAT	\$32.00
CALLISBURG	\$26.00	CAROLINE	\$53.97	CEDAR PARK	\$59.00	CHECK UP	\$73.97	CHIVERNY	\$13.97
CALLY SQUARE	\$67.97	CAROLINE ISLE	\$35.00	CEDAR POINT	\$42.00	CHECKED LINES	\$19.95	CHIVERTON	\$24.00
CALM WATERS	\$26.00	CAROWINDS	\$45.00	CEDAR SPRINGS	\$43.97	CHECKER FLAG	\$52.00	CHLOE	\$23.97
CALMING EFFECT	\$59.00	CARRICK BEND	\$62.00	CEDAR STRIPE	\$58.00	CHECKER GAME	\$45.00	CHOCO	\$42.00
CALMNESS	\$68.00	CARRINGTON	\$64.00	CEDARBROOK	\$42.00	CHECKER PANEL	\$29.97	CHRISFIELD	\$51.97
CALTHA	\$25.00	CARRIZALES	\$45.97	CEE CEE	\$74.97	CHECKER STREET	\$30.00	CHRISTINE	\$56.00
CALVIN STRIE	\$44.00	CARROWKEEL	\$62.00	CEILI	\$73.97	CHECKERED OUT	\$39.00	CHRISTY LEE	\$75.00
CALYER	\$28.00	CARROWMORE	\$52.00	CELESTINE	\$84.00	CHECKERED TILE	\$38.00	CHROMA STRIPE	\$52.00
CALYPSO BREEZE	\$56.00	CARRS HILL	\$69.00	CELESTRIAL GLO	\$82.00	CHECKMATE	\$32.00	CHROMAPIXEL	\$50.00
CALYPSO NIGHT	\$49.00	CARTAGO	\$44.00	CELOSIA	\$42.00	CHEETAH SKIN	\$74.00	CHRONICLE	\$42.00
CAMAY	\$69.97	CARTELLIER	\$50.97	CELTIC KNOT	\$79.00	CHEETAH SPOTS	\$28.00	CHUBUT	\$38.00

WHOLESALE TRADE PRICE LIST
800.333.3777

ROBERT ALLEN accepts MasterCard, Visa® and American Express

ROBERT ALLEN

PATTERN	PRICE	PATTERN	PRICE	PATTERN	PRICE	PATTERN	PRICE	PATTERN	PRICE
CHULETA	\$56.00	CLASSIC SOLID	\$52.00	COLLY WOBBLER	\$75.00	CONTORNO	\$71.97	COTTRELL	\$50.00
CHUNG	\$75.00	CLASSIC STRIPE	\$19.00	COLONY HILL	\$52.97	CONTORTED	\$66.00	COTULLA	\$56.00
CIDER BROOK	\$26.00	CLASSIC TAPE	\$9.00	COLOR BLOCKS	\$55.00	CONTOURED LEAF	\$34.97	COUNTRY CABIN	\$66.00
CIELO	\$35.97	CLASSIC TIEBACK	\$58.00	COLOR BOXES	\$70.00	CONTREDANSE	\$36.00	COUNTRY CLUB	\$34.00
CIGAR BOX	\$83.97	CLASSIC TSL FRG	\$26.00	COLOR DOTS	\$62.00	CONVECTION	\$62.00	COUNTRY LANE	\$74.00
CINDERELLA	\$61.97	CLASSIC TWIST	\$9.00	COLOR EFFECT	\$38.00	CONVEXITY	\$61.97	COUNTRY LIFE	\$30.00
CINEAD	\$30.00	CLASSIC WAY	\$65.00	COLOR GARDEN	\$32.00	CONVOLUTION	\$61.97	COUNTRY PARK	\$26.00
CIOTTOLO	\$25.97	CLASSIC WEAVE	\$30.97	COLOR GRIDS	\$39.00	CONWAY	\$37.97	COUNTRY PLAINS	\$32.00
CIPHER	\$32.00	CLASSY MOTIF	\$88.00	COLOR GUIDES	\$36.00	COOL BAYOU	\$49.00	COUNTRY STRIPE	\$32.00
CIRCLE AROUND	\$34.00	CLAUDEL	\$26.00	COLOR LINES	\$56.00	COOL DOTS	\$48.00	COUNTRY SUMMER	\$38.00
CIRCLE ART	\$52.00	CLAVELINA	\$34.00	COLOR PALETTES	\$34.00	COOL IMPRINTS	\$26.00	COUNTRY VINE	\$30.00
CIRCLE BANDS	\$52.00	CLEAN LINES	\$45.00	COLOR PATCH	\$34.00	COOL REED	\$93.97	COUNTY CORK	\$37.97
CIRCLE CIRCLE	\$75.97	CLEAR INTENT	\$34.00	COLOR SPLASH	\$44.00	COOL STRIPES	\$42.00	COURANTE	\$36.00
CIRCLE GROVE	\$40.00	CLEARNESS	\$62.00	COLOR WEAVE	\$52.00	COOPER FOLLY	\$70.00	COURTSHIP	\$62.00
CIRCLE JOINERS	\$66.00	CLEO	\$52.00	COLORETTA	\$58.00	COPEVILLE	\$58.97	COURTYARD VINE	\$65.00
CIRCLE MAZE	\$48.00	CLEOS BREEZE	\$69.00	COLORFUL LANES	\$79.97	COPLEY SQUARE	\$44.97	COVE TREASURE	\$66.00
CIRCLE N DOTS	\$42.00	CLIFFDELL	\$41.97	COLORFUL REEF	\$52.00	COPPELIA	\$138.97	COVEDALE	\$24.97
CIRCLE OF LIFE	\$42.00	CLIMBING LEAF	\$53.97	COLORFUL RULER	\$32.00	CORAL	\$80.00	COZY BLANKET	\$70.00
CIRCLE RINGS	\$40.00	CLINGING VINES	\$50.00	COLTIN	\$29.00	CORAL POINT	\$73.97	COZY CABIN	\$54.97
CIRCLE ROW	\$42.00	CLIP IT	\$52.00	COLVIN	\$69.97	CORBETT	\$27.97	COZY STRIPE	\$57.97
CIRCLE RUNWAY	\$44.97	CLIPPED FRAME	\$54.00	COMB FENCING	\$55.97	CORBUCKLE	\$46.00	CRACKER LINES	\$32.00
CIRCLE SCALLOP	\$42.00	CLIPPER SOLID	\$43.97	COMBED MEADOW	\$56.00	CORBY SQUARE	\$65.97	CRACKLE BRITE	\$30.00
CIRCLE SONNET	\$84.00	CLIQUE	\$41.00	COMBERTON	\$57.97	CORDED LOOP	\$36.00	CRACKLED EFFECT	\$67.97
CIRCLE TEXTURE	\$16.95	CLOCK TOWN	\$42.00	COMETS RUN	\$52.00	CORDELLA	\$81.97	CRAIGVILLE	\$28.00
CIRCLE TRELIS	\$68.00	CLOCK WORK	\$52.00	COMFORT ZONE	\$55.97	CORDITA	\$65.00	CRATER LAKE	\$28.00
CIRCLE WITHIN	\$39.00	CLOE	\$61.97	COMFY LIVING	\$42.00	CORDOVANI	\$73.97	CRAZY MAZE	\$50.00
CIRCLING	\$40.00	CLOE FLORA	\$54.00	COMFY QUILT	\$55.00	CORDOVER	\$57.97	CRAZY PATCH	\$58.00
CIRCUIT LINE	\$45.00	CLOGHEEN	\$42.00	COMICAL	\$46.00	CORFIELD	\$67.97	CREAM PUFFS	\$56.97
CIRCULO GRANDE	\$66.00	CLONAMORE	\$42.00	COMITATO	\$74.00	CORN MAIZE	\$52.00	CREAMY BLEND	\$52.00
CIRCUS FUN	\$48.00	CLOTH PLAID	\$56.00	COMMAND STRIPE	\$51.97	CORN STRIPE	\$74.00	CREATIVE GEO	\$48.00
CIREBON	\$52.00	CLOUD SHADOWS	\$58.00	COMMIX	\$55.00	CORNELLAND	\$65.97	CREATIVE IDEA	\$42.00
CIRENIA	\$75.00	CLOUDING	\$6.00	COMMOTION	\$46.00	CORNER DOTS	\$42.00	CREATIVE MIX	\$54.00
CIRRUS	\$61.97	CLOVER SPIN	\$30.00	COMPACT COLOR	\$38.00	CORNER SQUARE	\$22.00	CREATIVE NET	\$72.00
CITADEL	\$31.97	CLUB CAR	\$110.00	COMPEL	\$54.97	CORNERSHELF	\$58.00	CREEK BED	\$46.00
CITY INFLUENCE	\$67.97	CLUSTER EVE	\$57.97	COMPLICATED	\$48.00	CORNFIELD MAZE	\$62.00	CREEPING VINE	\$24.00
CITY PLAID	\$52.00	COASTAL CORAL	\$80.00	COMPOSITE	\$84.00	COROFIN	\$52.00	CREIGHTON	\$5.00
CITY ROADS	\$27.97	COASTAL SAND	\$58.00	CONAN	\$49.97	CORREIA	\$81.97	CRESCENT HILL	\$74.00
CITY SIDEWALKS	\$38.00	COAT OF ARMS	\$71.97	CONCERT HALL	\$18.97	CORRENTI	\$34.00	CRESCENT PLACE	\$70.00
CITY STRIPES	\$61.97	COBBLE DIAMOND	\$36.00	CONCERTINA	\$84.00	CORSHAM	\$40.00	CRESILLA DK	\$45.97
CIVIL TWILIGHT	\$74.00	COBBLE LANE	\$54.00	CONCHATA	\$62.00	CORTE MADERA	\$24.00	CREST POINT	\$61.97
CLANDESTINE	\$75.97	COBBLE TRAIL	\$76.00	CONCISE	\$60.00	CORTINADA	\$25.00	CRESTVIEW	\$62.00
CLARA CITY	\$59.00	COBBLER WAY	\$26.00	CONDUIT	\$60.00	CORTLAND PLAID	\$42.00	CRESWICK	\$59.00
CLARDY	\$48.00	COBRA LILY	\$48.00	CONFETTI TOSS	\$52.00	COSGROVE	\$48.00	CREVICE	\$69.97
CLAREMORRIS	\$42.00	COCHLEAR	\$48.00	CONFIDE	\$63.97	COSMIC CATCH	\$34.00	CRINKLE AROUND	\$89.97
CLARITY	\$52.00	COCHRANE	\$67.97	CONFREDA	\$77.97	COSMIC GRID	\$51.97	CRINKLE CUT	\$78.00
CLARKSVILLE	\$78.97	COCONUT BAY	\$62.00	CONNECT BOXES	\$52.00	COSMO BLOOM	\$62.00	CRINKLE LINES	\$72.00
CLASSIC BEAD FG	\$19.00	CODMAN	\$33.97	CONNECT ONE	\$65.00	COSTONMIRIS	\$42.97	CRINKLE STITCH	\$61.97
CLASSIC BRAID	\$16.00	COEUR DE LYON	\$75.97	CONNECTED DOTS	\$39.00	COTE D SOLEIL	\$68.97	CRINKLE STRIPE	\$77.97
CLASSIC BRUSH	\$16.00	COHANNET	\$50.00	CONNECTED ROWS	\$48.00	COTOPAXI	\$84.00	CRINKLE VINES	\$89.97
CLASSIC CHAIR	\$22.00	COIMBRA	\$23.97	CONNECTIONS	\$68.97	COTSWOLD	\$51.97	CRINKLED SHEER	\$16.00
CLASSIC CORD	\$9.00	COINAGE	\$58.00	CONSCIOUS	\$78.00	COTTAGE GARDEN	\$78.00	CRISP N CLEAN	\$54.97
CLASSIC DESIGN	\$58.00	COJEDES	\$63.97	CONSENSUS	\$62.00	COTTAGE LANE	\$75.97	CRITERION	\$93.97
CLASSIC DOTS	\$48.00	COLBURN	\$49.97	CONSERVATIVE	\$30.00	COTTAGE STRIPE	\$22.00	CRONOS	\$38.00
CLASSIC GARDEN	\$38.00	COLIN	\$19.97	CONSERVATORY	\$15.00	COTTAGE WINDOW	\$36.00	CROP UP	\$46.00
CLASSIC LINES	\$24.00	COLISEUM	\$57.97	CONSORT	\$83.97	COTTER	\$36.00	CROSS COUNTRY	\$75.97
CLASSIC LISERE	\$87.97	COLLABORATE	\$40.97	CONSTELLATION	\$47.00	COTTON CANDY	\$28.00	CROSS FIELDS	\$42.00
CLASSIC OMBRE	\$39.00	COLLINA RIPPLE	\$57.97	CONTAGEM	\$44.00	COTTON LOOP	\$38.00	CROSS KNOT	\$24.00
CLASSIC SCROLL	\$16.00	COLLINSVILLE	\$32.00	CONTENTMENT	\$35.00	COTTON TWILL	\$25.00	CROSS LANE	\$70.00

WHOLESALE TRADE PRICE LIST
800.333.3777

ROBERT ALLEN accepts MasterCard, Visa® and American Express

ROBERT ALLEN

PATTERN	PRICE	PATTERN	PRICE	PATTERN	PRICE	PATTERN	PRICE	PATTERN	PRICE
CROSS REFERENCE	\$38.97	DALI	\$42.00	DECODE	\$62.00	DIAMOND BAND	\$40.00	DIAMOND WEAVE	\$58.00
CROSS ROAD	\$76.00	DALLIA	\$93.97	DECORAH	\$34.00	DIAMOND BLISS	\$51.97	DIAMOND ZONE	\$19.95
CROSS STITCHES	\$74.00	DALLENBACH	\$51.97	DECORATING FUN	\$36.00	DIAMOND BLOCKS	\$56.00	DIAMONDHEAD	\$44.97
CROSS STRIPE	\$38.00	DAMASK DAVAY	\$47.97	DEDHAM SQUARE	\$34.00	DIAMOND BOX	\$42.00	DIANNA	\$31.97
CROSS VINES	\$49.00	DAMSELFY	\$64.00	DEEPLY YOURS	\$50.00	DIAMOND BOY	\$56.00	DIAPHANOUS	\$61.97
CROSSCREEK	\$73.97	DANBY SQUARE	\$42.00	DEER CREEK	\$52.00	DIAMOND BRAID	\$40.00	DIEGO	\$12.00
CROSSMAN	\$54.97	DANCE ALONG	\$48.00	DEFINITY	\$37.97	DIAMOND BURST	\$24.00	DIFLEUR	\$67.97
CROSSVILLE	\$79.97	DANDY DAY	\$35.00	DEGEORGE	\$74.00	DIAMOND CABLE	\$55.00	DIGITAL BLOCKS	\$49.00
CROWN DIAMOND	\$58.00	DANEAU	\$42.97	DEGOSTINO	\$59.00	DIAMOND CENTER	\$67.97	DIGITAL PATH	\$62.00
CROWN JEWELS	\$50.00	DANGLE LOOP	\$44.00	DEIRDRA	\$97.97	DIAMOND CHAIN	\$48.00	DIGITAL WAVE	\$39.00
CROWN MANOR	\$40.97	DANIELA	\$33.97	DEJA VU	\$57.97	DIAMOND CLOUDS	\$51.97	DIGNIFIED	\$94.00
CROWN TOP	\$40.00	DANTZLER	\$42.00	DELACORTE	\$29.97	DIAMOND CORD	\$52.00	DILLY DALLY	\$68.97
CROWNING TOP	\$74.00	DAPHNE STRIPE	\$55.00	DELETREZE	\$57.97	DIAMOND CREST	\$61.97	DINESH	\$46.00
CRUELLA	\$59.00	DARASHIA	\$38.00	DELHI DELIGHT	\$58.00	DIAMOND CURVE	\$19.95	DIRAH	\$52.00
CRUSH ON YOU	\$61.97	DAREDEVIL	\$52.00	DELICATE BLISS	\$32.00	DIAMOND DAY	\$52.00	DIRECTOR	\$59.97
CRYPTON SUEDE	\$42.00	DARING CURVES	\$26.00	DELICATE WAVES	\$38.00	DIAMOND DOT	\$54.97	DISAMAR	\$48.00
CRYSTAL BUTTON	\$28.00	DARIUS	\$33.97	DELICATE WEAVE	\$25.00	DIAMOND DUST	\$44.00	DISCO DOTS	\$48.00
CRYSTAL COVE	\$32.00	DARK NIGHT	\$32.00	DELIGHTED	\$28.00	DIAMOND ECHO	\$47.97	DISCO LINES	\$39.00
CRYSTAL RIVER	\$74.00	DARLEY DALE	\$58.00	DELLACQUA	\$30.00	DIAMOND EMPIRE	\$24.00	DISCREET	\$46.00
CUBA	\$22.00	DARSCH	\$25.00	DELLUCCI	\$57.97	DIAMOND FACETS	\$59.00	DISEGNO	\$40.00
CUBE REPEAT	\$52.00	DART OVER	\$44.00	DELMANO	\$56.00	DIAMOND FENCE	\$66.00	DISHER	\$26.00
CUBE STITCH	\$46.00	DARTS	\$58.00	DELONGCHAMP	\$75.97	DIAMOND FLORAL	\$67.97	DISTANT DAWN	\$50.00
CUBETA	\$72.00	DASH STRIPE	\$44.00	DEMI SQUARE	\$75.97	DIAMOND FLOWER	\$75.97	DISTANT LIGHTS	\$56.00
CUBIC SQUARED	\$30.00	DASHES	\$52.00	DENNING	\$72.00	DIAMOND FRAMES	\$66.00	DISTRESS METAL	\$94.00
CUDWORTH	\$75.97	DASHFORD	\$54.97	DENNISON	\$64.00	DIAMOND GATE	\$65.97	DITTANY	\$79.00
CUFF LINKS	\$118.00	DASHING RINGS	\$56.00	DEROSA	\$74.00	DIAMOND INLAY	\$73.97	DIVIDED LANES	\$58.00
CUGINI	\$67.97	DASILVA	\$47.97	DERRYLIN	\$49.97	DIAMOND ISLE	\$45.97	DIVISION LINE	\$56.00
CULAH	\$82.00	DATA	\$56.00	DERVISH	\$62.00	DIAMOND JOE	\$45.97	DIVULGE	\$54.97
CULLIGAN	\$56.00	DAUNCY	\$74.97	DESEO	\$59.00	DIAMOND LINES	\$19.95	DOBSON STRIPE	\$25.00
CUNDINAMARCA	\$44.00	DAVENPORT	\$33.97	DESERT HILL	\$14.00	DIAMOND LINKS	\$54.97	DOCKER	\$77.97
CUPECOY	\$90.00	DAVEY	\$56.00	DESERT MAZE	\$77.97	DIAMOND MAC	\$48.00	DOGGA	\$34.00
CUPIDS ARROW	\$33.97	DAVIDSON	\$47.97	DESERT OASIS	\$71.97	DIAMOND MAZE	\$86.00	DOGGA STRIPE	\$35.00
CURBELO	\$74.00	DAVIS SQUARE	\$80.00	DESERT PARK	\$44.97	DIAMOND MOSAIC	\$71.97	DOLCE VITA	\$112.00
CURLY LEAF	\$39.00	DAWNING SUN	\$55.00	DESERT SHADOW	\$40.00	DIAMOND MOTIF	\$45.00	DOMINO EFFECT	\$71.97
CURLY MEADOW	\$42.00	DAWSON RANGE	\$30.00	DESERT VIEW	\$62.00	DIAMOND NET	\$69.00	DONAHUE	\$37.97
CURRICI	\$71.97	DAY TRIP	\$56.00	DESERTRAIL	\$67.97	DIAMOND PALM	\$54.97	DONARIA	\$48.00
CURTAIN CALL	\$62.00	DAYBREAK	\$61.97	DESIANT	\$75.97	DIAMOND PANE	\$74.00	DONGARY	\$25.00
CURVES	\$61.97	DAYLIGHT	\$53.97	DESIGN A MAZE	\$62.00	DIAMOND PARK	\$65.00	DONLEY	\$75.97
CURVY	\$22.00	DAYTON TEXTURE	\$42.00	DESIREE	\$44.97	DIAMOND PATCH	\$65.97	DONOROTICO	\$8.97
CURVY DOTS	\$36.00	DAZZLE DOTS	\$52.00	DESJARDINS	\$82.00	DIAMOND PICK	\$24.97	DOODLE	\$61.97
CURVY LEAF	\$24.00	DAZZLE ME	\$28.00	DESKIN	\$30.00	DIAMOND POCKET	\$26.00	DOODLE PAD	\$32.00
CUT CARAT	\$78.00	DE FERRAN	\$65.97	DESTINY	\$110.00	DIAMOND QUARTET	\$61.97	DOPPIO	\$34.00
CUT ROUCHE	\$20.00	DE LAURENTIS	\$46.00	DEVALLEY	\$62.00	DIAMOND QUEUE	\$33.97	DOPPLER	\$55.00
CUT STRIPE	\$73.97	DE SIGNET	\$55.00	DEVINE PATH	\$34.00	DIAMOND QUILT	\$50.00	DORA FLORA	\$28.00
CUTTING EDGE	\$51.97	DEAN COMMONS	\$50.00	DEVINE VINE	\$31.97	DIAMOND ROAD	\$75.97	DORCHESTER	\$25.00
CUTTYHUNK	\$44.00	DEANA LYNN	\$42.00	DEVINS WAY	\$49.00	DIAMOND SCROLL	\$54.00	DORI	\$27.97
DAEDAL	\$66.00	DEAREST	\$64.00	DEVIZES	\$22.00	DIAMOND SET	\$38.97	DORLISA	\$72.00
DAGETT	\$20.00	DEARHEART	\$49.97	DEYANIRA	\$72.00	DIAMOND SKY	\$61.97	DORY STRIPE	\$28.00
DAHLIA GARDENS	\$100.00	DEBENHAM	\$52.00	DEYO	\$52.00	DIAMOND SPECKS	\$36.00	DOS RIOS	\$57.97
DAILEY	\$59.00	DEBS DIAMOND	\$48.00	DIADORA	\$74.97	DIAMOND STEP	\$48.00	DOT ALONG	\$34.00
DAINTY DOTS	\$38.00	DECEMBER BRIDE	\$74.97	DIAGONAL DOT	\$53.97	DIAMOND STITCH	\$67.97	DOTS ALONG	\$82.00
DAINTY STITCH	\$46.00	DECO	\$122.00	DIAGONAL DRIFT	\$57.97	DIAMOND STRAND	\$37.00	DOTS BOUCLE	\$60.00
DAISY JUBILEE	\$47.97	DECO DOT	\$47.00	DIAGONAL LINES	\$38.00	DIAMOND SUEDE	\$97.97	DOTS GALORE	\$39.00
DAISY VASE	\$19.95	DECO FLAIR	\$94.00	DIAMANTINA	\$67.97	DIAMOND TUCK	\$36.00	DOTS N RIBBONS	\$35.00
DAKOTA DUNES	\$42.00	DECO IMAGE	\$24.97	DIAMAS DOT	\$40.00	DIAMOND VIEW	\$42.00	DOTTED BOXES	\$46.00
DAKOTA TRAIL	\$52.00	DECO INSPIRE	\$49.00	DIAMOND ARCH	\$25.00	DIAMOND VISTA	\$74.00	DOTTED DIAMOND	\$65.97
DALBY STRIPE	\$70.00	DECO PAISLEY	\$36.00	DIAMOND ASKEW	\$58.00	DIAMOND WALK	\$40.00	DOTTED ECLIPSE	\$60.00
DALEY	\$28.00	DECO POINT	\$46.00	DIAMOND ATLAS	\$46.00	DIAMOND WAY	\$52.00	DOTTED FRAME	\$51.00

WHOLESALE TRADE PRICE LIST
800.333.3777

ROBERT ALLEN accepts MasterCard, Visa® and American Express

ROBERT ALLEN

PATTERN	PRICE	PATTERN	PRICE	PATTERN	PRICE	PATTERN	PRICE	PATTERN	PRICE
DOTTED LINES	\$39.00	DRUMCONDRA	\$32.00	ECO GRACE	\$44.00	ELIJAH	\$48.97	EPOCH	\$38.00
DOTTED LOOPS	\$58.00	DUARTE	\$61.97	ECO IMPACT	\$50.00	ELISE	\$61.97	EPPERSON	\$40.00
DOTTED MULTI	\$32.00	DUBLIN PLAID	\$58.00	ECO LANE	\$42.00	ELISE DAMASK	\$67.97	EPSOM II	\$35.97
DOTTED PAISLEY	\$19.95	DUDLEY SQUARE	\$24.00	ECO LORING	\$52.00	ELISTANO	\$20.00	EQUAL ROWS	\$19.95
DOTTED ROW	\$42.00	DUET B/O	\$10.00	ECO NOD	\$48.00	ELITE FASHION	\$34.00	ERROL	\$75.97
DOTTED SCRIPT	\$42.00	DUET LT B/O	\$8.00	ECO OHNO	\$42.00	ELITE FLORAL	\$40.00	ESCABOSA	\$28.00
DOTTED STITCH	\$58.00	DULCIMER	\$52.00	ECO PAISLEY	\$32.00	ELIZAS GARDEN	\$38.00	ESCONDIDO	\$88.00
DOTTED TRELIS	\$58.00	DUMBELLS	\$62.00	ECO PARK	\$55.97	ELKANAH	\$25.00	ESOTERIC	\$133.97
DOTTED WAY	\$28.00	DUNCAN RANGE	\$60.00	ECO PASSAGE	\$44.00	ELLIE	\$75.97	ESSBEE	\$47.97
DOTTED ZIGS	\$42.00	DUNDAVE	\$42.00	ECO QUILT	\$45.97	ELLSBURY WAY	\$42.00	ESSEX STRIPE	\$34.00
DOTTY LANE	\$48.00	DUNKINVILLE	\$77.97	ECO ROAD	\$34.00	ELMCROFT	\$61.97	ESTEEM	\$51.97
DOTTY LEAF	\$42.00	DUOTONE LINEN	\$38.00	ECO SQUARE	\$36.97	ELMRIDGE ROAD	\$62.00	ETCH A SKETCH	\$81.97
DOUBLE BLOCK	\$52.00	DUQUESNE	\$59.00	ECO TIME	\$47.97	ELOIREDE	\$93.97	ETCHED AVIARY	\$40.00
DOUBLE BUBBLE	\$71.97	DURALLY	\$88.00	ECO VILLAGE	\$48.97	ELSMORE	\$70.00	ETCHED BOX	\$68.00
DOUBLE DAY	\$62.00	DURANGO	\$38.00	ECOLA POINT	\$58.00	ELYSIAN FIELDS	\$95.00	ETCHED VELVET	\$82.00
DOUBLE DELIGHT	\$66.00	DURGIN	\$44.00	ECSTASY	\$96.00	EMBARK	\$65.97	ETCHINGS	\$47.97
DOUBLE FEATURE	\$73.97	DURINDA STRIPE	\$29.00	EDDIE	\$30.00	EMBASSY ROW	\$40.97	ETHRIDGE	\$69.97
DOUBLE LOOK	\$35.00	DUSHENKO	\$88.97	EDEN POINTS	\$58.97	EMBELLSHED TSL	\$72.00	ETTA	\$33.97
DOUBLE MESH	\$72.00	DUSTY FLORA	\$54.00	EDEN VALLEY	\$24.00	EMERSON	\$71.97	EULALIA	\$75.00
DOUBLE PLAY	\$62.00	DYLAN	\$61.97	EDENPARK	\$77.97	EMMA	\$47.97	EUSTON SQUARE	\$40.00
DOUBLE SCROLL	\$46.00	DYNAMIC BARS	\$48.00	EDGAR	\$57.97	EMPERATRIZ	\$44.00	EVARIN	\$71.97
DOUBLE STRIPE	\$34.00	EAGLE CREEK	\$56.00	EDGE OF NIGHT	\$30.00	EMPEROR	\$122.00	EVEN OUT	\$62.00
DOUBLE TAKE	\$30.00	EAGLE PASS	\$84.00	EDGE STITCH	\$45.00	EMPIRE CITY	\$50.00	EVENING BLISS	\$25.00
DOUBLE THREAD	\$34.00	EARLY BLOSSOM	\$34.00	EDISTO	\$70.00	EMPIRE STRIPE	\$58.00	EVENING OUT	\$42.00
DOUBLE TIEBACK	\$160.00	EARLY LIGHT	\$62.00	EDSEL	\$61.97	ENCHANTED	\$55.00	EVENING SCROLL	\$41.97
DOUBLE TIME	\$75.00	EARLY MORNING	\$38.00	EDUARDO	\$53.97	ENCHANTMENT	\$26.00	EVENING SKY	\$20.00
DOUBLE TWILL	\$31.97	EARTH ELEMENTS	\$45.00	EDUBIS	\$70.00	ENCINO STRIPE	\$65.00	EVERBLOOM	\$44.00
DOUBLE ZIPLINE	\$62.00	EARTHY ANGLE	\$31.97	EDWINA	\$46.00	ENCOURAGE	\$40.00	EVERDEEN	\$28.00
DOUGAL STRIPE	\$52.00	EARTHY CHIC	\$55.00	EGG HUNT	\$74.00	ENCRYPTED	\$47.97	EVERMORE AV	\$20.97
DOVENRY	\$78.00	EAST BAY	\$23.97	EGYPT EXPRESS	\$26.00	ENDLESS	\$32.00	EVETTA	\$38.97
DOWNEY 54	\$5.00	EAST BOUND	\$64.00	EIDELMAN	\$41.97	ENDLESS HILLS	\$61.97	EXALT	\$33.97
DOZIER	\$47.97	EAST GARDNER	\$32.00	EIGHT SQUARE	\$52.00	ENDLESS MAZE	\$32.00	EXAM	\$50.97
DRAGON LIZARD	\$52.00	EAST HAVEN	\$61.97	EILA	\$75.00	ENDLESS PATHS	\$44.00	EXCITING	\$26.00
DRAKE ESTATES	\$34.00	EAST HORIZON	\$19.95	EL ROSAL	\$33.97	ENDLESS STRIPE	\$48.00	EXHILARATION	\$80.00
DRAW STRING	\$57.97	EASTBRANCH	\$67.97	EL TESORO	\$66.00	ENDLESS TRAVEL	\$61.97	EXOTICA	\$61.97
DRAWBRIDGE	\$38.97	EASTERN SHORE	\$74.00	ELBA PLAID	\$25.00	ENDRUSCHAT	\$34.00	EXPANSE	\$89.00
DRAWN OUT	\$42.00	EASY BREEZY	\$24.00	ELECTRIC WAVE	\$94.00	ENDURING	\$45.97	EXPANSION	\$81.97
DRAYTON PARK	\$28.00	EASY GOING	\$64.00	ELECTRIFY	\$34.00	ENEKO	\$48.00	EXPEDITION	\$51.97
DREAM AFFAIR	\$38.00	EASY LANE	\$42.00	ELECTRON	\$84.00	ENERGY SHIFT	\$58.00	EXPOSED	\$36.00
DREAM AWAY	\$22.00	EASY TWEED	\$40.00	ELEGANCE WAY	\$36.00	ENEVI	\$74.00	EXPRESS LANE	\$40.00
DREAM CHENILLE	\$59.00	EBEL	\$59.00	ELEGANT BEAUTY	\$74.00	ENFORCE	\$54.97	EXPRESSIVE	\$75.97
DREAM LAKE	\$52.00	EBULLIENT	\$76.00	ELEGANT BLOOM	\$32.00	ENGLISH GARDEN	\$44.97	EXQUADRA	\$65.00
DREAM LIFE	\$47.97	ECHO	\$61.97	ELEGANT BUDS	\$56.00	ENGLISH MANOR	\$32.00	EXQUISITE	\$61.00
DREAM SCENE	\$48.97	ECHO MANOR	\$24.00	ELEGANT FLAIR	\$18.97	ENGRAVING	\$18.00	EXTRA MILE	\$42.00
DREAM TIME	\$25.00	ECHO PLAID	\$61.97	ELEGANT FLORAL	\$54.00	ENKENBALL	\$28.00	EXTREME HEAT	\$20.00
DREAMING	\$71.97	ECKHART	\$57.97	ELEGANT FRAME	\$72.00	ENLIGHTEN	\$45.97	EYDA	\$48.00
DREAMS	\$56.00	ECO ARIA	\$45.97	ELEGANT OGEE	\$32.00	ENLIVEN	\$66.00	EYE CANDY	\$40.97
DRENA SILK	\$43.97	ECO BALANCE	\$48.97	ELEGANT SHEER	\$16.00	ENNISKERRY	\$48.00	EYE CATCHING	\$52.00
DRESS ME UP	\$35.00	ECO BOUCLE	\$40.97	ELEGANT SPRING	\$52.00	ENNISKILLEN	\$39.00	EYE SHADOW	\$25.00
DREZEK	\$33.97	ECO CANYON	\$35.00	ELEGANT SUZANI	\$42.00	ENRICH	\$74.00	EYE SPY	\$25.00
DRIFFIELD	\$75.00	ECO CENTRIC	\$37.97	ELEGANT SWIRLS	\$73.97	ENTHUSIAST	\$66.00	EYELET TAILS	\$77.97
DRINACH	\$57.97	ECO CIRCLE	\$33.97	ELEMENTAL FRISE	\$63.97	ENTRANCING	\$37.97	FABIO	\$38.97
DRIZZLED	\$58.00	ECO COOL	\$47.97	ELEMENTARY	\$34.00	ENTRELAZOS	\$68.97	FABIOLA	\$62.00
DROMBERG	\$80.00	ECO DASH	\$42.00	ELEMENTS	\$71.97	ENTWINING LINK	\$42.00	FACETS	\$93.97
DROPS OF DOTS	\$34.00	ECO ESQUE	\$40.97	ELENORA	\$30.00	ENVY	\$54.97	FACETTED BD FRG	\$94.00
DROZ	\$66.00	ECO FINALE	\$50.97	ELEPHANT EARS	\$45.00	EON	\$28.00	FADED FLORAL	\$39.00
DRUFF	\$34.00	ECO FINITY	\$54.00	ELERIA	\$38.00	EOS STRIPE	\$52.00	FADED MEMORIES	\$40.00
DRUMCLIFF	\$48.00	ECO FRESH	\$39.00	ELI	\$83.97	EPCOT	\$88.97	FADED SWIRLS	\$32.00

WHOLESALE TRADE PRICE LIST
800.333.3777

ROBERT ALLEN accepts MasterCard, Visa® and American Express

ROBERT ALLEN

PATTERN	PRICE	PATTERN	PRICE	PATTERN	PRICE	PATTERN	PRICE	PATTERN	PRICE
FADING FOLIAGE	\$40.00	FELLOWSHIP	\$67.97	FITZROVIA	\$54.00	FLORAL SWAY	\$68.00	FOND CHANT	\$75.00
FAINA	\$75.97	FENCE LINKS	\$62.00	FLAME ON	\$71.97	FLORAL SWIRL	\$66.00	FOND ILLUSION	\$78.00
FAINT FLORALS	\$36.00	FENCED IN	\$28.00	FLAME STITCH	\$51.97	FLORAL VELVET	\$88.97	FOND MEMORIES	\$57.97
FAINT LINES	\$55.00	FENCING	\$36.00	FLAMENCO	\$34.00	FLORAL WAY	\$72.00	FONTAINE BLEU	\$139.00
FAIR LADY	\$28.00	FENCING GRIDS	\$42.00	FLAMEWALKER	\$58.00	FLORAL WONDER	\$69.97	FONTELLA	\$79.97
FAIR TRADE	\$25.00	FENESTELLA	\$78.00	FLAMINGO BAY	\$75.97	FLORAVILLE	\$35.00	FORCEFIELD	\$63.97
FAIRFORD	\$67.97	FENG SHUI	\$65.97	FLAMINIAN	\$61.97	FLOUNCE	\$114.00	FORDWICH	\$67.97
FAIRHILL MANOR	\$32.00	FENWAY GARDEN	\$60.00	FLANNEL SUEDE	\$133.97	FLOW IN FREELY	\$20.00	FOREST HILLS	\$42.00
FAIRHOPE	\$28.00	FERMANAGH	\$69.97	FLASHY	\$52.00	FLOWER BRANCH	\$58.00	FOREST WEB	\$54.97
FAIRMONT	\$28.00	FERN CANOPY	\$67.97	FLATLANDS	\$40.00	FLOWER BUD	\$54.97	FOREVER FLORA	\$28.00
FAIRVIEW GREEN	\$74.00	FERN FRENZY	\$57.97	FLAVONE	\$41.97	FLOWER BUNCH	\$28.00	FOREVER FOREST	\$26.00
FAIRWOOD GLEN	\$43.97	FERN HILL	\$77.97	FLAWLESS	\$47.00	FLOWER CENTER	\$48.00	FOREVER STRIPE	\$24.97
FALL FLOWERS	\$38.00	FERN HOLLOW	\$58.00	FLAX IN BLOOM	\$62.00	FLOWER CHARM	\$62.00	FOREVER VELVET	\$30.00
FALL FUN	\$38.00	FERN MAZE	\$68.97	FLEETING	\$52.00	FLOWER DAZE	\$60.00	FORK VALLEY	\$84.00
FALL LINES	\$52.00	FERN SPRAY	\$46.00	FLEMING ROAD	\$26.00	FLOWER DEW	\$59.97	FORMATION II	\$76.00
FALLEN DOMINOS	\$48.00	FERNDALE FLORA	\$28.00	FLEUR	\$40.00	FLOWER DOT	\$55.00	FORT APACHE	\$57.97
FAMILY CREST	\$19.95	FERRAGAMO	\$52.00	FLEUR BRAID	\$38.00	FLOWER HABIT	\$73.97	FORT DAVIS	\$28.00
FAMILY FUN	\$67.97	FERRUM	\$119.00	FLEUR DE LACE	\$48.00	FLOWER HALO	\$52.00	FORTHRIGHT	\$42.00
FAMILY PHOTOS	\$42.00	FESTIVE	\$52.00	FLEUR DIAMOND	\$62.00	FLOWER HARVEST	\$77.97	FORTITUDE	\$60.97
FAMILY SECRET	\$30.00	FEUILLE	\$73.97	FLEURS APLENTY	\$52.00	FLOWER INLAY	\$61.97	FORTUNESWELL	\$73.97
FANATIC	\$53.97	FIDDLESTICKS	\$67.97	FLINTWICK	\$69.97	FLOWER LAND	\$42.00	FOSSIL INLAY	\$48.97
FANCOURT	\$32.00	FIELDSTONE	\$57.97	FLIP	\$41.97	FLOWER MAZE	\$54.97	FOSSIL LEAF	\$34.00
FANCY PLANTS	\$77.97	FIERO STRIPE	\$42.00	FLIP FLOPS	\$68.97	FLOWER N BERRY	\$16.00	FOUR LEAF	\$20.95
FANCY QUOTES	\$51.97	FIERY BLAST	\$80.00	FLIP UP	\$32.00	FLOWER OASIS	\$30.00	FOUR STAR	\$19.95
FANCY STITCH	\$49.00	FIESTA KEY	\$39.00	FLITTER	\$47.97	FLOWER PAISLEY	\$34.00	FOUR TIMES	\$38.00
FANCY STRIPES	\$58.00	FIESTA PARTY	\$40.00	FLOATING RINGS	\$74.00	FLOWER PARK	\$38.00	FOX HOLLOW	\$50.00
FANCY THAT	\$52.00	FIGURE EIGHT	\$79.00	FLOATING WEAVE	\$71.97	FLOWER PETALS	\$52.00	FOXHILL	\$79.97
FANEUIL STRIPE	\$49.00	FILAMENA	\$21.97	FLOOR PLAN	\$45.00	FLOWER PICKING	\$66.00	FOXTROT	\$61.97
FANNY	\$70.00	FILBERT	\$54.97	FLORAL ARRAY	\$68.00	FLOWER POINTS	\$52.00	FOXVALE	\$18.97
FANTASY ISLE	\$53.97	FILIGREE	\$59.00	FLORAL BASKET	\$64.97	FLOWER SCENE	\$42.00	FRACTAL	\$18.00
FANTASY MAZE	\$84.00	FILLED BOXES	\$26.00	FLORAL BECCA	\$48.00	FLOWER SCROLL	\$28.00	FRACTURED CAMO	\$42.00
FANWOOD	\$62.00	FINAL CALL	\$68.00	FLORAL CRUSH	\$34.00	FLOWER SKETCH	\$30.00	FRAGARIA	\$27.97
FAR AND AWAY	\$34.00	FINCHLEY	\$58.00	FLORAL DECOR	\$30.00	FLOWER SPRAY	\$25.00	FRAMED DOT	\$57.97
FAR HORIZON	\$61.97	FINE AND DANDY	\$58.97	FLORAL DELIGHT	\$28.00	FLOWER TOPS	\$48.00	FRANCOEUR	\$57.97
FAR OUT	\$64.00	FINE CHENILLE	\$39.00	FLORAL DESIGN	\$71.97	FLOWER VINE	\$77.97	FRANTELLA	\$65.97
FARELI	\$55.00	FINE LIVING	\$42.00	FLORAL DROP	\$65.97	FLOWERBOMB	\$38.00	FREDERICKSON	\$38.00
FARHI	\$42.00	FINE POINT	\$52.00	FLORAL FINERY	\$42.00	FLOWERCREST	\$62.00	FREE SPIRIT	\$62.00
FARIKA	\$31.97	FINE TEXTURE	\$24.00	FLORAL FRENZY	\$30.00	FLOWERING BUDS	\$16.00	FREEDOM TRAIL	\$46.00
FARM FIELD	\$53.97	FINEBERG	\$94.97	FLORAL GALA	\$36.00	FLOWERING MODE	\$22.00	FREELINE	\$54.97
FARRUCA	\$40.00	FINISH LINE	\$48.00	FLORAL GILT	\$68.00	FLOWERING TREE	\$25.00	FREESTYLING	\$58.00
FASHION SHOW	\$65.97	FINMARK	\$84.00	FLORAL GRACE	\$45.00	FLOWERING VINE	\$52.00	FREEZE FRAME	\$38.00
FASHION WAY	\$50.00	FINN DIAMOND	\$77.97	FLORAL GROWTH	\$25.00	FLOWERS GALORE	\$79.00	FREMY	\$75.00
FAST FLYING	\$34.00	FINNIGAN LANE	\$75.97	FLORAL INSET	\$42.00	FLOWING BRANCH	\$58.00	FRENCH KNOT	\$61.97
FAST LANE	\$43.97	FIONA	\$25.00	FLORAL LEAF	\$28.00	FLOWING BREEZE	\$45.00	FRENCH KNOT BK	\$64.00
FASTIDIOUS	\$63.97	FIONA QUILT	\$62.00	FLORAL MANOR	\$46.00	FLOWING FLOWER	\$32.00	FRENCH MEADOW	\$61.97
FAUNSDALE	\$22.00	FIORE GAMBO	\$38.00	FLORAL MEADOW	\$34.00	FLOWING FREELY	\$38.00	FRENCHTOWN	\$83.97
FAUX FOX	\$80.00	FIORELLA	\$62.00	FLORAL MEDLEY	\$88.97	FLOWING PALMS	\$55.00	FRENZY LEAF	\$36.97
FAVERSHAM	\$58.00	FIorentina	\$75.00	FLORAL MIRAGE	\$69.97	FLOWING PETAL	\$75.00	FREQUENCY	\$44.00
FAVORITE DOTS	\$52.00	FIRE AND ICE	\$84.00	FLORAL MOTIF	\$53.97	FLOWING RIVER	\$24.00	FRESH FIELDS	\$36.00
FEATHER BLOCK	\$82.00	FIRE BRICKS	\$44.00	FLORAL OPULENCE	\$79.97	FLOWING STREAM	\$52.00	FRESH FLOWERS	\$40.00
FEATHER FANS	\$48.00	FIRE CREST	\$56.00	FLORAL OVERLAY	\$31.97	FLOWING TIDE	\$48.97	FRESH LINES	\$22.00
FEEDBACK	\$44.00	FIRE SPARKS	\$46.00	FLORAL PASSAGE	\$61.97	FLYING NIMBUS	\$38.00	FRESH LOOK	\$45.00
FEEL GOOD	\$52.00	FIREPLACE	\$52.00	FLORAL RHAPSODY	\$90.00	FOG ISLAND	\$64.00	FRESH MELODY	\$42.00
FELCE	\$83.97	FIRST LIGHT	\$74.00	FLORAL SCENERY	\$89.00	FOGGY LINES	\$22.00	FRESH PICKED	\$40.00
FELICITAS	\$58.97	FIRST LOVE	\$78.00	FLORAL SERGE	\$57.97	FOGGY STRIPE	\$26.00	FRESH TAKE	\$55.00
FELINE FEELING	\$40.00	FIRST MORNING	\$82.00	FLORAL SPRAY	\$71.97	FOILLERET	\$42.00	FRESHNESS	\$75.00
FELIXSTOWE	\$57.97	FISHNET	\$81.97	FLORAL STAMP	\$26.00	FOLLOW ALONG	\$26.00	FRETWELL	\$81.97
FELLOW	\$35.00	FISKE	\$33.97	FLORAL STRETCH	\$26.00	FOLLOW ME	\$45.00	FRETWORK DECOR	\$40.00

WHOLESALE TRADE PRICE LIST
800.333.3777

ROBERT ALLEN accepts MasterCard, Visa® and American Express

ROBERT ALLEN

PATTERN	PRICE	PATTERN	PRICE	PATTERN	PRICE	PATTERN	PRICE	PATTERN	PRICE
FRETWORK GRID	\$42.00	GALLAGHER	\$77.97	GEOMETRY	\$52.00	GLIMMER STAR	\$42.00	GRAMS MAT	\$78.00
FRETWORK STRIE	\$25.00	GALLANT MAZE	\$50.00	GEORGE	\$69.97	GLINT RIBBON	\$48.00	GRAMS PARLOR	\$66.00
FREYA	\$54.97	GALLANTLY	\$59.00	GEORGIA STRIPE	\$34.00	GLINTWOOD	\$68.00	GRANADOS	\$52.00
FRIDA	\$72.00	GALLOWS	\$60.00	GEOSHAPE	\$57.97	GLITTER SCROLL	\$55.00	GRAND CAYMAN	\$55.97
FRINGE BENEFIT	\$31.97	GALWAY	\$49.00	GERHARD	\$62.00	GLITTERATTI	\$62.00	GRAND CENTRAL	\$39.00
FRINGE ROAD	\$58.00	GALWAY BAY	\$58.00	GERICKE	\$61.97	GLITZ	\$33.97	GRAND CHENILLE	\$36.00
FRISKA	\$45.00	GAMBADO	\$37.97	GHIRADELLI	\$18.97	GLOBAL ACTION	\$31.97	GRAND CIRCLE	\$48.00
FRITCH	\$19.95	GAME CHANGER	\$96.00	GIA	\$19.97	GLOBAL IKAT	\$19.95	GRAND HOTEL	\$28.00
FRIZZLES	\$74.00	GAME PIECE	\$26.00	GIACOMO	\$59.00	GLOBAL LUXURY	\$42.00	GRAND ISLE	\$88.97
FRODO	\$57.97	GANDERBAL	\$71.97	GIANNI	\$57.97	GLOBAL TEXTURE	\$16.95	GRAND LAUREL	\$45.00
FRONT ROW	\$38.00	GANSU	\$34.00	GIGI	\$93.97	GLOCKENSPIEL	\$68.97	GRAND PORTAGE	\$61.97
FRONZOLA	\$27.97	GARBETTI	\$69.97	GIGLI	\$27.97	GLOMARIS	\$108.00	GRAND SPRAY	\$19.00
FROSTED CAP	\$59.00	GARCIA	\$57.97	GILA MOUNTAIN	\$19.95	GLORIOLE	\$35.97	GRANDE CHECK	\$38.00
FRUIT FANTASY	\$77.97	GARDEN BED	\$66.00	GILARDIA	\$48.00	GLORY PLAID	\$28.00	GRANDE STRIPE	\$38.00
FRUITY STRIPES	\$32.00	GARDEN BLOOM	\$56.00	GILBERT STRIPE	\$62.00	GLORYBEE	\$38.00	GRANDMA MARY	\$36.00
FULL CIRCLE	\$44.00	GARDEN FARM	\$38.00	GILDED DUBAKU	\$16.00	GLOSSY DIAMOND	\$48.00	GRANGE HILL	\$71.97
FULL GRAIN	\$24.97	GARDEN FLOWER	\$36.00	GILDED LEAVES	\$26.00	GLOSSY SLITHER	\$49.00	GRANGER	\$24.97
FULL KEEL	\$69.00	GARDEN GLOW	\$59.00	GILDED SNAKE	\$94.00	GLOSSY STRIPES	\$38.00	GRANITE SITE	\$78.00
FULL MOON	\$31.97	GARDEN KEEPER	\$75.97	GILLIGAN	\$22.00	GLOSSY WAVE	\$70.00	GRANNYS QUILT	\$42.00
FULL PAISLEY	\$62.00	GARDEN LIFE	\$69.00	GILLON	\$59.97	GLOWING	\$22.00	GRANTSBORO	\$47.97
FULL RANGE	\$40.00	GARDEN PATIO	\$66.00	GILROY	\$67.97	GLOWING STRIPE	\$58.00	GRANULAR	\$36.00
FULL SAILS	\$40.00	GARDEN PLACE	\$75.97	GINGRASS	\$22.00	GLYMUR	\$40.97	GRAPHIC LINES	\$22.00
FULL STRIPE	\$58.00	GARDEN RIDGE	\$52.00	GIOVANNA	\$33.97	GO GINGHAM	\$25.00	GRAPHIC MAZE	\$50.00
FULL SWEEP	\$74.00	GARDEN SAFARI	\$36.00	GIRAFFE SPOTS	\$67.97	GO GO	\$41.97	GRAPHIC NATURE	\$45.00
FULLERTON	\$48.00	GARDEN SPRAY	\$44.00	GISELE	\$55.00	GO SHEER	\$32.00	GRASS HUT	\$49.00
FUN FRAME	\$24.00	GARDEN VINE	\$58.00	GIULIANO	\$77.97	GODAIGO	\$61.97	GRASSLAND	\$74.00
FUN FUR	\$80.00	GARDEN WALK	\$39.97	GIZA	\$57.97	GODDARD	\$55.00	GRASSLEY	\$69.97
FUN LOOPS	\$32.00	GARFIELD	\$54.97	GIZMO	\$22.00	GOLD LEAF	\$98.00	GRASSY DUNES	\$51.97
FUN NIGHT	\$39.00	GARFIELD PARK	\$32.00	GLACIER BAY	\$71.97	GOLDEN DREAM	\$58.97	GRASSY KNOLL	\$44.00
FUN PAISLEY	\$69.00	GARLAND BRUSH	\$38.00	GLACIER ICE	\$58.00	GOLDEN IMAGES	\$32.00	GRAZIELLA	\$46.00
FUN STRIPE	\$44.00	GARLAND GIMP	\$15.00	GLAD ALL OVER	\$62.00	GOLDEN PIQUE	\$57.97	GREAT HOPES	\$74.00
FUN TIME	\$62.00	GARLANDS	\$74.00	GLADIATOR	\$75.97	GOLDEN SLUMBER	\$52.00	GREAT MAZE	\$30.00
FUNKY LEOPARD	\$47.97	GARRAN GARDENS	\$36.00	GLAMIS	\$46.00	GOLDEN WEAVE	\$40.00	GREAT TIMES	\$40.00
FUNKY MAZE	\$42.00	GARROW	\$34.00	GLAMOROUS	\$62.00	GONE WILD	\$78.00	GREEK KEY BRAID	\$34.00
FUNZA	\$56.00	GASSA	\$34.00	GLAMOUR LOOK	\$45.00	GOOD FRIENDS	\$30.00	GREEK STRIPE	\$54.00
FUR FRINGE	\$28.00	GATCHELL	\$74.00	GLAMOUR SOLID	\$28.00	GOODEVE	\$65.97	GREELY	\$45.00
FUR TIEBACK	\$114.00	GATHERED TWINE	\$52.00	GLANDORE	\$42.00	GORDIAN KNOT	\$36.00	GREGANS	\$61.97
FURROW	\$34.00	GATHERING	\$40.97	GLASNEVIN	\$46.00	GORON CITY	\$28.00	GRENADA STRIPE	\$59.00
FURTADO	\$73.97	GATSBY	\$78.97	GLASS WINDOW	\$20.00	GORTEEN	\$68.00	GRENIER	\$66.00
FUTURA GRID	\$81.97	GAUDETTE	\$56.00	GLATZER	\$54.97	GOSAI	\$44.97	GRESSA	\$13.97
FUTURAMA	\$75.00	GAUDI	\$37.97	GLAVINE	\$9.00	GOSPORT	\$116.00	GRID BLOCKS	\$52.00
FUTURE AVE	\$32.00	GAZELLE	\$59.00	GLAZED GOVINA	\$116.00	GOTHENBURG	\$38.00	GRID BOX	\$32.00
FUTURE BAY	\$67.97	GEISHA GIRL	\$47.97	GLAZED LINEN	\$58.00	GOVINA	\$116.00	GRID FRAME	\$28.00
FUZZY FEELING	\$51.97	GELASIA	\$65.97	GLEN IVY	\$74.00	GOVINA COCOA	\$172.00	GRID PATCHES	\$30.00
FUZZY FLOWERS	\$58.00	GEM CHENILLE	\$49.00	GLEN ROSE	\$32.00	GOVINA PEARL	\$118.00	GRID SQUARED	\$22.00
GABINA	\$52.00	GEM TEXTURE	\$26.00	GLENBEIGH	\$80.00	GOVINA SAFFA	\$122.00	GRIDDED MAZE	\$19.95
GABRIELLA	\$54.97	GEMMA	\$31.97	GLENCOLMCILLE	\$52.00	GOVINA SNOW	\$166.00	GRIFFIN BAY	\$36.00
GADSDEN	\$77.97	GEMSTONE	\$56.00	GLENFARNE	\$50.00	GRACE	\$94.00	GRIMAUD	\$71.97
GAETANE	\$30.00	GEMVETO	\$59.00	GLENFINNAN	\$44.00	GRACE FALLS	\$24.00	GROOVED LANES	\$46.00
GAINSBOURG	\$52.00	GENEROUS	\$66.00	GLENORA ESTATE	\$54.97	GRACE OF HEART	\$68.00	GROOVED ROAD	\$68.00
GAITHER	\$47.97	GENIES ROBE	\$24.00	GLENVEAGH HILL	\$66.00	GRACE SHEER	\$25.00	GROOVED VIEW	\$107.97
GALAXY CONFETTI	\$67.97	GENTLE DREAM	\$27.00	GLENWOOD	\$75.97	GRACEFUL SWIRL	\$41.00	GROOVY LINES	\$50.00
GALAXY SPIRAL	\$28.00	GEO PLUSH	\$77.97	GLENWOOD HILLS	\$36.00	GRACEFUL VINES	\$32.00	GROOVY PLAID	\$24.97
GALAXY STRIPE	\$27.97	GEO SHAPE	\$48.00	GLIDE ON	\$49.00	GRADIENT	\$19.00	GROVE VALLEY	\$48.00
GALBRAITH	\$73.97	GEO STRIPE	\$37.97	GLIMMER EFFECT	\$38.00	GRAFFANINO	\$25.97	GROWING BUDS	\$74.00
GALENO SQUARE	\$74.00	GEODE	\$94.00	GLIMMER POINT	\$51.97	GRAFFITI RINGS	\$38.97	GROWING STRONG	\$34.00
GALETON	\$77.97	GEOMETRIC SILK	\$78.00	GLIMMER SEQUIN	\$48.00	GRAFORD	\$46.00	GROWING WILD	\$74.00
GALIMATIAS	\$40.00	GEOMETRIC WAY	\$32.00	GLIMMER SPOTS	\$82.00	GRAINY ROAD	\$44.00	GUARDRAIL	\$38.00

WHOLESALE TRADE PRICE LIST
800.333.3777

ROBERT ALLEN accepts MasterCard, Visa® and American Express

ROBERT ALLEN

PATTERN	PRICE	PATTERN	PRICE	PATTERN	PRICE	PATTERN	PRICE	PATTERN	PRICE
GUEST LIST	\$50.00	HARTFORD	\$87.97	HIDARKA	\$79.00	HOUNDSVILLE	\$62.00	IMPRESS	\$54.97
GUIDELINES	\$55.97	HARTWELL FLEUR	\$75.00	HIDDEN HILLS	\$67.97	HOWAYEK	\$54.00	IMPRESSIVE	\$92.00
GUINEVER	\$81.97	HARVARD SQUARE	\$78.97	HIDDEN MIST	\$26.00	HOWLAND	\$75.97	IMPRESSIVE DOT	\$32.00
GULF STREAM	\$64.97	HARVEST HOME	\$62.00	HIDDEN SQUARES	\$72.00	HUBBARD	\$25.00	IMPREZZA	\$59.00
GULZAR	\$77.97	HARVEST MELT	\$71.97	HIDDEN STRIPE	\$26.00	HUCKNALL	\$65.97	IMPRINT ISLE	\$82.00
GUMPTION	\$61.97	HARVEST MOON	\$40.00	HIDDEN WORLD	\$74.00	HUDSON BAY	\$36.00	IN A TRANCE	\$34.00
GUNDA	\$21.97	HARVEST WEAVE	\$61.97	HIDEAWAY	\$75.97	HUDSON FAMILY	\$55.00	IN HER SHOES	\$42.00
GWENEVERE	\$65.00	HARWICH PORT	\$40.00	HIGH LO STRIPE	\$56.00	HUDSON PLAID	\$30.00	IN LINE	\$34.97
GWINETT LANE	\$82.00	HATTORI	\$47.97	HIGH PATH	\$52.00	HUDSON STRIPE	\$32.00	IN SHAPE	\$38.00
GYLLENHAAL	\$58.00	HAUSMAN	\$51.97	HIGH POST	\$38.00	HUGGLER	\$66.00	IN THE GROOVE	\$76.00
GYPSY BANDS	\$42.00	HAVIANA	\$134.00	HIGH PROFILE	\$80.00	HUGO	\$54.97	IN THE PARK	\$53.97
GYPSY DANCER	\$18.00	HAWAIIAN FLOWER	\$71.97	HIGH RUN	\$34.00	HUILA	\$74.00	IN THE ROUGH	\$82.00
GYROSCOPE	\$82.00	HAWK COVE	\$52.00	HIGH TEA	\$41.97	HULA HOOPS	\$42.00	IN THE ROUND	\$61.97
GYVES	\$73.97	HAYWORTH	\$64.97	HIGH WAVES	\$48.00	HUMBERSIDE	\$84.00	IN TRANSIT	\$47.97
HABERKORN	\$57.97	HAZEL CREST	\$48.00	HIGH WIRE	\$100.00	HUMBOLDT PLAID	\$26.00	INABA	\$44.00
HACKNEY	\$79.00	HAZY DAMASK	\$40.00	HIGHLAND FLING	\$59.00	HUNTERS PURSE	\$66.00	INBOX	\$48.00
HADDINGTON	\$44.00	HAZY DAY	\$34.00	HIGHMEADOW	\$71.97	HUNTING ED	\$37.97	INCLINATION	\$46.00
HADDON HALL	\$68.00	HAZY DIAMOND	\$44.00	HIGHRISE	\$73.97	HUNTINGTON AVE	\$25.00	INDENTATION	\$56.00
HADLEY	\$45.97	HAZY STRIPES	\$43.97	HIGHWAY	\$42.00	HUTCHERLEIGH	\$32.00	INDIAN PATH	\$59.00
HAIL STONES	\$34.00	HEADSAIL	\$56.00	HILBERT ESTATE	\$66.00	HUTTLESTON	\$90.00	INDIAN STRIPE	\$32.00
HAILEYS BEAM	\$74.00	HEARTEN	\$52.00	HILLSMERE	\$53.97	HYALITE	\$52.00	INDIANOLA	\$57.97
HAILEYS PATH	\$42.00	HEARTS GALORE	\$59.00	HILLSTEAD	\$40.97	HYBRID FOLIAGE	\$146.00	INDULGE	\$81.97
HAKIMO	\$93.97	HEARTWARMING	\$20.00	HILO BEAUTY	\$25.00	HYDERBAD	\$58.00	INESCAPABLE	\$44.97
HALIFAX RANGE	\$64.00	HEARTWOOD	\$32.00	HILTZ	\$30.00	HYDRA	\$24.00	INEVITABLE	\$57.97
HALLIDEN	\$61.97	HEATHER BREEZE	\$38.00	HINKLY	\$63.97	HYLIA	\$32.00	INFAMOUS	\$52.00
HALO EMBROIDER	\$55.00	HEAVEN SENT	\$55.00	HOCKENBERRY	\$31.97	HYPERSLIDE	\$30.00	INFINEON	\$33.97
HALTOM CITY	\$24.00	HEAVENLY	\$45.00	HODGEPODGE	\$42.97	HYPOLITA	\$54.97	INFINITE LOVE	\$42.00
HALTWHISTLE	\$77.97	HEAVENLY SOFT	\$44.00	HOKENA	\$78.97	HYPOTHETICAL	\$34.00	INFUSER	\$62.00
HAMANDIR	\$52.00	HEAVENS LIGHT	\$28.00	HOLIDAY PARTY	\$40.00	HYROGLIPIC	\$61.97	INGONISH	\$56.00
HAMBLE	\$46.00	HEAVY FLANNEL	\$9.00	HOLIDAY STRIPE	\$28.00	HYRULE CASTLE	\$42.00	INGRASSIA	\$43.97
HAMBO	\$32.00	HEDGE MAZE	\$32.00	HOLLAND PARK	\$32.00	HYSPERIA	\$65.97	INKLING	\$74.00
HAMERSTROM	\$69.97	HEDGES FALLS	\$54.97	HOLLIS WOODS	\$35.97	HYSTERIUM	\$75.97	INLAY	\$65.97
HAMMER STRIPE	\$32.00	HEENEY STRIPE	\$23.97	HOLLISTER	\$77.97	IALEMO	\$35.97	INLINE SQUARES	\$48.00
HAMMOCK TIME	\$49.00	HEIGHTEN	\$51.97	HOLLY BROOK	\$22.00	IALISO	\$77.97	INMAN SQUARE	\$38.00
HAMMONDSPORT	\$31.97	HEIRLOOM LINEN	\$55.00	HOLLY GROVE	\$52.00	IBRIS	\$29.97	INN ESSENCE	\$30.00
HAMPTON COURT	\$25.00	HELENE	\$25.00	HOLOGRAPH	\$59.00	ICARIO	\$161.97	INNATE	\$58.00
HAND KNOTTED	\$72.00	HELENE STRIPE	\$24.00	HOMBRE	\$52.00	ICE CUBES	\$71.97	INNER CIRCLE	\$52.00
HAND TAILORED	\$108.00	HELIONA	\$51.97	HOME AT LAST	\$19.00	ICE DANCER	\$61.97	INNER DIAMONDS	\$39.00
HANDIWORK	\$75.00	HELIOS PLAID	\$50.00	HOMEPORT	\$41.97	ICEFALL	\$56.00	INNER EYE	\$48.00
HANEWICH	\$73.97	HELIOTROPE	\$63.97	HOMETOWN	\$58.00	ICHI NI SAN	\$23.97	INNER GEO	\$24.00
HANJIN	\$56.00	HELIX WONDER	\$42.00	HOMMAGE	\$44.00	IDAHO	\$24.00	INNER LINES	\$32.00
HANKIN	\$62.00	HENDRA PARK	\$23.97	HONEY BEES	\$54.97	IDALAIN	\$40.00	INNER RING	\$42.00
HANNAH ROAD	\$48.00	HENRY LANE	\$67.97	HONEY HARBOR	\$28.00	IDEAL MIX	\$37.97	INNERVE	\$104.00
HANNAHVILLE	\$58.00	HERA	\$25.97	HONEY HILL	\$47.97	IDEAL WEAVE	\$68.00	INSIGHTFUL	\$100.00
HANOKO STRIPE	\$34.00	HERBER SPRINGS	\$25.97	HONEYCOMB LINEN	\$61.97	IDOIA	\$86.00	INSPIRING	\$70.00
HANRAHAN	\$71.97	HERE AND NOW	\$29.00	HOOK AROUND	\$48.00	IERA	\$47.97	INSTANT LIFT	\$45.00
HANSBRICK	\$66.00	HEREFORD	\$46.00	HOOPLA	\$69.97	IGNITE	\$78.00	INTEGRITY	\$52.97
HANWOOD	\$34.00	HERITAGE COURT	\$38.97	HOOTENANNY	\$67.97	IKAT BLOCKS	\$55.00	INTENT	\$70.00
HAPPY BEAUTY	\$49.00	HERRING STRIPE	\$24.00	HOP ON	\$29.00	IKAT CROSS	\$52.00	INTERCHANGE	\$120.97
HAPPY HOUR	\$50.00	HERRING WAY	\$64.00	HOPSACK	\$35.00	IKAT SATIN	\$39.00	INTERIM	\$28.00
HARBOR BREEZE	\$49.00	HESPERIA	\$62.00	HORBLIT RANCH	\$55.00	IKAT SQUARES	\$50.00	INTERIOR LOOP	\$52.00
HARBOR INN	\$36.00	HESTIA	\$52.00	HORIZON	\$55.00	IKAT STRIPE BK	\$22.95	INTERLINING	\$6.00
HARDISON	\$54.97	HEX CONNECT	\$44.00	HORNELL	\$29.97	IMELDA	\$40.00	INTERLOCK	\$52.00
HARES HILL	\$45.00	HEXAGON	\$36.00	HOSHI	\$18.97	IMITABLE	\$28.00	INTERMINGLE	\$75.00
HARLEQUIN LEAF	\$58.00	HEXAGON LINKS	\$45.00	HOSP BUILDING	\$81.97	IMPALA	\$55.00	INTERMIX	\$68.00
HARMONIZE	\$66.00	HEXAGON RIB	\$44.00	HOT SPRINGS	\$83.97	IMPATH	\$52.00	INTERPRETATION	\$47.97
HARRISVILLE	\$61.97	HEXLEY	\$11.97	HOT TOPICS	\$58.00	IMPECCABLE	\$77.97	INTERSECTION	\$42.00
HARROGATE	\$69.97	HICKORY HILL	\$57.97	HOUNDSTOOTH BR	\$32.00	IMPERIAL PLAID	\$40.00	INTERSTELLAR	\$40.00

WHOLESALE TRADE PRICE LIST
800.333.3777

ROBERT ALLEN accepts MasterCard, Visa® and American Express

ROBERT ALLEN

PATTERN	PRICE	PATTERN	PRICE	PATTERN	PRICE	PATTERN	PRICE	PATTERN	PRICE
INTERTWINED	\$52.00	JAMIE LYNN	\$62.00	JOY RANGE	\$58.00	KATIUSKA	\$66.00	KIMONO	\$50.00
INTERWOVEN	\$172.00	JARA	\$81.97	JOYFUL FEELING	\$34.00	KATONAH	\$58.00	KIND KELLY	\$28.00
INTERWOVEN DOT	\$28.00	JARMILA	\$32.00	JOYFUL MORNING	\$64.97	KATRONA	\$48.00	KINETIC	\$77.97
INTOXICATING	\$56.00	JARVINA	\$77.97	JOYFUL NOTES	\$26.00	KATYS ROOM	\$30.00	KING HENRY	\$75.97
INTRIGUING	\$93.97	JASMINE FLORAL	\$88.00	JOZLYNN	\$78.00	KAUAI	\$73.97	KING LOUIE	\$51.97
INTUITION	\$40.97	JASON WAY	\$44.00	JUANAMBU	\$36.00	KAVERI B/OFR54	\$9.00	KING PHILIP	\$63.97
INVIGORATE	\$53.97	JAY STRIPE	\$32.00	JUBA	\$34.00	KAYS PICNIC	\$48.00	KINGS CANYON	\$25.00
IRISA	\$93.97	JAYA	\$32.97	JUBERRI	\$42.00	KAZAK	\$20.00	KINGS PORT	\$61.97
IRMA	\$86.00	JAYACHIN	\$31.97	JUBILANT	\$75.97	KAZAK PLAID	\$20.00	KINGS ROAD	\$44.00
IRO	\$27.97	JAYANTI	\$65.00	JULIA	\$57.97	KAZAK PLEAT	\$33.97	KINGS STRIPE	\$53.97
IRONWORK	\$73.97	JAYLENE	\$52.00	JULIETTE	\$51.97	KAZAK STRIPE	\$20.00	KINGS WALK	\$68.00
IRRESISTIBLE	\$57.97	JAZZ AGE	\$59.00	JUMBO LEAVES	\$30.00	KAZBEK	\$34.00	KINGSBOROUGH	\$36.00
ISABELLE	\$51.97	JAZZIE	\$52.00	JUMP DRIVE	\$45.00	KEA	\$40.00	KINGSBRIDGE	\$22.00
ISADORA VELVET	\$48.00	JEAN LOOK	\$94.00	JUMP ROPE	\$30.00	KEARNEY	\$42.00	KINGSCOTE	\$41.97
ISAIHAH	\$29.97	JEANE	\$75.97	JUMP SHOT	\$34.00	KEARSTEAD	\$56.00	KINGSCROSS	\$42.97
ISELIN PARK	\$84.00	JEDIDIAH	\$54.97	JUMPING JACKS	\$55.00	KEEP MOVIN	\$49.00	KINGSGATE	\$62.00
ISELLE	\$41.97	JEFFREY	\$48.00	JUNE	\$93.97	KEIKO GARDEN	\$47.97	KINGSMILL	\$42.00
ISENBURG	\$61.97	JELENA	\$66.00	JUNE DAY	\$52.00	KELBY	\$54.97	KINGSTON SHORE	\$34.00
ISHTAR	\$36.00	JENNA MARIE	\$30.00	JUNE DIAMOND	\$48.00	KELLETT	\$34.00	KINNON	\$54.97
ISLAND FLOWER	\$34.00	JENNIE STRIPE	\$26.00	JUNGALOW	\$70.00	KELLY	\$34.00	KIOKO STRIPE	\$61.97
ISLAND GLOW	\$48.00	JENZ	\$28.00	JUNGLE FERNS	\$62.00	KELMSCOTT	\$38.00	KIRISTA	\$147.97
ISLAND PAISLEY	\$38.00	JEOPARDY	\$31.97	JUNGLE LAND	\$39.97	KELTIC	\$56.00	KISS KISS	\$34.00
ISLAND PETALS	\$28.00	JERMAINE	\$74.97	JUNGLE QUEST	\$52.00	KELTIC CHARM	\$66.00	KISS OF DESIGN	\$33.97
ISLAND STRIPE	\$35.00	JEROME	\$54.97	JUNGLE ROAD	\$74.00	KELTIC GRACE	\$19.00	KITCHEN LINEN	\$47.97
ISLAND TIME	\$22.00	JERRY POINT	\$40.00	JURJUJY	\$58.00	KEMPSFORD	\$69.97	KITSILANO	\$62.00
ISLE OF CAPRI	\$62.00	JESSICA LANE	\$39.00	JURYS	\$40.00	KEMPTON MANOR	\$61.97	KIVITEL	\$49.00
ISLE ROYALE	\$62.00	JESSICA WAY	\$29.97	JUST BECAUSE	\$54.97	KENDALL SQUARE	\$25.00	KLAUSON	\$41.00
ISOBEL UNION	\$58.00	JESSUP	\$73.97	JUST CHIC	\$61.97	KENMORE SQUARE	\$58.00	KNAPPTON	\$71.97
ISOLA PRIVATA	\$108.00	JESTERS CLOTH	\$32.00	JUST OUT	\$58.00	KENNEBAGO	\$70.00	KNIGHTLEY	\$51.97
ISOSCELES	\$44.00	JET SET	\$48.00	JUST PERFECT	\$25.00	KENNEDALE	\$79.00	KNIGHTSBRIDGE	\$42.00
ISOTOPE	\$148.00	JETSON SPHERES	\$52.00	JUSTY	\$52.00	KENNYBROOK	\$53.97	KNITTLES	\$62.00
ISSIDE	\$31.97	JEU DE BALLE	\$88.00	JUTE CHENILLE	\$54.00	KENSINGTON	\$161.97	KNITTY GRITTY	\$38.00
ISTRO	\$124.97	JEWELLED CORD	\$48.00	JUTE TAPE	\$20.00	KENT HILL	\$62.00	KNOT ALONG	\$54.00
ITILO	\$87.97	JEZABEL	\$62.00	JUXTAPOSE	\$77.97	KENTUCKY FIELD	\$32.00	KNOTS	\$62.00
ITS ELECTRIC	\$66.00	JIMENA	\$68.00	KABLOOM	\$69.97	KENWAY STRIPE	\$62.00	KNOTTED LINES	\$32.00
ITS MY LINE	\$43.97	JIMMU	\$57.97	KABUKI	\$34.00	KENWORTHY	\$52.00	KNOTTED POLE	\$95.97
IVERSON	\$34.00	JITTERBUG	\$69.97	KADAM	\$73.97	KENYA	\$62.00	KNOTTED SHEERS	\$58.00
IVORY COAST	\$42.00	JOANELLE	\$30.00	KAI	\$50.97	KENYA BAND	\$32.00	KNOWLES	\$31.97
IVY ISLE	\$74.00	JOCULAR	\$51.97	KAIROTIC	\$35.97	KERALA	\$44.00	KOINONIA	\$65.97
IZMAR	\$77.97	JOE LEE STRIPE	\$55.00	KAL PLAID	\$22.00	KERI ANN	\$40.00	KOLANA ROCK	\$38.00
JABLOW	\$21.97	JOEY	\$42.00	KAL STRIPE	\$25.00	KERRYKELL	\$79.00	KONKAN	\$63.97
JACAMAR	\$55.97	JOHNSONVILLE	\$42.00	KALAMKARI	\$42.00	KERSEY BOUCLE	\$52.00	KONYA	\$66.00
JACINTO	\$72.00	JOINED CIRCLES	\$34.00	KALEKO INN	\$66.00	KESHCARRIGAN	\$55.00	KORINTHOS	\$26.00
JACKS PAD	\$42.00	JOINT DIAMONDS	\$50.00	KALEM	\$63.97	KEXBY PLAID	\$28.00	KOROWSKI	\$54.97
JACKSBORO	\$34.00	JOJO LINE	\$49.00	KALIN	\$46.00	KEY CORA	\$35.00	KOSOFF	\$32.00
JACKSON SQUARE	\$30.00	JOLARIAN	\$67.97	KAMENSTEIN	\$58.00	KEYHOLE	\$22.00	KOTZITKY	\$74.00
JACKSON STRIPE	\$62.00	JOLICOEUR	\$67.97	KANAKAREDES	\$88.00	KICKAPOO	\$44.00	KOUSA	\$29.97
JACOBELLIS	\$68.00	JONES CREEK	\$42.00	KAORI	\$81.97	KIDS FUN	\$67.97	KUDZO	\$48.97
JACOBS	\$68.97	JONI	\$23.97	KAPULAN	\$69.97	KIDSKIN	\$30.00	KUPANG	\$58.00
JACOBS LADDER	\$77.97	JORUNN	\$25.00	KARA MARIE	\$68.00	KILCREA	\$32.00	KYLE JAMES	\$58.00
JACOBY	\$47.97	JOSETTE	\$51.97	KARA STRIPE	\$49.00	KILLIAN	\$48.00	KYLES ROAD	\$58.00
JADEN	\$19.00	JOSHUA TREE	\$26.00	KARA WAY	\$94.97	KILRONAN	\$45.00	KYLIA GLEN	\$74.00
JAGGARED	\$52.00	JOSIE PLAID	\$46.00	KARASTAN VASE	\$74.00	KILROY	\$74.97	KYRIELL	\$177.97
JAGGED EDGE	\$19.95	JOSIE STRIPE	\$46.00	KARELIS	\$45.00	KILRUSH	\$26.00	LA CIVITA	\$57.97
JAISALMER WAY	\$58.00	JOTA	\$34.00	KARNAK	\$42.00	KILRUSH II	\$25.00	LA FANU	\$20.00
JAM SESSION	\$42.00	JOVIAN	\$79.97	KASAI	\$188.97	KILSPINDIE	\$38.00	LA FONTAINE	\$92.00
JAMAICA	\$26.00	JOY OF MY LIFE	\$36.00	KASAI CLOTH	\$112.00	KILTIES	\$24.00	LA MURINA	\$38.00
JAMESPORT	\$43.97	JOY OF NATURE	\$56.00	KATIA	\$71.97	KIM CRACKLE	\$73.97	LA PALMA	\$48.00

WHOLESALE TRADE PRICE LIST
800.333.3777

ROBERT ALLEN accepts MasterCard, Visa® and American Express

ROBERT ALLEN

PATTERN	PRICE	PATTERN	PRICE	PATTERN	PRICE	PATTERN	PRICE	PATTERN	PRICE
LABRADOR	\$23.97	LAVANDISH	\$110.00	LEIDEN B/O 54	\$8.00	LIBRARY ROUCHE	\$22.00	LINSEEKER	\$75.97
LABRINTO	\$40.00	LAVERY	\$74.00	LEIDEN B/OFR54	\$9.00	LIBRARY RUFFLE	\$73.97	LINESIDE	\$42.00
LACAVA	\$46.00	LAVISH PAISLEY	\$51.97	LEIGHTON	\$30.00	LIBRARY STRIPE	\$18.00	LINGOTTO	\$57.97
LACE FANTASY	\$62.00	LAVISH STRIPES	\$42.00	LEISURE TIME	\$55.00	LIBRARY TAPE	\$36.00	LINK	\$74.00
LACEBARK	\$45.97	LAVISHING	\$24.00	LEISURELAND	\$33.97	LIBRARY TASSEL	\$55.00	LINK INFLUENCE	\$75.00
LACHLAN	\$50.00	LAVISHLY	\$52.00	LEISURELY	\$42.00	LIBRARY TIEBACK	\$89.97	LINK UP	\$52.00
LACY BLOOMS	\$62.00	LAVONNE	\$69.97	LEITA	\$37.97	LIBRARY TWEED	\$19.00	LINKAGE	\$45.97
LADDER BRIDGE	\$70.00	LAWFORD STRIPE	\$24.00	LEITRIM	\$40.97	LICINI	\$35.97	LINKED GEO	\$55.00
LADDERBACK	\$79.00	LAWN CHAIR	\$50.00	LEKOW	\$25.00	LIFESAVER	\$44.00	LINKED SHAPES	\$35.00
LADIES CHOICE	\$58.00	LAWRENCEBURG	\$53.97	LELAND	\$26.00	LIFTED LINES	\$48.00	LINKED TUBES	\$42.00
LADY DAY	\$26.00	LAYERED BANDS	\$36.00	LENIRE	\$73.97	LIFTED LOOK	\$52.00	LINNEAN	\$32.00
LADY TARA	\$48.00	LAYERED DOTS	\$56.00	LEOCADIA	\$68.00	LIFTOFF	\$38.00	LINO VELVET	\$80.00
LADYLOVE	\$54.97	LAYERS	\$54.97	LEONA FLAIR	\$74.00	LIGHT HEARTED	\$47.97	LIP TWIST	\$19.00
LAGERFELD	\$58.00	LAZY CABANA	\$78.00	LEONA PRINT	\$25.00	LIGHT N BRIGHT	\$25.00	LIQUID GOLD	\$65.00
LAGONDA	\$59.00	LAZY STREET	\$40.00	LEONARDO	\$22.00	LIGHT SPRAY	\$68.97	LISBETH FLORAL	\$54.00
LAIRD	\$38.97	LE KEY	\$68.00	LEONARDS POINT	\$71.97	LIGHT STRIE	\$24.00	LISBON PAISLEY	\$32.00
LAKE GEORGE	\$34.00	LE MISTRAL	\$42.00	LEOPARD FLOCK	\$28.97	LIGHTEN UP	\$25.00	LISCANNOR	\$52.00
LAKELAND	\$45.00	LEADING EDGE	\$39.00	LEOPARD PATH	\$40.00	LIGHTHOUSES	\$75.97	LITKA	\$37.97
LAKOTA WOMAN	\$74.00	LEAF CANOPY	\$169.00	LEOTI	\$52.00	LIGONIER	\$36.00	LITTLE BROOKE	\$30.00
LALLYBROCH	\$52.00	LEAF CHAIN	\$72.00	LESHAY	\$36.00	LIGURIA	\$21.97	LITTLE DARLING	\$19.00
LAMARCHE	\$59.00	LEAF FOLIAGE	\$37.97	LETS SCROLL	\$69.97	LILASHLEY	\$40.00	LITTLE DOTS	\$28.00
LAMBEAU	\$42.00	LEAF GALLERY	\$37.97	LETTERFRACK	\$32.00	LIL BRIDGETTE	\$26.00	LITTLE LINES	\$56.00
LAMBIEL	\$82.00	LEAF GATHERING	\$58.00	LETTERKENNY	\$58.00	LILLEHAMMER	\$32.00	LITTLE OCTAGON	\$56.00
LAMPS ALOT	\$73.97	LEAF GLOW	\$38.00	LETTERMULLEN	\$38.00	LILTING	\$75.00	LITTLE ROCK	\$38.97
LANDMARK	\$46.00	LEAF LINE	\$50.97	LEVEL OPULENCE	\$54.00	LILY	\$77.97	LITTLE SHOWOFF	\$36.00
LANDSCAPE VIEW	\$80.00	LEAF NOUVEAU	\$19.95	LEVEL PLAINS	\$20.00	LIMEIRA	\$38.00	LITTLE SPACES	\$52.00
LANE BLOCKING	\$71.97	LEAF PILE	\$46.00	LEVITOWN	\$28.00	LIMERICK	\$35.97	LITTLE STARS	\$45.00
LANE MIXER	\$67.97	LEAF POD	\$58.00	LEWIS RANGE	\$32.00	LIMITED EDITION	\$57.97	LITTLE TURTLES	\$61.97
LANES	\$26.00	LEAF POINT	\$25.00	LEWISPORT	\$47.97	LIMITLESS	\$72.00	LIVING LIFE	\$47.97
LANGSTROM	\$32.00	LEAF SEASON	\$46.00	LEYRITZ	\$42.00	LIMOGES	\$42.00	LIVING NATIONS	\$74.00
LANTERN LANE	\$55.00	LEAF SKETCHES	\$25.97	LIBERATION	\$26.00	LINARDI	\$17.97	LIVING SIMPLY	\$19.00
LAPIERRE	\$33.97	LEAF SPINNER	\$32.00	LIBERTY LANE	\$48.00	LINARIA	\$157.97	LIZA	\$35.97
LAPORTA	\$53.97	LEAF SPIRALS	\$48.00	LIBERTY LEAF	\$63.97	LINDEN PARK	\$19.95	LOCH BAN	\$75.00
LARGE BUDS	\$95.00	LEAF STRIE	\$42.00	LIBERTY STRIPE	\$62.00	LINDENHURST	\$67.97	LOCKED SQUARES	\$37.97
LARGE CHECK	\$64.00	LEAF VINE	\$64.00	LIBRARY BASKET	\$18.97	LINDY HOP	\$45.00	LOCKING DOTS	\$50.00
LARGE PETALS	\$62.00	LEAFTOWN	\$48.00	LIBRARY BAUBLE	\$58.00	LINE CHANGE	\$59.00	LOCOMOTION	\$38.97
LARIVIERE	\$62.00	LEAFY ACCENT	\$57.97	LIBRARY BEAD	\$70.00	LINE COUNT	\$66.00	LOFTY THOUGHTS	\$46.00
LARNE	\$44.97	LEAFY CABANA	\$49.00	LIBRARY BRAID	\$20.00	LINE FLOWER	\$58.00	LOG CABIN	\$60.00
LAROCQUE	\$116.00	LEAFY DAWDLE	\$66.00	LIBRARY BRUSH	\$19.00	LINE PLAID	\$66.00	LOGGINS	\$34.00
LAS OLAS	\$66.00	LEAFY HARMONY	\$72.00	LIBRARY BUL LG	\$68.97	LINE STITCH	\$36.00	LOGUE LEGACY	\$42.00
LASER LATTICE	\$46.00	LEAFY HIDEAWAY	\$34.00	LIBRARY BUL SM	\$37.97	LINEAL LANES	\$15.00	LOMOND AVENUE	\$81.97
LASHIO	\$53.97	LEAFY LOOK	\$49.00	LIBRARY CHAIR	\$37.97	LINEAR CIRCULO	\$52.00	LONBORG	\$50.00
LAST DAY	\$38.00	LEAFY STITCH	\$84.00	LIBRARY CHECK	\$16.00	LINEAR LINES	\$52.00	LONDON EYE	\$19.95
LAST EMPIRE	\$44.00	LEAFY TREND	\$45.00	LIBRARY CORD	\$8.00	LINEAR STITCH	\$74.00	LONDON SQUARES	\$30.00
LAST WAVE	\$71.97	LEATHER CORD	\$14.00	LIBRARY EYELASH	\$28.00	LINEAR TEXTURE	\$38.00	LONDON TOWN	\$41.97
LASTING LINES	\$34.00	LEATHER DUO	\$53.97	LIBRARY FRINGE	\$28.00	LINED COLUMNS	\$38.97	LONDRA	\$48.00
LATER GATOR	\$52.00	LEATHER TAPE	\$16.00	LIBRARY GIMP	\$16.00	LINED DIAMONDS	\$34.00	LONE OAK	\$38.00
LATEST LOOK	\$48.00	LEAVES ABOUND	\$69.97	LIBRARY KEY	\$29.97	LINED PATH	\$28.00	LONG GONE	\$50.00
LATTICE BAMBK	\$22.95	LEAVES GALORE	\$52.00	LIBRARY LOOP	\$30.00	LINED ROAD	\$34.00	LONG GROVE	\$75.97
LATTICE GRID	\$58.00	LEAVITT	\$47.00	LIBRARY MODERN	\$41.97	LINED UP	\$59.00	LONG LINE	\$20.00
LATTICE TASSELS	\$40.00	LECHMERE	\$80.00	LIBRARY PLEAT	\$28.00	LINEN CANVAS	\$46.00	LONG RANGE	\$20.00
LAUGH LINES	\$64.00	LECOMPTE	\$73.97	LIBRARY R BL L	\$70.00	LINEN DART BAND	\$30.00	LONG ROWS	\$25.00
LAURALYN	\$62.00	LECREOLE	\$32.00	LIBRARY R BL S	\$40.00	LINEN IMAGE	\$18.00	LONGDALE	\$61.97
LAUREL	\$44.97	LEDA	\$42.00	LIBRARY R CHAIR	\$40.00	LINEN MELODY	\$68.97	LONGEST YARD	\$42.00
LAUREL GROVE	\$28.00	LEDGER	\$42.97	LIBRARY R KEY	\$36.00	LINEN PAISLEY	\$34.00	LONGEVITY	\$57.97
LAUREN	\$48.00	LEDREW	\$58.00	LIBRARY R TIEBK	\$99.00	LINES GALORE	\$48.00	LONGFORD	\$67.97
LAUREN FLORAL	\$48.00	LEGANZA	\$28.00	LIBRARY RIBBON	\$19.00	LINES N THINGS	\$69.97	LONGHOLLOW	\$62.00
LAVALAMP	\$61.97	LEHANE	\$45.97	LIBRARY ROPE	\$10.00	LINES WITHIN	\$69.97	LONGITUDE	\$56.00

WHOLESALE TRADE PRICE LIST
800.333.3777

ROBERT ALLEN accepts MasterCard, Visa® and American Express

ROBERT ALLEN

PATTERN	PRICE	PATTERN	PRICE	PATTERN	PRICE	PATTERN	PRICE	PATTERN	PRICE
LONGLANE	\$34.00	LUNAR LANDING	\$44.97	MALHOLTRA	\$56.00	MASARRO	\$81.97	MEAH	\$30.00
LONGLEAF	\$48.97	LUPICA	\$25.00	MALI BAND	\$40.00	MASEPA	\$72.00	MEBANE	\$24.97
LONGMORE	\$48.97	LUREX DIAMONDS	\$45.00	MALIKO BAY	\$26.00	MASHONA	\$29.97	MECHLIN	\$75.00
LONGS PEAK	\$64.00	LUREX LINE	\$31.97	MALLASPINA	\$44.97	MASON	\$26.00	MEDBURY	\$30.00
LONGSTRIPE	\$54.97	LUSCOMB	\$77.97	MALLON	\$52.00	MASSEY	\$52.00	MEDESKI	\$53.97
LONGVIEW	\$52.00	LUSH WAVE	\$69.00	MALTONI	\$19.97	MASTER LOCK	\$30.00	MEDIALUNA	\$42.00
LOOK BACK	\$19.95	LUSMILA	\$75.00	MALUHIA	\$47.97	MASTERCARD	\$40.00	MEDICI MARBLE	\$70.00
LOOKEBA	\$62.00	LUSTER MESH	\$22.00	MAMMA MIA	\$24.00	MASTERCARD II	\$48.00	MEDIO CIRCULO	\$62.00
LOOKING GLASS	\$45.00	LUSTRE SHEEN	\$19.00	MAMMOTH STAR	\$44.00	MASTERPIECE	\$25.00	MEETING PLACE	\$54.00
LOOMIS	\$76.00	LUSTRE VELVET	\$80.00	MAMMYS GARDEN	\$44.00	MASTOLONI	\$64.00	MEISSNER	\$46.00
LOOP AROUND	\$55.97	LUSTROUS	\$65.00	MANCUSO	\$70.00	MASTRIA	\$58.00	MELA	\$15.97
LOOP BRAID	\$40.00	LUSTROUS ROWS	\$24.00	MANDISA FLEUR	\$23.97	MATARESE	\$44.97	MELANGE STRIPE	\$48.00
LOOP FRINGE	\$40.00	LUTEA	\$27.97	MANERVA	\$67.97	MATCH SET	\$19.95	MELANGE TWEED	\$50.00
LOOP SCROLL	\$19.95	LUV	\$58.00	MANIZALES	\$48.00	MATCH STICKS	\$70.00	MELCHIOR	\$69.97
LOOPING LINES	\$62.00	LUXE BROCADE	\$58.97	MANOR TEATIME	\$80.00	MATHESON	\$34.00	MELLEE	\$73.97
LOOPY SHEER	\$25.00	LUXE LARIAT	\$37.97	MANORLY	\$66.00	MATISSE FLORAL	\$45.00	MELLOW MOOD	\$35.97
LOOSE LEAVES	\$26.00	LUXE LOOK	\$38.00	MANSFORD	\$22.00	MATRIX	\$38.97	MELLOW STRIPE	\$42.00
LORAIN DK	\$25.00	LUXESUEDE	\$98.97	MANVEL	\$19.95	MATSUE	\$75.00	MELLOW TONE	\$42.00
LORAIN LT	\$21.97	LUXURIOUS LOOK	\$26.00	MANY DIAMONDS	\$39.00	MATTE SHIMMER	\$22.00	MELODY HILL	\$47.97
LORALEE	\$23.97	LUXURIOUS SILK	\$67.97	MANY FACETS	\$140.00	MATTIOLI	\$45.00	MEMORABLE	\$69.97
LORE CHINTZED	\$31.97	LUXURY COMFORT	\$82.00	MANY LEAVES	\$48.00	MATTISON	\$32.00	MEMORIES	\$37.97
LORI JEAN	\$37.97	LUXURY DUPIONI	\$18.00	MANY LINES	\$62.00	MATTOON	\$75.97	MENDOCINO	\$46.00
LORING PARK	\$45.00	LUXURY LINES	\$42.00	MANY ROADS	\$52.00	MATUTINAL	\$54.00	MENDON STRIE	\$32.00
LOS CANARIOS	\$50.00	LUYNES	\$71.97	MANY STRIPES	\$42.00	MAUMCROSS	\$62.00	MEREL	\$25.00
LOS PINOS	\$44.00	LUZERNE B/O FR	\$9.00	MANZANAR	\$42.00	MAURIZIO	\$65.00	MERLANA	\$22.00
LOST GARDEN	\$75.97	LYDIA	\$19.97	MAPLE CREEK	\$61.97	MAXAZRIA	\$52.00	MERLOT WAY	\$42.00
LOST PATH	\$46.00	LYFORD	\$30.00	MAPLE GROVE	\$87.97	MAXIXE	\$42.00	MERONA	\$34.00
LOST SPRINGS	\$68.00	LYGEIA GRACE	\$82.00	MAR	\$37.97	MAXTON STRIPE	\$58.00	MERRY MAZE	\$39.00
LOST WAYS	\$34.00	LYNDEN	\$19.00	MAR A LAGO	\$113.97	MAY LOVE	\$68.00	MERSHAM	\$25.00
LOST WOODS	\$32.00	LYNN ACRES	\$65.97	MAR VISTA	\$25.00	MAY QUEEN	\$54.97	MESA	\$84.00
LOTANE	\$19.97	LYNNFIELD	\$66.00	MARANZANO	\$75.97	MAYAN MIX	\$56.00	MESA SPARKLE	\$79.00
LOTS OF DOTS	\$52.00	LYSANDRA	\$157.97	MARBLE ARCH	\$50.00	MAYBELLINE	\$97.97	MESA VERDE	\$75.97
LOUISBURG	\$46.00	MAC INNES	\$75.97	MARBLE HOUSE	\$78.00	MAYETTA	\$58.97	MESH LINES	\$36.00
LOVE NOTES	\$73.97	MACARIA	\$44.00	MARBLETON	\$59.00	MAYLEA GARDEN	\$42.00	METAL ALLOY	\$110.00
LOVE SONG	\$30.00	MACASSAR	\$59.00	MARCELLE	\$27.97	MAZE ALONG	\$58.00	METAL LUSTRE	\$25.97
LOVE VALLEY	\$36.00	MACKINAW	\$66.00	MARCHETTO	\$54.97	MAZE AVENUE	\$54.00	METAL LUXE	\$40.00
LOVELY LINEN	\$23.97	MACROOM	\$70.00	MARCHING ALONG	\$46.00	MAZE GAME	\$24.00	METAL WEAVE	\$58.00
LOVELY PENDANT	\$51.97	MACS PRINT	\$42.00	MARCHLINE	\$39.00	MAZE MATRIX	\$94.00	METALLIC GEMS	\$72.00
LOVELY QUILT	\$38.00	MADELINE	\$88.97	MARCO ISLAND	\$38.00	MAZE PATH	\$76.00	METALLIC HAZE	\$118.00
LOVESEAT	\$52.00	MADERNO	\$88.97	MARGARITAVILLE	\$45.00	MAZE PLAY	\$64.00	METALLIC LEAF	\$34.00
LOWICK	\$65.97	MADISON DAMASK	\$52.00	MARGOT	\$28.00	MAZE SOLID	\$29.00	METALLIC RAIN	\$122.00
LUCARDO	\$51.97	MADISONVILLE	\$59.00	MARINA DOT	\$49.00	MAZE TRAP	\$22.00	METALLIC SHINE	\$67.97
LUCID SKY	\$54.00	MADRAS	\$69.00	MARINE LIFE	\$77.97	MAZE	\$44.97	METALLIUM	\$51.97
LUCINDA STRIPE	\$33.97	MADRUGADA	\$62.00	MARIN WOOD	\$77.97	MCALOON	\$48.00	METAPHYSICAL	\$38.00
LUCKY PEONY	\$22.00	MAGGIE	\$65.97	MARISOL	\$40.00	MCCAMISH	\$47.97	METASEQUOIA	\$54.00
LUCKY PUCKER	\$26.00	MAGIC FLOWERS	\$62.00	MARISOL IKAT	\$75.00	MCGARRITY	\$57.97	METATRON	\$38.00
LUCKY ROAD	\$42.00	MAGICAL	\$33.97	MARKET SQUARE	\$40.00	MCGEARY	\$74.00	METEORS	\$19.95
LUCKY STRIPES	\$52.00	MAGNANIMOUS	\$88.00	MARLO SQUARES	\$38.00	MCGINTY	\$39.00	METICULOUS	\$82.00
LUCY RIBBED	\$28.00	MAGNETISM	\$104.00	MARONEY	\$38.00	MCHENRY	\$67.97	METRICS	\$34.00
LUCY STRIPE	\$25.97	MAGNETIZING	\$82.00	MAROLIS	\$66.00	MCNAMARA BAND	\$75.00	METRO LINES	\$34.00
LUDOVISI	\$39.97	MAGNETO	\$42.00	MARSHALL LANE	\$64.00	MCPHEE	\$66.00	METRO LUXURY	\$24.00
LUDWELL	\$32.00	MAJESTIC COURT	\$93.97	MARSTON MILLS	\$62.00	MCQUAID	\$61.97	METRO MAGIC	\$44.00
LUGO	\$23.97	MAKERS MARK	\$46.00	MARTOCK STRIPE	\$24.00	MEADMORE	\$80.00	METROPOLE	\$78.00
LUMALITE	\$62.00	MALABAR	\$87.97	MARVIN GARDENS	\$61.97	MEADOW GARDEN	\$20.00	MEVITA	\$47.97
LUMIERE	\$53.00	MALAWI	\$71.97	MARY ALICE	\$31.97	MEADOW MARSH	\$48.00	MEXIA	\$58.00
LUMINOUS	\$24.97	MALAWI BAND	\$32.00	MARYELLEN	\$40.00	MEADOW PLACE	\$62.00	MEXICAN RUSH	\$66.00
LUMINOUS STRIE	\$34.00	MALCHANG	\$58.97	MARYWINE	\$32.00	MEADOWLANDS	\$83.97	MIAMI BEAT	\$92.00
LUNA	\$19.97	MALDEN SQUARE	\$59.00	MASALA	\$45.00	MEADOWS END	\$48.97	MIAMI TWIST	\$92.00

WHOLESALE TRADE PRICE LIST
800.333.3777

ROBERT ALLEN accepts MasterCard, Visa® and American Express

ROBERT ALLEN

PATTERN	PRICE	PATTERN	PRICE	PATTERN	PRICE	PATTERN	PRICE	PATTERN	PRICE
MIATA	\$38.00	MIRABELLA	\$76.00	MONROE	\$36.00	MOVEMENT ART	\$65.97	NABBIT	\$32.00
MICHIBA STRIPE	\$58.00	MIRASSOU	\$114.00	MONSOON	\$73.97	MOVING ASIDE	\$62.00	NABILA	\$59.00
MICHIKO	\$65.97	MIRROR DIAMOND	\$47.00	MONTANA	\$51.97	MOVING UP	\$56.00	NAGLE	\$34.00
MICRO DOT	\$57.97	MIRROR EFFECT	\$47.97	MONTANE	\$40.00	MOYCULLEN	\$42.00	NAIYA STRIPE	\$39.00
MICRO STRIPE	\$40.00	MIRROR LAKE	\$42.00	MONTAVIOUS	\$61.97	MOYEN CHECK	\$36.00	NALAPD	\$58.00
MIDDLE CIRCLE	\$47.97	MIRROR PYRAMID	\$115.00	MONTCLAIR	\$33.97	MOYEN STRIPE	\$36.00	NAMESAKE	\$73.97
MIDDLE DAKOTA	\$58.00	MISSION BOX	\$51.97	MONTE HERMOSO	\$31.97	MOYNA	\$34.00	NANDINI	\$42.00
MIDDLE DOT	\$51.97	MISSION SHAKER	\$44.00	MONTECITO	\$67.97	MT KATAHDIN	\$45.00	NAPA DOT	\$56.00
MIDDLE ROAD	\$65.00	MISSON TWEED	\$25.00	MONTENEGRO	\$30.00	MUFFIN	\$52.00	NAPLES	\$91.97
MIDNIGHT CHAT	\$62.00	MISTY FLORAL	\$74.00	MONTEREY PARK	\$23.97	MUIR	\$87.97	NARA	\$35.97
MIDNIGHT SWAY	\$42.00	MISTY HAZE	\$55.00	MONTERIA	\$34.00	MULHERN	\$26.00	NARDONIA HILLS	\$42.00
MIDVICTORIAN	\$32.00	MITAKA	\$56.00	MONTESSORI	\$74.00	MULHOLLAND DR	\$48.00	NARDOZI	\$75.97
MIES	\$25.97	MITZI	\$44.97	MONTEVERDE	\$78.00	MULHOUSE	\$52.00	NARLI	\$29.97
MIGG VELVET	\$55.00	MIX AND MATCH	\$38.00	MONTRICHARD	\$115.97	MULLAGHMORE	\$48.00	NARROW CANAL	\$64.00
MIGNON	\$235.97	MIX IT UP	\$36.97	MOON BEACH	\$46.00	MULLION	\$24.97	NARROW PATH	\$75.00
MIKADO	\$78.97	MIXED LINES	\$58.00	MOON DANCE	\$19.95	MULSANNE	\$42.00	NARROW ROADS	\$45.00
MIKE	\$64.00	MIXED SQUARES	\$66.00	MOON GAZING	\$56.00	MULTI BANDS	\$54.97	NARUTO	\$22.00
MIKER	\$38.00	MIXED STITCH	\$40.00	MOONBEAM	\$42.00	MULTI BRUSH	\$29.97	NASH	\$79.97
MIKIMOTO	\$38.00	MIXED TRACKS	\$65.00	MOONLIGHT	\$67.97	MULTI CHENILLE	\$38.00	NASHUA	\$45.00
MILAN SOLID	\$39.00	MIXED WEAVE	\$32.00	MOONSWAY	\$75.00	MULTI CORD	\$15.97	NASSAU BAY	\$32.00
MILBURY	\$48.00	MIXOLOGY	\$34.00	MOORISH PAVER	\$125.00	MULTI DOTS	\$71.97	NASUTO	\$71.97
MILEATH	\$48.00	MOCCASIN	\$118.00	MOORS VALLEY	\$39.00	MULTI GRAIN	\$70.00	NATCHEZ TRACE	\$19.95
MILL VALLEY	\$61.97	MOCK CROC	\$30.00	MOOSE COUNTRY	\$84.00	MULTI HEXAGON	\$38.00	NATIVE TRAIL	\$74.00
MILLCREEK	\$46.00	MOD REEVES	\$38.00	MOOSE LODGE	\$52.00	MULTI LIP CORD	\$18.97	NATORI	\$68.00
MILLENNIUM	\$65.97	MODANO	\$33.97	MOOSE ON LOOSE	\$52.00	MULTI MOVES	\$40.00	NATURAL BLEND	\$44.00
MILLIBAR	\$52.00	MODERN ARCH	\$35.00	MOOSEHEAD LAKE	\$55.00	MULTI PEARL	\$73.97	NATURAL IMAGE	\$28.00
MILLWOOD	\$25.00	MODERN BEAD	\$22.00	MORA	\$31.97	MULTI PINDOT	\$57.97	NATURAL MUSKET	\$27.00
MILTON LEAF	\$53.97	MODERN BLINDS	\$70.00	MORATTICO	\$73.97	MULTI STITCH	\$28.00	NATURAL SHAPES	\$24.00
MIMI	\$115.97	MODERN BRAID	\$45.00	MORDINI	\$19.00	MULTI TRACK	\$38.97	NATURAL SLUB	\$22.00
MINEHEAD	\$61.97	MODERN CORAL	\$55.00	MORE DIAMONDS	\$42.00	MULTI TWIST 4"	\$31.97	NATURAL WEAVE	\$72.00
MINELEM	\$67.97	MODERN CORD	\$48.97	MORELOS	\$29.97	MULTI TWIST 8"	\$53.97	NATURAL WONDER	\$77.97
MINELLI	\$39.00	MODERN CURVE	\$50.00	MORGAN MARIE	\$30.00	MULTITASKING	\$48.00	NATURALISTIC	\$100.00
MINERAL GLOW	\$52.00	MODERN FRAME	\$58.00	MORGANS POINT	\$46.00	MURRIETTA	\$35.97	NATURE VALLEY	\$75.97
MINI BEAD FRING	\$62.00	MODERN KEY	\$68.00	MORGANZA WAY	\$66.00	MUSCADINE	\$58.00	NATURES GUESTS	\$61.97
MINI BOXES	\$41.97	MODERN LINEN	\$55.00	MORNING BLISS	\$51.97	MUSIC NOTES	\$20.00	NATURES WEB	\$100.00
MINI CHECK	\$11.97	MODERN LINES	\$22.00	MORNING CIRCLE	\$26.00	MUSICAL CHART	\$62.00	NAUGHTY NET	\$21.00
MINI CORAL	\$80.00	MODERN LINKS	\$48.00	MORNING DAWN	\$77.97	MUTED STRIPES	\$54.97	NAUTICAL MILE	\$56.00
MINI DROPS	\$52.00	MODERN LIVING	\$34.00	MORNING LIGHT	\$53.97	MY BOY	\$62.00	NAVAJO NATION	\$26.00
MINI FLOWERS	\$54.97	MODERN MAGIC	\$56.00	MORNING SKY	\$78.00	MY BUDDY	\$25.97	NAVAJO POINT	\$57.97
MINI HONEYCOMB	\$61.00	MODERN MELTON	\$59.00	MORNING TIDE	\$42.00	MY FLOWERS	\$77.97	NAVIGATE	\$71.97
MINI LEAVES	\$62.00	MODERN MIX	\$65.00	MORNING WISP	\$72.00	MY GIRL	\$66.00	NAVIGATOR	\$87.97
MINI LIP TWIST	\$19.00	MODERN OVALS	\$54.00	MOROCCAN TILE	\$59.00	MY WAY	\$42.00	NAVIS GLIMMER	\$22.00
MINI NETWORK	\$30.00	MODERN PUZZLE	\$48.00	MOROSO	\$88.00	MYAKI	\$32.00	NAZZARO	\$78.97
MINI PEARLS	\$65.00	MODERN SHAPES	\$26.00	MORPHIC	\$65.97	MYAKI TRELLIS	\$38.00	NEEDLE WORK	\$52.00
MINI PETALS	\$61.97	MODERN TIMES	\$57.97	MOSAIC	\$67.97	MYANMAR	\$58.00	NEEDVILLE	\$32.00
MINI PUFFING	\$38.00	MODERN TRACERY	\$44.00	MOSAIC DIAMOND	\$61.97	MYCENAE	\$23.97	NEHRU	\$74.00
MINI TASSELS	\$51.97	MODERN TRELLIS	\$34.00	MOSAIC FIELD	\$82.00	MYERS JOURNEY	\$49.00	NEKO	\$77.97
MINI TOPIARY	\$77.97	MODERN TWEED	\$46.00	MOSAIC FUN	\$50.00	MYRA	\$40.00	NELLIECOYNE	\$59.00
MINI TWINE	\$51.97	MODERN VINE	\$38.00	MOSAIC PLAID	\$26.00	MYRICK	\$42.00	NELSON TEXTURE	\$18.00
MINI TWIST	\$19.97	MODERN WAY	\$77.00	MOSAIC VIEW	\$80.00	MYRNA MYRNA	\$45.00	NEPTUNES NET	\$58.00
MINI VINE	\$45.00	MODEST PLUSH	\$44.97	MOSSY LOG	\$74.00	MYRON STRIPE	\$65.97	NESTING CUBES	\$29.97
MINI ZIGZAG	\$44.00	MOHEGAN GARDEN	\$27.97	MOTIVATION	\$58.97	MYSTERY NET	\$89.00	NESTING ZIGZAG	\$44.00
MINIMALIST	\$44.00	MOJO	\$65.97	MOUNT LAUREL	\$78.00	MYSTIC DAWN	\$48.00	NESTLING	\$67.97
MINNEOLA	\$78.97	MOLALA	\$48.00	MOUNTAIN ASH	\$63.97	MYSTIC FOREST	\$32.00	NETT LAKE	\$75.97
MINNETONKA	\$70.00	MOLIERE	\$69.97	MOUNTAIN CAVE	\$52.00	MYSTIC GLOW	\$52.00	NEVER ENDING	\$77.97
MINNOW BROOK	\$52.00	MOMPOX	\$59.00	MOUNTAIN PATHS	\$40.00	MYSTIC TWILIGHT	\$54.97	NEW ALIGNMENT	\$58.00
MINOTTI	\$66.00	MONET FLORAL	\$28.00	MOVE ALONG	\$48.00	MYSTICAL LINES	\$52.00	NEW CLASSIC	\$26.00
MINYA	\$74.97	MONGOL EMPIRE	\$32.00	MOVE ON	\$55.00	MYTHOS	\$102.00	NEW CONTOURS	\$55.00

WHOLESALE TRADE PRICE LIST
800.333.3777

ROBERT ALLEN accepts MasterCard, Visa® and American Express

ROBERT ALLEN

PATTERN	PRICE	PATTERN	PRICE	PATTERN	PRICE	PATTERN	PRICE	PATTERN	PRICE
NEW DAMASK BK	\$26.95	NOVA WINTER WHT	\$188.00	OLD SILVER WAY	\$45.00	ORCHARD BROOK	\$55.00	PACHINKO	\$38.97
NEW DAWN	\$40.97	NOVASUEDE	\$139.00	OLDENBURG	\$73.97	ORCHARD HILL	\$56.00	PACIOTTI	\$62.00
NEW DIMENSION	\$34.00	NU INNOVATION	\$24.00	OLENSKA	\$45.97	ORDAIN	\$67.97	PACOMIO	\$62.00
NEW DIRECTION	\$78.00	NUBUCKSTON	\$28.00	OLGA	\$23.97	ORFEO	\$75.00	PADDED FLORAL	\$61.97
NEW FRONTIER	\$52.00	NUMBER FRENZY	\$40.00	OLGA-CUSTOM	\$13.97	ORGANIC	\$47.97	PADDINGTON	\$19.95
NEW GARDENS	\$38.00	NUNKI	\$37.97	OLIMPO	\$45.00	ORIENTAL FLUTE	\$73.97	PADEN	\$21.97
NEW GENERATION	\$56.00	NURTURE	\$84.00	OLINCIA	\$63.97	ORIENTAL PARK	\$34.00	PADRA PAISLEY	\$74.00
NEW LOOK	\$24.00	NYALITH	\$32.00	OLIVETO	\$15.97	ORIGAMI	\$54.00	PADULA	\$28.00
NEW MEADOW	\$32.00	NYANKO	\$24.00	OLIVIA STRIE	\$61.97	ORINOQUIA	\$34.00	PAGAN DYNASTY	\$50.00
NEW MOON	\$69.97	NYDIA	\$54.97	OLMSTEAD	\$49.97	ORIZZONTE	\$36.00	PAGODA PASS	\$42.00
NEW RIVIERA	\$66.00	NYOLANI	\$25.00	OMALLEY	\$33.97	ORLOWSKI	\$61.97	PAINT SPRAY	\$48.00
NEW SENSATION	\$39.97	NYORI	\$24.00	OMBRE FLEUR	\$19.95	ORNATE BEAUTY	\$58.97	PAINT STROKES	\$94.00
NEW TEXTURE	\$38.00	NYUMBA	\$55.00	OMBRE FRAME	\$19.95	ORNATE FLORAL	\$72.00	PAINTED DESERT	\$51.97
NEW TICKING	\$22.00	OAHU STRIPE	\$20.00	OMBRE VIEW	\$28.00	ORNATE STRIPE	\$72.00	PAINTED FLOWER	\$40.00
NEWMARKET	\$35.97	OAKFIELD	\$72.00	OMHEINING	\$60.00	OROSCO	\$62.00	PAINTED GARDEN	\$25.00
NEWPERRAN	\$55.00	OAKTREE TRAIL	\$80.00	ON A WHIM	\$75.97	OROVADA	\$58.97	PAINTED IKAT	\$66.00
NEWTON CORNER	\$38.00	OAKVILLE QUILT	\$44.97	ON DECK	\$55.97	ORTANIQUE	\$54.97	PAINTED LINES	\$69.00
NIAMH	\$20.00	OASIS PATCH	\$38.00	ON THE COMMON	\$59.00	ORURO	\$58.00	PAISLEY BAY	\$26.00
NICE N NEAT	\$34.00	OATES	\$46.00	ON THE EDGE	\$25.97	ORVIETO	\$92.00	PAISLEY BEAUTY	\$79.00
NICHOLAS	\$30.00	OBAMA	\$62.00	ON THE LAKE	\$53.97	ORVIS	\$42.00	PAISLEY CAMEO	\$70.00
NICK NACK	\$32.00	OBAX	\$71.97	ON THE ROCKS	\$78.00	OSCAR CHECK	\$25.00	PAISLEY COVE	\$32.00
NICKS NOTES	\$59.00	OBDULIO	\$56.00	ON THE RUN	\$52.00	OSCEOLA	\$57.97	PAISLEY GRACE	\$26.00
NICOLETTE	\$36.00	OBERNAI	\$45.97	ON THE SPOT	\$36.97	OSGOOD MANOR	\$58.00	PAISLEY LAGOON	\$49.00
NIGHT AND DAY	\$9.00	OBERON	\$14.00	ONESIMO	\$61.97	OSTENTATIOUS	\$73.97	PAISLEY PARK	\$54.00
NIGHT LIFE	\$62.00	OBLIGE	\$51.97	ONLINE	\$57.97	OTAVALO	\$32.00	PAISLEY PATCH	\$24.00
NIGHT MAGIC	\$70.00	OCALE	\$38.97	ONONDAGA	\$61.97	OTIS	\$59.00	PAISLEY PRINT	\$36.00
NIGHT STALKER	\$125.00	OCEAN BEAUTY	\$58.00	OPAL CREEK	\$48.00	OUR GENERATION	\$40.97	PAISLEY PUFF	\$66.00
NIGHT STAR	\$50.00	OCEAN CITY	\$64.00	OPAL LINE	\$78.00	OURAY	\$99.00	PAISLEY SUEDE	\$97.97
NIGHT WALK	\$16.00	OCEAN DRIVE	\$42.97	OPEN AND SHUT	\$67.97	OUSTER	\$67.97	PAISLEY TAPE	\$19.00
NIM	\$24.97	OCEAN LINER	\$60.97	OPEN BLOCKS	\$45.00	OUT AND ABOUT	\$42.00	PAISLEY TOSS	\$48.00
NITTLES	\$62.00	OCEAN PLAID	\$43.97	OPEN FIELD	\$26.00	OUT OF BOUNDS	\$55.00	PAISLEY VELVET	\$48.00
NO PHOTOS PLS	\$39.00	OCEAN ROPE	\$59.00	OPEN LINES	\$24.00	OUT OF ORBIT	\$34.00	PAISLEY WAY	\$44.00
NOBLEWOOD	\$20.00	OCEAN SCROLLS	\$28.00	OPEN MEADOW	\$36.00	OUT OF THE BOX	\$38.00	PAISLEY WITHIN	\$65.97
NOD	\$67.97	OCEAN SHELLS	\$78.00	OPEN MIND	\$49.00	OUT OF TIME	\$52.00	PAJERO	\$66.00
NONCHALANT	\$72.00	OCEAN STRIPE	\$48.97	OPEN PLAIN	\$48.00	OUTBLOOM	\$80.00	PALACE STRIPE	\$42.00
NONSTOP	\$19.95	OCEAN WAVES	\$68.00	OPEN PRAIRIE	\$32.00	OUTDOOR BOUCLE	\$69.00	PALECEK	\$88.00
NORBERT	\$51.97	OCOSINGO	\$54.00	OPEN SEA	\$35.97	OUTER BANKS	\$62.00	PALILA	\$67.97
NORDIC STRIPE	\$70.00	OCRACOCKE	\$62.00	OPEN SPACES	\$38.00	OUTER LIMITS	\$66.00	PALISADAS	\$84.00
NOREEN	\$44.97	OCTAVE	\$39.00	OPEN SQUARES	\$80.00	OUTLANDISH	\$36.00	PALM BAY	\$41.97
NORTH CLIMB	\$71.97	OCTAVIANO	\$66.00	OPEN TERRITORY	\$50.00	OUTLOOK	\$20.95	PALM CANYON	\$58.00
NORTH COMFORT	\$34.00	OCTOSHAP	\$27.97	OPEN VIEW	\$30.00	OUTSHINES	\$40.00	PALM COAST	\$73.97
NORTH LANDING	\$78.00	ODIE OH	\$56.00	OPEN WEAVE	\$44.00	OUTSIDE VIEW	\$32.00	PALM DASH	\$67.97
NORTH SIDE	\$42.00	OFF AND ON	\$28.00	OPENING DAY	\$39.00	OUTSKIRTS	\$51.97	PALM RESORT	\$99.00
NORTH STREET	\$45.00	OFF THE HOOK	\$64.00	OPERA NOTES	\$84.00	OVAL CIRCLE	\$48.00	PALM VALLEY	\$34.00
NORTHCOURT	\$54.97	OFFBEAT	\$40.00	OPTIC ILLUSION	\$27.97	OVAL CONNECT	\$26.00	PALMEIRO	\$51.97
NORTHVIEW	\$55.00	OFFICE SPACE	\$70.00	OPTIC MOVES	\$35.00	OVAL FLOWER	\$45.00	PALMER PLAIN	\$58.00
NORWEGIAN WOOD	\$65.97	OFFSET STRIPE	\$25.00	OPTIC ROWS	\$52.00	OVAL MOTIF	\$36.00	PALMER STRIPE	\$82.00
NOTTINGHAM WAY	\$51.97	OGALALLA	\$34.00	OPTIC WAVE	\$48.97	OVER AND OVER	\$46.00	PALMESE	\$52.00
NOVA	\$20.00	OGEE MAZE	\$66.00	OPTICAL ART	\$60.00	OVER STITCH	\$30.00	PALMILLON	\$70.00
NOVA BARK	\$199.00	OGEE RIBBON	\$63.97	OPTICAL DOTS	\$68.00	OVERSIZE STRIPE	\$34.00	PALMWOOD	\$74.00
NOVA BUTTERCRM	\$188.00	OGEE SWIRLS	\$42.00	OPTICAL FACET	\$19.95	OWEN	\$14.00	PANCOAST	\$64.00
NOVA CHAMOIS	\$188.00	OH DEAR	\$45.00	OPTICAL NET	\$34.00	OXFORD CIRCUS	\$32.00	PANDORA	\$37.97
NOVA JADE	\$188.00	OH MY WOVEN	\$36.00	OPTICAL WAVE	\$70.00	OXFORD STREET	\$30.00	PANEL WEAVE	\$32.00
NOVA MUSHROOM	\$188.00	OHIO FR	\$6.00	OPTIMA	\$32.00	OXFORD UNQUILT	\$24.00	PANERA	\$77.97
NOVA NOIR	\$188.00	OKAPI	\$26.97	ORATOR	\$54.97	OXMORE	\$67.97	PANSY PARK	\$52.00
NOVA OATMEAL	\$188.00	OKEMO	\$45.00	ORBITAL	\$32.00	OXWICH	\$71.97	PANTEGO	\$19.95
NOVA SABLE	\$188.00	OKETA	\$28.00	ORBITZ	\$56.00	OZIAN	\$59.00	PANYA	\$87.97
NOVA W WHITE	\$188.00	OLANDER	\$28.00	ORCHARD BAY	\$34.00	PABLOS PASSION	\$82.00	PANZANO	\$8.97

WHOLESALE TRADE PRICE LIST
800.333.3777

ROBERT ALLEN accepts MasterCard, Visa® and American Express

ROBERT ALLEN

PATTERN	PRICE	PATTERN	PRICE	PATTERN	PRICE	PATTERN	PRICE	PATTERN	PRICE
PAOLO	\$50.00	PAULA JEAN	\$69.97	PERIANDER	\$65.97	PINCEAUX	\$49.00	PLUSH LANAI	\$79.00
PAPARAZZI	\$67.97	PAUSE	\$39.00	PERION	\$22.00	PINCKNEY	\$43.97	PLUSH ROYAL	\$54.97
PAQUETTE	\$57.97	PAVATI	\$29.97	PERISCOPE	\$55.97	PINDOT	\$67.97	PLUSH SOFTY	\$28.00
PARADE PARK	\$67.97	PAVED PATH	\$52.00	PERKINS COVE	\$47.97	PINEAPPLE BOX	\$75.00	PLUSH STAR	\$62.00
PARADIGM	\$57.97	PAYDAY	\$38.00	PERPLEX	\$87.97	PINEAPPLE GROVE	\$79.00	PLUSH STRIE	\$35.00
PARAGON STRIPE	\$62.00	PEACEFUL	\$62.00	PERRANPORTH	\$52.00	PINEVIEW	\$58.00	PLUSH TROPICS	\$93.97
PARAMETER	\$60.97	PEACEFUL DREAM	\$32.00	PERRYHILL	\$64.00	PINJARA	\$67.97	PLYMOUTH TWIST	\$25.97
PARANA	\$36.00	PEACEFUL POND	\$77.97	PERSUASION	\$52.00	PINK FLAMINGO	\$57.97	POBLADO	\$59.00
PARFAY	\$27.97	PEACOCK OCELLI	\$24.00	PERSUIT II	\$62.00	PINWHEEL	\$28.00	POHLMAN	\$37.97
PARISIAN BD RST	\$10.00	PEACOCK TAILS	\$67.97	PETAL ARRAY	\$78.00	PIONELLA	\$70.00	POINT AHEAD	\$30.00
PARISIAN CHAIR	\$16.00	PEACOCK TRAIN	\$66.00	PETAL BUNCH	\$25.00	PIPE DREAMS	\$66.00	POINT BLANK	\$48.00
PARISIAN KEY	\$30.00	PEAKING OUT	\$64.00	PETAL PARTY	\$62.00	PIPER PLAID	\$22.00	POINT OF VIEW	\$42.00
PARISIAN TBCK	\$78.00	PEARL DROP	\$42.00	PETAL POWER	\$30.00	PIPING STRIPE	\$30.00	POINT WIGWAM	\$40.00
PARISIENNE	\$40.97	PEAT BOG	\$79.00	PETAL SPLASH	\$74.00	PIQUE	\$172.00	POINTED PEAKS	\$48.00
PARK DIAMOND	\$59.00	PEBBLE SHEEN	\$94.00	PETIT CERISE	\$58.97	PIVOT DIAMOND	\$52.00	POINTED TOPS	\$52.00
PARK DRIVE	\$34.97	PEBBLE STITCH	\$25.00	PETIT CHECK	\$29.00	PIXEL	\$46.00	POINTS NORTH	\$52.00
PARK SQUARE	\$50.00	PEBBLE WALK	\$74.00	PETITE CHARM	\$59.00	PIXIE DUST	\$78.00	POLANER	\$73.97
PARK STREET	\$48.00	PEBBLED PATH	\$48.00	PETITE CORD	\$10.00	PIZAZZ	\$70.00	POLO BEACH	\$39.00
PARK VIEW	\$68.97	PEBBLESHIRE	\$62.00	PETITE FLOWER	\$51.97	PLACERVILLE	\$83.97	POMERANCE	\$43.97
PARKY	\$47.97	PECORE PLAID	\$52.00	PETITE JARDIN	\$77.97	PLAID IKAT	\$42.00	POMPTON	\$38.00
PARKER HOUSE	\$66.00	PEDANTIC	\$54.97	PETITE LINES	\$61.97	PLAID MANIA	\$32.97	PONDEROSA PINE	\$35.00
PARKING LOT	\$48.00	PEEK	\$75.00	PETITE ROPE CRD	\$16.00	PLAID MAT	\$80.00	POP PAISLEY	\$37.97
PARMINDER LANE	\$78.00	PEGGYS COVE	\$30.00	PETITE ROSES	\$61.97	PLAID PALMS	\$44.00	POPEIL	\$31.97
PARSBURG	\$38.00	PELAYO	\$62.00	PETROVA	\$66.00	PLAID PIZAZZ	\$28.00	POPS ON STICKS	\$56.00
PARSI	\$58.00	PELHAM HOUSE	\$55.00	PETRUS	\$48.00	PLAID TOUCH	\$20.00	PORRIMA	\$61.97
PARSONS WOODS	\$58.00	PELHAM RANGE	\$44.00	PEYTON	\$26.00	PLAID WOOL	\$89.00	PORT DOVER	\$39.00
PARTED WAYS	\$28.00	PELL CITY	\$28.00	PHANTOM MANOR	\$34.00	PLAIDITA	\$54.97	PORT OF CALL	\$47.97
PARTRIDGE	\$73.97	PEMBRIDGE	\$54.00	PHEASANT TAILS	\$62.00	PLAIN COUNTRY	\$32.00	PORT RICHEY	\$24.00
PARTY CENTER	\$49.00	PENAOTTO	\$33.97	PHILBRICK	\$70.00	PLAIN ELEGANCE	\$11.00	PORTER SQUARE	\$24.00
PARTY PLAID	\$26.00	PENARTH	\$33.97	PHILENA STRIPE	\$53.97	PLAIN FIELD	\$40.00	PORTOFINO	\$28.00
PARTY STRIPE	\$70.00	PENCE II	\$20.97	PHYLLO	\$88.97	PLAIN N SIMPLE	\$34.00	POSEY FIELD	\$57.97
PARTY TIME	\$26.00	PENCHANT	\$72.00	PHYREN	\$32.00	PLAIN STRIPE	\$40.00	POSH PLEAT	\$44.00
PASCOAG	\$73.97	PENCIL STRIPE	\$54.97	PICK A DIAMOND	\$40.00	PLAINVIEW	\$34.97	POSH SHEEN	\$56.00
PASILLO	\$54.97	PENDARVIS	\$48.97	PICKARD	\$25.00	PLANT LIFE	\$70.00	POT HOLDER	\$38.97
PASSING LANE	\$58.00	PENDULOUS	\$54.97	PICKETT FENCE	\$65.97	PLANTERSVILLE	\$58.00	POTENTIAL	\$91.97
PASSION LEAVES	\$61.97	PENNACOOK	\$47.97	PICKLED PLAID	\$38.00	PLATFORM	\$75.97	POTOSI	\$65.97
PASSPORT	\$53.97	PENNYMORE	\$34.00	PICNIC BASKET	\$53.97	PLAY BACK	\$44.00	POTTED CACTI	\$61.97
PASTEL CHECK	\$59.00	PENNYWHISTLE	\$43.97	PICNIC BLANKET	\$26.00	PLAY BILL	\$68.97	POWDER BLUE	\$38.00
PASTENE	\$75.00	PENSKE	\$75.97	PICNIC CLOTH	\$62.00	PLAY IT COOL	\$56.00	POWER GRID	\$22.00
PASTICHE	\$39.00	PENSTEMON	\$31.97	PICNIC FUN	\$24.00	PLAY IT UP	\$44.00	POWER LINES	\$28.00
PATADAY	\$42.00	PENTA	\$19.95	PICNIC LUNCH	\$55.00	PLAYA CARMEN	\$25.00	POWERPOINT	\$88.97
PATCH	\$32.00	PENTUCKET	\$19.95	PICNIC PATCHES	\$65.00	PLAYBOX	\$62.00	PRAIRIE DUNE	\$19.00
PATCHED CIRCLE	\$70.00	PENZANCE	\$65.97	PICNIC PLAID	\$38.00	PLAYFUL STRIPE	\$58.00	PRAIRIE WINDS	\$67.97
PATCHING	\$30.00	PEREGRINE	\$66.00	PICNIC SPREAD	\$40.00	PLAZA DAMASK	\$40.97	PRAVIA	\$52.00
PATCHWORK	\$77.97	PERFECT BEAUTY	\$36.00	PICNIC TIME	\$57.97	PLAZA PAISLEY	\$59.00	PRAWLE POINT	\$20.00
PATCHWORK LINE	\$64.00	PERFECT CHOICE	\$52.00	PICOT GIMP	\$10.00	PLEASANT ROAD	\$24.00	PRAZZO	\$54.97
PATEL	\$57.97	PERFECT FLOWER	\$72.00	PICTURE PATH	\$56.00	PLEASANT VIEW	\$50.00	PRECIOUS METAL	\$82.00
PATENT CORD	\$14.00	PERFECT IKAT	\$43.97	PIECE TOGETHER	\$42.00	PLEAT SOUND	\$48.00	PRECISE STITCH	\$52.00
PATENTED	\$40.00	PERFECT MATCH	\$55.00	PIEDRAS	\$99.00	PLEATED BAND	\$30.00	PRECOCIOUS	\$66.00
PATHWAYS	\$80.00	PERFECT MIX	\$68.00	PIERMONT	\$66.00	PLEATED CHIC	\$69.97	PREFERENTIAL	\$44.00
PATIO BLANKET	\$66.00	PERFECT SPRING	\$34.00	PIERON	\$58.00	PLEATED STRIPE	\$45.00	PREMIERE	\$61.97
PATIO CANOPY	\$55.00	PERFECT TOUCH	\$134.00	PIGEON FORGE	\$67.97	PLEATING HEART	\$73.97	PREMIUM LUSH	\$38.00
PATIO GARDEN	\$65.00	PERFECT TWEED	\$32.00	PIKAKE	\$32.00	PLENTY PLAID	\$40.00	PRENTISS	\$52.00
PATIO PLANTS	\$73.97	PERFECT VIEW	\$22.00	PILLOW TALK	\$55.00	PLEXITY	\$81.97	PRESENTABLE	\$56.00
PATIOLOUNGE	\$61.97	PERFECT WAVE	\$45.00	PILLOWTALK	\$47.97	PLINKO	\$42.00	PRESERVE	\$83.97
PATRICE	\$24.00	PERFECTA	\$56.00	PIMA POINT	\$48.00	PLUSH CHECKERS	\$44.97	PRESIDIO	\$77.97
PATSY LANE	\$61.97	PERFECTO	\$66.00	PIN WHEEL	\$45.00	PLUSH DOTSCAPE	\$78.00	PRESTIGIOUS	\$24.97
PATZER	\$57.97	PERFORATED NOVA	\$172.00	PINAFORE	\$67.97	PLUSH GROUNDS	\$65.97	PRESTO DOT	\$54.97

WHOLESALE TRADE PRICE LIST
800.333.3777

ROBERT ALLEN accepts MasterCard, Visa® and American Express

ROBERT ALLEN

PATTERN	PRICE	PATTERN	PRICE	PATTERN	PRICE	PATTERN	PRICE	PATTERN	PRICE
PRESTWICK	\$48.00	QUALITY TIME	\$66.00	RADIANT GARDEN	\$32.00	RAY RAY	\$34.00	RETRO FLOWER	\$42.00
PRETTY BASKET	\$38.00	QUANNAPOWITT	\$62.00	RADIANT HEART	\$74.00	RAYMOUR	\$30.00	RETRO GEO	\$57.97
PRETTY LOOKING	\$65.00	QUARTER TIME	\$77.97	RADIANT STRIPE	\$26.00	RAZIEL	\$36.00	RETRO MOVE	\$30.00
PRETTY PLEASE	\$25.00	QUARTERPATH	\$42.00	RADIANT VELVET	\$101.97	RAZZAMATAZ	\$84.00	RETRO STRIPE	\$40.00
PRETTY POSY	\$36.00	QUATREFOIL	\$61.97	RADICAL ROAD	\$52.00	RAZZLE DAZZLE	\$58.00	REVAMP	\$38.97
PRETTY STRIPE	\$52.00	QUAYLE	\$52.00	RADIO STATIC	\$32.00	READY SET GO	\$58.00	REVERB	\$77.97
PRETTY SWIRLS	\$56.00	QUEBEC	\$36.00	RADIO WAVE	\$74.00	REAL TIME	\$57.97	REVERBERANT	\$38.00
PRETTY VIEW	\$45.00	QUEEN CHEETAH	\$74.00	RADIUM SPRINGS	\$51.97	REALISTIC	\$30.00	REVERENCE	\$51.97
PRETTY WEAVE	\$52.00	QUEEN LIZ	\$67.97	RAE	\$55.00	REALITY LINE	\$30.00	REVIVAL	\$62.00
PRICIPLE LINES	\$75.00	QUEENS COURT	\$88.00	RAFAEL UPTOWN	\$52.00	RECLINER	\$52.00	REVIVE	\$76.00
PRIDILIANO	\$66.00	QUEENS CREEK	\$40.00	RAFFIA BRAID	\$26.00	RECONSIDER	\$44.97	REVOLVE	\$19.95
PRIMERA	\$19.95	QUEENS PARK	\$40.00	RAFFIA PATH	\$64.97	RECTANGULOS	\$66.00	REXINE	\$20.00
PRIMPING	\$28.00	QUEENSLEY	\$70.00	RAGIN CAJUN	\$42.00	RED CLOUD	\$54.97	REYES	\$28.00
PRINCE EDWARD	\$24.00	QUERIDA	\$71.97	RAGINI	\$49.97	RED ROCKS	\$112.00	RHODOPHYTA	\$75.00
PRISM	\$56.00	QUERUBIN	\$52.00	RAGLAN STITCH	\$40.00	REDREAMS	\$44.00	RHYTHM WAVES	\$59.00
PRISMATIC	\$56.00	QUESTION	\$54.97	RAIBEL	\$59.00	REDSTONES	\$25.00	RHYTHM WAVES BK	\$62.00
PRIVATE LINES	\$75.97	QUICK FLASH	\$45.00	RAIL TIES	\$53.97	REFERENCE	\$40.97	RIB WAVE	\$19.95
PROCOPIO	\$67.97	QUICKENING	\$40.00	RAIL TRAIL	\$36.00	REFINED	\$94.00	RIBBED BAND	\$38.00
PROENZA	\$64.00	QUIET SPLENDOR	\$40.00	RAILROAD TRACK	\$45.00	REFINED DESIGN	\$20.00	RIBBED BOUCLE	\$59.97
PROFILE	\$57.97	QUIET SQUARES	\$55.00	RAIN DROPS	\$88.00	REFINED GRID	\$25.00	RIBBED BUTTON	\$16.00
PROFLEX	\$67.97	QUILBY	\$48.00	RAIN SHOWER	\$20.00	REFINED LINES	\$134.00	RIBBED LINES	\$77.97
PROFUSION	\$42.00	QUILL FANCY	\$30.00	RAIN STORM	\$48.00	REFINED STRIPE	\$24.97	RIBBED SOLID	\$29.00
PROMENADE	\$27.97	QUILL TIPS	\$52.00	RAINBOW BRIGHT	\$25.00	REFINEMENT	\$55.00	RIBBET	\$31.97
PROMETHEUS	\$65.97	QUILMES	\$56.00	RAINBOW STRIPE	\$39.00	REFLECTIVITY	\$148.00	RIBBING	\$44.00
PROMISE LAND	\$30.00	QUILT HAMPTON	\$44.97	RAINDROP	\$118.00	REFRACTION	\$148.00	RIBBON BOXES	\$31.97
PROPORTION	\$30.97	QUILTED APTOBE	\$51.97	RAINIER PLAID	\$83.97	REGAL BLOOM	\$94.97	RIBBON DANCE	\$68.00
PROSPEROUS	\$56.00	QUILTED BLOCKS	\$55.00	RAISED BAR	\$58.00	REGAL JEWEL	\$63.97	RIBBON DIAMOND	\$56.00
PROVENCE	\$30.00	QUILTED DIAMOND	\$54.97	RAISED CIRCLE	\$28.00	REGAL LOOPS	\$22.00	RIBBON EFFECT	\$68.00
PROVIDENCE	\$70.00	QUILTED DOTS	\$42.00	RAISED DIAMOND	\$78.00	REGAL MOTIF	\$40.00	RIBBON FENCE	\$24.00
PUCCIO CHECK	\$55.00	QUILTED FLOWER	\$77.97	RAISED GEO	\$38.00	REGENCY BOARD	\$88.00	RIBBON LOOP	\$25.00
PUCKER DOT	\$47.00	QUILTED LEAVES	\$48.00	RAISED LINES	\$40.00	REGENCY CHINTZ	\$36.00	RIBBON SHIMMER	\$24.00
PUCKER PLAID	\$32.00	QUILTED OXFORD	\$41.97	RAISED ROWS	\$52.00	REGENCY LINEN	\$26.00	RIBBON TWIST	\$47.00
PUCKER STRIPE	\$25.00	QUILTED PAOLO	\$53.97	RAISED UP	\$28.00	REGENCY SHEERS	\$119.00	RIBBONTROP	\$30.00
PUCKERED LINES	\$66.00	QUILTED PLAID	\$54.97	RAISING GRACE	\$22.00	REGENCY STRIPE	\$58.00	RICEGRASS	\$65.00
PUCKERED MESH	\$65.00	QUILTED SCROLL	\$72.00	RAJASTHAN	\$58.00	REGIMENT	\$18.95	RICH LINES	\$24.97
PUFFY PATH	\$50.00	QUILTED SHAPES	\$26.00	RAJETA	\$61.97	REIMAN GARDEN	\$58.00	RICO	\$25.00
PUFFY STRIPE	\$34.00	QUILTED SILK	\$77.97	RALEIGH TAVERN	\$42.00	REIMS	\$44.97	RICRAC PLEAT	\$26.00
PULCERA	\$58.00	QUILTED STAR	\$78.00	RALLY ROAD	\$42.00	REINALDO	\$52.00	RIDGE PEAK	\$28.00
PULQUI	\$62.00	QUILTED TIME	\$59.00	RAMBLING UP	\$56.00	REJUVENATE	\$72.00	RIDGE ROAD	\$28.00
PUNDANT	\$50.97	QUILTING	\$80.00	RAMBLING VINES	\$30.00	RELAXED HUES	\$24.00	RIDGE RUNNER	\$35.97
PURDY	\$56.00	QUILTWORK	\$91.97	RANA	\$38.00	RELAXING LINE	\$32.00	RIDGEBACK	\$88.97
PURE BLISS	\$40.00	QUIMP	\$58.00	RANCHERO	\$38.97	REMARKABLE	\$67.97	RIGGS	\$38.97
PURE DECOR	\$39.00	QUINN	\$25.00	RANDALL STRIPE	\$56.00	REMBOLD	\$74.00	RIGHT COMBO	\$22.00
PURE ELEMENT	\$84.00	QUINTESSENCE	\$88.00	RANGELLA	\$57.97	REMIK	\$71.97	RILEY BLOCKS	\$25.00
PURE ULTRASUED	\$115.97	QUIRINO	\$52.00	RAPUNZEL	\$133.97	REMOTE CONTROL	\$52.00	RIMOUSKI	\$68.00
PURITANICAL	\$74.00	QUITE SPLENDID	\$84.00	RARE BEAUTY	\$100.00	REMY PLAID	\$34.00	RING IN	\$55.00
PURTON PIKE	\$46.00	QUIZ	\$55.97	RARE ELEGANCE	\$57.97	RENDA	\$69.97	RING STITCH	\$79.00
PUZZLE	\$50.97	QUOETTE	\$77.97	RATANA SWIRL	\$62.00	RENFREWSHIRE	\$30.00	RING THROUGH	\$19.95
PUZZLE PIECES	\$75.97	QUOTATIONS	\$62.00	RATH YATRA	\$62.00	RENVYLE	\$82.00	RINGLEADER	\$64.00
PUZZLE PLAY	\$49.00	RABBIT RUN	\$42.00	RATHCOOLE	\$56.00	REP ESPRESSO	\$166.00	RINGO	\$42.97
PUZZLE RIDGE	\$58.00	RACE STRIPE	\$75.00	RATHCORMAC	\$62.00	REP WINTER WHT	\$184.00	RINNA STRIPE	\$58.00
PUZZLE SHAPES	\$59.00	RACE TRACK	\$62.00	RATHDRUM	\$51.97	REPRESENTATIVE	\$116.00	RINOMATO	\$64.00
PUZZLED PATH	\$62.00	RACEWAY	\$36.00	RATHFARNHAM	\$29.97	REPRISE	\$87.97	RIO SWIRL	\$84.00
PYRAMID	\$62.00	RACHELLE	\$37.97	RATTAN	\$42.00	REPTILE LUSTER	\$94.00	RIPPLE SOLID	\$22.00
PYRAMID CLUB	\$64.97	RACING STRIPE	\$42.00	RATTAN LINES	\$58.00	RESOURCEFUL	\$69.00	RIPPLEHILL	\$82.00
PYTHON CORD	\$14.00	RADAMES	\$75.00	RAVISHING	\$40.00	RETRO BUBBLE	\$41.97	RIPPLING LEAF	\$79.00
QUAD	\$48.00	RADIANT CHINTZ	\$36.00	RAY JASPEN	\$70.00	RETRO DOTS	\$61.97	RIPPLING RIVER	\$42.00
QUAINT SCROLL	\$32.00	RADIANT FLORAL	\$82.00	RAY OF LIGHT	\$36.00	RETRO FASHION	\$35.00	RISARALDA	\$44.00

WHOLESALE TRADE PRICE LIST
800.333.3777

ROBERT ALLEN accepts MasterCard, Visa® and American Express

ROBERT ALLEN

PATTERN	PRICE	PATTERN	PRICE	PATTERN	PRICE	PATTERN	PRICE	PATTERN	PRICE
RISING SUN	\$88.00	ROMILDO	\$60.00	RUMER GLENN	\$26.00	SALICARIA	\$41.97	SAVING GRACE	\$48.00
RISING UP	\$66.00	RONA	\$39.00	RUMSFELD	\$73.97	SALLY GARDENS	\$34.00	SAVOY	\$49.00
RISK	\$48.00	RONA STRIPE	\$69.97	RUN TOGETHER	\$26.00	SALLYS SHELLS	\$55.00	SCAFELL	\$75.00
RITZ CREEK	\$61.97	RONDO	\$28.00	RUNAWAY ROAD	\$30.00	SALTARELLO	\$34.00	SCALABRINE	\$34.00
RITZY	\$56.00	ROOFTOP REVERY	\$59.00	RUNIC	\$51.97	SALVAY	\$32.00	SCALED NET	\$32.00
RIVER GEORGE	\$68.00	ROONEY	\$30.00	RUNNING DECOR	\$26.00	SALVE REGINA	\$54.97	SCALLOP SHELL	\$73.97
RIVER PARK	\$46.97	ROOSTER HOLLOW	\$73.97	RUNNING LINES	\$46.00	SAMEER	\$54.97	SCALLOP STRIPE	\$38.00
RIVER ROAD	\$62.00	ROPE JEWELRY	\$51.97	RUNNING PATH	\$35.97	SAMMI ROSE	\$64.00	SCALLOP TRIM	\$58.00
RIVER VALLEY	\$44.00	ROPE STRIPE	\$30.00	RUNNING REEF	\$65.00	SAMUI	\$65.97	SCALLOPED SILK	\$61.97
RIVERDANCE	\$67.97	ROPE TRAIL	\$22.00	RUNNING SQUARE	\$38.00	SAN BENITO	\$42.00	SCAMP	\$39.00
RIVERS BEND	\$35.00	ROSANGELA	\$88.00	RUNNING TRAIL	\$42.00	SAN CRISTOBAL	\$42.00	SCANDO VINE	\$37.00
RIVERST MINI KY	\$16.00	ROSCOMMON	\$79.00	RURAL LIVING	\$28.00	SAN JACINTO	\$59.00	SCAPEGOAT	\$39.00
RIVERSTN BEADS	\$40.00	ROSE MARIE	\$28.00	RUSH HOUR	\$44.00	SAN JAVIER	\$59.00	SCATTERED	\$81.97
RIVERSTN CHRTIE	\$48.00	ROSEBURY	\$30.00	RUSH POND	\$65.97	SAN REMO	\$56.00	SCATTERY ISLE	\$47.97
RIVERSTN KEY TS	\$28.00	ROSEGLN	\$56.00	RUSSELL	\$88.97	SANCHI	\$19.00	SCENTED GARDEN	\$28.00
RIVERTRAIL	\$19.95	ROSELYN	\$24.00	RUSTIC CABIN	\$38.97	SAND CORAL	\$84.00	SCHAEFFER	\$48.00
RIVIERA	\$52.00	ROSENBURG	\$78.00	RUSTIC CHARM	\$73.97	SAND HILL COVE	\$62.00	SHELL CREEK	\$49.00
RIVINGTON	\$39.97	ROSEWORTH	\$73.97	RUSTIC RIB	\$42.00	SAND PEBBLE	\$52.00	SCHENECTADY	\$56.00
RIZER	\$22.00	ROSEY MEADOW	\$52.00	RUSTIC ROAD	\$38.00	SAND STORM	\$55.00	SCOTTIA	\$44.00
ROAD BUMP	\$56.00	ROSHEEN	\$44.00	RUSTIC ROOSTER	\$69.97	SAND TRAILS	\$40.00	SCOTTISH TWILL	\$87.97
ROAD MAZE	\$25.00	ROSS MANOR	\$57.97	RUSTIC SCENE	\$24.00	SANDERS	\$47.97	SCRATCH BOARD	\$25.00
ROADWAY	\$73.97	ROSSCARBERY	\$84.00	RUSTIC TWEED	\$34.00	SANDIWAY	\$42.00	SCREEN SCENE	\$69.97
ROBERTSDALE	\$28.00	ROSSES POINT	\$36.00	RUSTICA BALL	\$55.00	SANDS POINT	\$38.97	SCREENPLAY	\$29.97
ROBILLARD	\$73.97	ROSWITHA	\$52.00	RUSTICA BRUSH	\$42.00	SANDY LANE	\$39.00	SCRIBBLE PAD	\$45.97
ROBINETTE	\$39.00	ROTARY WAY	\$35.00	RUSTICA BULLION	\$40.00	SANDY STRIPE	\$38.00	SCRIBBLES	\$57.97
ROBLED0	\$46.00	ROUGH CROSSING	\$54.97	RUSTICA CHAIR	\$55.00	SANDY WEAVE	\$34.00	SCRIBE	\$70.00
ROC LON 54	\$5.00	ROUGH ROAD	\$32.00	RUSTICA CORD	\$15.00	SANGAMON	\$54.97	SCRIBED ART	\$48.00
ROC LON B/O 54	\$9.00	ROUGH SPOT	\$32.00	RUSTICA FLMSTCH	\$32.00	SANKATY	\$73.97	SCROLL BRAID	\$52.00
ROC LON B/OFR	\$10.00	ROUGH TIME	\$76.00	RUSTICA GIMP	\$15.00	SANTA CRUZ	\$49.00	SCROLL LINES	\$58.00
ROCK CREEK	\$58.00	ROUGH WEAVE	\$42.00	RUSTICA GRILLE	\$26.00	SANTA FE	\$38.00	SCROLL MAZE	\$19.00
ROCK CRYSTAL	\$88.00	ROUND RIDGE	\$28.00	RUSTICA KEY	\$30.00	SANTERNO	\$22.00	SCROLL TEXTURE	\$67.97
ROCK FALLS	\$40.00	ROUNDAABOUT	\$19.95	RUSTICA LATTICE	\$26.00	SAQUISILI	\$75.00	SCROLLED LINKS	\$39.00
ROCK RESORT	\$73.97	ROW BY ROW	\$38.00	RUSTICA PLEAT	\$36.00	SARABETH	\$61.97	SCROLLING ART	\$89.00
ROCK RIVER	\$52.00	ROWEL	\$58.00	RUSTICA ROPE	\$20.00	SARANDON	\$23.97	SCROLLING LEAF	\$50.00
ROCK WALL	\$52.00	ROWENA DOT	\$19.95	RUSTICA ROUCHE	\$30.00	SARRATT	\$54.97	SCROLLING OMBRE	\$67.97
ROCKERY	\$82.00	ROYAL BEAUTY	\$69.00	RUSTICA SASH	\$94.00	SARFIELD	\$30.00	SCRUMPTIOUS	\$41.97
ROCKPORT	\$49.00	ROYAL CHENILLE	\$38.00	RUSTICA TASSEL	\$72.00	SASHA VELVET	\$38.00	SCRUNCH	\$18.97
ROCKSTAR	\$65.00	ROYAL CITY	\$44.00	RUSTICA TIEBACK	\$66.00	SASHIELL	\$171.97	SEA ANEMONE	\$25.00
ROCKY CREST	\$42.00	ROYAL COMFORT	\$38.00	RUTTMAN	\$45.97	SASSY CURVE	\$42.00	SEA CHANGE	\$51.97
ROCKY KNOLL	\$38.97	ROYAL CROWNS	\$56.00	RWANDA	\$34.00	SATCHEL	\$116.00	SEA CORAL	\$71.97
ROCKY PLAIN	\$45.00	ROYAL CURVES	\$28.00	RYECROFT	\$34.00	SATEEN	\$10.00	SEA DREAM	\$57.97
ROCKY SHORE	\$78.00	ROYAL FLOWER	\$66.00	RYEFIELD	\$73.97	SATEEN STRIPE	\$62.00	SEA FIX	\$23.97
ROCKY TOP	\$71.97	ROYAL JESTER	\$65.97	RYKIEL	\$74.00	SATIN BASKET	\$20.00	SEA LACE	\$40.00
ROCKY WAY	\$78.00	ROYAL MIX	\$48.00	SABADILLA	\$74.97	SATIN LUSTRE	\$18.00	SEA RIDGE	\$37.97
RODENSO	\$59.00	ROYAL PECTENS	\$62.00	SABATIER	\$26.00	SATIN PAISLEY	\$42.00	SEA URCHINS	\$62.00
RODRIGUEZ	\$57.97	ROYAL PRINT	\$32.00	SABRECIA	\$37.97	SATIN PLAIN	\$26.00	SEACREST SHORE	\$39.00
ROGELIO	\$56.00	ROYAL REWARD	\$24.00	SACRED	\$36.00	SATIN SCROLL	\$45.00	SEACREST WAY	\$25.00
ROIATTI	\$40.00	ROYALTY LACE	\$59.00	SADDLE STITCH	\$45.00	SATIN SHIMMER	\$17.97	SEACROFT	\$32.00
ROLANDO	\$74.97	ROYALWIDE	\$8.00	SADLER	\$33.97	SATIN STITCH	\$34.00	SEAFRONT	\$62.00
ROLLING AHEAD	\$24.00	RUALA	\$62.00	SAFARI DAYS	\$38.00	SATIN SWIRLS	\$48.00	SEAL HARBOR	\$74.00
ROLLING CHAIN	\$28.00	RUBINA	\$42.00	SAFARI ROOM	\$40.00	SATIN TREAD	\$32.00	SEARCH LINES	\$25.00
ROLLING STRIPE	\$50.00	RUFFLED ROUCHE	\$18.00	SAGAVID	\$30.00	SATIN TRELIS	\$40.00	SEASIDE INN	\$39.00
ROLLING WAVES	\$43.97	RUFO	\$56.00	SAGITTAL	\$39.00	SATISFACTION	\$36.00	SEASON ROAD	\$22.00
ROMAN CIRCLE	\$60.00	RUGGIERO	\$68.00	SAHIA FLORA	\$25.00	SAUNTON	\$40.00	SEAVEY ISLAND	\$38.00
ROMAN CIRCLE BK	\$66.00	RUGI	\$54.97	SAILOR LINES	\$25.00	SAVANNAH WAY	\$64.00	SEAVIEW STRIPE	\$30.00
ROMAN TIME	\$22.00	RUIDOSSO	\$62.00	SAKURA	\$56.00	SAVANNAH WEAVE	\$61.97	SEBELIUS	\$44.00
ROMAN VINE	\$48.00	RUKI	\$47.97	SAKURA BLOSSOM	\$38.00	SAVARD	\$71.97	SECOND LOOK	\$44.00
ROMERO	\$65.97	RUMBA DIAMOND	\$59.00	SALAMANDER	\$66.00	SAVILE ROW	\$32.00	SECOND TIME	\$38.97

WHOLESALE TRADE PRICE LIST
800.333.3777

ROBERT ALLEN accepts MasterCard, Visa® and American Express

ROBERT ALLEN

PATTERN	PRICE	PATTERN	PRICE	PATTERN	PRICE	PATTERN	PRICE	PATTERN	PRICE
SECRET BOX	\$52.00	SHEER BOXES	\$55.00	SHOKAN	\$66.00	SIMPLE RUFFLE	\$38.00	SNOWDONIA	\$116.00
SECRET HARBOR	\$35.00	SHEER CHIC	\$38.00	SHONDRA	\$24.00	SIMPLE STAR	\$86.00	SNOWMAN	\$30.00
SECRET PASSAGE	\$80.00	SHEER CIRCLES	\$75.00	SHOREDITCH	\$42.00	SIMPLE STITCH	\$50.00	SNOWPEA	\$45.97
SECRET ROOM	\$24.00	SHEER DAZZLE	\$46.00	SHOREWOOD	\$42.97	SIMPLE TEXTURE	\$25.00	SNUGGLE UP	\$45.00
SECRET WAYS	\$25.00	SHEER DIAMOND	\$79.97	SHORT N STOUT	\$69.97	SIMPLE WAY	\$65.00	SNUGGLEBUG	\$32.00
SECTIONAL	\$25.00	SHEER ENERGY	\$25.00	SHORT ROADS	\$34.00	SIMPLY CHIC	\$20.97	SO PLAIN	\$36.00
SEDALIA	\$42.00	SHEER FLORAL	\$32.00	SHORTCUT	\$42.00	SIMPLY LOOPED	\$61.97	SO QUAIN	\$30.00
SEDIUM	\$110.00	SHEER GLIMMER	\$41.97	SHOUT SPRING	\$30.00	SIMPLY PERFECT	\$68.00	SO SERENE	\$110.00
SEEING SQUARES	\$34.00	SHEER GLORY	\$31.00	SHOW HOUSE	\$20.00	SIMPLY PETALS	\$66.00	SO SILKY	\$40.00
SEFOLOSHA	\$28.00	SHEER LEAVES	\$65.00	SHOW OFF	\$45.97	SIMPLY PLAIN	\$19.00	SOCORRO	\$74.00
SEGMENT	\$56.00	SHEER MADNESS	\$26.00	SHOWRIBBON	\$51.97	SIMPLY REFINED	\$94.97	SOFANOR	\$66.00
SEISMIC LINES	\$77.97	SHEER MAGIC	\$40.00	SHOWTIME	\$41.97	SIMPLY SWIRLED	\$74.00	SOFOCALES	\$66.00
SEISMIC SUN	\$58.00	SHEER PATHS	\$44.00	SHREVEPORT	\$33.97	SIMPLY VELVET	\$51.97	SOFT AND SHINY	\$42.00
SEIWA	\$51.97	SHEER POWDER	\$47.97	SHUBELIC	\$19.95	SINDEL	\$34.00	SOFT BASKET	\$46.00
SEIZMIC	\$19.95	SHEER RAFFIA	\$88.97	SHUFFLE ALONG	\$48.00	SINGING BIRDS	\$61.97	SOFT BLANKET	\$33.97
SELDOVIA CROWN	\$56.00	SHEER RUNWAY	\$20.00	SHURCLIFF	\$40.00	SINGLE FILE	\$40.00	SOFT BLOCKS	\$46.00
SELIG	\$51.97	SHEER SKY	\$54.97	SIDE BY SIDE	\$56.00	SINGLE ROSE	\$67.97	SOFT BREEZE	\$90.00
SELKIRK	\$34.00	SHEER STRIE	\$67.97	SIDELINES	\$61.97	SINGLE STRANDS	\$52.00	SOFT CATCH	\$34.00
SELWYN	\$19.95	SHEER STRIPES	\$45.97	SIDESTRIPES	\$55.00	SINGLE SWEEP	\$25.97	SOFT CHEETAH	\$64.00
SEMIDO	\$30.00	SHEER TRACKS	\$50.00	SIDEWINDER	\$52.00	SINTON	\$39.00	SOFT CHENILLE	\$54.00
SEMINOLE GLORY	\$35.97	SHEFFIELD WAY	\$43.97	SIERRA STRIPE	\$39.00	SIR ALBERT	\$50.00	SOFT COMFORT	\$55.97
SEMPIONE	\$52.00	SHELBY	\$54.97	SIERRAVILLE	\$52.00	SIXPENCE	\$39.00	SOFT CUBES	\$26.00
SENA	\$52.00	SHELL SEEKERS	\$61.97	SIGNIFY	\$78.00	SKAGWAY	\$57.97	SOFT DIAMOND	\$68.00
SENDRA	\$24.97	SHELL TAPE	\$30.00	SILENT GARDEN	\$62.00	SKELLIG	\$58.00	SOFT EDGES	\$64.00
SENSATIONAL	\$43.97	SHELLAC	\$30.00	SILK BLOOMS	\$67.97	SKETCH	\$62.00	SOFT EFFECTS	\$40.00
SENSE OF SPACE	\$55.00	SHELMARTIN	\$74.00	SILK BOX	\$51.97	SKETCHED VINES	\$48.00	SOFT EVENING	\$19.00
SENSIBILITY	\$34.00	SHEM	\$24.00	SILK GINGHAM	\$54.97	SKIN SCENE	\$62.00	SOFT HAND	\$13.00
SENSIBLE	\$57.97	SHERWOOD	\$48.00	SILK GLAMOUR	\$84.97	SKIPTON	\$64.00	SOFT HEX	\$49.00
SENSUEDE	\$111.97	SHETLAND LINE	\$16.95	SILK GRID	\$62.00	SKYLARK	\$62.00	SOFT KEYS	\$26.00
SENSUEDE II	\$114.00	SHETTLESTON	\$34.00	SILK ICICLES	\$37.97	SKYLIGHT	\$41.97	SOFT LEAVES	\$58.00
SERENE LINEN	\$48.00	SHIELDS	\$47.97	SILK MIST	\$61.97	SKYWARD	\$74.00	SOFT LINES	\$40.00
SERENELY COOL	\$52.00	SHIELDS TAVERN	\$46.00	SILK OTTOMAN	\$35.97	SLALOM PLEAT	\$65.00	SOFT MINK	\$74.00
SESSION	\$58.00	SHIFTED STRIPE	\$58.00	SILK PETALS	\$52.00	SLASH LANES	\$59.00	SOFT MOSAIC	\$38.00
SET DANCE	\$66.00	SHIFTING SAND	\$36.00	SILK POETRY	\$48.00	SLATERSVILLE	\$69.97	SOFT N DANDY	\$33.97
SET IN STONE	\$82.00	SHIFTING WAVE	\$83.97	SILK SWIRLS	\$67.97	SLIDE SHOWS	\$45.00	SOFT N PLAIN	\$30.00
SET SAIL	\$24.00	SHIMADZU	\$30.00	SILK TAFFETA	\$33.97	SLIDING LINES	\$42.00	SOFT NET	\$20.00
SEVERINE	\$70.00	SHIMMER GOLD	\$32.00	SILK WEAVE	\$62.00	SLIGO	\$62.00	SOFT PAISLEY	\$59.00
SEVIGNY	\$48.00	SHIMMER QUILT	\$48.00	SILKEN LEAVES	\$74.00	SLING BACK	\$43.97	SOFT PALLET	\$25.00
SEWING CORNER	\$52.00	SHIMMER SHINE	\$25.00	SILKEN PLAID	\$40.00	SLINKY	\$25.00	SOFT ROADS	\$47.00
SHADAY	\$57.97	SHIMMER SOLID	\$25.00	SILKETTE	\$74.00	SLITHER	\$42.00	SOFT RUSH	\$73.97
SHADBERRY	\$61.97	SHIMMER SQUARE	\$31.97	SILKY LOOK	\$58.00	SLUG BUG	\$58.00	SOFT SCULPTURE	\$76.00
SHADOW LEAF	\$36.00	SHIMMER STITCH	\$58.00	SILKY SLUB	\$38.00	SMALL OGEE	\$38.00	SOFT SHADES	\$34.00
SHADOW MIX	\$36.97	SHIMMERS	\$65.00	SILKY SMOOTH	\$74.00	SMALL PAISLEY	\$48.00	SOFT SPARKLE	\$45.97
SHADOW ROOTS	\$72.00	SHINE BRIGHTLY	\$46.00	SILLY STRING	\$25.00	SMALL SPACES	\$26.00	SOFT SQUARES	\$49.00
SHADOW TRELLIS	\$58.00	SHINE SOFTLY	\$26.00	SILVER COAST	\$79.97	SMART LINES	\$61.97	SOFT STITCH	\$24.97
SHADOW VINES	\$34.00	SHINE THROUGH	\$52.00	SILVER DAWN	\$78.00	SMIRK	\$35.00	SOFT STRIE	\$49.00
SHADWELL	\$59.00	SHINING BRIGHT	\$75.00	SILVER FUSION	\$35.97	SMOOTH MOVE	\$56.00	SOFT STRIPES	\$74.00
SHADY SITE	\$52.00	SHINY MEADOW	\$32.00	SILVER LINING	\$42.00	SMOOTH SAILING	\$49.00	SOFT STROKE	\$75.00
SHADY WAYS	\$36.00	SHINY PAISLEY	\$32.00	SILVER THREADS	\$79.00	SMOOTH SOLID	\$26.00	SOFT SUBLIME	\$42.00
SHAINA	\$42.00	SHINY SQUARES	\$42.00	SIMPLE ARMOR	\$30.00	SMOOTH STITCH	\$40.00	SOFT SUEDE	\$77.97
SHAKER HILLS	\$36.00	SHINY STITCHES	\$55.97	SIMPLE ARRAY	\$65.00	SMOOTH STRIPE	\$26.00	SOFT TONES	\$68.00
SHARNE	\$42.00	SHINY STRIPE	\$26.00	SIMPLE COMFORT	\$30.00	SMOOTH SUEDE	\$26.00	SOFT VELVET	\$56.00
SHARON GROVE	\$51.97	SHINY THREADS	\$59.00	SIMPLE CURVE	\$35.00	SNAKE CHAIN	\$59.00	SOFT VINES	\$62.00
SHARPE	\$65.97	SHINY WEAVE	\$62.00	SIMPLE DOTS	\$45.00	SNAKE RANGE	\$48.00	SOFTENED SOLID	\$68.00
SHASTA	\$24.97	SHIPSWAY	\$25.00	SIMPLE FLOWERS	\$30.00	SNAPPY SWIRLS	\$19.00	SOFTY ROW	\$53.97
SHEBA WAY	\$52.00	SHISO	\$83.97	SIMPLE LINES	\$41.97	SNAZZY	\$28.00	SOHO VELVET	\$48.00
SHEDAISY	\$56.00	SHIVALI	\$72.00	SIMPLE PLEATS	\$67.97	SNOW FOX	\$74.00	SOIREE	\$77.97
SHEER ACCESS	\$55.00	SHOJI	\$57.97	SIMPLE ROAD	\$25.00	SNOW HILL	\$52.00	SOL	\$52.00

WHOLESALE TRADE PRICE LIST
800.333.3777

ROBERT ALLEN accepts MasterCard, Visa® and American Express

ROBERT ALLEN

PATTERN	PRICE	PATTERN	PRICE	PATTERN	PRICE	PATTERN	PRICE	PATTERN	PRICE
SOLAR DAWN	\$54.00	SPECTR MINI CRD	\$6.00	SPRING WEAVE	\$47.97	STATIC ROW	\$25.97	STRAIGHT SHOT	\$38.00
SOLAR WIND	\$56.00	SPECTR RIB CORD	\$10.00	SPRINGPORT	\$72.00	STATIM	\$40.00	STRAIGHT TALK	\$61.97
SOLID BAND	\$9.00	SPECTR ROUCH LP	\$16.00	SPRINKLED DOTS	\$46.00	STATOSKY	\$77.97	STRAIGHT VIEW	\$28.00
SOLID BASE	\$32.00	SPECTR TASSL FR	\$40.00	SPRITZ	\$50.00	STAVROS	\$75.00	STRAIGHTAWAY	\$70.00
SOLID CORD	\$13.97	SPECTR TIEBACK	\$62.00	SPROUTING VINE	\$58.00	STAY CONNECTED	\$42.00	STRANDHILL	\$36.00
SOLID GLITTER	\$56.00	SPEED WAY	\$38.00	SPRUCE CANYON	\$45.00	STEARNCREST	\$77.97	STRATHAM	\$44.00
SOLID JAMMIN	\$49.00	SPEZIA	\$74.97	SPUNKY STRIPE	\$36.00	STEEL HEART	\$43.97	STRATHSPEY	\$34.00
SOLID LINES	\$52.00	SPHERICAL	\$46.00	SPUNKY WEAVE	\$34.00	STEEP HILL	\$62.00	STRAVATO	\$75.97
SOLID LIP CORD	\$13.97	SPICE MARKET	\$130.00	SQUARE BLOCKS	\$78.00	STEEPLE BAY	\$48.00	STREAMING	\$34.00
SOLID SHINE	\$26.00	SPIDER WEB	\$37.00	SQUARE CIRCLES	\$48.00	STELLALUNA	\$63.97	STREAMING WAVE	\$36.00
SOLID SPRAY	\$25.00	SPINDLE	\$54.97	SQUARE CONCEPT	\$58.00	STELLAR LIGHT	\$42.97	STREET WAY	\$32.00
SOLID STITCH	\$38.00	SPINDLE DOTS	\$57.97	SQUARE DOTS	\$26.00	STENCILED BEAM	\$40.00	STREHLE	\$54.00
SOLID STRIE	\$71.97	SPINDRIFT	\$54.97	SQUARE LINK	\$52.00	STEP BY STEP	\$61.97	STREIFEN	\$24.97
SOLID WEAVE	\$24.00	SPIRAL CENTER	\$55.00	SQUARE MAZE	\$32.00	STEP TRELIS	\$30.00	STRETCHED OUT	\$81.97
SOLITARY	\$46.00	SPIRAL LOOP	\$52.00	SQUARE TEXTURE	\$19.00	STEPHANA	\$31.97	STREWN LEAVES	\$54.97
SOLMAR	\$51.97	SPIRAL PATH	\$68.00	SQUARED COLOR	\$42.00	STEPPING OUT	\$59.00	STRIA	\$78.00
SOLOMIO	\$46.00	SPIRAL WHEEL	\$42.00	SQUARED LEAF	\$48.00	STEPPING UP	\$52.00	STRIA WAVES	\$58.00
SOMERSET RANGE	\$58.00	SPIRALGRAPH	\$81.97	SQUARED UP	\$19.95	STETSON	\$31.97	STRIE BRAID	\$36.00
SONIA	\$51.97	SPIRITAS	\$54.97	SQUARESIDE	\$58.97	STICKPIN	\$72.00	STRIE FLEUR	\$25.00
SONIC BOOM	\$38.00	SPIROGRAPH	\$52.00	SQUIGGLE IT	\$39.00	STILL FLOWERS	\$24.00	STRIE SPARKLE	\$22.00
SONIC RIPPLE	\$36.00	SPLASH	\$32.00	SQUIGGLE LINES	\$42.00	STILL LEAVES	\$46.00	STRIE STRIPE	\$58.97
SONIC SPRAY	\$80.00	SPLASH ABOUT	\$74.00	SQUIGGLE SNAKE	\$57.97	STILLMATIC	\$61.97	STRIE VELVET	\$48.00
SOOTHING	\$34.00	SPLASHACATA	\$28.00	SQUIRE ROAD	\$48.00	STITCH ACROSS	\$84.00	STRIKE A POSY	\$37.97
SOPHIA RANGE	\$75.00	SPLINTER	\$84.00	ST ANDREWS	\$43.97	STITCH ALONG	\$48.00	STRING DAISY	\$43.97
SORBARA	\$42.00	SPLIT LEAVES	\$58.00	ST AUGUSTINE	\$46.00	STITCH EFFECT	\$24.00	STRING GAMES	\$34.00
SORBONNI	\$75.97	SPLIT RAILS	\$39.00	ST PIERRE	\$34.00	STITCH IN TIME	\$26.00	STRIPE ALONG	\$38.00
SOSSANO	\$56.00	SPLIT SQUARES	\$16.00	ST TROPEZ	\$32.00	STITCH WORK	\$30.00	STRIPE LANE	\$30.00
SOTERO	\$52.00	SPLIT TRIANGLE	\$42.97	STACKED APEX	\$54.00	STITCHED BLOCK	\$55.00	STRIPE STITCH	\$40.00
SOUL MATE	\$67.97	SPONGEE	\$56.00	STACKING BOXES	\$68.97	STITCHED BOXES	\$32.00	STRIPE WITHIN	\$48.00
SOUND BOARD	\$65.97	SPONTANEOUS	\$52.00	STACY LYN	\$42.00	STITCHED CHECK	\$55.00	STRIPED AFFAIR	\$44.00
SOUTH COAST	\$19.95	SPOOL SPIN	\$52.00	STAFFORDSHIRE	\$63.97	STITCHED HEX	\$40.00	STRIPED BOXES	\$61.97
SOUTH MESA	\$69.97	SPOTTED COAT	\$82.00	STAINED GLASS	\$54.00	STITCHED LEAVES	\$52.00	STRIPED CORD	\$68.00
SOUTH PARK	\$51.97	SPOTTED DOG	\$30.00	STAIR TREADS	\$42.00	STITCHED ROAD	\$25.00	STRIPED DECOR	\$24.00
SOUTHBANK	\$25.00	SPOTTED GLORY	\$80.00	STAMPED DESIGN	\$72.00	STITCHED WAYS	\$36.00	STRIPED LINES	\$28.00
SOUTHDOWN	\$32.00	SPOTTED LANE	\$56.00	STANDBY	\$29.00	STITCHINGS	\$65.97	STRIPED LOOK	\$48.00
SOUTHERN WIND	\$32.00	SPOTTED LEO	\$78.00	STANLEY PARK	\$42.00	STOIC	\$25.00	STRIPED NET	\$54.97
SOWERSBY	\$57.97	SPRINDEW	\$54.97	STANTON SQUARE	\$48.00	STONAGE	\$67.97	STRIPED PAJAMA	\$26.00
SPACED LINES	\$19.95	SPRING AHEAD	\$28.00	STAR APPEAL	\$43.97	STONE AGE	\$58.00	STRIPED SUEDE	\$97.97
SPACED OUT	\$45.00	SPRING AIR	\$64.00	STAR CREST	\$81.97	STONE EFFECT	\$34.00	STRIPED TAPE	\$15.00
SPARKLE CUBE	\$51.97	SPRING BLOSSOM	\$58.97	STAR FISH	\$25.00	STONE FRAGMENT	\$45.00	STRIPES GALORE	\$30.00
SPARKLE STRIPE	\$27.97	SPRING BUDS	\$75.97	STAR LIGHT	\$25.97	STONE LUXE	\$32.00	STRIPING	\$28.00
SPARKLE THREAD	\$71.97	SPRING CHEER	\$30.00	STAR MAPS	\$62.00	STONE MANOR	\$39.00	STROME	\$11.97
SPARKLING EDGE	\$49.00	SPRING DEW	\$20.00	STAR POWER	\$78.00	STONE WALL	\$61.97	STRONG BEAT	\$51.97
SPEARHEAD	\$44.00	SPRING ESTATE	\$34.00	STAR SEARCH	\$77.97	STONEBARROW	\$22.00	STRUMMED	\$28.00
SPEARS	\$28.00	SPRING FANCY	\$58.00	STAR SIGHTING	\$84.00	STONEGROUND	\$172.00	STUNNING PATH	\$34.00
SPECKLE ROAD	\$32.00	SPRING FEST	\$45.97	STAR TIME	\$52.00	STONEHOUSE	\$62.00	STYLISH LEAVES	\$66.00
SPECKLED BEADS	\$73.97	SPRING FEVER	\$64.00	STARBURY	\$36.00	STONERIDGE	\$24.00	STYLISH STITCH	\$94.97
SPECKLED DOTS	\$40.97	SPRING FOLIAGE	\$55.00	STARGAZER GLOW	\$42.00	STONYBROOK	\$31.97	STYLISH STRIPE	\$62.00
SPECKLED FUN	\$44.00	SPRING FORUM	\$26.00	STARINA	\$52.00	STORM	\$75.97	STYRIA	\$26.00
SPECKLED LANE	\$29.00	SPRING PAISLEY	\$67.97	STARION	\$52.00	STORMY SKY	\$52.00	SUAVE SOLID	\$32.00
SPECKLED SOLID	\$67.97	SPRING PEEPERS	\$64.00	STARS ALIGN	\$25.00	STORY STONES	\$52.00	SUBLIME	\$61.97
SPECKLES	\$72.00	SPRING PLAID	\$65.97	STARSIA AV	\$20.97	STORYVILLE	\$48.00	SUBSCRIPT	\$70.00
SPECTR BRAID	\$22.00	SPRING PLANTS	\$39.00	STARVISH	\$62.00	STOUGHTON	\$33.97	SUBTLE MOOD	\$25.00
SPECTR BRUSH FR	\$18.00	SPRING PROMISE	\$62.00	STARWOOD	\$88.00	STRAHAN	\$57.97	SUBTLE SHINE	\$46.00
SPECTR CHAIR T	\$58.00	SPRING RAIN	\$42.00	STATE LINE	\$52.00	STRAIGHT AHEAD	\$48.00	SUBTLY MODERN	\$39.00
SPECTR CORD LIP	\$8.00	SPRING SQUARE	\$36.00	STATE ROOM	\$49.97	STRAIGHT LINE	\$40.00	SUDAN BAND	\$36.00
SPECTR GIMP	\$9.00	SPRING VALLEY	\$37.97	STATE STREET	\$39.00	STRAIGHT ON	\$55.00	SUDDEN IMPACT	\$38.00
SPECTR KEY TSL	\$30.00	SPRING WALK	\$38.00	STATFORD SQ	\$30.00	STRAIGHT PATH	\$34.00	SUE ELLEN	\$51.97

WHOLESALE TRADE PRICE LIST
800.333.3777

ROBERT ALLEN accepts MasterCard, Visa® and American Express

ROBERT ALLEN

PATTERN	PRICE	PATTERN	PRICE	PATTERN	PRICE	PATTERN	PRICE	PATTERN	PRICE
SUEDE CORD	\$14.00	SUTTON RANGE	\$34.00	TAIL FEATHERS	\$51.97	TEMORA	\$54.97	TIE DYE STRIPE	\$48.00
SUEDE SQUARES	\$101.97	SUVARI	\$61.97	TAILORED LINES	\$32.00	TENAR	\$68.00	TIED ROWS	\$52.00
SUEDE TAPE	\$15.00	SVETLANA	\$94.97	TAKE A LETTER	\$77.97	TENCREEK	\$30.00	TIGERTON	\$73.97
SUGURI	\$54.97	SVINDAL	\$54.97	TAKE OFF	\$32.00	TENDER CARE	\$80.00	TIKAL	\$44.00
SUITE	\$15.00	SWALEKEEP	\$71.97	TAKISH	\$42.00	TENNACO	\$29.97	TIKI TORCH	\$45.00
SULTANS PALACE	\$30.00	SWANSEA STRIPE	\$56.00	TALAHACHI	\$70.00	TENT MEETING	\$61.97	TILBY	\$33.97
SULTRY SHEER	\$52.00	SWAYING VINE	\$19.95	TALISMAN	\$63.97	TENTERDEN	\$67.97	TILE PATH	\$40.00
SUMERIA	\$51.97	SWEENY	\$48.00	TALKING POINT	\$52.97	TERBELLUM	\$37.97	TILED	\$44.00
SUMI	\$43.97	SWEET CAROLINE	\$36.97	TALL TALES	\$55.00	TERGAL VOILE DK	\$20.00	TILTING BLOCKS	\$56.00
SUMIDA	\$59.00	SWEET DOTS	\$25.00	TALLAHASSEE	\$30.00	TERMINAL	\$38.00	TIMBERLAND	\$134.00
SUMMATION	\$49.00	SWEET DREAMS	\$36.00	TALLIAN	\$64.97	TERMOLI	\$52.00	TIMBRE	\$14.00
SUMMER BEAUTY	\$74.00	SWEET ESCAPE	\$56.00	TALLULAH BELLE	\$37.97	TERRA MARA	\$68.00	TIME HONORED	\$30.00
SUMMER CAMP	\$34.00	SWEET FLOWER	\$26.00	TALLYMORE	\$33.97	TERRA TOMAH	\$40.00	TIME TRAVEL	\$65.97
SUMMER DAYS	\$53.97	SWEET HONESTY	\$46.00	TALLYRAND	\$100.00	TERRAZZA	\$64.00	TIMELESS	\$88.97
SUMMER DREAM	\$32.00	SWEET IMPRESS	\$24.97	TALORA	\$59.00	TERRELL	\$33.97	TINCTURE	\$114.00
SUMMER GLORY	\$64.00	SWEET JANE	\$51.97	TALULA	\$75.00	TERRITORY	\$77.97	TINTED BATISTE	\$14.00
SUMMER HEAT	\$43.97	SWEET KELSEY	\$52.00	TAM TAM	\$79.00	TESSA	\$27.97	TINTED VIEW	\$28.00
SUMMER MAGIC	\$52.00	SWEET KISS	\$28.00	TAMIKA	\$38.97	TESTAVERDE	\$48.00	TINTED VOILE	\$9.00
SUMMER SCENE	\$32.00	SWEET LOVE	\$28.00	TANA STRIPE	\$64.00	TETHERBALL	\$58.00	TINY CHAINS	\$35.00
SUMMER SIGHT	\$40.00	SWEET NOTHINGS	\$42.00	TANGLE UP	\$44.00	TETHRA	\$39.00	TINY DROP	\$55.00
SUMMER SONG	\$36.00	SWEET PAISLEY	\$28.00	TANGLED PATH	\$19.95	TEXTURE CHECK	\$36.00	TINY LINES	\$51.97
SUMMER STITCH	\$66.00	SWEET PETAL	\$50.00	TANGLES	\$52.00	TEXTURE PATH	\$39.00	TINY PEBBLES	\$36.00
SUMMER SUN	\$71.97	SWEET SOLID	\$24.00	TANITH	\$69.97	TEXTURE SCREEN	\$68.00	TINY PLAID	\$52.00
SUMMER WAVE	\$26.00	SWEET STRIPES	\$47.97	TANIYA	\$88.00	TEXTURE SHAPE	\$48.00	TINY SQUARES	\$62.00
SUMMERS BOUNTY	\$58.00	SWEETBAY SPARK	\$42.00	TANJORE	\$52.00	TEXTURED BLEND	\$29.00	TINY TRINKET	\$65.00
SUMMIT RIDGE	\$63.97	SWEETGRASS	\$48.00	TANNENBAUM	\$59.00	TEXTURED ORB	\$40.00	TINY TULIP	\$77.97
SUMONA	\$64.00	SWIFT CURRENT	\$39.00	TANNERY	\$75.97	TEXTURED PLAID	\$62.00	TIOGA	\$57.97
SUN GLORY	\$38.00	SWIFT STITCH	\$62.00	TANTALIZE	\$56.00	TEXTURED RIB	\$52.00	TIP TOP	\$45.00
SUN SETTING	\$32.00	SWIFT TEXTURE	\$29.00	TAPACHULA	\$62.00	TEXTURED TAPE	\$19.00	TIPPERARY HILL	\$68.00
SUNBURST	\$38.97	SWIM SUITS	\$58.00	TAPANI	\$11.97	TEXTURED WEAVE	\$70.00	TIRA VIRTE	\$67.97
SUNBURST COURT	\$22.00	SWINK	\$42.00	TAPAWINGO	\$34.00	THAILYNN	\$25.00	TIRE TRACKS	\$34.00
SUNBURST ROPE	\$30.00	SWIRL ALONG	\$56.00	TAPESTRY FLORA	\$72.00	THAMES RIVER	\$52.00	TIRSO	\$100.00
SUNCROFT	\$37.97	SWIRL AROUND	\$44.00	TAPIR	\$62.00	THATCH WEAVE	\$172.00	TITHERLY	\$47.97
SUNDIAL DAY	\$54.00	SWIRL LANE	\$26.00	TARAMAR	\$73.97	THATCHED	\$25.00	TOGETHER	\$61.97
SUNLAND PARK	\$30.00	SWIRLED CURVES	\$46.00	TARBOX	\$44.97	THE ELMS	\$41.97	TOGO BAND	\$34.00
SUNNINGHILL	\$52.00	SWIRLING HIGH	\$56.00	TARMAK	\$28.00	THE RITZ	\$122.00	TOHONO	\$40.00
SUNNY	\$26.00	SWIRLING LEAF	\$52.00	TARSICIO	\$52.00	THE TRUTH	\$25.00	TOKEN	\$35.00
SUNNY BANKS	\$68.00	SWIRLY SHEEN	\$34.00	TARTAN WEB	\$67.97	THEO	\$54.97	TOKYO STEMS	\$26.00
SUNNY DAYS	\$25.97	SWIRLY THREADS	\$50.00	TASHA	\$61.97	THERIAN	\$61.97	TOLENTINO	\$71.97
SUNNY SITE	\$48.00	SWISS RANGE	\$19.95	TASSEL FRINGE	\$53.97	THERMALSUEDE	\$8.00	TOLLAND	\$47.97
SUNNY SLOPE	\$22.00	SWIVEL AV	\$17.97	TASSEL TIE	\$73.97	THIANA	\$65.97	TOLLGATE	\$59.00
SUNRISE BLVD	\$136.00	SWIVELER	\$40.00	TATUM	\$24.00	THICK AND THIN	\$42.00	TOMBOLA	\$42.00
SUNRISE BURST	\$54.97	SWOONING	\$40.00	TAURUS	\$54.97	THICK LINES	\$56.00	TOMS LOVE	\$48.00
SUNSET BLVD	\$49.00	SWOOPS	\$19.95	TAVAREZ	\$30.00	THIN LINED	\$52.00	TONAL CHENILLE	\$56.00
SUNSET CIRCLE	\$35.00	SYESHA	\$66.00	TAVERN TOILE	\$40.00	THISTLE DOWN	\$56.00	TONAL TWEED	\$30.00
SUNSET GRILL	\$50.00	SYMMETRICAL	\$40.97	TAYASAL	\$74.00	THISTLE GARDEN	\$38.00	TOON GABBLE	\$23.97
SUNSET STRIP	\$48.00	SYNCOPATION	\$35.00	TAYLOR PARK	\$75.00	THORN GROVE	\$69.97	TOP DESIGN	\$65.00
SUNSPOT	\$70.97	SYNDARA	\$28.00	TAYLORMADE	\$22.00	THORNDOM	\$24.00	TOP DRAWER	\$44.00
SUPER STAR	\$19.95	SYNONYMOUS	\$54.97	TAZEWELL	\$78.00	THORSEN	\$34.00	TOP SPEED	\$62.00
SUPERIOR SHORE	\$42.00	SYNTHESIS	\$83.97	TEATRO TOWER	\$80.00	THREAD BARE	\$25.00	TOPACIO	\$33.97
SUPERSUUDE	\$171.97	TABLOID	\$43.97	TECH LINES	\$42.00	THRICE	\$34.00	TOPIARY BALL	\$72.00
SURF CASTING	\$73.97	TABOO	\$16.00	TECHNO FASHION	\$52.00	THUNDERHEAD	\$36.00	TOPIARY BASKET	\$57.97
SURFS UP	\$42.97	TAG ALONG	\$45.00	TEEPEE TENT	\$40.00	THURSTON	\$47.97	TOPNOTCH	\$54.00
SURMELIS	\$39.97	TAHARI	\$52.00	TEKENING	\$44.00	TIA	\$14.97	TOPSY TURVY	\$35.97
SURROGATE	\$52.00	TAHOE	\$48.97	TEKOA	\$44.00	TICKER RAIL	\$26.00	TORNELLE	\$37.97
SUSANVILLE	\$41.97	TAHOE STRIPE	\$63.97	TELARANA	\$56.00	TICKING	\$22.00	TORO	\$75.97
SUSTAIN	\$80.00	TAHOMA	\$55.00	TELEMACO	\$45.00	TICKING ALONG	\$34.00	TORPOINT	\$58.00
SUTOKU	\$39.97	TAIA	\$69.97	TELEVISION	\$52.00	TICKING STRIPE	\$46.00	TORTOLA BAY	\$14.97

WHOLESALE TRADE PRICE LIST
800.333.3777

ROBERT ALLEN accepts MasterCard, Visa® and American Express

ROBERT ALLEN

PATTERN	PRICE	PATTERN	PRICE	PATTERN	PRICE	PATTERN	PRICE	PATTERN	PRICE
TOTARA FLATS	\$74.00	TRINITY	\$48.00	TWEED	\$61.97	UNIONVILLE	\$75.97	VELVET DIAMOND	\$87.97
TOTTENHAM	\$45.00	TRINITY KNOT	\$84.00	TWEED CHECK	\$42.00	UNIQUE DIAMOND	\$58.00	VELVET HIDCOTE	\$55.00
TOWER BRIDGE	\$25.00	TRIO BLOCKS	\$58.00	TWEED CHENILLE	\$56.00	UNIQUE DOTS	\$54.00	VELVET LINGE	\$80.00
TOWER HILL	\$40.00	TRIONA	\$62.00	TWEED MULTI	\$34.00	UNIQUE FLORAL	\$42.00	VELVET MAZE	\$89.00
TOWNLIN	\$41.97	TRIPLE DIAMOND	\$61.97	TWIG TOSS	\$38.00	UNIQUE FLOWER	\$36.00	VELVET PLAIN	\$53.97
TOWNSHIP	\$73.97	TRIPLE UP	\$28.00	TWIGGY	\$33.97	UNIQUE IMPRINT	\$28.00	VELVET ROPE	\$68.00
TRACING	\$42.00	TRIPLE WEAVE	\$44.00	TWILIGHT HOURS	\$30.00	UNIQUE LEAVES	\$19.00	VELVET SHEEN	\$19.97
TRACING NATURE	\$42.00	TRISCELE	\$55.00	TWILL WORKS	\$54.00	UNIQUE LINES	\$16.00	VELVET SHIMMER	\$87.97
TRACK	\$58.00	TRISSEL	\$35.00	TWIN HILLS	\$51.97	UNIQUE PLAID	\$48.00	VELVET SQUARE	\$71.97
TRAD BEAD FRING	\$36.00	TRIXIE SUE	\$37.97	TWIN LAKES	\$99.00	UNIQUE SHAPES	\$44.00	VELVET TAPE	\$19.00
TRAD BRAID	\$16.00	TROCAIRE	\$71.97	TWIN SHORES	\$79.00	UNIQUE STRIPE	\$54.97	VELVET TASSEL	\$78.00
TRAD BRUSH	\$19.00	TROMSO STRIPE	\$58.00	TWIN STRIPES	\$40.00	UNIQUE TEXTURE	\$19.95	VELVET TRIM	\$87.97
TRAD BULLION	\$38.00	TRONDHEIM	\$42.00	TWIN THREADS	\$72.00	UNIQUE WAY	\$32.00	VELVET TWIX	\$94.00
TRAD CHAIR TIE	\$28.00	TROPIC STORM	\$74.00	TWINING LEAVES	\$48.00	UNITED VINES	\$58.00	VENDELLA	\$25.00
TRAD CORD	\$9.00	TROPICAL GEMS	\$35.00	TWINKLE TIME	\$46.00	UNSCRIPTED	\$59.00	VENETTI	\$58.00
TRAD KEY TASSEL	\$16.00	TROPICAL LEAF	\$44.00	TWINKLING	\$45.00	UNTIL DAWN	\$62.00	VENETIAN WAY	\$78.00
TRAD MINI CORD	\$6.00	TROPICAL OASIS	\$46.00	TWINSBURG	\$52.00	UNWRITTEN	\$42.00	VENEZIA BRAID	\$37.97
TRAD TAPE	\$9.00	TROPICAL VINE	\$20.00	TWIST	\$23.97	UP UP AND AWAY	\$77.97	VENEZIA BULLION	\$79.97
TRAD TASSEL FRG	\$28.00	TROPICAL WEAVE	\$69.97	TWIST AND TURN	\$25.00	UPGRADE	\$55.00	VENEZIA CHAIR	\$48.97
TRAD TIEBACK	\$40.00	TROTTIER	\$36.00	TWIST AROUND	\$68.00	UPLIFTING HUES	\$58.00	VENEZIA CORDLG	\$16.00
TRADEWINDS	\$64.97	TROUBLE	\$40.00	TWIST N SHOUT	\$62.00	UPSTREAM	\$30.00	VENEZIA CORDSM	\$11.97
TRAFUL	\$52.00	TROVATO	\$33.97	TWISTED KNOT	\$44.97	UPTOWN TWEED	\$55.00	VENEZIA EYELSH	\$21.97
TRAIL MAZE	\$61.97	TRUE	\$51.97	TWISTED ROPE	\$56.00	URBAN CHIC	\$49.97	VENEZIA FRINGE	\$30.00
TRAILING ALONG	\$28.00	TRUE FAVORITE	\$42.00	TWISTED TOFFEE	\$38.00	URBAN STRIPE	\$70.00	VENEZIA KEY	\$27.97
TRAMORE II	\$12.00	TRUE GLOW	\$65.00	TWISTY LANCES	\$48.00	URBAN TRAIL	\$22.00	VENEZIA ROPE	\$61.97
TRANCE	\$33.97	TRUE LINES	\$34.00	TWO LANES	\$64.00	URSELLA	\$71.97	VENEZIA ROUCHE	\$33.97
TRANQUIL FLOWER	\$49.00	TRUE STRIPES	\$30.00	TWO STEP	\$41.97	VACATION PLUSH	\$75.00	VENEZIA TASSEL	\$65.97
TRANSFORMATION	\$78.00	TRUFANT	\$61.97	TWO TASSEL	\$37.97	VALARELLI	\$40.00	VENEZIA TIEBCK	\$98.97
TRANSMIT	\$74.00	TRURO	\$60.00	TWO TONE	\$66.00	VALEDICTORIAN	\$77.97	VENINI	\$72.00
TRANSOM	\$64.97	TRY POINT	\$30.00	TYGART	\$54.97	VALEMONT	\$46.00	VENTRY	\$74.00
TRAPPER	\$36.00	TSANGS GARDEN	\$28.00	TYNGSBORO	\$62.00	VALENCAY	\$38.97	VENUS TRANSIT	\$30.00
TREADS	\$26.00	TUAM	\$40.97	TYRESE	\$78.00	VALENCIA WAY	\$66.00	VERACIOUS	\$54.97
TREANNA	\$92.00	TUBAL	\$45.00	UDAIPUR	\$62.00	VALESKA FLORA	\$52.00	VERACRUZ	\$62.00
TREASURE BEACH	\$20.00	TUBBERCURRY	\$30.00	UILEANN	\$36.00	VALLEY PARK	\$71.97	VERDANT	\$95.00
TREASURE HUNT	\$52.00	TUBULAR WAVE	\$40.00	ULTIMA	\$14.00	VALLEY ROAD	\$22.00	VEREN	\$52.00
TREASURED TIME	\$61.97	TUCKED FRAME	\$42.00	ULTIMATE LOOK	\$58.00	VALLEY SUITES	\$50.00	VERITY ANN	\$28.00
TREE BARK	\$55.00	TUDOR COURT	\$45.00	ULTIMATE SHADE	\$52.00	VALLEY VIEW	\$24.00	VERNON ESTATE	\$74.00
TREE BLOSSOM	\$70.00	TUDOR GROVE	\$68.00	ULTRA CREWEL	\$82.00	VALLIERE	\$46.00	VERONIQUE	\$69.97
TREE BRANCH	\$50.00	TUDRIC	\$77.97	ULTRA LINES	\$32.00	VALQUETTE	\$73.97	VERTICAL STEMS	\$36.00
TREE LEAVES	\$40.00	TUFTED FLOWER	\$66.00	ULTRA SMOOTH	\$34.00	VAMANIS	\$67.97	VERTICAL WAVE	\$77.97
TREE OF LIFE	\$46.00	TULIKA STRIPE	\$46.97	ULTRASOFT	\$72.00	VAMP	\$29.00	VESOUL	\$58.00
TREGARTON PARK	\$30.00	TUMBLE LEAF	\$77.97	ULTRASUEDE-HP54	\$138.97	VAN BUREN	\$31.97	VESPERTINE	\$54.00
TRELEW	\$56.00	TUMCO	\$77.97	UMBRELLA TREE	\$62.00	VANGALI	\$62.00	VESSELLA	\$93.97
TRELLIS TASSELS	\$36.00	TURBO CHARGE	\$42.00	UNAGI	\$40.00	VANSBORO	\$70.00	VESTIGE	\$38.00
TRELLIS TWIST	\$74.00	TURF TIME	\$58.00	UNANIMOUS	\$23.97	VAPOR CAPER	\$104.00	VETRALLA	\$52.00
TRELLIS WORK	\$43.97	TURIN	\$19.97	UNCHAIN	\$38.00	VAREK	\$74.97	VEVAY GARDEN	\$19.97
TREMONT STREET	\$32.00	TURLOUGH	\$55.00	UNCLE JOE	\$55.00	VARIAN	\$28.97	VIA VENETA	\$25.00
TRENDY LOOK	\$64.00	TURN OUT	\$70.00	UNDER A SPELL	\$32.00	VARIOUS	\$25.00	VIANCA	\$40.00
TRENTON	\$88.97	TURNING POINT	\$48.00	UNDERBRUSH	\$50.00	VAVASSEUR	\$52.00	VIANI	\$62.00
TRESEMME	\$56.00	TURNPIKE	\$61.97	UNDERLINE	\$52.00	VEILED	\$62.00	VIBRANT SCENE	\$30.00
TRESSA	\$47.97	TURTLE BAY	\$40.00	UNDERSTATED	\$42.00	VELICATE	\$48.97	VIBRANT STRIPE	\$38.00
TRIANGLE GRID	\$38.00	TURTLE LANE	\$75.97	UNDERSTUDY	\$68.00	VELOUR GIMP	\$26.00	VICARAGE	\$54.00
TRIANGLE SHIFT	\$58.00	TURTLE POND	\$75.97	UNDULATION	\$44.00	VELOUR SCROLL	\$24.00	VICARIOUS	\$37.97
TRIANGULATION	\$49.00	TURTLE SHELL	\$46.00	UNEXPECTED	\$75.97	VELVET BLISS	\$69.00	VICENZA	\$44.00
TRIBAL CHANCE	\$42.00	TUSCAN ZEBRA	\$32.00	UNEXPECTED II	\$80.00	VELVET BRAID	\$26.00	VICHADA	\$44.00
TRILLION	\$27.97	TUSCARORA	\$35.97	UNION CHENILLE	\$57.97	VELVET CIRCLE	\$68.00	VICTORIA ISLE	\$48.00
TRIMMEL	\$43.97	TUSCULUM	\$40.00	UNION PARK	\$24.00	VELVET COLUMNS	\$87.97	VIDOR	\$28.00
TRINITA	\$38.97	TUTTI FRUITTI	\$65.97	UNIONTOWN	\$6.00	VELVET DAZE	\$21.97	VILLA BAND	\$63.97

WHOLESALE TRADE PRICE LIST
800.333.3777

ROBERT ALLEN accepts MasterCard, Visa® and American Express

ROBERT ALLEN

PATTERN	PRICE	PATTERN	PRICE	PATTERN	PRICE	PATTERN	PRICE	PATTERN	PRICE
VILLA BRAID	\$25.97	VOLINIA	\$71.97	WAYSIDE GARDEN	\$74.00	WIDE-GUARD	\$9.00	WOODGRAIN	\$61.97
VILLA BRUSH	\$27.97	VOLTERRA	\$75.00	WEAVE CHECK	\$58.00	WIDELINE	\$63.97	WOODHALL	\$32.00
VILLA CHAIRTIE	\$31.97	VORTEX	\$36.00	WEAVE MODE	\$39.00	WIGGLE PATH	\$52.00	WOODLAND GLORY	\$118.00
VILLA CORD	\$23.97	VUITTON	\$79.00	WEAVE ROAD	\$24.00	WIGWAM	\$69.97	WOODPORT	\$57.97
VILLA FRINGE	\$48.97	WAFFLE BOUCLE	\$48.00	WEAVE WORKS	\$62.00	WILCO	\$54.97	WOODRIDGE	\$65.97
VILLA GROVE	\$40.00	WAGON WHEELS	\$39.00	WEAVER WEB	\$32.00	WILD BOUCLE	\$67.97	WOODVILLE	\$14.00
VILLA HERMOSA	\$34.00	WAITSFIELD	\$40.97	WEAVING ALONG	\$36.00	WILD CIRCLES	\$54.00	WOODWAY	\$41.97
VILLA KEY	\$47.97	WALDEN POND	\$36.00	WEAVING DOTS	\$62.00	WILD COAST	\$38.00	WOOL CHEVRON	\$49.00
VILLA LIP	\$23.97	WALDENWICH	\$67.97	WEAVING LINES	\$49.00	WILD EXTREMES	\$65.00	WOOL FLANNEL	\$90.00
VILLA MINI CORD	\$19.97	WALK ABOUT	\$39.00	WEAVING LOOPS	\$48.00	WILD GARDEN	\$40.00	WOOL SUIT	\$74.00
VILLA MINI LIP	\$22.00	WALKERS POINT	\$79.00	WEB WORK	\$34.00	WILD JOURNEY	\$52.00	WOOL TWILL	\$42.00
VILLA ROSETTE	\$31.97	WALKING MAZE	\$19.95	WEBBERVILLE	\$42.00	WILD OASIS	\$60.00	WOOL VELVET	\$64.00
VILLA TAPE	\$23.97	WALKING PATH	\$28.00	WEBTASTIC	\$52.00	WILD PAISLEY	\$36.00	WOONSOCKET	\$54.97
VILLA TASSELS	\$48.97	WALL STREET	\$50.00	WEDDING BANDS	\$47.97	WILD RICE	\$48.00	WORLD CLIQUE	\$36.00
VILLA TIEBACK	\$163.97	WALLANDER	\$67.97	WEDDING PETALS	\$23.97	WILD SQUARES	\$48.00	WORLD TOUR	\$45.00
VILLA TRIM	\$75.97	WALLFLOWER	\$35.97	WEDGEPORT	\$25.97	WILDE	\$46.00	WOVEN BAND	\$44.97
VILLA VISCAYA	\$78.00	WALTRIP	\$36.00	WEE DOTS	\$45.00	WILDER	\$59.00	WOVEN BLISS	\$42.00
VILLAGE PLAID	\$52.00	WALTZING VINE	\$79.97	WEELEY	\$38.00	WILEY	\$62.00	WOVEN BOXES	\$65.97
VILLAGE VIEW	\$69.97	WALWORTH	\$48.00	WEINBERG	\$89.97	WILLABY	\$75.97	WOVEN BRAID	\$42.00
VINA LA ROSA	\$54.97	WANOKA	\$59.00	WELCOMING HUES	\$22.00	WILLAMANTIC	\$58.00	WOVEN CORD	\$48.97
VINCOLI	\$67.97	WARM CHECKS	\$32.00	WELKER	\$12.00	WILLIAMSON	\$88.97	WOVEN CREST	\$65.97
VINE BLOSSOM	\$36.00	WARM COLORS	\$52.00	WELSH SPRINGS	\$48.00	WILLOW BREEZE	\$20.00	WOVEN CROSSING	\$61.97
VINE BRAID	\$42.00	WARM FLOWER	\$40.00	WEMBLEY	\$172.00	WILLOW CREEK	\$61.97	WOVEN GARDEN	\$40.00
VINE ROMANCE	\$72.00	WARM PAISLEY	\$67.97	WENDYS DREAM	\$28.00	WILLOW FLOWERS	\$88.00	WOVEN GEO	\$78.00
VINE SHIFTER	\$44.00	WARM PLAID	\$45.00	WESSON	\$37.97	WILLOW PARK	\$24.00	WOVEN LADDER	\$42.00
VINE STITCH	\$48.00	WARM ROAD	\$65.97	WEST BEACH	\$30.00	WILLOW RUN	\$42.00	WOVEN LEAVES	\$62.00
VINE STREET	\$42.00	WARM SHIMMER	\$66.00	WEST DAKOTA	\$77.97	WILLOW TREE	\$58.00	WOVEN SHIMMER	\$27.00
VINETTA	\$14.00	WARM STRIPES	\$55.00	WEST SUMMIT	\$52.00	WILLOW WISP	\$26.00	WOVEN STITCH	\$42.00
VINEY LINES	\$42.00	WARM SWEATER	\$24.00	WESTBOURNE	\$35.00	WILLOWMEAD	\$38.00	WOVEN TWEED	\$38.00
VINEYARD HAVEN	\$60.00	WARM WOODS	\$34.00	WESTERLAND	\$30.00	WIND CHIME	\$52.00	WOVEN WAYS	\$38.00
VINTAGE BORDER	\$37.97	WARMER DAYS	\$22.00	WESTERLY	\$34.00	WINDING LEAVES	\$44.00	WOVEN WICKER	\$55.97
VINTAGE FEATHER	\$37.97	WASATCH	\$32.00	WESTMARK	\$61.97	WINDING ROAD	\$45.00	WREATH VINE	\$52.00
VINTAGE GARDEN	\$28.00	WASHED ASHORE	\$73.97	WESTMINSTER	\$71.97	WINDING TRAILS	\$16.00	WRENWOOD	\$48.97
VINTAGE LEAVES	\$51.97	WASHED FLORAL	\$77.97	WESTON STRIPE	\$36.00	WINDING UP	\$46.00	WRINKLES	\$96.00
VINTAGE LIPCORD	\$14.97	WASSER	\$28.00	WETHERBURNS	\$42.00	WINDOW GLITZ	\$58.00	WYOMING	\$25.97
VINTAGE LOOK	\$49.00	WATCHER	\$45.00	WEXFORD BOYS	\$66.00	WINDRIDGE HILL	\$54.97	X-RAY VISION	\$26.00
VINTAGE MODERN	\$40.00	WATERCRESS WAY	\$45.00	WHEAT STREET	\$62.00	WINDROSE	\$52.00	YAMAGUCHI	\$29.97
VINTAGE PLAID	\$32.00	WATERDROPS	\$75.00	WHEELER PARK	\$78.97	WINDSCAPE	\$60.00	YANG	\$78.97
VINTAGE PLUMES	\$55.00	WATERGATE BAY	\$25.00	WHELAN	\$26.00	WINDSOR LOCKS	\$42.00	YARE FIELD	\$74.97
VINTAGE SCROLL	\$77.97	WATERLINE	\$74.00	WHIMSY CIRCLE B	\$22.95	WINDSOR WAY	\$32.00	YARN BURST	\$34.00
VINTAGE STRIPE	\$32.00	WATERLOO	\$44.00	WHIPPER WHIRL	\$66.00	WINDY CITY	\$61.97	YARN LINES	\$55.00
VINTAGE TIEBACK	\$107.97	WATERPLACE	\$34.97	WHISKERS	\$47.97	WING SPAN	\$65.97	YARN ORBITS	\$28.00
VIP	\$109.00	WATERSON	\$38.97	WHISPER SOFT	\$25.00	WINKLER BAY	\$52.00	YAWKEY WAY	\$48.00
VIPER CLUB	\$78.00	WATERTOWN	\$42.00	WHISPER SWIRL	\$72.00	WINNING CHOICE	\$58.00	YELLOW PATCH	\$52.00
VIRGINIA WAY	\$39.00	WATERWORKS	\$21.97	WHISPER WOOD	\$35.00	WINNING WAYS II	\$15.00	YEN	\$81.97
VIRTUOSO	\$57.97	WATTENBURG	\$74.00	WHISPERING	\$27.97	WINTER BAY	\$24.00	YESTERDAY	\$32.00
VISBY	\$52.00	WAVE BRAID	\$38.00	WHISTLE CALL	\$40.00	WINTERHILL	\$33.97	YIELD	\$54.97
VISIBLY BRIGHT	\$44.00	WAVE GARDEN	\$24.00	WHISTLE STOP	\$57.97	WISCASSET	\$65.97	YING	\$75.97
VISIBLY SOFT	\$40.00	WAVE MAZE	\$58.00	WHITE CHAPEL	\$48.00	WISH	\$54.97	YOLANDA	\$88.97
VISTA	\$116.00	WAVE TONES	\$66.00	WHITE CLIFFS	\$41.97	WISLEY	\$38.00	YOLARA	\$65.97
VISTA DAMASK	\$31.97	WAVES	\$78.00	WHITEBRIDGE	\$46.00	WISPY WOVEN	\$38.00	YORBA LINDA	\$74.97
VISUAL DOTS	\$34.00	WAVING ALONG	\$46.00	WHITewater	\$64.00	WISSOTA	\$65.97	YORKER	\$25.97
VITO	\$65.97	WAVY	\$53.97	WHITSTONE	\$44.97	WISTERIA BLOOM	\$67.97	YOSHIIHITO	\$75.00
VIVACIOUS	\$67.97	WAVY GOODBYE	\$38.00	WIDE EYES	\$58.00	WITHERLEE	\$83.97	YULAN	\$28.00
VIVID STRIPE	\$49.00	WAVY IKAT	\$34.00	WIDE PATH	\$75.00	WONDER GARDEN	\$24.00	YUMIKO	\$29.97
VIVIDLY	\$39.00	WAVY STITCH	\$62.00	WIDE RIBBONS	\$15.95	WOOD COVE	\$28.00	YVES	\$23.97
VIVIENNE	\$94.97	WAVY TRAILS	\$58.00	WIDE STRIPE	\$54.97	WOOD JUNCTION	\$58.00	YVONNE	\$31.97
VOLADORES	\$44.00	WAY OF LIFE	\$32.00	WIDE WAYS	\$40.00	WOODCREST	\$65.97	ZAHARA	\$18.00

WHOLESALE TRADE PRICE LIST
800.333.3777

ROBERT ALLEN accepts MasterCard, Visa® and American Express

ROBERT ALLEN

PATTERN	PRICE
ZAKIM	\$37.97
ZAMBEZI	\$26.00
ZAMBRA	\$34.00
ZANTHURA	\$44.00
ZANY LANES	\$19.00
ZARF	\$52.00
ZARI STRIPE	\$58.00
ZAHA	\$48.00
ZEALOUS	\$87.97
ZEBRA GEO	\$58.00
ZEBRA LINES	\$58.00
ZEBRA SAFARI	\$59.00
ZELDAS LULLABY	\$32.00
ZELLWEGER	\$61.97
ZEN PLAID	\$31.97
ZENO	\$25.00
ZERATI	\$84.00
ZESTY	\$20.00
ZIG ALONG	\$34.00
ZIG ILLUSION	\$48.00
ZIG ZAG BOX	\$62.00
ZIGANA	\$59.97
ZIGGY LINES	\$28.00
ZIGGY POP	\$48.00
ZIGGY ROAD	\$62.00
ZIGGY WAVES	\$48.00
ZIGZAG DIAMOND	\$19.95
ZIGZAG LINES	\$62.00
ZIGZAG ROWS	\$80.00
ZIGZAG STRIPE	\$48.00
ZIGZAG WEAVE	\$28.00
ZILLION	\$91.97
ZINGING ALONG	\$52.00
ZIRCON	\$66.00
ZOGALIS	\$32.00
ZOOM	\$55.00
ZORSE	\$68.00
ZOTZ	\$45.97
ZOU ZOU	\$32.00
ZWIEBACK	\$94.00
ZYANYA	\$54.97

WHOLESALE TRADE PRICE LIST
800.333.3777

ROBERT ALLEN accepts MasterCard, Visa® and American Express

HOW TO CARE FOR FABRICS

The following basic rules of Fabric Care have been compiled by the Decorative Fabric Association. They are only intended as a guide to the Interior Designer. A certain amount of preventative maintenance on the part of the individual homeowner is highly recommended, but the actual cleaning of draperies and upholstery must be performed by a Professional Dry Cleaner who specializes in home furnishings.

1. Fabrics must be protected from the sun.

Draperies should be lined, and also interlined, when fragile fabrics are used. Shades should be drawn during the day, and awnings should be used whenever possible. Window glass magnifies the destructive elements in the rays of the sun. The winter sun and reflection from the snow are even more harmful than the summer sun. Trees and shrubbery help protect windows. Colors can fade by oxidation, "gas fading", if fabrics are kept in storage for too long a period without airing. Some colors are more fugitive than others. Impurities in the air may cause as much fading as the direct rays of the sun.

2. Use a reputable dry cleaner who specializes in home furnishings.

Dust has impurities which affect fabrics. Vacuum fabrics often. Dry cleaning should be done at regular intervals before excessive soil has accumulated. Very few fabrics are washable. Interior Designers should recommend professional dry cleaners to their clients. Clients should not try to remove spots themselves.

3. Be tolerant of normal fluctuations in lengths of draperies.

Few fabrics are completely stable. Fabrics breathe and absorb moisture, resulting in stretching or shrinking. It is reasonable to expect as much as a 3% change in any drapery length. In a 3-yard length (108 inches), this would amount to 3 inches up or down under various conditions. Fabrics placed over or near heating and cooling vents may react to a much greater degree.

4. Fabrics wear out - they are not indestructible.

Wear will vary with the amount of use. Some weaves are stronger than others. A favorite chair will not last as long as a seldom used show piece.

5. Applied finishes may help fabrics resist soil and stain.

Finishes help fabrics resist spotting, but they are not necessarily the end-all to every problem. Light colors are likely to benefit most. Dining room chairs will soil no matter what is used. A finish does not eliminate the necessity of properly caring for fabrics. Spots should be given immediate attention by a professional dry cleaner.

6. Synthetic fibers.

Synthetic yarns have made impressive strides in advancing the technology of weaving, but they cannot perform miracles. Performance will vary with the construction of the fabric and its application.

7. Multiple-width draperies, wallcoverings and bedspreads.

Because fabric, unlike paper, is not a completely stable "substance", it cannot be taken for granted that, whether printed or woven, the pattern will invariably be completely "square" upon the cloth. Although, in printing, every effort is made to avoid distortion, occasionally it will exist. Therefore, when planning multiple-width fabrications, please make certain, before cutting, that pattern alignment is adequate to produce a satisfactory result. This also applies to woven fabrics.

8. In the final analysis, as it is in every industry, the integrity and experience of your supplier is your best assurance as to the integrity value of a fabric, but it must be combined with knowledge and understanding on the part of the consumer.

As compiled by the Decorative Fabrics Association

CLEANABILITY CODE INFORMATION

The following recommended cleaning codes are devised as the results of tests performed by the fabric manufacturers having adhered to the methods requested by the Joint Industry Standards Committee. They in no way intend to imply that we are in any way guaranteeing these fabrics or the cleanability thereof.

CODE S

Dry clean only. Light brushing/vacuuming is recommended.

CODE SW

Dry cleaning is recommended. Spot treat water-based stains with non-chlorinated water-based cleaners/oil-based stains with solvent-based cleaners. Do not launder.

CODE W

Dry cleaning is recommended. Spot treat with non-chlorinated water-based cleaners. Do not launder.

CODE X

Light brushing/vacuuming is recommended. Do not launder. Do not dry clean.

CODE HH

Wash warm (water not to exceed 120°F), tumble dry medium setting, remove promptly, iron as needed, low heat. Do not launder or dry with other products. Do not dry clean. Do not bleach or use softeners.

CODE BL

Clean using 10% bleach solution (10% sodium hypochlorite, 90% water). Condition 5 minutes. Rinse with fresh water.

Any cleaning agent should be tested in an obscure area before proceeding.

SPECIAL FABRIC FINISHES

STAIN REPELLENT

1-30 yards.....\$1.25/yd
 31 yards and over.....\$1.10/yd

Stain repellent can be applied to upholstery fabric, at the time of flame proofing, for an additional charge of \$2.00/yd. All special fabric finish orders must be in full yard increments.

Nano-Tex® + Durablock®

Fabrics finished with Nano-Tex® + Durablock® offer permanent spill and stain resistance with a breathable moisture barrier. Our unique molecular formula imparts permanent performance characteristics designed to attach to each fiber, thus maintaining the original feel of the fabric and never losing breathability.

Fabrics finished with Nano-Tex® offer permanent spill and stain resistance without sacrificing a natural hand.

The Nano-Tex® + Durablock® and Nano-Tex® finishes are available for application to most Robert Allen fabrics. Please note that it is not suitable for application to prints, velvets or delicate fabrics. Please contact Customer Service for further information.

Nano-Tex® + Durablock®

5-9 yards..... \$30.00/yd 20-24 yards..... \$8.00/yd
 10-14 yards..... \$15.00/yd 25-49 yards..... \$6.25/yd
 15-19 yards..... \$10.00/yd 50 yards & over \$5.50/yd

Nano-Tex®

5-19 yards..... Minimum Charge \$150.00
 20-49 yards..... \$4.00/yd
 50 yards & over \$2.75/yd

In addition to the Nano-Tex® + Durablock®, The Robert Allen Group offers a range of finishing options from authorized special finishing agents. All billing for these add-on services will come directly from the authorized agent. The Robert Allen Group will not bill directly for these services.

Please feel free to contact our authorized agent for the following special finishing services
 at **1-888-830-4908** (toll free - exclusively for The Robert Allen Group customers)

FLAMEPROOFING (FR)

Upholstery \$2.50/yd
 Drapery 48" and 54" \$1.75/yd
 Drapery 106" and 118" \$3.50/yd
 Tassel tiebacks & garnishments One price - \$2.50/ea
 Trim: brush, loop & tassel fringe/cording & bouillon One price - \$2.50/yd

To insure that the proper treatment is applied, please provide specific local code requirements. Code requirements may be obtained from the local fire department where fabric will be installed.

BACKING

Acrylic Backing or Flame Retardant Acrylic Backing (Upholstery) \$2.50/yd

Please feel free to contact our authorized agent for the following special finishing services
 at **1-877-379-9332** (toll free - exclusively for The Robert Allen Group customers)

UPHOLSTERY SERVICES

KnitBac™ Fabric Backing – adds stability to any upholstery fabric.

5-30 yards Minimum Charge \$199.95
 31 yards and over \$8.85/yd

Vinylizing or VinylTex™ - the ultimate protection for upholstery fabrics. Visually subtle, enormously effective!

ArmorFlex™ - commercial caliber upholstery protection of your own fabric.

MicroBloc™ - incorporating antimicrobial agents for clean hygienic environments.

TABLE TOP

Custom Laminated - placemats & tablecloths

Please call for quote on any service listed without pricing. All services with customers' own material.

WALL COVERING BACKING

5-31 yards Minimum Charge \$250.00
 32-99 yards \$8.50/yd
 100 yards and over \$7.00/yd

All requests must be pre-approved by RA Tech Services for Wall Covering Application.

KnitBac™, VinylTex™, ArmorFlex™, MicroBloc™ and EradiCote™ are all trademarks of Custom Laminations, Inc.

© 2013 All rights reserved.

ROBERT ALLEN TRIM

PATTERN	PRICE
ABBY.....	\$27.97
ACCORDANCE.....	\$14.97
ADALIA.....	\$93.97
ADELINE.....	\$23.97
AL FRESCO BALL.....	\$71.97
AL FRESCO BEAD.....	\$63.97
AL FRESCO BRAID.....	\$31.97
AL FRESCO BRUSH.....	\$23.97
AL FRESCO CHAIR.....	\$47.97
AL FRESCO LOOP.....	\$33.97
AL FRESCO ROPE.....	\$65.97
AL FRESCO TASSL.....	\$65.97
AL FRESCO TIEBK.....	\$83.97
ALCHEMY BAND.....	\$45.00
ALCHEMY BORDER.....	\$30.00
ALCHEMY BRACELT.....	\$160.00
ALCHEMY BRAID.....	\$48.00
ALCHEMY BRUSH.....	\$24.00
ALCHEMY CHAIR.....	\$104.00
ALCHEMY CORD.....	\$15.00
ALCHEMY CR TBCK.....	\$412.00
ALCHEMY DELUXE.....	\$38.00
ALCHEMY GIMP.....	\$16.00
ALCHEMY JEWELS.....	\$182.00
ALCHEMY JWL TBK.....	\$168.00
ALCHEMY KEY.....	\$58.00
ALCHEMY LEATHER.....	\$20.00
ALCHEMY LUXE.....	\$19.00
ALCHEMY MLT LEA.....	\$20.00
ALCHEMY PEACOCK.....	\$30.00
ALCHEMY POM POM.....	\$78.00
ALCHEMY TASSEL.....	\$58.00
ALCHEMY TWIST.....	\$15.00
ALCHEMY VELVET.....	\$14.00
ALICIA.....	\$87.97
ALLISON.....	\$47.97
ALLIUM.....	\$69.97
ALYSSA.....	\$37.97
AMBOISE.....	\$73.97
ANATASE.....	\$98.97
ANDROMEDA.....	\$93.97
ANTIQUED CORD.....	\$16.00
APADANA.....	\$113.97
AUSTENE.....	\$75.97
AVENZA.....	\$25.97
AYALA.....	\$47.97
AYR.....	\$27.97
AZARIA.....	\$77.97
BALUSTR KEY TSL.....	\$40.00
BALUSTR TIEBACK.....	\$99.00
BAMBOO BRUSH.....	\$26.00
BAMBOO CORD.....	\$19.00
BAMBOO ROUCHE.....	\$28.00
BANDED BRAID.....	\$19.00
BAROQUE BEADS.....	\$62.00
BASHA.....	\$37.97
BEA.....	\$23.97

PATTERN	PRICE
BEAD KEY.....	\$40.00
BEAD TRIM.....	\$94.00
BEADED BUTTON.....	\$34.00
BIANCA.....	\$44.97
BLOIS.....	\$73.97
BOTTICELLI.....	\$321.97
BOULLION ROUGE.....	\$47.97
BRAID.....	\$19.97
BRIA.....	\$31.97
BRIDGET.....	\$48.97
BROLIO.....	\$65.97
BRUSH FRINGE.....	\$40.00
BULLION 4".....	\$61.97
BULLION 8".....	\$93.97
BULLION BRSH FR.....	\$36.00
CALLIGRAPHY BD.....	\$36.00
CANING BRAID.....	\$32.00
CAPRI.....	\$54.97
CASCADING BEADS.....	\$36.00
CASSANDRA.....	\$54.97
CERISSA.....	\$103.97
CHAINLINK BAND.....	\$62.00
CHAIR TIE.....	\$80.00
CHAMBONNEAU.....	\$25.97
CHENONCEAU.....	\$18.00
CHEVRON BAND.....	\$24.00
CHIVERNY.....	\$13.97
CHLOE.....	\$23.97
CIELO.....	\$35.97
CLASSIC BEAD FG.....	\$19.00
CLASSIC BRAID.....	\$16.00
CLASSIC BRUSH.....	\$16.00
CLASSIC CHAIR.....	\$22.00
CLASSIC CORD.....	\$9.00
CLASSIC SCROLL.....	\$16.00
CLASSIC TAPE.....	\$9.00
CLASSIC TIEBACK.....	\$58.00
CLASSIC TSL FRG.....	\$26.00
CLASSIC TWIST.....	\$9.00
COIMBRA.....	\$23.97
COPPELIA.....	\$138.97
CORDED LOOP.....	\$36.00
CRYSTAL BUTTON.....	\$28.00
CUT ROUCHE.....	\$20.00
DALILIA.....	\$93.97
DANIELA.....	\$33.97
DEIRDRA.....	\$97.97
DESIREE.....	\$44.97
DIAMOND BAND.....	\$40.00
DIAMOND CHAIN.....	\$48.00
DIANNA.....	\$31.97
DIAPHANOUS.....	\$61.97
DONOROTICO.....	\$8.97
DORI.....	\$27.97
DOUBLE TIEBACK.....	\$160.00
ELISE.....	\$61.97
EMBELLISHED TSLS.....	\$72.00

PATTERN	PRICE
ETTA.....	\$33.97
FACETTED BD FRG.....	\$94.00
FLEUR BRAID.....	\$38.00
FRINGE BENEFIT.....	\$31.97
FRONZOLA.....	\$27.97
FUR FRINGE.....	\$28.00
FUR TIEBACK.....	\$114.00
GARLAND BRUSH.....	\$38.00
GARLAND GIMP.....	\$15.00
GEMMA.....	\$31.97
GIA.....	\$19.97
GIGI.....	\$93.97
GIZA.....	\$57.97
GREEK KEY BRAID.....	\$34.00
GRESSA.....	\$13.97
GUINEVER.....	\$81.97
HELIONA.....	\$51.97
HERA.....	\$25.97
HOUNDSTOOTH BR.....	\$32.00
IALEMO.....	\$35.97
IALISO.....	\$77.97
IBRIS.....	\$29.97
ICARIO.....	\$161.97
IERA.....	\$47.97
IRISA.....	\$93.97
IRO.....	\$27.97
ISABELLE.....	\$51.97
ISELLE.....	\$41.97
ISSIDE.....	\$31.97
ISTRO.....	\$124.97
ITILO.....	\$87.97
JEWELLED CORD.....	\$48.00
JOSETTE.....	\$51.97
JULIETTE.....	\$51.97
JUTE TAPE.....	\$20.00
KENYA BAND.....	\$32.00
KIRISTA.....	\$147.97
KOUSA.....	\$29.97
KYRIELL.....	\$177.97
LATTICE TASSELS.....	\$40.00
LAUREL.....	\$44.97
LEATHER CORD.....	\$14.00
LEATHER DUO.....	\$53.97
LEATHER TAPE.....	\$16.00
LEITA.....	\$37.97
LIBRARY BASKET.....	\$18.97
LIBRARY BAUBLE.....	\$58.00
LIBRARY BEAD.....	\$70.00
LIBRARY BRAID.....	\$20.00
LIBRARY BRUSH.....	\$19.00
LIBRARY BUL LG.....	\$68.97
LIBRARY BUL SM.....	\$37.97
LIBRARY CHAIR.....	\$37.97
LIBRARY CHECK.....	\$16.00
LIBRARY CORD.....	\$8.00
LIBRARY EYELASH.....	\$28.00
LIBRARY FRINGE.....	\$28.00

ROBERT ALLEN TRIM

PATTERN	PRICE	PATTERN	PRICE	PATTERN	PRICE
LIBRARY GIMP	\$16.00	MULTI TWIST 8"	\$53.97	SOIREE	\$77.97
LIBRARY KEY	\$29.97	MYCENAE	\$23.97	SOLID BAND	\$9.00
LIBRARY LOOP	\$30.00	NARA	\$35.97	SOLID CORD	\$13.97
LIBRARY MODERN	\$41.97	NOREEN	\$44.97	SOLID LIP CORD	\$13.97
LIBRARY PLEAT	\$28.00	OLGA	\$23.97	SOLMAR	\$51.97
LIBRARY R BL L	\$70.00	OLGA-CUSTOM	\$13.97	SONIA	\$51.97
LIBRARY R BL S	\$40.00	OLIVETO	\$15.97	SPECTR BRAID	\$22.00
LIBRARY R CHAIR	\$40.00	ON THE EDGE	\$25.97	SPECTR BRUSH FR	\$18.00
LIBRARY R KEY	\$36.00	OUTSKIRTS	\$51.97	SPECTR CHAIR T	\$58.00
LIBRARY R TIEBK	\$99.00	PAISLEY TAPE	\$19.00	SPECTR CORD LIP	\$8.00
LIBRARY RIBBON	\$19.00	PANDORA	\$37.97	SPECTR GIMP	\$9.00
LIBRARY ROPE	\$10.00	PANZANO	\$8.97	SPECTR KEY TSL	\$30.00
LIBRARY ROUCHE	\$22.00	PARISIAN BD RST	\$10.00	SPECTR MINI CRD	\$6.00
LIBRARY RUFFLE	\$73.97	PARISIAN CHAIR	\$16.00	SPECTR RIB CORD	\$10.00
LIBRARY STRIPE	\$18.00	PARISIAN KEY	\$30.00	SPECTR ROUCH LP	\$16.00
LIBRARY TAPE	\$36.00	PARISIAN TBCK	\$78.00	SPECTR TASSL FR	\$40.00
LIBRARY TASSEL	\$55.00	PATENT CORD	\$14.00	SPECTR TIEBACK	\$62.00
LIBRARY TIEBACK	\$89.97	PETITE CORD	\$10.00	STEPHANA	\$31.97
LIBRARY TWEED	\$19.00	PETITE ROPE CRD	\$16.00	STRIE BRAID	\$36.00
LILY	\$77.97	PICOT GIMP	\$10.00	STRIPED TAPE	\$15.00
LINARDI	\$17.97	PLEATED BAND	\$30.00	SUDAN BAND	\$36.00
LINARIA	\$157.97	PYTHON CORD	\$14.00	SUEDE CORD	\$14.00
LINEN DART BAND	\$30.00	RACHELLE	\$37.97	SUEDE TAPE	\$15.00
LIP TWIST	\$19.00	RAFFIA BRAID	\$26.00	SUMERIA	\$51.97
LOOP BRAID	\$40.00	RANCHERO	\$38.97	SVETLANA	\$94.97
LOOP FRINGE	\$40.00	RAPUNZEL	\$133.97	TASHA	\$61.97
LORALEE	\$23.97	REGAL LOOPS	\$22.00	TASSEL FRINGE	\$53.97
LUCARDO	\$51.97	REIMS	\$44.97	TASSEL TIE	\$73.97
LUNA	\$19.97	RIBBED BUTTON	\$16.00	TESSA	\$27.97
LUTEA	\$27.97	RIBBON LOOP	\$25.00	TEXTURED TAPE	\$19.00
LUYNES	\$71.97	RICRAC PLEAT	\$26.00	TIA	\$14.97
LYDIA	\$19.97	RIVERST MINI KY	\$16.00	TOGO BAND	\$34.00
LYSANDRA	\$157.97	RIVERSTN BEADS	\$40.00	TRAD BEAD FRING	\$36.00
MADLINE	\$88.97	RIVERSTN CHRTIE	\$48.00	TRAD BRAID	\$16.00
MALAWI BAND	\$32.00	RIVERSTN KEY TS	\$28.00	TRAD BRUSH	\$19.00
MALI BAND	\$40.00	RUFFLED ROUCHE	\$18.00	TRAD BULLION	\$38.00
MAR	\$37.97	RUSTICA BALL	\$55.00	TRAD CHAIR TIE	\$28.00
MARCELLE	\$27.97	RUSTICA BRUSH	\$42.00	TRAD CORD	\$9.00
MAYBELLINE	\$97.97	RUSTICA BULLION	\$40.00	TRAD KEY TASSEL	\$16.00
MELA	\$15.97	RUSTICA CHAIR	\$55.00	TRAD MINI CORD	\$6.00
MELEE	\$73.97	RUSTICA CORD	\$15.00	TRAD TAPE	\$9.00
MIES	\$25.97	RUSTICA FLMSTCH	\$32.00	TRAD TASSEL FRG	\$28.00
MIGNON	\$235.97	RUSTICA GIMP	\$15.00	TRAD TIEBACK	\$40.00
MIMI	\$115.97	RUSTICA GRILLE	\$26.00	TRELLIS TASSELS	\$36.00
MINI BEAD FRING	\$62.00	RUSTICA KEY	\$30.00	TRESSA	\$47.97
MINI LIP TWIST	\$19.00	RUSTICA LATTICE	\$26.00	TRILLION	\$27.97
MINI TASSELS	\$51.97	RUSTICA PLEAT	\$36.00	TRINITA	\$38.97
MINI TWIST	\$19.97	RUSTICA ROPE	\$20.00	TWIST	\$23.97
MITZI	\$44.97	RUSTICA ROUCHE	\$30.00	TWO TASSEL	\$37.97
MODERN BEAD	\$22.00	RUSTICA SASH	\$94.00	VALENCAY	\$38.97
MONTANA	\$51.97	RUSTICA TASSEL	\$72.00	VELOUR GIMP	\$26.00
MONTRICHARD	\$115.97	RUSTICA TIEBACK	\$66.00	VELOUR SCROLL	\$24.00
MORA	\$31.97	SASHIELL	\$171.97	VELVET BRAID	\$26.00
MULTI BRUSH	\$29.97	SCALLOP TRIM	\$58.00	VELVET TAPE	\$19.00
MULTI CORD	\$15.97	SCROLL BRAID	\$52.00	VELVET TASSEL	\$78.00
MULTI LIP CORD	\$18.97	SHELL TAPE	\$30.00	VELVET TRIM	\$87.97
MULTI TWIST 4"	\$31.97	SINGLE SWEEP	\$25.97	VENEZIA BRAID	\$37.97

ROBERT ALLEN TRIM

PATTERN	PRICE
VENEZIA BULLION	\$79.97
VENEZIA CHAIR	\$48.97
VENEZIA CORDLG	\$16.00
VENEZIA CORDSM	\$11.97
VENEZIA EYELSH	\$21.97
VENEZIA FRINGE.....	\$30.00
VENEZIA KEY	\$27.97
VENEZIA ROPE	\$61.97
VENEZIA ROUCHE.....	\$33.97
VENEZIA TASSEL.....	\$65.97
VENEZIA TIEBCK	\$98.97
VERONIQUE	\$69.97
VILLA BAND.....	\$63.97
VILLA BRAID	\$25.97
VILLA BRUSH	\$27.97
VILLA CHAIRTIE	\$31.97
VILLA CORD	\$23.97
VILLA FRINGE	\$48.97
VILLA KEY.....	\$47.97
VILLA LIP.....	\$23.97
VILLA MINI CORD.....	\$19.97
VILLA MINI LIP	\$22.00
VILLA ROSETTE.....	\$31.97
VILLA TAPE.....	\$23.97
VILLA TASSELS	\$48.97
VILLA TIEBACK.....	\$163.97
VILLA TRIM	\$75.97
VINE BRAID	\$42.00
VINTAGE BORDER.....	\$37.97
VINTAGE FEATHER	\$37.97
VINTAGE LIPCORD.....	\$14.97
VINTAGE TIEBACK.....	\$107.97
VIVIENNE.....	\$94.97
WAVE BRAID	\$38.00
WOVEN BAND.....	\$44.97
WOVEN CORD	\$48.97
YVES.....	\$23.97
YVONNE	\$31.97

ROBERT ALLEN DRAPERY HARDWARE

AL FRESCO COLLECTION

Description	Finishes	Wholesale	
FINIALS		1" - PAIR	1.5" - PAIR
Coral.....	Coral.....	\$124.00.....	\$124.00
Hammered Ball.....	Black, Bronze, Pewter, Silver.....	\$46.00.....	\$84.00
Lantern.....	Black, Bronze, Pewter, Silver.....		\$118.00
Palm Leaf.....	Black, Bronze, Pewter, Silver.....	\$78.00.....	\$78.00
Pinecone.....	Black, Bronze, Pewter, Silver.....	\$46.00.....	\$84.00
STANDARD RODS (Available in 4' & 8' lengths)		4' - EACH	8' - EACH
1" Standard Rod.....	Black, Bronze, Coral, Pewter, Silver.....	\$46.00.....	\$84.00
1.5" Standard Rod.....	Black, Bronze, Coral, Pewter, Silver.....	\$58.00.....	\$104.00
TRAVERSE RODS (Available in 4' & 8' lengths)		4' - EACH	8' - EACH
1" Traverse Rod.....	Black, Bronze, Coral, Pewter, Silver.....	\$104.00.....	\$168.00
1.5" Traverse Rod.....	Black, Bronze, Coral, Pewter, Silver.....	\$118.00.....	\$202.00
1" One-Way Draw System.....	Black, Bronze, Coral, Pewter, Silver.....	\$34.00.....	\$54.00
1.5" One-Way Draw System.....	Black, Bronze, Coral, Pewter, Silver.....	\$36.00.....	\$59.00
BRACKETS		1" - EACH	1.5" - EACH
Standard Bracket.....	Black, Bronze, Coral, Pewter, Silver.....	\$10.00.....	\$12.00
Traverse Bracket.....	Black, Bronze, Coral, Pewter, Silver.....	\$26.00.....	\$32.00
TIEBACKS		PAIR	
Ball Tieback.....	Black, Bronze, Coral, Pewter, Silver.....	\$65.00	
OTHER		EACH	
1" Standard Rod Connector.....	N/A.....	\$12.00	
1.5" Standard Rod Connector.....	N/A.....	\$12.00	
1" Traverse Rod Connector.....	N/A.....	\$22.00	
1.5" Traverse Rod Connector.....	N/A.....	\$22.00	
1" End Cap.....	Black, Bronze, Coral, Pewter, Silver.....	\$14.00	
1.5" End Cap.....	Black, Bronze, Coral, Pewter, Silver.....	\$16.00	
Wand.....	Black, Bronze, Coral, Pewter, Silver.....	\$46.00	
		PACKAGE	
Drapery Hooks.....	N/A.....	(10 pcs).....	\$8.00
Glides.....	Black.....	(10 Glides).....	\$19.00
1.5" Ring.....	Black, Bronze, Coral, Pewter, Silver.....	(10 Rings).....	\$36.00
2" Ring.....	Black, Bronze, Coral, Pewter, Silver.....	(10 Rings).....	\$42.00

- 1" brackets have a 3.5" projection. 1.5" brackets have a 3.75" projection.
- Brackets are sold separately for standard and traverse rods. 2 brackets are recommended for 4ft rods, 3 brackets are recommended for 8ft rods.

PREMIUM TRAVERSE SYSTEM FEATURES

- Hand-draw traverse rods are available in 1" & 1.5" diameters, and 4' & 8' lengths. Reversible one-way draw traverse options available.
- Hand-draw traverse adds the utility of full drapery movement across the entire rod due to specially-designed top-mount brackets.
- 1" and 1.5" rods include rust-proof roller glides for smooth and easy movement of draperies.
- One-way hand-draw traverse rod system includes 16 glides for 4' rods and 32 glides for 8' rods, one master carrier with arm and 2 end stops.
- One-way draw features reversible master carrier arm so that draw can either be from the left side or the right side.
- The use of a wand is strongly recommended for traverse rods.
- Use a splice to connect two traverse rods together.

Standard drapery rods are considered to be decorative drapery hardware, while traverse rod options provide both decorative and functional capabilities. While standard drapery rods are also functional, some collections are more appropriate for stationary treatments than others. This collection was designed to be special and unique for the designer to achieve a truly beautiful design statement, yet functional when the traverse rod option is selected. Standard drapery rods may be less appropriate for windows that require day-to-day functionality. Please contact Robert Allen Customer Service for further information.

**ROBERT ALLEN DRAPERY HARDWARE
ARCHITRAVE COLLECTION**

Description	Finishes	Wholesale	
		1" - PAIR	1.5" - PAIR
FINIALS			
Axis.....	Antique, Antique Gold, Earth Rust, Watermark Silver	\$132.00	
Caliz.....	Antique, Antique Gold, Earth Rust, Watermark Silver	\$114.00	
Pino	Antique, Antique Gold, Earth Rust, Watermark Silver	\$75.00	
Pomegranate.....	Antique, Antique Gold, Earth Rust, Watermark Silver	\$75.00	
Quatrefoil.....	Antique, Antique Gold, Earth Rust, Watermark Silver	\$102.00	
Turban	Antique, Antique Gold, Earth Rust, Watermark Silver	\$89.00	
Vase.....	Antique, Antique Gold, Earth Rust, Watermark Silver	\$144.00	
STANDARD RODS (Available in 4' & 8' lengths)		4' - EACH	8' - EACH
1" Standard Rod (with Liner)	Antique, Antique Gold, Earth Rust, Watermark Silver	\$48.00	\$92.00
1.5" Standard Rod (with Liner)	Antique, Antique Gold, Earth Rust, Watermark Silver	\$49.00	\$94.00
TRAVERSE RODS (Available in 4' & 8' lengths)		4' - EACH	8' - EACH
1" Traverse Rod.....	Antique, Antique Gold, Earth Rust, Watermark Silver	\$124.00	\$184.00
1.5" Traverse Rod.....	Antique, Antique Gold, Earth Rust, Watermark Silver	\$140.00	\$226.00
1" Center Draw System	Antique, Antique Gold, Earth Rust, Watermark Silver	\$62.00	\$72.00
1.5" Center Draw System	Antique, Antique Gold, Earth Rust, Watermark Silver	\$84.00	\$122.00
1" One-Way Draw System.....	Antique, Antique Gold, Earth Rust, Watermark Silver	\$34.00	\$54.00
1.5" One-Way Draw System.....	Antique, Antique Gold, Earth Rust, Watermark Silver	\$60.00	\$100.00
BRACKETS		1" - EACH	1.5" - EACH
Standard Bracket.....	Antique, Antique Gold, Earth Rust, Watermark Silver	\$8.00	\$12.00
Extended Bracket.....	Antique, Antique Gold, Earth Rust, Watermark Silver	\$10.00	\$14.00
Traverse Bracket	Antique, Antique Gold, Earth Rust, Watermark Silver	\$26.00	\$32.00
Inside Mount.....	Antique, Antique Gold, Earth Rust, Watermark Silver	\$16.00	\$24.00
TIEBACKS			PAIR
Floral.....	Antique, Antique Gold, Earth Rust, Watermark Silver	\$58.00	
Radius	Antique, Antique Gold, Earth Rust, Watermark Silver	\$58.00	
Short Post - Male Tieback	Antique, Antique Gold, Earth Rust, Watermark Silver	\$12.00	
Short Post - Female Tieback	Antique, Antique Gold, Earth Rust, Watermark Silver	\$12.00	
ROSETTES			EACH
Floral	Antique, Antique Gold, Earth Rust, Watermark Silver	\$10.00	
Radius	Antique, Antique Gold, Earth Rust, Watermark Silver	\$10.00	
OTHER		1" - EACH	1.5" - EACH
Traverse Rod Connector	N/A.....	\$18.00	\$18.00
Corner Angle Connector	Antique, Antique Gold, Earth Rust, Watermark Silver	\$38.00	\$44.00
End Cap.....	Antique, Antique Gold, Earth Rust, Watermark Silver	\$12.00	\$18.00

ROBERT ALLEN DRAPERY HARDWARE
ARCHITRAVE COLLECTION *continued*

Description	Finishes	Wholesale
PACKAGE		
1.5" Ring.....	Antique, Antique Gold, Earth Rust, Watermark Silver	(10 Rings).....\$35.00
2" Ring.....	Antique, Antique Gold, Earth Rust, Watermark Silver	(10 Rings).....\$39.00
1" Traverse Rod Glides	N/A.....	(10 Glides).....\$6.00
1.5" Traverse Rod Glides	N/A.....	(10 Glides).....\$19.00
EACH		
Wand	Antique, Antique Gold, Earth Rust, Watermark Silver	\$46.00

- 1" brackets have a 3.5" projection. 1.5" brackets have a 3.75" projection.
- Brackets are sold separately for standard and traverse rods. 2 brackets are recommended for 4ft rods, 3 brackets are recommended for 8ft rods.

PREMIUM TRAVERSE SYSTEM FEATURES

- Hand-draw traverse rods available in 1" & 1.5" diameters, and 4' & 8' lengths. One-way draw and center draw traverse options available.
- Hand-draw traverse adds the utility of full drapery movement across the entire rod due to specially-designed top-mount brackets.
- 1" rod includes nylon glides; 1.5" rod includes roller glides with ball bearings.
- 1" traverse rod cannot be used with finials. Can only be utilized with end caps, inside mounts, or as a secondary rod in conjunction with the double bracket.
- One-way hand-draw traverse rod system includes 16 glides for 4' rods and 32 glides for 8' rods, one master carrier with arm and 2 end stops.
- One-way draw features reversible master carrier arm so draw can either be from the left side or the right side.
- Center draw traverse rod system includes 16 glides for 4' rods and 32 glides for 8' rods, pair of master carriers with overlap arm and standard arm, and 2 end stops. The master carrier arms (standard and overlap) are reversible that so that the overlap can be left over right or right over left.
- The use of a wand is strongly recommended for traverse rods.
- Use a splice to connect two traverse rods together.

Standard drapery rods are considered to be decorative drapery hardware, while traverse rod options provide both decorative and functional capabilities. While standard drapery rods are also functional, some collections are more appropriate for stationary treatments than others. This collection was designed to be special and unique for the designer to achieve a truly beautiful design statement, yet functional when the traverse rod option is selected. Standard drapery rods may be less appropriate for windows that require day-to-day functionality. Please contact Robert Allen Customer Service for further information.

ROBERT ALLEN DRAPERY HARDWARE BEDPOST COLLECTION

Description	Finishes	Wholesale	
FINIALS		PAIR	
Bulb	Cherry, Country White, Mahogany, Pine, Walnut	\$82.00	
Globe	Cherry, Country White, Mahogany, Pine, Walnut	\$112.00	
Knob	Cherry, Country White, Mahogany, Pine, Walnut	\$92.00	
Pinecone Small.....	Cherry, Country White, Mahogany, Pine, Walnut	\$138.00	
Pinecone Large	Cherry, Country White, Mahogany, Pine, Walnut	\$142.00	
Top.....	Cherry, Country White, Mahogany, Pine, Walnut	\$89.00	
Urn.....	Cherry, Country White, Mahogany, Pine, Walnut	\$74.00	
RODS (Available in 4' & 8' lengths)		4' - EACH	8' - EACH
1.25" Plain Rod.....	Cherry, Country White, Mahogany, Pine, Walnut	\$70.00	\$105.00
1.75" Plain Rod.....	Cherry, Country White, Mahogany, Pine, Walnut	\$78.00	\$112.00
1.25" Twirl Rod	Cherry, Country White, Mahogany, Pine, Walnut	\$116.00	\$189.00
1.75" Twirl Rod	Cherry, Country White, Mahogany, Pine, Walnut	\$126.00	\$232.00
BRACKETS		1.25"- EACH	1.75"- EACH
Standard Bracket.....	Cherry, Country White, Mahogany, Pine, Walnut	\$24.00	\$24.00
Decorative Bracket	Cherry, Country White, Mahogany, Pine, Walnut	\$55.00	\$55.00
Extended Bracket	Cherry, Country White, Mahogany, Pine, Walnut	\$28.00	\$28.00
Inside Mount.....	Cherry, Country White, Mahogany, Pine, Walnut	\$32.00	\$34.00
TIEBACKS		PAIR	
Button	Cherry, Country White, Mahogany, Pine, Walnut	\$108.00	
OTHER		1.25"- EACH	1.75"- EACH
End Cap.....	Cherry, Country White, Mahogany, Pine, Walnut	\$25.00	\$26.00
		PACKAGE	
1.75" Rings for 1.25" Rods	Cherry, Country White, Mahogany, Pine, Walnut	(10 Rings)	\$58.00
2.25" Rings for 1.75" Rods	Cherry, Country White, Mahogany, Pine, Walnut	(10 Rings)	\$62.00

- Standard brackets have a 3.5" projection. Extended brackets have a 5.5" projection. Decorative bracket may be cut for extension between 4" and 9.25".
- Brackets are sold separately. 2 brackets are recommended for 4ft rods, 3 brackets are recommended for 8ft rods.

Standard drapery rods are considered to be decorative drapery hardware. While standard drapery rods are also functional, some collections are more appropriate for stationary treatments than others. Standard drapery rods may be less appropriate for windows that require day-to-day functionality. Please contact Robert Allen Customer Service for further information.

**ROBERT ALLEN DRAPERY HARDWARE
CASUAL ELEGANCE COLLECTION**

Description	Finishes	Wholesale		
FINIALS		1.5" - PAIR	2.25" - PAIR	
Artichoke.....	Antique Iron, Golden Patina, Silver Patina, Walnut.....	\$42.00.....	\$64.00	
Ball.....	Antique Iron, Golden Patina, Silver Patina, Walnut.....	\$42.00.....	\$64.00	
Crystal Ball.....	Golden Patina, Silver Patina.....	\$84.00.....	\$112.00	
Crystal Knob.....	Golden Patina, Silver Patina.....	\$80.00.....	\$158.00	
Medallion Knob.....	Antique Iron, Golden Patina, Silver Patina, Walnut.....	\$42.00.....	\$64.00	
Mirrored Glass.....	Golden Patina, Silver Patina.....	\$84.00.....	\$112.00	
Ring Finial.....	Antique Iron, Golden Patina, Silver Patina, Walnut.....	\$42.00.....	\$64.00	
STANDARD RODS (Available in 4', 6' & 8' lengths)		4' - EACH	6' - EACH	8' - EACH
1.5" Standard Rod.....	Antique Iron, Golden Patina, Silver Patina, Walnut.....	\$54.00.....	\$80.00.....	\$104.00
2.25" Standard Rod.....	Antique Iron, Golden Patina, Silver Patina, Walnut.....	\$116.00.....	\$164.00.....	\$209.00
.75" Secondary Rod.....	Antique Iron, Golden Patina, Silver Patina, Walnut.....	\$28.00.....	\$35.00.....	\$42.00
TRAVERSE RODS (Available in 4', 6' & 8' lengths)		4' - EACH	6' - EACH	8' - EACH
2.25" Traverse Rod.....	Antique Iron, Golden Patina, Silver Patina, Walnut.....	\$48.00.....	\$88.00.....	\$116.00
2.25" Single Track Hand-Draw System.....	Brown.....	\$39.00.....	\$56.00.....	\$68.00
2.25" Single Track Corded System.....	Brown.....	\$92.00.....	\$112.00.....	\$134.00
2.25" Single Track Hand-Draw C-Ring System.....	Brown.....	\$39.00.....	\$49.00.....	\$56.00
2.25" Single Track Corded C-Ring System.....	Brown.....	\$84.00.....	\$94.00.....	\$102.00
2.25" Double Track Hand-Draw System.....	Brown.....	\$78.00.....	\$112.00.....	\$136.00
2.25" Double Track Corded System.....	Brown.....	\$184.00.....	\$224.00.....	\$268.00
2.25" Double Track Hand-Draw C-Ring System.....	Brown.....	\$78.00.....	\$98.00.....	\$112.00
2.25" Double Track Corded C-Ring System.....	Brown.....	\$168.00.....	\$188.00.....	\$204.00
BRACKETS		.75" - EACH	1.5" - EACH	2.25" - EACH
Standard Bracket.....	Antique Iron, Golden Patina, Silver Patina, Walnut.....	\$22.00.....	\$28.00	
Double Bracket.....	Antique Iron, Golden Patina, Silver Patina, Walnut.....	\$28.00.....	\$32.00	
Traverse Bracket.....	Brown.....	\$14.00		
Double Traverse Bracket.....	Brown.....	\$16.00		
Inside Mount.....	Antique Iron, Golden Patina, Silver Patina, Walnut.....	\$12.00.....	\$16.00.....	\$16.00
TIEBACKS		PAIR		
Holdback.....	Antique Iron, Golden Patina, Silver Patina, Walnut.....	\$32.00		
RINGS		PACKAGE		
1.5" Standard Rings.....	Antique Iron, Golden Patina, Silver Patina, Walnut.....	(10 Rings).....		\$38.00
2.25" Standard Rings.....	Antique Iron, Golden Patina, Silver Patina, Walnut.....	(10 Rings).....		\$52.00
.75" Secondary Rod Rings.....	Antique Iron, Golden Patina, Silver Patina, Walnut.....	(10 Rings).....		\$32.00
2.25" Traverse Rod C-Rings.....	Antique Iron, Golden Patina, Silver Patina, Walnut.....	(8 Rings).....		\$34.00

ROBERT ALLEN DRAPERY HARDWARE
CASUAL ELEGANCE COLLECTION *continued*

Description	Finishes	Wholesale		
OTHER		.75"- EACH	1.5"- EACH	2.25"- EACH
End Cap.....	Antique Iron, Golden Patina, Silver Patina, Walnut	\$12.00	\$12.00	\$12.00
Elbow Connector	Antique Iron, Golden Patina, Silver Patina, Walnut	\$38.00	\$42.00	\$50.00
				PAIR
.75" Secondary Rod End Cap	Antique Iron, Golden Patina, Silver Patina, Walnut			\$12.00
				EACH
Traverse Rod Connector	Antique Iron, Golden Patina, Silver Patina, Walnut			\$12.00
Wand	Antique Iron, Golden Patina, Silver Patina, Walnut.....			\$38.00

- 1.5" standard brackets have a 4" projection. 2.25" brackets have a 4.25" projection. 1.5" standard double brackets have a 5" projection for the front rod and a 2.5" projection for the back rod. 2.25" standard double brackets have a 5.5" projection for the front rod and a 2.5" for the back rod.
- Brackets are sold separately. 2 standard brackets are recommended for 4ft and 6ft rods, 3 standard brackets are recommended for 8ft rods.

PREMIUM TRAVERSE SYSTEM FEATURES

- Premium, single and double track, center-draw traverse rod systems are available in 4', 6' and 8' lengths.
- Heavy-duty aluminum tracks are of the highest quality.
- Superior strength performance. Maximum fabric weight: 6 pounds per foot.
- Tracks are powder-coated inside and out in a brown finish, and sealed with a factory-applied dry-lubricant. This patented finishing technique allows for smooth operation and effortless glide of drapery across the rod.
- Premium hand-draw traverse system includes aluminum track(s), Klick glides (14 with 4', 22 with 6' and 28 with 8'), left and right master carriers, and end stops.
- Premium corded traverse system includes aluminum track(s), Klick glides (14 with 4', 22 with 6' and 28 with 8'), left and right master carriers, right-side cord control with 6' cord drop, mounted cord pulley, and end stops.
- C-ring system includes same as other traverse systems except track is threaded with c-ring glides and master carriers.
- 2.25" Wood Traverse Rods, C-rings, Wands, and Brackets are sold separately.
- Single track brackets are 3" long with a 2.5" projection. The double track brackets are 6" long with 5.5" projection for the front track and 1.75" projection for the back track.
- 3 traverse brackets are recommended for 4ft and 6ft rods, 4 traverse brackets are recommended for 8ft rods.

Standard drapery rods are considered to be decorative drapery hardware, while traverse rod options provide both decorative and functional capabilities. While standard drapery rods are also functional, some collections are more appropriate for stationary treatments than others. This collection was designed to be special and unique for the designer to achieve a truly beautiful design statement, yet functional when the traverse rod option is selected. Standard drapery rods may be less appropriate for windows that require day-to-day functionality. Please contact Robert Allen Customer Service for further information.

ROBERT ALLEN DRAPERY HARDWARE CHESS COLLECTION

Description	Finishes	Wholesale		
FINIALS		PAIR		
Castle	Driftwood, Mahogany	\$122.00		
Castle	Old World Gold, Watermark Silver	\$138.00		
King	Driftwood, Mahogany	\$122.00		
King	Old World Gold, Watermark Silver	\$138.00		
Knight	Driftwood, Mahogany	\$122.00		
Knight	Old World Gold, Watermark Silver	\$138.00		
Queen.....	Driftwood, Mahogany	\$122.00		
Queen.....	Old World Gold, Watermark Silver	\$138.00		
Rook	Driftwood, Mahogany	\$122.00		
Rook	Old World Gold, Watermark Silver	\$138.00		
TIEBACKS		PAIR		
King Holdback	Driftwood, Mahogany, Old World Gold, Watermark Silver	\$95.00		
STANDARD RODS (Available in 4', 6' & 8' lengths)		4' - EACH	6' - EACH	8' - EACH
2.25" Standard Rod	Driftwood, Mahogany	\$79.00	\$116.00	\$158.00
2.25" Standard Rod	Old World Gold, Watermark Silver	\$95.00	\$138.00	\$189.00
1.125" Secondary Rod	Antique Gold	\$28.00	\$42.00	\$55.00
TRAVERSE RODS (Available in 4', 6' & 8' lengths)		4' - EACH	6' - EACH	8' - EACH
2.25" Traverse Rod	Driftwood, Mahogany	\$54.00	\$76.00	\$105.00
2.25" Traverse Rod	Old World Gold, Watermark Silver	\$64.00	\$94.00	\$126.00
2.25" Single Track Hand-Draw System	Brown	\$39.00	\$56.00	\$68.00
2.25" Single Track Corded System.....	Brown	\$92.00	\$112.00	\$134.00
2.25" Single Track Hand-Draw C-Ring System	Brown	\$39.00	\$49.00	\$56.00
2.25" Single Track Corded C-Ring System	Brown	\$84.00	\$94.00	\$102.00
2.25" Double Track Hand-Draw System.....	Brown	\$78.00	\$112.00	\$136.00
2.25" Double Track Corded System	Brown	\$184.00	\$224.00	\$268.00
2.25" Double Track Hand-Draw C-Ring System.....	Brown	\$78.00	\$98.00	\$112.00
2.25" Double Track Corded C-Ring System	Brown	\$168.00	\$188.00	\$204.00
BRACKETS		EACH		
Adjustable Bracket.....	Driftwood, Mahogany	\$46.00		
Adjustable Bracket.....	Old World Gold, Watermark Silver	\$54.00		
Adjustable Traverse Bracket.....	Driftwood, Mahogany	\$46.00		
Adjustable Traverse Bracket.....	Old World Gold, Watermark Silver	\$54.00		
Secondary Rod Bracket.....	Antique Gold	\$19.00		
Standard Traverse Bracket.....	Brown	\$14.00		
Double Traverse Bracket.....	Brown	\$16.00		
RINGS		PACKAGE		
2.25" Standard Rings	Driftwood, Mahogany	(10 Rings)	\$55.00	
2.25" Standard Rings	Old World Gold, Watermark Silver	(10 Rings)	\$64.00	
1.125" Secondary Rod Rings	Antique Gold	(7 Rings)	\$14.00	
2.75" C-Rings	Driftwood, Mahogany	(8 Rings)	\$38.00	
2.75" C-Rings	Old World Gold, Watermark Silver	(8 Rings)	\$42.00	

ROBERT ALLEN DRAPERY HARDWARE
CHESSE COLLECTION *continued*

Description	Finishes	Wholesale
OTHER		EACH
40"L Wand	Driftwood, Mahogany, Old World Gold, Watermark Silver	\$42.00
Elbow Connector	Driftwood, Mahogany	\$38.00
Elbow Connector	Old World Gold, Watermark Silver	\$40.00
1.875" Pawn End Cap	Driftwood, Mahogany, Old World Gold, Watermark Silver	\$24.00
		PAIR
1" Secondary Rod End Cap	Antique Gold	\$22.00

- Adjustable brackets have a 10.5" projection. Secondary Rod brackets have a 3.5" projection.
- Brackets are sold separately.

PREMIUM TRAVERSE SYSTEM FEATURES

- Premium, single and double track, center-draw traverse rod systems are available in 4', 6' and 8' lengths.
- Heavy-duty aluminum tracks are of the highest quality.
- Superior strength performance. Maximum fabric weight: 6 pounds per foot.
- Tracks are powder-coated inside and out in a brown finish, and sealed with a factory-applied dry-lubricant. This patented finishing technique allows for smooth operation and effortless glide of drapery across the rod.
- Premium hand-draw traverse system includes aluminum track(s), Klick glides (14 with 4', 22 with 6' and 28 with 8'), left and right master carriers, and end stops.
- Premium corded traverse system includes aluminum track(s), Klick glides (14 with 4', 22 with 6' and 28 with 8'), left and right master carriers, right side cord control with 6' cord drop, mounted cord pulley, and end stops.
- C-ring system includes same as other traverse systems except track is threaded with c-ring glides and master carriers.
- 2.25" Wood Traverse Rods, C-rings, Wands, and Brackets are sold separately.
- Single track brackets are 3" long with a 2.5" projection. The double track brackets are 6" long with 5.5" projection for the front track and 1.75" projection for the back track.
- 3 traverse brackets are recommended for 4ft and 6ft rods, 4 traverse brackets are recommended for 8ft rods.
- Adjustable Traverse Bracket is sold separately and is meant for decorative purposes only. The bracket projects 10.5" and can be cut down to preferred length.
- Brackets are sold separately for standard and traverse rods.

Standard drapery rods are considered to be decorative drapery hardware, while traverse rod options provide both decorative and functional capabilities. While standard drapery rods are also functional, some collections are more appropriate for stationary treatments than others. This collection was designed to be special and unique for the designer to achieve a truly beautiful design statement, yet functional when the traverse rod option is selected. Standard drapery rods may be less appropriate for windows that require day-to-day functionality. Please contact Robert Allen Customer Service for further information.

**ROBERT ALLEN DRAPERY HARDWARE
CLASSIC COLLECTION**

Description	Finishes	Wholesale		
FINIALS		PAIR		
Chester	Antique Walnut, Distressed Oak, Mahogany, Maple	\$74.00		
Dunlap	Antique Walnut, Distressed Oak, Mahogany, Maple	\$84.00		
Federal	Antique Walnut, Distressed Oak, Mahogany, Maple	\$102.00		
Newport	Antique Walnut, Distressed Oak, Mahogany, Maple	\$80.00		
Pembroke	Antique Walnut, Distressed Oak, Mahogany, Maple	\$74.00		
STANDARD RODS (Available in 4', 6' & 8' lengths)		4' - EACH	6' - EACH	8' - EACH
1.75" Standard Rod	Antique Walnut, Distressed Oak, Mahogany, Maple	\$76.00	\$112.00	\$146.00
BRACKETS		EACH		
Standard Bracket	Antique Walnut, Distressed Oak, Mahogany, Maple	\$32.00		
Extended Bracket	Antique Walnut, Distressed Oak, Mahogany, Maple	\$38.00		
OTHER		PAIR		
1.75" End Cap	Antique Walnut, Distressed Oak, Mahogany, Maple	\$42.00		
		PACKAGE		
1.75" Ring	Antique Walnut, Distressed Oak, Mahogany, Maple	(10 Rings) \$52.00		
		EACH		
40" L Wand	Antique Walnut, Distressed Oak, Mahogany, Maple	\$42.00		

• Brackets are sold separately. 2 brackets are recommended for 4ft and 6ft rods, 3 brackets are recommended for 8ft rods.

Standard drapery rods are considered to be decorative drapery hardware. While standard drapery rods are also functional, some collections are more appropriate for stationary treatments than others. Standard drapery rods may be less appropriate for windows that require day-to-day functionality. Please contact Robert Allen Customer Service for further information.

**ROBERT ALLEN DRAPERY HARDWARE
COSTUME COLLECTION**

Description	Finishes	Wholesale	
FINIALS		PAIR	
Ball	Burnished Gold, Burnished Silver.....	\$139.00	
Basketweave	Burnished Gold, Burnished Silver.....	\$142.00	
Crystal	Burnished Gold, Burnished Silver.....	\$238.00	
Hatpin	Boudoir	\$155.00	
Hatpin	Burnished Gold, Burnished Silver.....	\$158.00	
Marble Egg	Burnished Gold.....	\$155.00	
Oval	Burnished Gold, Burnished Silver.....	\$158.00	
Spire	Burnished Gold, Burnished Silver.....	\$144.00	
RODS (Available in 4' & 8' lengths)		4' - EACH	8' - EACH
1.75" Reeded Rod	Burnished Gold, Burnished Silver.....	\$78.00	\$154.00
2.5" Reeded Rod	Burnished Gold, Burnished Silver.....	\$104.00	\$209.00
1" Secondary Rod	Burnished Gold, Burnished Silver.....	\$38.00	\$74.00
BRACKETS		1.75" - EACH	2.5" - EACH
Ormolu Standard Extension Bracket	Burnished Gold, Burnished Silver.....	\$25.00	\$25.00
Rope Standard Extension Bracket	Burnished Silver	\$25.00	\$25.00
Hanging Bracket		EACH	
Hanging Bracket		Burnished Gold, Burnished Silver..... \$6.00	
Inside Mount		1.75" - PAIR	2.5" - PAIR
Inside Mount		Burnished Gold, Burnished Silver.....	\$46.00 \$52.00
TIEBACKS		PAIR	
Ormolu	Burnished Gold, Burnished Silver.....	\$118.00	
Rope	Burnished Gold, Burnished Silver.....	\$118.00	
OTHER		EACH	
Finial Adapter.....	Burnished Gold, Burnished Silver.....	\$19.00	
Bracket Rosette	Burnished Gold, Burnished Silver.....	\$8.00	
Secondary Rod Connector	N/A.....	\$4.00	
End Caps.....		1.75" - EACH	2.5" - EACH
End Caps.....		Burnished Gold, Burnished Silver.....	\$28.00 \$32.00
Rings		1.75" - PKG	2.5" - PKG
Rings		Burnished Gold, Burnished Silver.....	\$72.00 \$74.00

- Standard brackets have a 3.5"-5.5" projection
- Brackets are sold separately. 2 brackets are recommended for 4ft rods, 3 brackets are recommended for 8ft rods.

Standard drapery rods are considered to be decorative drapery hardware. While standard drapery rods are also functional, some collections are more appropriate for stationary treatments than others. Standard drapery rods may be less appropriate for windows that require day-to-day functionality. Please contact Robert Allen Customer Service for further information.

**ROBERT ALLEN DRAPERY HARDWARE
COUNTRY IRON COLLECTION**

Description	Finishes	Wholesale	
FINIALS		PAIR	
Knot	Antique, Black, Desert	\$84.00	
Loop.....	Antique, Black, Desert	\$72.00	
Scroll.....	Antique, Black, Desert	\$94.00	
Sphere.....	Antique, Black, Desert	\$45.00	
Spiral	Antique, Black, Desert	\$60.00	
Twist	Antique, Black, Desert	\$84.00	
RODS (Available in 4' & 8' lengths)		4' - EACH	8' - EACH
.75" Standard Rod	Antique, Black, Desert	\$39.00	\$78.00
.75" Secondary Rod	Antique, Black, Desert	\$39.00	\$78.00
BRACKETS		EACH	
Standard Bracket.....	Antique, Black, Desert	\$9.00	
Decorative Bracket	Antique, Black, Desert	\$39.00	
Hanger Bracket.....	Antique, Black, Desert	\$6.00	
Inside Mount.....		PAIR	
Antique, Black, Desert		\$24.00	
TIEBACKS		PAIR	
Sphere.....	Antique, Black, Desert	\$30.00	
Twist	Antique, Black, Desert	\$98.00	
OTHER		PACKAGE	
1" Ring.....	Antique, Black, Desert	\$16.00	
1" Ring w/Clip	Antique, Black, Desert	\$22.00	
Connector.....		EACH	
N/A.....		\$5.00	
End Cap.....	Antique, Black, Desert	\$12.00	

- Standard brackets have a 4.5" projection that extends to 6.5". Decorative brackets have a 3.5" projection.
- Brackets are sold separately. 2 brackets are recommended for 4ft rods, 3 brackets are recommended for 8ft rods.

Standard drapery rods are considered to be decorative drapery hardware, while traverse rod options provide both decorative and functional capabilities. While standard drapery rods are also functional, some collections are more appropriate for stationary treatments than others. This collection was designed to be special and unique for the designer to achieve a truly beautiful design statement, yet functional when the traverse rod option is selected. Standard drapery rods may be less appropriate for windows that require day-to-day functionality. Please contact Robert Allen Customer Service for further information.

**ROBERT ALLEN DRAPERY HARDWARE
FERRAFORTE COLLECTION**

Description	Finishes	Wholesale	
FINIALS		PAIR	
Academy.....	Antique Brass, Black, Earth Rust, Georgian Copper, Georgian Gold, Pewter.....	\$52.00	
Century.....	Antique Brass, Black, Earth Rust, Georgian Copper, Georgian Gold, Pewter.....	\$36.00	
Globe.....	Antique Brass, Black, Earth Rust, Pewter.....	\$70.00	
Helixa.....	Black, Earth Rust, Georgian Copper, Georgian Gold.....	\$98.00	
Jester.....	Black, Earth Rust, Georgian Copper, Georgian Gold.....	\$108.00	
Key.....	Antique Brass, Black, Earth Rust, Georgian Copper, Georgian Gold, Pewter.....	\$62.00	
Pinecone.....	Black, Earth Rust, Georgian Copper, Georgian Gold.....	\$45.00	
Scepter.....	Black, Earth Rust, Georgian Copper, Georgian Gold.....	\$45.00	
Spin.....	Antique Brass, Black, Earth Rust, Pewter.....	\$98.00	
STANDARD RODS (Available in 4' & 8' lengths)		4' - EACH	8' - EACH
1" Rod.....	Antique Brass, Black, Earth Rust, Georgian Copper, Georgian Gold, Pewter.....	\$40.00	\$79.00
TRAVERSE RODS (Available in 4' & 8' lengths)		4' - EACH	8' - EACH
1" Traverse Rod.....	Black, Earth Rust, Georgian Copper, Georgian Gold.....	\$124.00	\$184.00
1" Center Draw System.....	Black, Earth Rust, Georgian Copper, Georgian Gold.....	\$62.00	\$72.00
1" One-Way Draw System.....	Black, Earth Rust, Georgian Copper, Georgian Gold.....	\$34.00	\$54.00
BRACKETS		EACH	
Standard Bracket.....	Antique Brass, Black, Earth Rust, Georgian Copper, Georgian Gold, Pewter.....	\$8.00	
Extended Bracket 5.5".....	Antique Brass, Black, Earth Rust, Georgian Copper, Georgian Gold, Pewter.....	\$10.00	
Extended Bracket 8".....	Antique Brass, Black, Earth Rust, Georgian Copper, Georgian Gold, Pewter.....	\$14.00	
Top Mount Bracket For Traverse Rod.....	Black, Earth Rust, Georgian Copper, Georgian Gold.....	\$26.00	
INSIDE MOUNT		PAIR	
Inside Mount.....	Antique Brass, Black, Earth Rust, Georgian Copper, Georgian Gold, Pewter.....	\$16.00	
TIEBACKS		PAIR	
Pinecone.....	Black, Earth Rust, Georgian Copper, Georgian Gold.....	\$38.00	
Radius.....	Black, Earth Rust, Georgian Copper, Georgian Gold, Pewter.....	\$59.00	
SHORT POST/FEMALE TIEBACK		EACH	
Short Post/Female Tieback..	Antique Brass, Black, Earth Rust, Georgian Copper, Georgian Gold, Pewter.....	\$12.00	
ROSETTES		EACH	
1" Hammered.....	Antique Brass, Black, Earth Rust, Georgian Copper, Georgian Gold, Pewter.....	\$8.00	
2" Small.....	Antique Brass, Black, Earth Rust, Georgian Copper, Georgian Gold, Pewter.....	\$8.00	
2.5" Large.....	Antique Brass, Black, Earth Rust, Georgian Copper, Georgian Gold, Pewter.....	\$9.00	
OTHER		PACKAGE	
1.5" Ring.....	Antique Brass, Black, Earth Rust, Georgian Copper, Georgian Gold, Pewter.....(10 Rings).....	\$32.00	
Glides.....	Black.....(10 Glides).....	\$6.00	

**ROBERT ALLEN DRAPERY HARDWARE
FERRAFORTE COLLECTION *continued***

Description	Finishes	Wholesale
1" Traverse Rod Connector .. N/A.....		<i>EACH</i> \$18.00
1" Corner Angle Connector	Antique Brass, Black, Earth Rust, Georgian Copper, Georgian Gold, Pewter	\$38.00
1" End Cap	Antique Brass, Black, Earth Rust, Georgian Copper, Georgian Gold, Pewter	\$12.00
Wand	Antique Brass, Black, Earth Rust, Georgian Copper, Georgian Gold, Pewter	\$46.00

- Standard brackets have a 3.5" projection. Extended brackets 5.5" have a 5.5" projection. Extended brackets 8" have a 8" projection.
- Brackets are sold separately for standard and traverse rods. 2 brackets are recommended for 4ft rods, 3 brackets are recommended for 8ft rods.

PREMIUM TRAVERSE SYSTEM FEATURES

- Hand-draw traverse rods available in 1" diameters, and in 4' & 8' lengths. One-way draw and center draw traverse options available.
- Hand-draw traverse adds the utility of full drapery movement across the entire rod due to specially-designed top-mount brackets.
- 1" rod includes nylon glides.
- One-way hand-draw traverse rod system includes 16 glides for 4' rods and 32 glides for 8' rods, one master carrier with arm and 2 end stops.
- One-way draw features reversible master carrier arm so draw can either be from the left side or the right side.
- Center draw traverse rod system includes 16 glides for 4' rods and 32 glides for 8' rods, pair of master carriers with overlap arm and standard arm, and 2 end stops. The master carrier arms (standard and overlap) are reversible that so that the overlap can be left over right or right over left.
- The use of a wand is strongly recommended for traverse rods.
- Use a splice to connect two traverse rods together.

Standard drapery rods are considered to be decorative drapery hardware, while traverse rod options provide both decorative and functional capabilities. While standard drapery rods are also functional, some collections are more appropriate for stationary treatments than others. This collection was designed to be special and unique for the designer to achieve a truly beautiful design statement, yet functional when the traverse rod option is selected. Standard drapery rods may be less appropriate for windows that require day-to-day functionality. Please contact Robert Allen Customer Service for further information.

ROBERT ALLEN DRAPERY HARDWARE FORGED COLLECTION

Description	Finishes	Wholesale		
FINIALS		PAIR		
Ball.....	Black, Gunmetal, Patina, Rust	\$62.00		
Button End Cap	Black, Gunmetal, Patina, Rust	\$45.00		
Dart.....	Black, Gunmetal, Patina, Rust	\$62.00		
Floral End Cap.....	Black, Gunmetal, Patina, Rust	\$45.00		
Leaf.....	Black, Gunmetal, Patina, Rust	\$64.00		
Spear	Black, Gunmetal, Patina, Rust	\$62.00		
STANDARD RODS (Available in 4', 6' & 8' lengths)		4' - EACH	6' - EACH	8' - EACH
Standard Rod	Black, Gunmetal, Patina, Rust	\$42.00	\$64.00	\$84.00
BRACKETS		EACH		
Standard Bracket.....	Black, Gunmetal, Patina, Rust	\$18.00		
Extended Bracket Arm (Use With Standard Bracket)	Black, Gunmetal, Patina, Rust.....	\$14.00		
Pass Through Bracket	Black, Gunmetal, Patina, Rust	\$38.00		
CORNER BRACKETS		PAIR		
Corner Bracket (Projects 7-9")	Black, Gunmetal, Patina, Rust	\$79.00		
Inside Mount.....	Black, Gunmetal, Patina, Rust	\$24.00		
RINGS		PACKAGE		
1.5" Rings	Black, Gunmetal, Patina, Rust	(10 Rings)..... \$42.00		
OTHER		EACH		
2.75" Elbow Connector	Black, Gunmetal, Patina, Rust	\$38.00		
40" L Wand	Black, Gunmetal, Patina, Rust	\$46.00		

• Brackets are sold separately. 2 brackets are recommended for 4ft and 6ft rods, 3 brackets are recommended for 8ft rods.

Standard drapery rods are considered to be decorative drapery hardware. While standard drapery rods are also functional, some collections are more appropriate for stationary treatments than others. Standard drapery rods may be less appropriate for windows that require day-to-day functionality. Please contact Robert Allen Customer Service for further information.

ROBERT ALLEN DRAPERY HARDWARE METROPOLITAN COLLECTION

Description	Finishes	Wholesale		
FINIALS				PAIR
Ball.....	Antique Silver, Black, Bronze, Chrome, Stainless Steel.....			\$38.00
Lucent.....	Antique Silver, Black, Bronze, Chrome, Stainless Steel.....			\$38.00
Metro	Antique Silver, Black, Bronze, Chrome, Stainless Steel.....			\$32.00
RODS (Available in 4', 6' & 8' lengths)				
		4' - EACH	6' - EACH	8' - EACH
1.125" Standard Rod	Black, Bronze, Chrome, Stainless Steel.....	\$48.00	\$72.00	\$92.00
1.125" Traverse Rod.....	Antique Silver, Black, Bronze	\$42.00	\$64.00	\$84.00
BRACKETS				EACH
Standard Bracket.....	Black, Bronze, Chrome, Stainless Steel.....			\$18.00
Extended Bracket	Black, Bronze, Chrome, Stainless Steel.....			\$25.00
2" Bracket Extension Rod.....	Antique Silver, Black, Bronze, Chrome, Stainless Steel.....			\$8.00
Inside Mount Bracket.....	Antique Silver, Black, Bronze, Chrome, Stainless Steel.....			\$22.00
Traverse Standard Bracket.....	Antique Silver, Black, Bronze			\$9.00
Traverse Extended Bracket.....	Antique Silver, Black, Bronze			\$10.00
OTHER				PACKAGE
1.75" Rings	Black, Bronze, Chrome, Stainless Steel.....	(10 Rings)		\$32.00
Roller Glides	White	(16 pcs)		\$12.00
				PAIR
.75" End Cap	Antique Silver, Black, Bronze, Chrome, Stainless Steel			\$12.00
				EACH
36" L Wand	Silver, Bronze			\$12.00
Standard Rod Connector.....	n/a.....			\$9.00
Traverse Connector.....	n/a.....			\$8.00
Master Carrier With Overlap Arm .White				\$0.00
Master Carrier With Straight Arm White				\$8.00

- Brackets are sold separately for standard and traverse rods. 2 brackets are recommended for 4ft and 6ft rods, 3 brackets are recommended for 8ft rods.
- Choose either a 2" bracket projection or a 4" bracket projection. A 2" Extension Rod can be used in conjunction with a 4" bracket for a total of 6" of bracket projection.

PREMIUM TRAVERSE SYSTEM FEATURES

- One way hand-draw traverse rod systems are available in 1.125" diameter rods, and in 4', 6' and 8' lengths.
- Hand-draw traverse adds the utility of full drapery movement across the entire rod due to specially-designed rear-mount brackets.
- 1.125" traverse rod includes nylon glides. Roller glides are available separately for purchase for heavier treatments.
- One-way hand-draw traverse rod system includes 16 glides for 4' rods, 24 glides for 6' rods, and 32 glides for 8' rods, one master carrier with arm and 2 end stops.
- The master carrier with overlap arm is reversible that so that the draw can either be from the left side or the right side.
- The master carrier with straight arm is available separately for purchase to reconfigure the track for center draw operation.
- The use of a wand is strongly recommended for traverse rods.
- Use a splice to connect two traverse rods together.

Standard drapery rods are considered to be decorative drapery hardware, while traverse rod options provide both decorative and functional capabilities. While standard drapery rods are also functional, some collections are more appropriate for stationary treatments than others. This collection was designed to be special and unique for the designer to achieve a truly beautiful design statement, yet functional when the traverse rod option is selected. Standard drapery rods may be less appropriate for windows that require day-to-day functionality. Please contact Robert Allen Customer Service for further information.

**ROBERT ALLEN DRAPERY HARDWARE
PARISIAN COLLECTION**

Description	Finishes	Wholesale		
FINIALS		1.5" - PAIR	2.25" - PAIR	
Acanthus.....	Mahogany, Oak, Vintage Gold, Walnut	\$42.00.....	\$64.00	
Arbor.....	Mahogany, Oak, Vintage Gold, Walnut	\$42.00.....	\$64.00	
Chateau.....	Mahogany, Oak, Vintage Gold, Walnut	\$42.00.....	\$64.00	
Courtyard.....	Mahogany, Oak, Vintage Gold, Walnut	\$42.00.....	\$64.00	
Garland.....	Mahogany, Oak, Vintage Gold, Walnut	\$42.00.....	\$64.00	
Marquee	Mahogany, Oak, Vintage Gold, Walnut	\$49.00.....	\$70.00	
Trellis	Mahogany, Oak, Vintage Gold, Walnut	\$49.00.....	\$70.00	
RODS (Available in 4', 6' & 8' lengths)		4' - EACH	6' - EACH	8' - EACH
1.5" Standard Rod	Mahogany, Oak, Vintage Gold, Walnut	\$54.00.....	\$80.00.....	\$104.00
2.25" Standard Rod	Mahogany, Oak, Vintage Gold, Walnut	\$105.00.....	\$164.00.....	\$209.00
1.5" Fluted Rod.....	Mahogany, Oak, Vintage Gold, Walnut	\$64.00.....	\$92.00.....	\$112.00
2.25" Fluted Rod.....	Mahogany, Oak, Vintage Gold, Walnut	\$116.00.....	\$175.00.....	\$222.00
.75" Secondary Rod	Mahogany, Oak, Vintage Gold, Walnut	\$28.00.....	\$35.00.....	\$42.00
TRAVERSE RODS (Available in 4', 6' & 8' lengths)		4' - EACH	6' - EACH	8' - EACH
2.25" Standard Traverse Rod.....	Mahogany, Oak, Vintage Gold, Walnut	\$48.00.....	\$88.00.....	\$116.00
2.25" Fluted Traverse Rod.....	Mahogany, Oak, Vintage Gold, Walnut	\$48.00.....	\$88.00.....	\$116.00
2.25" Single Track Hand-Draw System	Brown	\$39.00.....	\$56.00.....	\$68.00
2.25" Single Track Corded System.....	Brown	\$92.00.....	\$112.00.....	\$134.00
2.25" Single Track Hand-Draw C-Ring System	Brown	\$39.00.....	\$49.00.....	\$56.00
2.25" Single Track Corded C-Ring System	Brown	\$84.00.....	\$94.00.....	\$102.00
2.25" Double Track Hand-Draw System.....	Brown	\$78.00.....	\$112.00.....	\$136.00
2.25" Double Track Corded System	Brown	\$184.00.....	\$224.00.....	\$268.00
2.25" Double Track Hand-Draw C-Ring System....	Brown	\$78.00.....	\$98.00.....	\$112.00
2.25" Double Track Corded C-Ring System	Brown	\$168.00.....	\$188.00.....	\$204.00
BRACKETS		.75" - EACH	1.5" - EACH	2.25" - EACH
Standard Bracket.....	Mahogany, Oak, Vintage Gold, Walnut	\$22.00	\$28.00	\$28.00
Standard Double Bracket	Mahogany, Oak, Vintage Gold, Walnut	\$28.00	\$32.00	\$32.00
Garland Bracket.....	Mahogany, Oak, Vintage Gold, Walnut	\$28.00	\$32.00	\$32.00
Garland Double Bracket	Mahogany, Oak, Vintage Gold, Walnut	\$32.00	\$38.00	\$38.00
Traverse Bracket	Brown			\$14.00
Double Traverse Bracket.....	Brown			\$16.00
Inside Mount.....	Mahogany, Oak, Vintage Gold, Walnut	\$16.00.....	\$16.00	\$16.00
TIEBACKS				PAIR
Acanthus	Mahogany, Oak, Vintage Gold, Walnut			\$46.00
Arbor.....	Mahogany, Oak, Vintage Gold, Walnut			\$46.00
OTHER				EACH
Standard Rod Connector.....	N/A			\$2.00
Traverse Rod Connector	N/A			\$12.00
Wand	Mahogany, Oak, Vintage Gold, Walnut			\$28.00

ROBERT ALLEN DRAPERY HARDWARE
PARISIAN COLLECTION *continued*

Description	Finishes	Wholesale		
		.75" - PKG	1.5" - PKG	2.25" - PKG
Standard Ring (10 Rings)	Mahogany, Oak, Vintage Gold, Walnut		\$38.00	\$52.00
Standard C-Ring (8 Rings)	Mahogany, Oak, Vintage Gold, Walnut			\$34.00
Garland Ring (10 Rings).....	Mahogany, Oak, Vintage Gold, Walnut		\$42.00	\$59.00
Garland C-Ring (8 Rings).....	Mahogany, Oak, Vintage Gold, Walnut			\$34.00
Secondary Ring (10 Rings)	Mahogany, Oak, Vintage Gold, Walnut	\$32.00		
		.75" - PKG	1.5" - PKG	2.25" - PKG
Acanthus End Cap.....	Mahogany, Oak, Vintage Gold, Walnut		\$9.00	\$10.00
Elbow Connector	Mahogany, Oak, Vintage Gold, Walnut	\$38.00	\$42.00	\$50.00
				PAIR
.75" Secondary Rod End Cap	Mahogany, Oak, Vintage Gold, Walnut			\$12.00

- 1.5" standard brackets have a 3.625" projection. 2.25" brackets have a 4" projection. 1.5" standard double brackets have a 4.625" projection for the front rod and a 2.375" projection for the back rod.
- Brackets are sold separately. 2 standard brackets are recommended for 4ft and 6ft rods, 3 standard brackets are recommended for 8ft rods

PREMIUM TRAVERSE SYSTEM FEATURES

- Premium, single and double track, center-draw traverse rod systems are available in 4', 6' and 8' lengths.
- Heavy-duty aluminum tracks are of the highest quality.
- Superior strength performance. Maximum fabric weight: 6 pounds per foot.
- Tracks are powder-coated inside and out in a brown finish, and sealed with a factory-applied dry-lubricant. This patented finishing technique allows for smooth operation and effortless glide of drapery across the rod.
- Premium hand-draw traverse system includes aluminum track(s), Klick glides (14 with 4', 22 with 6' and 28 with 8'), left and right master carriers, and end stops.
- Premium corded traverse system includes aluminum track(s), Klick glides (14 with 4', 22 with 6' and 28 with 8'), left and right master carriers, right-side cord control with 6' cord drop, mounted cord pulley, and end stops.
- C-ring system includes same as other traverse systems except track is threaded with c-ring glides and master carriers.
- 2.25" Wood Traverse Rods, C-rings, Wands, and Brackets are sold separately.
- Single track brackets are 3" long with a 2.5" projection. The double track brackets are 6" long with 5.5" projection for the front track and 1.75" projection for the back track.
- 3 traverse brackets are recommended for 4ft and 6ft rods, 4 traverse brackets are recommended for 8ft rods.

Standard drapery rods are considered to be decorative drapery hardware, while traverse rod options provide both decorative and functional capabilities. While standard drapery rods are also functional, some collections are more appropriate for stationary treatments than others. This collection was designed to be special and unique for the designer to achieve a truly beautiful design statement, yet functional when the traverse rod option is selected. Standard drapery rods may be less appropriate for windows that require day-to-day functionality. Please contact Robert Allen Customer Service for further information.

**ROBERT ALLEN DRAPERY HARDWARE
POLYNESIAN COLLECTION**

Description	Finishes	Wholesale
FINIALS		PAIR
Abaca Rope.....	Rattan, Walnut.....	\$92.00
Abalone.....	Rattan, Walnut.....	\$116.00
Banana Leaf.....	Rattan, Walnut.....	\$92.00
Capiz Shell.....	Rattan, Walnut.....	\$116.00
Kapok.....	Rattan, Walnut.....	\$92.00
Penshell.....	Rattan, Walnut.....	\$116.00
Reeded.....	Rattan, Walnut.....	\$105.00
Tiki.....	Rattan, Walnut.....	\$92.00
Tropical.....	Rattan, Walnut.....	\$95.00

RODS (Available in 4', 6' & 8' lengths)		4' - EACH	6' - EACH	8' - EACH
1.75" Standard Rod.....	Rattan, Walnut.....	\$84.00	\$128.00	\$175.00
1.75" Fluted Rod.....	Rattan, Walnut.....	\$112.00	\$154.00	\$206.00
1.75" Reeded Rod.....	Rattan, Walnut.....	\$148.00	\$222.00	\$294.00

BRACKETS		EACH
3.75" Standard Bracket.....	Rattan, Walnut.....	\$32.00
6" Extended Bracket.....	Rattan, Walnut.....	\$39.00
3.75" Abaca Rope Bracket.....	Rattan, Walnut.....	\$42.00
3.75" Reeded Bracket.....	Rattan, Walnut.....	\$48.00
3.75" Tiki Bracket.....	Rattan, Walnut.....	\$32.00
3.75" Tropical Bracket.....	Rattan, Walnut.....	\$32.00

RINGS		PACKAGE
2.5" Standard Rings.....	Rattan, Walnut.....	(10 Rings)..... \$64.00
2.5" Fluted Rings.....	Rattan, Walnut.....	(10 Rings)..... \$70.00

• Brackets are sold separately. 2 brackets are recommended for 4ft and 6ft rods, 3 brackets are recommended for 8ft rods.

Standard drapery rods are considered to be decorative drapery hardware. While standard drapery rods are also functional, some collections are more appropriate for stationary treatments than others. Standard drapery rods may be less appropriate for windows that require day-to-day functionality. Please contact Robert Allen Customer Service for further information.

**ROBERT ALLEN DRAPERY HARDWARE
PROVENCE COLLECTION**

Description	Finishes	Wholesale	
FINIALS		PAIR	
Arabesque	Antique, Black Iron, Earth Rust, Golden Brass.....	\$66.00	
Arrow	Antique, Black Iron, Earth Rust, Golden Brass.....	\$62.00	
Ball	Antique, Black Iron, Earth Rust, Golden Brass.....	\$68.00	
Fern	Antique, Black Iron, Earth Rust, Golden Brass.....	\$62.00	
Fleur De Lys	Antique, Black Iron, Earth Rust, Golden Brass.....	\$62.00	
Harp	Antique, Black Iron, Earth Rust, Golden Brass.....	\$64.00	
RODS (Available in 4' & 8' lengths)		4' - EACH	8' - EACH
1" Standard Rod	Antique, Black Iron, Earth Rust, Golden Brass.....	\$38.00	\$75.00
1.5" Standard Rod	Antique, Black Iron, Earth Rust, Golden Brass.....	\$42.00	\$82.00
1" Secondary Rod	Antique, Black Iron, Earth Rust, Golden Brass.....	\$38.00	\$69.00
TRAVERSE RODS (Available in 4' & 8' lengths)		4' - EACH	8' - EACH
1" Traverse Rod	Antique, Black Iron, Earth Rust, Golden Brass.....	\$124.00	\$184.00
1.5" Traverse Rod	Antique, Black Iron, Earth Rust, Golden Brass.....	\$140.00	\$226.00
1" Center Draw System	Antique, Black Iron, Earth Rust, Golden Brass.....	\$62.00	\$72.00
1.5" Center Draw System	Antique, Black Iron, Earth Rust, Golden Brass.....	\$84.00	\$122.00
1" One-Way Draw System	Antique, Black Iron, Earth Rust, Golden Brass.....	\$34.00	\$54.00
1.5" One-Way Draw System	Antique, Black Iron, Earth Rust, Golden Brass.....	\$60.00	\$100.00
BRACKETS		1" - EACH	1.5" - EACH
Standard Bracket	Antique, Black Iron, Earth Rust, Golden Brass.....	\$22.00	\$24.00
Double Bracket	Antique, Black Iron, Earth Rust, Golden Brass.....	\$29.00	\$29.00
Extended Bracket	Antique, Black Iron, Earth Rust, Golden Brass.....	\$24.00	\$24.00
Traverse Bracket	Antique, Black Iron, Earth Rust, Golden Brass.....	\$26.00	\$32.00
Inside Mount		1" - PAIR	1.5" - PAIR
Antique, Black Iron, Earth Rust, Golden Brass.....		\$18.00	\$20.00
TIEBACKS		PAIR	
Ball	Antique, Black Iron, Earth Rust, Golden Brass.....	\$52.00	
Curl	Antique, Black Iron, Earth Rust, Golden Brass.....	\$52.00	
OTHER		1" - EACH	1.5" - EACH
Standard Rod Connector	N/A.....	\$8.00	\$8.00
Traverse Rod Connector	N/A.....	\$18.00	\$18.00
Corner Angle Connector	Antique, Black Iron, Earth Rust, Golden Brass.....	\$38.00	\$44.00
End Cap	Antique, Black Iron, Earth Rust, Golden Brass.....	\$12.00	\$18.00

ROBERT ALLEN DRAPERY HARDWARE
PROVENCE COLLECTION *continued*

Description	Finishes	Wholesale
PACKAGE		
2" Rings	Antique, Black Iron, Earth Rust, Golden Brass.....	(10 Rings).....\$39.00
Small Glides	Black.....	(10 pcs).....\$6.00
Large Glides	Black.....	(10 pcs).....\$22.00
EACH		
40" L Wand	Antique, Black Iron, Earth Rust, Golden Brass.....	\$46.00

- 1" brackets have a 3.5" projection. 1.5" brackets have a 3.75" projection.
- Brackets are sold separately for standard and traverse rods. 2 brackets are recommended for 4ft rods, 3 brackets are recommended for 8ft rods.

PREMIUM TRAVERSE SYSTEM FEATURES

- Hand-draw traverse rods available in 4' and 8' lengths. One-way draw and center draw traverse options available.
- Hand-draw traverse adds the utility of full drapery movement across the entire rod due to specially-designed top-mount brackets.
- 1" rod includes nylon glides, 1.5" rod includes roller glides with ball bearings.
- 1" traverse rod cannot be used with finials. Can only be utilized with end caps, inside mounts, or as a secondary rod in conjunction with the double bracket.
- One-way hand-draw traverse rod system includes 16 glides for 4' rods and 32 glides for 8' rods, one master carrier with arm and 2 end stops.
- One-way draw features reversible master carrier arm so draw can either be from the left side or the right side.
- Center draw traverse rod system includes 16 glides for 4' rods and 32 glides for 8' rods, pair of master carriers with overlap arm and standard arm, and 2 end stops. The master carrier arms (standard and overlap) are reversible that so that the overlap can be left over right or right over left.
- The use of a wand is strongly recommended for traverse rods.
- Use a splice to connect two traverse rods together.

Standard drapery rods are considered to be decorative drapery hardware, while traverse rod options provide both decorative and functional capabilities. While standard drapery rods are also functional, some collections are more appropriate for stationary treatments than others. This collection was designed to be special and unique for the designer to achieve a truly beautiful design statement, yet functional when the traverse rod option is selected. Standard drapery rods may be less appropriate for windows that require day-to-day functionality. Please contact Robert Allen Customer Service for further information.

ROBERT ALLEN DRAPERY HARDWARE TOSCANA COLLECTION

Description	Finishes	Wholesale	
FINIALS			
		1.5" - PAIR	2" - PAIR
Bella	Antique, Earth Rust, Italian Gold, Limestone, Sienna	\$105.00	
Campagna	Antique, Earth Rust, Italian Gold, Limestone, Sienna	\$126.00	
Firenze	Antique, Earth Rust, Italian Gold, Limestone, Sienna		\$122.00
Loggia	Antique, Earth Rust, Italian Gold, Limestone, Sienna		\$138.00
Piazza	Antique, Earth Rust, Italian Gold, Limestone, Sienna	\$105.00	
Saxon Small	Antique, Earth Rust, Italian Gold, Limestone, Sienna	\$105.00	
Saxon Large	Antique, Earth Rust, Italian Gold, Limestone, Sienna		\$122.00
TIEBACKS			
		PAIR	
Floral	Antique, Earth Rust, Italian Gold, Limestone, Sienna	\$164.00	
Rosette	Antique, Earth Rust, Italian Gold, Limestone, Sienna	\$105.00	
RODS (Available in 4' & 8' lengths)			
		4' - EACH	8' - EACH
1.5" Plain Rod	Antique, Earth Rust, Italian Gold, Limestone, Sienna	\$70.00	\$144.00
2" Plain Rod	Antique, Earth Rust, Italian Gold, Limestone, Sienna	\$82.00	\$168.00
1.5" Rope Rod	Antique, Earth Rust, Italian Gold, Limestone, Sienna	\$264.00	\$420.00
2" Rope Rod	Antique, Earth Rust, Italian Gold, Limestone, Sienna	\$232.00	\$458.00
		EACH	
Swing Arm w/Mounting Bracket	Antique, Earth Rust, Italian Gold, Limestone, Sienna	\$116.00	
BRACKETS			
		1.5" - EACH	2" - EACH
Standard Bracket	Antique, Earth Rust, Italian Gold, Limestone, Sienna	\$34.00	\$34.00
Extended Bracket	Antique, Earth Rust, Italian Gold, Limestone, Sienna	\$38.00	\$38.00
Adapter	White	\$8.00	
		1.5" - PAIR	2" - PAIR
Inside Mount	Antique, Earth Rust, Italian Gold, Limestone, Sienna	\$26.00	\$34.00
OTHER			
		1.5" - EACH	2" - EACH
Corner Angle	Antique, Earth Rust, Italian Gold, Limestone, Sienna	\$59.00	
End Cap	Antique, Earth Rust, Italian Gold, Limestone, Sienna	\$22.00	\$28.00
Standard Connector Rod	N/A	\$6.00	\$8.00
		2" - PKG	2.5" - PKG
Rings	Antique, Earth Rust, Italian Gold, Limestone, Sienna	\$54.00	\$69.00
		(10 Rings)	(10 Rings)
		EACH	
40" L Wand	Antique, Earth Rust, Italian Gold, Limestone, Sienna	\$54.00	

- 1.5" standard brackets have a 4.25" projection. 2" standard brackets have a 4.5" projection. 1.5" extended brackets have a 6" projection. 2" extended brackets have a 6.25" projection.
- Brackets are sold separately. 2 brackets are recommended for 4ft rods, 3 brackets are recommended for 8ft rods.

Standard drapery rods are considered to be decorative drapery hardware. While standard drapery rods are also functional, some collections are more appropriate for stationary treatments than others. Standard drapery rods may be less appropriate for windows that require day-to-day functionality. Please contact Robert Allen Customer Service for further information.

ROBERT ALLEN DRAPERY HARDWARE TRADITIONS COLLECTION

Description	Finishes	Wholesale		
FINIALS				PAIR
Biltmore	Bronze, Ebony, Gilded, Platinum, Walnut w/Gold	\$92.00		
Hearst	Bronze, Ebony, Gilded, Platinum, Walnut w/Gold	\$105.00		
Monticello	Bronze, Ebony, Gilded, Platinum, Walnut w/Gold	\$100.00		
Vanderbilt.....	Bronze, Ebony, Gilded, Platinum, Walnut w/Gold	\$74.00		
Vernon	Bronze, Ebony, Gilded, Platinum, Walnut w/Gold	\$95.00		
Winterthur.....	Bronze, Ebony, Gilded, Platinum, Walnut w/Gold	\$95.00		
TIEBACKS				PAIR
Leaf Holdback.....	Bronze, Ebony, Gilded, Platinum, Walnut w/Gold	\$70.00		
Ribbed Holdback	Bronze, Ebony, Gilded, Platinum, Walnut w/Gold	\$70.00		
RODS (Available in 4', 6' & 8' lengths)				4' - EACH 6' - EACH 8' - EACH
2.25" Fluted Rod.....	Bronze, Ebony, Gilded, Platinum, Walnut Gold.....	\$112.00.....	\$164.00.....	\$218.00
BRACKETS				EACH
Standard Bracket.....	Bronze, Ebony, Gilded, Platinum, Walnut w/Gold	\$28.00		
Extended Bracket	Bronze, Ebony, Gilded, Platinum, Walnut w/Gold	\$32.00		
OTHER				PACKAGE
2.75" Rings	Bronze, Ebony, Gilded, Platinum, Walnut w/Gold	(10 rings)..... \$74.00		
1.875" End Cap	Bronze, Ebony, Gilded, Platinum, Walnut w/Gold	\$42.00		
36"L Wand	Bronze, Ebony, Gilded, Platinum, Walnut w/Gold	\$42.00		

• Brackets are sold separately. 2 brackets are recommended for 4ft rods, 3 brackets are recommended for 8ft rods.

Custom Finish Options - choose from one of 10 additional finishes that have been selected to complement the design aesthetic of this elegant collection (Silver w/Gold, Cappuccino, Soft Gold, Walnut w/Black, Flat Black w/Gold, Silver w/Black Wipe, Ivory w/Umber Rub, Venetian Gold, Bronze w/Copper, Statuary Bronze). An additional charge applies to these finishes and lead times vary from 2-4 weeks for shipment. Strike off samples will be provided for approval upon customer request.

Custom Finish Program - Send us a sample of your favorite finish and we will match it! You can also specify any Sherwin-Williams paint color and we can match that too! Additional charges apply for this service and will be quoted based on custom paint costs. Lead times vary from 3-6 weeks for shipment. Strike off samples will be provided for approval upon customer request.

Standard drapery rods are considered to be decorative drapery hardware. While standard drapery rods are also functional, some collections are more appropriate for stationary treatments than others. Standard drapery rods may be less appropriate for windows that require day-to-day functionality. Please contact Robert Allen Customer Service for further information.

ROBERT ALLEN CURRENT BOOKS

560013	540043	530020	510070	500078	690067	680055	670089
560012	540027	530011	510067	500076	690066	680054	670088
560011	540025	530009	510065	500068	690057	680053	670087
560010	540023	530008	510062	500067	690056	680052	670086
560009	540022	530007	510059	500066	690053	680051	670085
560008	540021	530006	510058	500065	690038	680047	670081
560007	540020	530005	510057	500064	690037	680046	670080
560006	540015	530004	510056	500063	690028	680045	670079
560005	540010	530003	510051	500062	690027	680044	670077
560004	540009	530002	510050	500061	690026	680043	670076
550069	540008	530001	510049	500060	690025	680042	670074
550058	540007	520071	510048	500059	690019	680040	670072
550057	540006	520068	510047	500057	690018	680039	670070
550056	540005	520066	510046	500056	690017	680038	670067
550052	540004	520065	510045	500055	690016	680037	670066
550051	540003	520064	510044	500054	690012	680036	670065
550048	540002	520055	510043	500053	690007	680035	670062
550047	540001	520054	510039	500052	690002	680034	670061
550046	530076	520053	510038	500051	684300	680030	670058
550045	530075	520050	510037	500050	684200	680028	670057
550033	530074	520049	510036	500049	680098	680027	670053
550032	530073	520046	510035	500048	680097	680026	670052
550031	530072	520038	510034	500047	680096	680024	670051
550030	530069	520037	510033	500045	680094	680021	670049
550029	530064	520036	510030	500043	680093	680020	670048
550043	530063	520034	510029	500041	680092	680019	670047
550025	530059	520032	510028	500040	680091	680018	670046
550024	530056	520031	510027	500036	680090	680017	670045
550023	530055	520029	510026	500035	680079	680014	670043
550022	530054	520028	510025	500034	680078	680012	670042
550021	530051	520027	510024	500031	680077	680011	670041
550020	530049	520024	510023	500030	680070	680010	670040
550011	530048	520021	510022	500029	680069	680009	670039
550010	530047	520020	510021	500028	680068	680006	670038
550009	530046	520019	510020	500023	680067	680005	670037
550008	530045	520018	510019	500021	680066	680004	670036
550007	530044	520017	510016	500018	680065	680003	670035
550006	530043	520015	510015	500015	680064	670099	670034
550005	530041	520014	510014	500014	680063	670097	670033
550004	530039	520013	510013	500012	680062	670096	670028
540074	530037	520012	510012	500010	680061	670094	670027
540073	530032	520011	510011	500001	680059	670093	670026
540072	530024	520010	510010	690093	680058	670092	670025
540069	530023	510076	510009	690078	680057	670091	670024
540053	530021	510075	507800	690068	680056	670090	670009

ROBERT ALLEN CURRENT BOOKS

670007	650045	620014
670006	650027	620013
670005	650012	620012
670004	650011	610070
670002	650008	610069
660500	650002	610068
660204	640099	610067
660096	640098	610044
660085	640096	610007
660079	640093	610006
660078	640089	600087
660077	640063	600038
660075	640058	600037
660070	640055	600036
660069	640045	996800
660068	640044	993000
660065	640031	992900
660053	640025	992800
660052	640022	987900
660051	640021	987800
660043	640020	987700
660033	630052	983800
660021	630030	983700
660012	630029	983600
650089	630028	976800
650088	620091	976700
650068	620090	972900
650053	620089	972800
650052	620088	
650051	620081	
650049	620022	

ROBERT ALLEN TERMS AND CONDITIONS OF SALE

ACCEPTANCE OF TERMS AND CONDITIONS

These terms and conditions of sale shall govern this order and buyer shall be deemed to have agreed to them. Any attempt to change or add to these terms by buyer, or any conflicting terms on any correspondence, purchase order, or other form sent by buyer is hereby objected to and rejected. Buyer shall be deemed to have agreed to these terms and conditions of sale by issuance of an order, by accepting delivery or by making payment hereunder. No oral agreement, course of prior dealings between the parties or trade usage shall amend or supplement any of the terms or conditions herein. All of the terms and conditions of this order and sale appear on this form and no additions or modifications can be made except in a writing signed by both parties that expressly references the amendment of these terms. All references herein to the seller or the company shall mean The Robert Allen Group.

MINIMUM ORDERS

Minimum order requirements for all cut yardage is one yard for fabrics and trim. Incremental yardage is 1/4 yard. Orders received for cuts other than 1/4 yard will be rounded up to the next 1/4 yard increment and billed at that amount. Leather is sold by full hides. Certain hardware is sold in pairs.

DYE LOT AND OTHER VARIATIONS; INHERENT IMPERFECTIONS

Color will vary from piece to piece and the company does not guarantee the dye lot. For exact match, request cutting and reserve for approval. In the absence of such request and reserve, the company shall have no liability for variations in color, dye lot or shade. Some collections contain products that are hand-painted or manufactured by hand; slight variances in color, texture and/or weave may occur. There may also be inherent imperfections in certain fibers, metals, leathers or fabrics. None of the foregoing shall be considered defects.

CLIMATIC CONDITIONS; SUITABLE APPLICATIONS; C.O.M. FABRIC

Climatic conditions, including heat, light and humidity levels, within the user's environment, can affect fabric and wood, and may lead to fading, stretching, shrinking or other damage. Fabric displayed in sample books and memo samples describes the intended application thereof. Hardware is considered a decorative product; while it is also functional, some collections are more appropriate for stationary treatments and others for windows requiring functionality. The selection of hardware, furniture or fabrics for specific placements or applications is made at the discretion and sole risk of the buyer and the company shall have no liability for such selections. Accordingly, buyers are urged to review the suitability of such choices and any other questions with the company's Customer Service Department before ordering and to allow sufficient fabric for environmental effects. The company shall have no liability for the buyer's C.O.M. fabric, its suitability, performance or condition. The company does not guarantee roll direction and is not responsible for errors in application due to roll direction.

FLAME RETARDANT PROPERTIES; TOPICAL TREATMENTS

In accordance with the provisions of the Flammable Fabrics Act, as amended, this merchandise is not intended for use in the manufacture of wearing apparel. Flame retardant chemicals can cause skin irritation, fabric spotting and/or stitching problems. In addition, all of the flame retardancy may be removed through machine washing and/or dry cleaning of the fabric. Accordingly, the company shall have no liability for any losses, claims or damage resulting from flame retardant chemicals. Adding topical treatments to any fabric may alter the performance, quality, color or hand. The company shall have no responsibility for damage to any fabric treated beyond regular finishes applied at the mill level.

CREDIT AND PAYMENT TERMS; OFFSETS

Acceptance of orders and shipments shall at all times be subject to approval by the company's Credit Department, which may at any time in its sole discretion decline to make any shipment except upon terms and conditions satisfactory to it. Subject to credit approval, terms of payment for all goods other than furniture or custom orders are net 30 days from the date of the invoice. All orders are subject to the absolute right of the company to require payment of all or any part of the purchase price in advance of delivery. Furniture and custom orders require a minimum deposit of 50% with order and payment of the balance in full prior to shipment. Interest will be charged on all past due accounts at the maximum rate permitted by applicable law. Seller accepts credit cards on new orders only. Credit cards cannot be used to pay open balances. Any indebtedness of buyer to the company may at the company's option be credited against amounts owed by the company to buyer. Payments received by the company from the buyer may be applied to any past due invoice or account of the buyer.

DELIVERY SCHEDULES; SHIPPING AND CHARGES; TITLE

In stock cut yardage orders are generally shipped within 24 hours from receipt of a credit-approved order. Furniture, custom, special-order and non-stock orders have longer lead times. Delivery dates supplied by the company represent its best estimate, but are in no way guarantees of delivery. Accordingly, the company shall have no liability for delays in delivery or failure to meet estimated delivery dates. Sometimes circumstances beyond our control affect availability; therefore, the company reserves the right to cancel any backorder. All shipments are made F.O.B. point of origin. All orders are subject to shipping and/or handling charges. Title to goods passes upon payment in full; risk of loss passes upon delivery to buyer's common carrier.

NON-DELIVERY OF FURNITURE

The company shall charge a storage fee to the buyer for any furniture for which the balance has not been paid in full and/or for which delivery instructions have not been given within thirty (30) days after receipt by the receiver. If full payment and delivery arrangements have not been made by Buyer within sixty (60) days after receipt by the receiver, the company shall have the right to sell or otherwise dispose of such furniture in a commercially reasonable manner. In such event, the company's sole liability to buyer (or buyer's customer or the end-user) shall be to reimburse the buyer for payments made after deduction by the company for its cost of goods, its customary profit thereon and all unreimbursed expenses of shipping, storage and sale thereof.

CANCELLATIONS OF ORDERS

Any cancellation of an order must be made in writing within five (5) business days of the order date. Notwithstanding the foregoing, no cancellations will be accepted if production of the order has commenced, including without limitation, cutting of fabric. If production has not commenced and the cancellation is accepted, the buyer's deposit will be refunded.

RETURNS AND CLAIMS

No merchandise may be returned without the company's prior approval and instruction. No returns on Beacon Hill fabric under 1 yard; for all others, no returns on upholstery fabric under 5 yards or drapery fabric under 9 yards. No returns of floor samples or sale items, which are sold "as is" and for which all sales are final. No returns of goods that have been cut, treated, altered, processed, subject to abuse or misuse, or damaged after shipment by seller. No returns of velvets, custom products or special-ordered goods. All authorized returns must be in original wrapping materials in the same condition as when received by buyer. All authorized returns within 30 days of invoice date will be subject to in/out freight and handling charges. All authorized returns after 30 days but within 60 days of invoice date will be subject to a 25% restocking charge, plus in/out freight and handling charges. No returns for any reason after 60 days. Claims for damage to furniture in transit for delivery to buyer or buyer's customer, workroom or other agent are buyer's responsibility; all goods should be inspected upon arrival and a claim filed with the carrier if damage has occurred in shipment.

NO THIRD PARTY BENEFICIARIES

No third party shall have any rights with respect to this sale transaction, on any legal or equitable theory of reliance, contract or otherwise, and the company shall have no liability to any such third party, including without limitation, a customer of the buyer or an end user of the company's products. The company sells "to the trade" only and not directly to consumers; any signatures or payments made by consumers with respect to this transaction shall be deemed to have been made as a convenience only as agent for the trade buyer named herein.

NON-CONFORMING OR DEFECTIVE PRODUCTS

The company reserves the right to repair or replace any defective or non-conforming product, as provided below. All products must be inspected by the buyer or buyer's customer, workroom or other agent, within ten (10) days after receipt and all defects or damages not sustained in shipment must be promptly reported to the company's Customer Service Department. All shipments received and signed for by buyer's receiver must be inspected for damage prior to acceptance and the company must be notified promptly of any problem. All returns for defects must have prior authorization and instructions from the company and must be returned in their original package and in the same condition as when received. If verified by the company to be defective, products will be accepted within sixty (60) days after receipt for repair or replacement, at the company's sole option. The company will pay all return in/out freight and handling charges in such verified cases. If, upon inspection of an authorized return, the company determines that the claim is unsubstantiated, the return will be rejected and return in/out freight, handling and restocking charges will be assessed. Charges for local repairs will not be accepted without prior authorization from the company. The foregoing provisions shall constitute the buyer's sole remedy with respect to defective or non-conforming goods. In no event shall seller be liable for any customary variations within industry standards or for imperfections inherent in certain fibers, leathers, metals, fabrics or woods.

ADVERTISING

All advertising of the company's products must be dignified, tasteful and professional. Use of seller's trademarks, tradenames, logos, copyrighted materials, digital images or other proprietary materials, in any medium (including without limitation, over the internet), without prior written approval by the company, is strictly prohibited and may subject an unauthorized user to legal action by the company. By purchasing the Goods, Buyer agrees to abide by Seller's minimum advertised pricing policy, available at www.robertalldesign.com/terms.html.

DISCLAIMER OF WARRANTIES; LIMITATION ON LIABILITY

UNLESS OTHERWISE EXPRESSLY OFFERED BY THE FABRIC, HARDWARE OR FURNITURE MANUFACTURER AND INDICATED IN WRITING BY THE COMPANY, SELLER DISCLAIMS ALL WARRANTIES, EXPRESS OR IMPLIED, INCLUDING, BUT NOT LIMITED TO, WARRANTIES OF FITNESS FOR A PARTICULAR PURPOSE OR OF MERCHANTABILITY. IN THE EVENT OF SELLER'S LIABILITY, WHETHER BASED IN CONTRACT, TORT, NEGLIGENCE, STRICT LIABILITY OR OTHERWISE, BUYER'S SOLE AND EXCLUSIVE REMEDY WILL BE LIMITED AS SET FORTH IN THE SECTION ENTITLED "NON-CONFORMING OR DEFECTIVE PRODUCTS", TO REPAIR OR REPLACEMENT BY SELLER OF ANY DEFECTIVE OR NON-CONFORMING GOODS FOR WHICH TIMELY CLAIM MAY BE MADE BY BUYER. SELLER EXPRESSLY DISCLAIMS ANY LIABILITY TO BUYER, ITS CUSTOMERS OR TO END USERS OF ITS PRODUCTS, FOR SPECIAL, INCIDENTAL, PUNITIVE OR CONSEQUENTIAL DAMAGES, INCLUDING DAMAGE TO OR LOSS OF OTHER PROPERTY OR EQUIPMENT, PERSONAL INJURY, LOSS OF PROFITS, BUSINESS OR REVENUES, OR COST OR OTHER DAMAGE, LOSS OR EXPENSE FROM ANY CAUSE WHATSOEVER, ARISING OUT OF OR IN ANY WAY CONNECTED WITH THE SALE OR USE OF ITS PRODUCTS. THE MAXIMUM LIABILITY, IF ANY, OF SELLER FOR ALL DAMAGES HEREUNDER IS LIMITED TO THE PURCHASE PRICE OF THE DEFECTIVE OR NON-CONFORMING PRODUCTS SOLD PURSUANT TO THIS TRANSACTION. ANY ACTION ARISING HEREUNDER MUST BE BROUGHT WITHIN ONE YEAR FROM THE DATE OF SALE. SOME STATES DO NOT ALLOW THE EXCLUSION OR LIMITATION OF WARRANTIES, CONSEQUENTIAL DAMAGES OR REMEDIES, OR LIMITATION ON THE TIME FRAMES INVOLVED IN SAME, IN WHICH EVENT THESE LIMITATIONS MAY NOT APPLY TO YOU.

COLLECTION; GOVERNING LAW; FORCE MAJEURE

In any action for the collection of, or to enforce payment of, all or part of the purchase price of the products sold to buyer, seller shall be entitled to recover all reasonable collection fees, attorney's fees and costs, to the extent permitted by law. This transaction shall be governed by and enforced in accordance with the substantive laws of the State of New York, without regard to principles of conflicts of laws, and buyer hereby consents to the personal jurisdiction of the federal and state courts located in New York, New York. The company shall not be liable for delay or failure in performance hereunder arising from any act of God or nature, strike, labor disruption, government action, lack of materials or other cause not within its control.

Possession of this Price List and Catalogue does not necessarily constitute authority to purchase and the furnishing of them does not constitute an offer by the company to sell any of the items contained herein. Beacon Hill®, Robert Allen®, Robert Allen Contract™, Robert Allen @ Home®, Ametex®, and Ametex Contract™, are trademarks and tradenames of The Robert Allen Group, Inc., protected under federal and state laws, and may not be used without the company's express approval. Copyright © 2015 by The Robert Allen Group, Inc. This price list replaces all prior price lists; all prices, terms, conditions and fabric specifications are subject to change by the company at any time without advance notice.

USA

2 Hampshire Street
Suite 300
Foxboro, MA 02035
T 800.333.3777
F 800.332.8256

CANADA

2880 Argentia Road
Unit Eleven
Mississauga, ON L5N 7X8
T 800.363.3020
F 800.463.0339

UK

Chiltern House, The Valley Centre
Gordon Road,
High Wycombe, Buckinghamshire
HP13 6EQ England
T +44 (0) 1494.474741
F +44 (0) 1494.603400



USA 800.333.3778
CANADA 800.363.3020
EUROPE + 44 (0) 1494 474741

YOUR SEARCH ENDS HERE. RobertAllenDesign.com



WHOLESALE
TRADE PRICE LIST
EFFECTIVE
JANUARY 15, 2015

ROBERT ALLEN

DRAPERY HARDWARE

TABLE OF CONTENTS

Al Fresco	1
Architrave	2-3
Bedpost	4
Casual Elegance	5-6
Chess Hardware	7-8
Classic Hardware	9
Costume	10
Country Iron	11
Ferraforte	12-13
Forged Iron	14
Metropolitan	15
Parisian	16-17
Polynesian	18
Provence	19-20
Toscana	21
Traditions	22

ROBERT ALLEN

ROBERT ALLEN DRAPERY HARDWARE

AL FRESCO COLLECTION

Description	Finishes	Wholesale	
FINIALS		1" - PAIR	1.5" - PAIR
Coral.....	Coral.....	\$124.00.....	\$124.00
Hammered Ball.....	Black, Bronze, Pewter, Silver.....	\$46.00.....	\$84.00
Lantern.....	Black, Bronze, Pewter, Silver.....		\$118.00
Palm Leaf.....	Black, Bronze, Pewter, Silver.....	\$78.00.....	\$78.00
Pinecone.....	Black, Bronze, Pewter, Silver.....	\$46.00.....	\$84.00
STANDARD RODS (Available in 4' & 8' lengths)		4' - EACH	8' - EACH
1" Standard Rod.....	Black, Bronze, Coral, Pewter, Silver.....	\$46.00.....	\$84.00
1.5" Standard Rod.....	Black, Bronze, Coral, Pewter, Silver.....	\$58.00.....	\$104.00
TRAVERSE RODS (Available in 4' & 8' lengths)		4' - EACH	8' - EACH
1" Traverse Rod.....	Black, Bronze, Coral, Pewter, Silver.....	\$104.00.....	\$168.00
1.5" Traverse Rod.....	Black, Bronze, Coral, Pewter, Silver.....	\$118.00.....	\$202.00
1" One-Way Draw System.....	Black, Bronze, Coral, Pewter, Silver.....	\$34.00.....	\$54.00
1.5" One-Way Draw System.....	Black, Bronze, Coral, Pewter, Silver.....	\$36.00.....	\$59.00
BRACKETS		1" - EACH	1.5" - EACH
Standard Bracket.....	Black, Bronze, Coral, Pewter, Silver.....	\$10.00.....	\$12.00
Traverse Bracket.....	Black, Bronze, Coral, Pewter, Silver.....	\$26.00.....	\$32.00
TIEBACKS			PAIR
Ball Tieback.....	Black, Bronze, Coral, Pewter, Silver.....		\$65.00
OTHER			EACH
1" Standard Rod Connector.....	N/A.....		\$12.00
1.5" Standard Rod Connector.....	N/A.....		\$12.00
1" Traverse Rod Connector.....	N/A.....		\$22.00
1.5" Traverse Rod Connector.....	N/A.....		\$22.00
1" End Cap.....	Black, Bronze, Coral, Pewter, Silver.....		\$14.00
1.5" End Cap.....	Black, Bronze, Coral, Pewter, Silver.....		\$16.00
Wand.....	Black, Bronze, Coral, Pewter, Silver.....		\$46.00
			PACKAGE
Drapery Hooks.....	N/A.....	(10 pcs).....	\$8.00
Glides.....	Black.....	(10 Glides).....	\$19.00
1.5" Ring.....	Black, Bronze, Coral, Pewter, Silver.....	(10 Rings).....	\$36.00
2" Ring.....	Black, Bronze, Coral, Pewter, Silver.....	(10 Rings).....	\$42.00

- 1" brackets have a 3.5" projection. 1.5" brackets have a 3.75" projection.
- Brackets are sold separately for standard and traverse rods. 2 brackets are recommended for 4ft rods, 3 brackets are recommended for 8ft rods.

PREMIUM TRAVERSE SYSTEM FEATURES

- Hand-draw traverse rods are available in 1" & 1.5" diameters, and 4' & 8' lengths. Reversible one-way draw traverse options available.
- Hand-draw traverse adds the utility of full drapery movement across the entire rod due to specially-designed top-mount brackets.
- 1" and 1.5" rods include rust-proof roller glides for smooth and easy movement of draperies.
- One-way hand-draw traverse rod system includes 16 glides for 4' rods and 32 glides for 8' rods, one master carrier with arm and 2 end stops.
- One-way draw features reversible master carrier arm so that draw can either be from the left side or the right side.
- The use of a wand is strongly recommended for traverse rods.
- Use a splice to connect two traverse rods together.

Standard drapery rods are considered to be decorative drapery hardware, while traverse rod options provide both decorative and functional capabilities. While standard drapery rods are also functional, some collections are more appropriate for stationary treatments than others. This collection was designed to be special and unique for the designer to achieve a truly beautiful design statement, yet functional when the traverse rod option is selected. Standard drapery rods may be less appropriate for windows that require day-to-day functionality. Please contact Robert Allen Customer Service for further information.

**ROBERT ALLEN DRAPERY HARDWARE
ARCHITRAVE COLLECTION**

Description	Finishes	Wholesale	
FINIALS		1" - PAIR	1.5" - PAIR
Axis.....	Antique, Antique Gold, Earth Rust, Watermark Silver	\$132.00	
Caliz.....	Antique, Antique Gold, Earth Rust, Watermark Silver	\$114.00	
Pino	Antique, Antique Gold, Earth Rust, Watermark Silver	\$75.00	
Pomegranate	Antique, Antique Gold, Earth Rust, Watermark Silver	\$75.00	
Quatrefoil.....	Antique, Antique Gold, Earth Rust, Watermark Silver	\$102.00	
Turban	Antique, Antique Gold, Earth Rust, Watermark Silver	\$89.00	
Vase.....	Antique, Antique Gold, Earth Rust, Watermark Silver	\$144.00	
STANDARD RODS (Available in 4' & 8' lengths)		4' - EACH	8' - EACH
1" Standard Rod (with Liner)	Antique, Antique Gold, Earth Rust, Watermark Silver	\$48.00	\$92.00
1.5" Standard Rod (with Liner)	Antique, Antique Gold, Earth Rust, Watermark Silver	\$49.00	\$94.00
TRAVERSE RODS (Available in 4' & 8' lengths)		4' - EACH	8' - EACH
1" Traverse Rod.....	Antique, Antique Gold, Earth Rust, Watermark Silver	\$124.00	\$184.00
1.5" Traverse Rod.....	Antique, Antique Gold, Earth Rust, Watermark Silver	\$140.00	\$226.00
1" Center Draw System	Antique, Antique Gold, Earth Rust, Watermark Silver	\$62.00	\$72.00
1.5" Center Draw System	Antique, Antique Gold, Earth Rust, Watermark Silver	\$84.00	\$122.00
1" One-Way Draw System.....	Antique, Antique Gold, Earth Rust, Watermark Silver	\$34.00	\$54.00
1.5" One-Way Draw System.....	Antique, Antique Gold, Earth Rust, Watermark Silver	\$60.00	\$100.00
BRACKETS		1" - EACH	1.5" - EACH
Standard Bracket.....	Antique, Antique Gold, Earth Rust, Watermark Silver	\$8.00	\$12.00
Extended Bracket	Antique, Antique Gold, Earth Rust, Watermark Silver	\$10.00	\$14.00
Traverse Bracket	Antique, Antique Gold, Earth Rust, Watermark Silver	\$26.00	\$32.00
Inside Mount.....	Antique, Antique Gold, Earth Rust, Watermark Silver	\$16.00	\$24.00
TIEBACKS			PAIR
Floral.....	Antique, Antique Gold, Earth Rust, Watermark Silver	\$58.00	
Radius	Antique, Antique Gold, Earth Rust, Watermark Silver	\$58.00	
Short Post - Male Tieback	Antique, Antique Gold, Earth Rust, Watermark Silver	\$12.00	
Short Post - Female Tieback	Antique, Antique Gold, Earth Rust, Watermark Silver	\$12.00	
ROSETTES			EACH
Floral	Antique, Antique Gold, Earth Rust, Watermark Silver	\$10.00	
Radius	Antique, Antique Gold, Earth Rust, Watermark Silver	\$10.00	
OTHER		1" - EACH	1.5" - EACH
Traverse Rod Connector	N/A.....	\$18.00	\$18.00
Corner Angle Connector	Antique, Antique Gold, Earth Rust, Watermark Silver	\$38.00	\$44.00
End Cap.....	Antique, Antique Gold, Earth Rust, Watermark Silver	\$12.00	\$18.00

ROBERT ALLEN DRAPERY HARDWARE
ARCHITRAVE COLLECTION *continued*

Description	Finishes	Wholesale
PACKAGE		
1.5" Ring	Antique, Antique Gold, Earth Rust, Watermark Silver	(10 Rings).....\$35.00
2" Ring	Antique, Antique Gold, Earth Rust, Watermark Silver	(10 Rings).....\$39.00
1" Traverse Rod Glides	N/A.....	(10 Glides).....\$6.00
1.5" Traverse Rod Glides	N/A.....	(10 Glides).....\$19.00
EACH		
Wand	Antique, Antique Gold, Earth Rust, Watermark Silver	\$46.00

- 1" brackets have a 3.5" projection. 1.5" brackets have a 3.75" projection.
- Brackets are sold separately for standard and traverse rods. 2 brackets are recommended for 4ft rods, 3 brackets are recommended for 8ft rods.

PREMIUM TRAVERSE SYSTEM FEATURES

- Hand-draw traverse rods available in 1" & 1.5" diameters, and 4' & 8' lengths. One-way draw and center draw traverse options available.
- Hand-draw traverse adds the utility of full drapery movement across the entire rod due to specially-designed top-mount brackets.
- 1" rod includes nylon glides; 1.5" rod includes roller glides with ball bearings.
- 1" traverse rod cannot be used with finials. Can only be utilized with end caps, inside mounts, or as a secondary rod in conjunction with the double bracket.
- One-way hand-draw traverse rod system includes 16 glides for 4' rods and 32 glides for 8' rods, one master carrier with arm and 2 end stops.
- One-way draw features reversible master carrier arm so draw can either be from the left side or the right side.
- Center draw traverse rod system includes 16 glides for 4' rods and 32 glides for 8' rods, pair of master carriers with overlap arm and standard arm, and 2 end stops. The master carrier arms (standard and overlap) are reversible that so that the overlap can be left over right or right over left.
- The use of a wand is strongly recommended for traverse rods.
- Use a splice to connect two traverse rods together.

Standard drapery rods are considered to be decorative drapery hardware, while traverse rod options provide both decorative and functional capabilities. While standard drapery rods are also functional, some collections are more appropriate for stationary treatments than others. This collection was designed to be special and unique for the designer to achieve a truly beautiful design statement, yet functional when the traverse rod option is selected. Standard drapery rods may be less appropriate for windows that require day-to-day functionality. Please contact Robert Allen Customer Service for further information.

**ROBERT ALLEN DRAPERY HARDWARE
BEDPOST COLLECTION**

Description	Finishes	Wholesale	
FINIALS		PAIR	
Bulb	Cherry, Country White, Mahogany, Pine, Walnut	\$82.00	
Globe	Cherry, Country White, Mahogany, Pine, Walnut	\$112.00	
Knob	Cherry, Country White, Mahogany, Pine, Walnut	\$92.00	
Pinecone Small.....	Cherry, Country White, Mahogany, Pine, Walnut	\$138.00	
Pinecone Large	Cherry, Country White, Mahogany, Pine, Walnut	\$142.00	
Top.....	Cherry, Country White, Mahogany, Pine, Walnut	\$89.00	
Urn.....	Cherry, Country White, Mahogany, Pine, Walnut	\$74.00	
RODS (Available in 4' & 8' lengths)		4' - EACH	8' - EACH
1.25" Plain Rod.....	Cherry, Country White, Mahogany, Pine, Walnut	\$70.00	\$105.00
1.75" Plain Rod.....	Cherry, Country White, Mahogany, Pine, Walnut	\$78.00	\$112.00
1.25" Twirl Rod	Cherry, Country White, Mahogany, Pine, Walnut	\$116.00	\$189.00
1.75" Twirl Rod	Cherry, Country White, Mahogany, Pine, Walnut	\$126.00	\$232.00
BRACKETS		1.25" - EACH	1.75" - EACH
Standard Bracket.....	Cherry, Country White, Mahogany, Pine, Walnut	\$24.00	\$24.00
Decorative Bracket	Cherry, Country White, Mahogany, Pine, Walnut	\$55.00	\$55.00
Extended Bracket	Cherry, Country White, Mahogany, Pine, Walnut	\$28.00	\$28.00
Inside Mount.....	Cherry, Country White, Mahogany, Pine, Walnut	\$32.00	\$34.00
TIEBACKS		PAIR	
Button	Cherry, Country White, Mahogany, Pine, Walnut	\$108.00	
OTHER		1.25" - EACH	1.75" - EACH
End Cap.....	Cherry, Country White, Mahogany, Pine, Walnut	\$25.00	\$26.00
		PACKAGE	
1.75" Rings for 1.25" Rods	Cherry, Country White, Mahogany, Pine, Walnut	(10 Rings)	\$58.00
2.25" Rings for 1.75" Rods	Cherry, Country White, Mahogany, Pine, Walnut	(10 Rings)	\$62.00

- Standard brackets have a 3.5" projection. Extended brackets have a 5.5" projection. Decorative bracket may be cut for extension between 4" and 9.25".
- Brackets are sold separately. 2 brackets are recommended for 4ft rods, 3 brackets are recommended for 8ft rods.

Standard drapery rods are considered to be decorative drapery hardware. While standard drapery rods are also functional, some collections are more appropriate for stationary treatments than others. Standard drapery rods may be less appropriate for windows that require day-to-day functionality. Please contact Robert Allen Customer Service for further information.

**ROBERT ALLEN DRAPERY HARDWARE
CASUAL ELEGANCE COLLECTION**

Description	Finishes	Wholesale		
FINIALS		1.5" - PAIR	2.25" - PAIR	
Artichoke.....	Antique Iron, Golden Patina, Silver Patina, Walnut.....	\$42.00.....	\$64.00	
Ball.....	Antique Iron, Golden Patina, Silver Patina, Walnut.....	\$42.00.....	\$64.00	
Crystal Ball	Golden Patina, Silver Patina	\$84.00.....	\$112.00	
Crystal Knob.....	Golden Patina, Silver Patina	\$80.00.....	\$158.00	
Medallion Knob.....	Antique Iron, Golden Patina, Silver Patina, Walnut.....	\$42.00.....	\$64.00	
Mirrored Glass.....	Golden Patina, Silver Patina	\$84.00.....	\$112.00	
Ring Finial.....	Antique Iron, Golden Patina, Silver Patina, Walnut.....	\$42.00.....	\$64.00	
STANDARD RODS (Available in 4', 6' & 8' lengths)		4' - EACH	6' - EACH	8' - EACH
1.5" Standard Rod	Antique Iron, Golden Patina, Silver Patina, Walnut.....	\$54.00.....	\$80.00.....	\$104.00
2.25" Standard Rod	Antique Iron, Golden Patina, Silver Patina, Walnut.....	\$116.00.....	\$164.00.....	\$209.00
.75" Secondary Rod	Antique Iron, Golden Patina, Silver Patina, Walnut.....	\$28.00.....	\$35.00.....	\$42.00
TRAVERSE RODS (Available in 4', 6' & 8' lengths)		4' - EACH	6' - EACH	8' - EACH
2.25" Traverse Rod.....	Antique Iron, Golden Patina, Silver Patina, Walnut.....	\$48.00	\$88.00.....	\$116.00
2.25" Single Track Hand-Draw System	Brown	\$39.00	\$56.00.....	\$68.00
2.25" Single Track Corded System.....	Brown	\$92.00	\$112.00.....	\$134.00
2.25" Single Track Hand-Draw C-Ring System	Brown	\$39.00	\$49.00.....	\$56.00
2.25" Single Track Corded C-Ring System	Brown	\$84.00	\$94.00.....	\$102.00
2.25" Double Track Hand-Draw System.....	Brown	\$78.00	\$112.00.....	\$136.00
2.25" Double Track Corded System	Brown	\$184.00	\$224.00.....	\$268.00
2.25" Double Track Hand-Draw C-Ring System....	Brown	\$78.00	\$98.00.....	\$112.00
2.25" Double Track Corded C-Ring System	Brown	\$168.00	\$188.00.....	\$204.00
BRACKETS		.75" - EACH	1.5" - EACH	2.25" - EACH
Standard Bracket.....	Antique Iron, Golden Patina, Silver Patina, Walnut	\$22.00	\$28.00	
Double Bracket.....	Antique Iron, Golden Patina, Silver Patina, Walnut	\$28.00	\$32.00	
Traverse Bracket	Brown	\$14.00		
Double Traverse Bracket.....	Brown	\$16.00		
Inside Mount.....	Antique Iron, Golden Patina, Silver Patina, Walnut.....	\$12.00.....	\$16.00	\$16.00
TIEBACKS		PAIR		
Holdback.....	Antique Iron, Golden Patina, Silver Patina, Walnut.....	\$32.00		
RINGS		PACKAGE		
1.5" Standard Rings	Antique Iron, Golden Patina, Silver Patina, Walnut	(10 Rings).....		\$38.00
2.25" Standard Rings	Antique Iron, Golden Patina, Silver Patina, Walnut	(10 Rings).....		\$52.00
.75" Secondary Rod Rings	Antique Iron, Golden Patina, Silver Patina, Walnut	(10 Rings).....		\$32.00
2.25" Traverse Rod C-Rings.....	Antique Iron, Golden Patina, Silver Patina, Walnut	(8 Rings).....		\$34.00

ROBERT ALLEN DRAPERY HARDWARE
CASUAL ELEGANCE COLLECTION *continued*

Description	Finishes	Wholesale		
OTHER		.75"- EACH	1.5"- EACH	2.25"- EACH
End Cap.....	Antique Iron, Golden Patina, Silver Patina, Walnut	\$12.00	\$12.00	\$12.00
Elbow Connector	Antique Iron, Golden Patina, Silver Patina, Walnut	\$38.00	\$42.00	\$50.00
				PAIR
.75" Secondary Rod End Cap	Antique Iron, Golden Patina, Silver Patina, Walnut			\$12.00
				EACH
Traverse Rod Connector	Antique Iron, Golden Patina, Silver Patina, Walnut			\$12.00
Wand	Antique Iron, Golden Patina, Silver Patina, Walnut.....			\$38.00

- 1.5" standard brackets have a 4" projection. 2.25" brackets have a 4.25" projection. 1.5" standard double brackets have a 5" projection for the front rod and a 2.5" projection for the back rod. 2.25" standard double brackets have a 5.5" projection for the front rod and a 2.5" for the back rod.
- Brackets are sold separately. 2 standard brackets are recommended for 4ft and 6ft rods, 3 standard brackets are recommended for 8ft rods.

PREMIUM TRAVERSE SYSTEM FEATURES

- Premium, single and double track, center-draw traverse rod systems are available in 4', 6' and 8' lengths.
- Heavy-duty aluminum tracks are of the highest quality.
- Superior strength performance. Maximum fabric weight: 6 pounds per foot.
- Tracks are powder-coated inside and out in a brown finish, and sealed with a factory-applied dry-lubricant. This patented finishing technique allows for smooth operation and effortless glide of drapery across the rod.
- Premium hand-draw traverse system includes aluminum track(s), Klick glides (14 with 4', 22 with 6' and 28 with 8'), left and right master carriers, and end stops.
- Premium corded traverse system includes aluminum track(s), Klick glides (14 with 4', 22 with 6' and 28 with 8'), left and right master carriers, right-side cord control with 6' cord drop, mounted cord pulley, and end stops.
- C-ring system includes same as other traverse systems except track is threaded with c-ring glides and master carriers.
- 2.25" Wood Traverse Rods, C-rings, Wands, and Brackets are sold separately.
- Single track brackets are 3" long with a 2.5" projection. The double track brackets are 6" long with 5.5" projection for the front track and 1.75" projection for the back track.
- 3 traverse brackets are recommended for 4ft and 6ft rods, 4 traverse brackets are recommended for 8ft rods.

Standard drapery rods are considered to be decorative drapery hardware, while traverse rod options provide both decorative and functional capabilities. While standard drapery rods are also functional, some collections are more appropriate for stationary treatments than others. This collection was designed to be special and unique for the designer to achieve a truly beautiful design statement, yet functional when the traverse rod option is selected. Standard drapery rods may be less appropriate for windows that require day-to-day functionality. Please contact Robert Allen Customer Service for further information.

**ROBERT ALLEN DRAPERY HARDWARE
CHESS COLLECTION**

Description	Finishes	Wholesale		
FINIALS		PAIR		
Castle	Driftwood, Mahogany	\$122.00		
Castle	Old World Gold, Watermark Silver	\$138.00		
King	Driftwood, Mahogany	\$122.00		
King	Old World Gold, Watermark Silver	\$138.00		
Knight	Driftwood, Mahogany	\$122.00		
Knight	Old World Gold, Watermark Silver	\$138.00		
Queen.....	Driftwood, Mahogany	\$122.00		
Queen.....	Old World Gold, Watermark Silver	\$138.00		
Rook	Driftwood, Mahogany	\$122.00		
Rook	Old World Gold, Watermark Silver	\$138.00		
TIEBACKS		PAIR		
King Holdback	Driftwood, Mahogany, Old World Gold, Watermark Silver	\$95.00		
STANDARD RODS (Available in 4', 6' & 8' lengths)		4' - EACH	6' - EACH	8' - EACH
2.25" Standard Rod	Driftwood, Mahogany	\$79.00	\$116.00	\$158.00
2.25" Standard Rod	Old World Gold, Watermark Silver	\$95.00	\$138.00	\$189.00
1.125" Secondary Rod	Antique Gold	\$28.00	\$42.00	\$55.00
TRAVERSE RODS (Available in 4', 6' & 8' lengths)		4' - EACH	6' - EACH	8' - EACH
2.25" Traverse Rod	Driftwood, Mahogany	\$54.00	\$76.00	\$105.00
2.25" Traverse Rod	Old World Gold, Watermark Silver	\$64.00	\$94.00	\$126.00
2.25" Single Track Hand-Draw System	Brown	\$39.00	\$56.00	\$68.00
2.25" Single Track Corded System.....	Brown	\$92.00	\$112.00	\$134.00
2.25" Single Track Hand-Draw C-Ring System.....	Brown	\$39.00	\$49.00	\$56.00
2.25" Single Track Corded C-Ring System	Brown	\$84.00	\$94.00	\$102.00
2.25" Double Track Hand-Draw System.....	Brown	\$78.00	\$112.00	\$136.00
2.25" Double Track Corded System	Brown	\$184.00	\$224.00	\$268.00
2.25" Double Track Hand-Draw C-Ring System....	Brown	\$78.00	\$98.00	\$112.00
2.25" Double Track Corded C-Ring System.....	Brown	\$168.00	\$188.00	\$204.00
BRACKETS		EACH		
Adjustable Bracket.....	Driftwood, Mahogany	\$46.00		
Adjustable Bracket.....	Old World Gold, Watermark Silver	\$54.00		
Adjustable Traverse Bracket.....	Driftwood, Mahogany	\$46.00		
Adjustable Traverse Bracket.....	Old World Gold, Watermark Silver	\$54.00		
Secondary Rod Bracket.....	Antique Gold	\$19.00		
Standard Traverse Bracket.....	Brown	\$14.00		
Double Traverse Bracket.....	Brown	\$16.00		
RINGS		PACKAGE		
2.25" Standard Rings	Driftwood, Mahogany	(10 Rings)	\$55.00	
2.25" Standard Rings	Old World Gold, Watermark Silver	(10 Rings)	\$64.00	
1.125" Secondary Rod Rings	Antique Gold	(7 Rings)	\$14.00	
2.75" C-Rings	Driftwood, Mahogany	(8 Rings)	\$38.00	
2.75" C-Rings	Old World Gold, Watermark Silver	(8 Rings)	\$42.00	

ROBERT ALLEN DRAPERY HARDWARE
CHESSE COLLECTION *continued*

Description	Finishes	Wholesale
OTHER		EACH
40"L Wand	Driftwood, Mahogany, Old World Gold, Watermark Silver	\$42.00
Elbow Connector	Driftwood, Mahogany	\$38.00
Elbow Connector	Old World Gold, Watermark Silver	\$40.00
1.875" Pawn End Cap	Driftwood, Mahogany, Old World Gold, Watermark Silver	\$24.00
		PAIR
1" Secondary Rod End Cap	Antique Gold	\$22.00

- Adjustable brackets have a 10.5" projection. Secondary Rod brackets have a 3.5" projection.
- Brackets are sold separately.

PREMIUM TRAVERSE SYSTEM FEATURES

- Premium, single and double track, center-draw traverse rod systems are available in 4', 6' and 8' lengths.
- Heavy-duty aluminum tracks are of the highest quality.
- Superior strength performance. Maximum fabric weight: 6 pounds per foot.
- Tracks are powder-coated inside and out in a brown finish, and sealed with a factory-applied dry-lubricant. This patented finishing technique allows for smooth operation and effortless glide of drapery across the rod.
- Premium hand-draw traverse system includes aluminum track(s), Klick glides (14 with 4', 22 with 6' and 28 with 8'), left and right master carriers, and end stops.
- Premium corded traverse system includes aluminum track(s), Klick glides (14 with 4', 22 with 6' and 28 with 8'), left and right master carriers, right side cord control with 6' cord drop, mounted cord pulley, and end stops.
- C-ring system includes same as other traverse systems except track is threaded with c-ring glides and master carriers.
- 2.25" Wood Traverse Rods, C-rings, Wands, and Brackets are sold separately.
- Single track brackets are 3" long with a 2.5" projection. The double track brackets are 6" long with 5.5" projection for the front track and 1.75" projection for the back track.
- 3 traverse brackets are recommended for 4ft and 6ft rods, 4 traverse brackets are recommended for 8ft rods.
- Adjustable Traverse Bracket is sold separately and is meant for decorative purposes only. The bracket projects 10.5" and can be cut down to preferred length.
- Brackets are sold separately for standard and traverse rods.

Standard drapery rods are considered to be decorative drapery hardware, while traverse rod options provide both decorative and functional capabilities. While standard drapery rods are also functional, some collections are more appropriate for stationary treatments than others. This collection was designed to be special and unique for the designer to achieve a truly beautiful design statement, yet functional when the traverse rod option is selected. Standard drapery rods may be less appropriate for windows that require day-to-day functionality. Please contact Robert Allen Customer Service for further information.

ROBERT ALLEN DRAPERY HARDWARE CLASSIC COLLECTION

Description	Finishes	Wholesale		
FINIALS				PAIR
Chester	Antique Walnut, Distressed Oak, Mahogany, Maple	\$74.00		
Dunlap	Antique Walnut, Distressed Oak, Mahogany, Maple	\$84.00		
Federal	Antique Walnut, Distressed Oak, Mahogany, Maple	\$102.00		
Newport	Antique Walnut, Distressed Oak, Mahogany, Maple	\$80.00		
Pembroke	Antique Walnut, Distressed Oak, Mahogany, Maple	\$74.00		
STANDARD RODS (Available in 4', 6' & 8' lengths)				
		4' - EACH	6' - EACH	8' - EACH
1.75" Standard Rod	Antique Walnut, Distressed Oak, Mahogany, Maple	\$76.00	\$112.00	\$146.00
BRACKETS				EACH
Standard Bracket	Antique Walnut, Distressed Oak, Mahogany, Maple	\$32.00		
Extended Bracket	Antique Walnut, Distressed Oak, Mahogany, Maple	\$38.00		
OTHER				PAIR
1.75" End Cap	Antique Walnut, Distressed Oak, Mahogany, Maple	\$42.00		
				PACKAGE
1.75" Ring	Antique Walnut, Distressed Oak, Mahogany, Maple	(10 Rings) \$52.00		
				EACH
40" L Wand	Antique Walnut, Distressed Oak, Mahogany, Maple	\$42.00		

• Brackets are sold separately. 2 brackets are recommended for 4ft and 6ft rods, 3 brackets are recommended for 8ft rods.

Standard drapery rods are considered to be decorative drapery hardware. While standard drapery rods are also functional, some collections are more appropriate for stationary treatments than others. Standard drapery rods may be less appropriate for windows that require day-to-day functionality. Please contact Robert Allen Customer Service for further information.

ROBERT ALLEN DRAPERY HARDWARE COSTUME COLLECTION

Description	Finishes	Wholesale	
FINIALS		PAIR	
Ball	Burnished Gold, Burnished Silver.....	\$139.00	
Basketweave	Burnished Gold, Burnished Silver.....	\$142.00	
Crystal	Burnished Gold, Burnished Silver.....	\$238.00	
Hatpin	Boudoir	\$155.00	
Hatpin	Burnished Gold, Burnished Silver.....	\$158.00	
Marble Egg	Burnished Gold.....	\$155.00	
Oval	Burnished Gold, Burnished Silver.....	\$158.00	
Spire	Burnished Gold, Burnished Silver.....	\$144.00	
RODS (Available in 4' & 8' lengths)		4' - EACH	8' - EACH
1.75" Reeded Rod	Burnished Gold, Burnished Silver.....	\$78.00	\$154.00
2.5" Reeded Rod	Burnished Gold, Burnished Silver.....	\$104.00	\$209.00
1" Secondary Rod	Burnished Gold, Burnished Silver.....	\$38.00	\$74.00
BRACKETS		1.75" - EACH	2.5" - EACH
Ormolu Standard Extension Bracket	Burnished Gold, Burnished Silver.....	\$25.00	\$25.00
Rope Standard Extension Bracket	Burnished Silver	\$25.00	\$25.00
Hanging Bracket		EACH	
Hanging Bracket		Burnished Gold, Burnished Silver..... \$6.00	
Inside Mount		1.75" - PAIR	2.5" - PAIR
Inside Mount		Burnished Gold, Burnished Silver.....	\$46.00 \$52.00
TIEBACKS		PAIR	
Ormolu	Burnished Gold, Burnished Silver.....	\$118.00	
Rope	Burnished Gold, Burnished Silver.....	\$118.00	
OTHER		EACH	
Finial Adapter	Burnished Gold, Burnished Silver.....	\$19.00	
Bracket Rosette	Burnished Gold, Burnished Silver.....	\$8.00	
Secondary Rod Connector	N/A.....	\$4.00	
End Caps		1.75" - EACH	2.5" - EACH
End Caps		Burnished Gold, Burnished Silver.....	\$28.00 \$32.00
Rings		1.75" - PKG	2.5" - PKG
Rings		Burnished Gold, Burnished Silver.....	\$72.00 \$74.00

- Standard brackets have a 3.5"-5.5" projection
- Brackets are sold separately. 2 brackets are recommended for 4ft rods, 3 brackets are recommended for 8ft rods.

Standard drapery rods are considered to be decorative drapery hardware. While standard drapery rods are also functional, some collections are more appropriate for stationary treatments than others. Standard drapery rods may be less appropriate for windows that require day-to-day functionality. Please contact Robert Allen Customer Service for further information.

ROBERT ALLEN DRAPERY HARDWARE COUNTRY IRON COLLECTION

Description	Finishes	Wholesale	
FINIALS		PAIR	
Knot	Antique, Black, Desert	\$84.00	
Loop.....	Antique, Black, Desert	\$72.00	
Scroll.....	Antique, Black, Desert	\$94.00	
Sphere	Antique, Black, Desert	\$45.00	
Spiral	Antique, Black, Desert	\$60.00	
Twist	Antique, Black, Desert	\$84.00	
RODS (Available in 4' & 8' lengths)		4' - EACH	8' - EACH
.75" Standard Rod	Antique, Black, Desert	\$39.00	\$78.00
.75" Secondary Rod	Antique, Black, Desert	\$39.00	\$78.00
BRACKETS		EACH	
Standard Bracket.....	Antique, Black, Desert	\$9.00	
Decorative Bracket	Antique, Black, Desert	\$39.00	
Hanger Bracket.....	Antique, Black, Desert	\$6.00	
Inside Mount		PAIR	
.....	Antique, Black, Desert	\$24.00	
TIEBACKS		PAIR	
Sphere.....	Antique, Black, Desert	\$30.00	
Twist	Antique, Black, Desert	\$98.00	
OTHER		PACKAGE	
1" Ring.....	Antique, Black, Desert	\$16.00	
1" Ring w/Clip	Antique, Black, Desert	\$22.00	
Connector		EACH	
.....	N/A.....	\$5.00	
End Cap.....	Antique, Black, Desert	\$12.00	

- Standard brackets have a 4.5" projection that extends to 6.5". Decorative brackets have a 3.5" projection.
- Brackets are sold separately. 2 brackets are recommended for 4ft rods, 3 brackets are recommended for 8ft rods.

Standard drapery rods are considered to be decorative drapery hardware, while traverse rod options provide both decorative and functional capabilities. While standard drapery rods are also functional, some collections are more appropriate for stationary treatments than others. This collection was designed to be special and unique for the designer to achieve a truly beautiful design statement, yet functional when the traverse rod option is selected. Standard drapery rods may be less appropriate for windows that require day-to-day functionality. Please contact Robert Allen Customer Service for further information.

**ROBERT ALLEN DRAPERY HARDWARE
FERRAFORTE COLLECTION**

Description	Finishes	Wholesale	
FINIALS		PAIR	
Academy.....	Antique Brass, Black, Earth Rust, Georgian Copper, Georgian Gold, Pewter.....	\$52.00	
Century.....	Antique Brass, Black, Earth Rust, Georgian Copper, Georgian Gold, Pewter.....	\$36.00	
Globe	Antique Brass, Black, Earth Rust, Pewter.....	\$70.00	
Helixa	Black, Earth Rust, Georgian Copper, Georgian Gold	\$98.00	
Jester.....	Black, Earth Rust, Georgian Copper, Georgian Gold	\$108.00	
Key	Antique Brass, Black, Earth Rust, Georgian Copper, Georgian Gold, Pewter.....	\$62.00	
Pinecone	Black, Earth Rust, Georgian Copper, Georgian Gold	\$45.00	
Scepter	Black, Earth Rust, Georgian Copper, Georgian Gold	\$45.00	
Spin	Antique Brass, Black, Earth Rust, Pewter.....	\$98.00	
STANDARD RODS (Available in 4' & 8' lengths)		4' - EACH	8' - EACH
1" Rod.....	Antique Brass, Black, Earth Rust, Georgian Copper, Georgian Gold, Pewter.....	\$40.00	\$79.00
TRAVERSE RODS (Available in 4' & 8' lengths)		4' - EACH	8' - EACH
1" Traverse Rod.....	Black, Earth Rust, Georgian Copper, Georgian Gold	\$124.00	\$184.00
1" Center Draw System.....	Black, Earth Rust, Georgian Copper, Georgian Gold	\$62.00	\$72.00
1" One-Way Draw System.....	Black, Earth Rust, Georgian Copper, Georgian Gold	\$34.00	\$54.00
BRACKETS		EACH	
Standard Bracket.....	Antique Brass, Black, Earth Rust, Georgian Copper, Georgian Gold, Pewter.....	\$8.00	
Extended Bracket 5.5".....	Antique Brass, Black, Earth Rust, Georgian Copper, Georgian Gold, Pewter.....	\$10.00	
Extended Bracket 8".....	Antique Brass, Black, Earth Rust, Georgian Copper, Georgian Gold, Pewter.....	\$14.00	
Top Mount Bracket For Traverse Rod.....	Black, Earth Rust, Georgian Copper, Georgian Gold	\$26.00	
		PAIR	
Inside Mount.....	Antique Brass, Black, Earth Rust, Georgian Copper, Georgian Gold, Pewter.....	\$16.00	
TIEBACKS		PAIR	
Pinecone.....	Black, Earth Rust, Georgian Copper, Georgian Gold	\$38.00	
Radius	Black, Earth Rust, Georgian Copper, Georgian Gold, Pewter	\$59.00	
		EACH	
Short Post/Female Tieback..	Antique Brass, Black, Earth Rust, Georgian Copper, Georgian Gold, Pewter.....	\$12.00	
ROSETTES		EACH	
1" Hammered	Antique Brass, Black, Earth Rust, Georgian Copper, Georgian Gold, Pewter.....	\$8.00	
2" Small	Antique Brass, Black, Earth Rust, Georgian Copper, Georgian Gold, Pewter.....	\$8.00	
2.5" Large.....	Antique Brass, Black, Earth Rust, Georgian Copper, Georgian Gold, Pewter.....	\$9.00	
OTHER		PACKAGE	
1.5" Ring.....	Antique Brass, Black, Earth Rust, Georgian Copper, Georgian Gold, Pewter.....	(10 Rings)	\$32.00
Glides	Black	(10 Glides)	\$6.00

ROBERT ALLEN DRAPERY HARDWARE
FERRAFORTE COLLECTION *continued*

Description	Finishes	Wholesale
1" Traverse Rod Connector .. N/A.....		<i>EACH</i> \$18.00
1" Corner Angle Connector	Antique Brass, Black, Earth Rust, Georgian Copper, Georgian Gold, Pewter	\$38.00
1" End Cap	Antique Brass, Black, Earth Rust, Georgian Copper, Georgian Gold, Pewter	\$12.00
Wand	Antique Brass, Black, Earth Rust, Georgian Copper, Georgian Gold, Pewter	\$46.00

- Standard brackets have a 3.5" projection. Extended brackets 5.5" have a 5.5" projection. Extended brackets 8" have a 8" projection.
- Brackets are sold separately for standard and traverse rods. 2 brackets are recommended for 4ft rods, 3 brackets are recommended for 8ft rods.

PREMIUM TRAVERSE SYSTEM FEATURES

- Hand-draw traverse rods available in 1" diameters, and in 4' & 8' lengths. One-way draw and center draw traverse options available.
- Hand-draw traverse adds the utility of full drapery movement across the entire rod due to specially-designed top-mount brackets.
- 1" rod includes nylon glides.
- One-way hand-draw traverse rod system includes 16 glides for 4' rods and 32 glides for 8' rods, one master carrier with arm and 2 end stops.
- One-way draw features reversible master carrier arm so draw can either be from the left side or the right side.
- Center draw traverse rod system includes 16 glides for 4' rods and 32 glides for 8' rods, pair of master carriers with overlap arm and standard arm, and 2 end stops. The master carrier arms (standard and overlap) are reversible that so that the overlap can be left over right or right over left.
- The use of a wand is strongly recommended for traverse rods.
- Use a splice to connect two traverse rods together.

Standard drapery rods are considered to be decorative drapery hardware, while traverse rod options provide both decorative and functional capabilities. While standard drapery rods are also functional, some collections are more appropriate for stationary treatments than others. This collection was designed to be special and unique for the designer to achieve a truly beautiful design statement, yet functional when the traverse rod option is selected. Standard drapery rods may be less appropriate for windows that require day-to-day functionality. Please contact Robert Allen Customer Service for further information.

**ROBERT ALLEN DRAPERY HARDWARE
FORGED COLLECTION**

Description	Finishes	Wholesale		
FINIALS		PAIR		
Ball.....	Black, Gunmetal, Patina, Rust	\$62.00		
Button End Cap	Black, Gunmetal, Patina, Rust	\$45.00		
Dart.....	Black, Gunmetal, Patina, Rust	\$62.00		
Floral End Cap.....	Black, Gunmetal, Patina, Rust	\$45.00		
Leaf.....	Black, Gunmetal, Patina, Rust	\$64.00		
Spear.....	Black, Gunmetal, Patina, Rust	\$62.00		
STANDARD RODS (Available in 4', 6' & 8' lengths)		4' - EACH	6' - EACH	8' - EACH
Standard Rod	Black, Gunmetal, Patina, Rust	\$42.00	\$64.00	\$84.00
BRACKETS		EACH		
Standard Bracket.....	Black, Gunmetal, Patina, Rust	\$18.00		
Extended Bracket Arm (Use With Standard Bracket).....	Black, Gunmetal, Patina, Rust.....	\$14.00		
Pass Through Bracket	Black, Gunmetal, Patina, Rust	\$38.00		
		PAIR		
Corner Bracket (Projects 7-9")	Black, Gunmetal, Patina, Rust	\$79.00		
Inside Mount.....	Black, Gunmetal, Patina, Rust	\$24.00		
RINGS		PACKAGE		
1.5" Rings.....	Black, Gunmetal, Patina, Rust	(10 Rings)..... \$42.00		
OTHER		EACH		
2.75" Elbow Connector.....	Black, Gunmetal, Patina, Rust	\$38.00		
40" L Wand.....	Black, Gunmetal, Patina, Rust	\$46.00		

• Brackets are sold separately. 2 brackets are recommended for 4ft and 6ft rods, 3 brackets are recommended for 8ft rods.

Standard drapery rods are considered to be decorative drapery hardware. While standard drapery rods are also functional, some collections are more appropriate for stationary treatments than others. Standard drapery rods may be less appropriate for windows that require day-to-day functionality. Please contact Robert Allen Customer Service for further information.

ROBERT ALLEN DRAPERY HARDWARE METROPOLITAN COLLECTION

Description	Finishes	Wholesale		
FINIALS				PAIR
Ball.....	Antique Silver, Black, Bronze, Chrome, Stainless Steel.....	\$38.00		
Lucent.....	Antique Silver, Black, Bronze, Chrome, Stainless Steel.....	\$38.00		
Metro	Antique Silver, Black, Bronze, Chrome, Stainless Steel.....	\$32.00		
RODS (Available in 4', 6' & 8' lengths)				
		4' - EACH	6' - EACH	8' - EACH
1.125" Standard Rod.....	Black, Bronze, Chrome, Stainless Steel.....	\$48.00	\$72.00	\$92.00
1.125" Traverse Rod.....	Antique Silver, Black, Bronze	\$42.00	\$64.00	\$84.00
BRACKETS				EACH
Standard Bracket.....	Black, Bronze, Chrome, Stainless Steel.....	\$18.00		
Extended Bracket.....	Black, Bronze, Chrome, Stainless Steel.....	\$25.00		
2" Bracket Extension Rod.....	Antique Silver, Black, Bronze, Chrome, Stainless Steel.....	\$8.00		
Inside Mount Bracket.....	Antique Silver, Black, Bronze, Chrome, Stainless Steel.....	\$22.00		
Traverse Standard Bracket.....	Antique Silver, Black, Bronze	\$9.00		
Traverse Extended Bracket.....	Antique Silver, Black, Bronze	\$10.00		
OTHER				PACKAGE
1.75" Rings.....	Black, Bronze, Chrome, Stainless Steel.....	(10 Rings)		\$32.00
Roller Glides.....	White	(16 pcs)		\$12.00
.75" End Cap.....	Antique Silver, Black, Bronze, Chrome, Stainless Steel	\$12.00		
				EACH
36" L Wand.....	Silver, Bronze	\$12.00		
Standard Rod Connector.....	n/a.....	\$9.00		
Traverse Connector.....	n/a.....	\$8.00		
Master Carrier With Overlap Arm .White		\$0.00		
Master Carrier With Straight Arm White		\$8.00		

- Brackets are sold separately for standard and traverse rods. 2 brackets are recommended for 4ft and 6ft rods, 3 brackets are recommended for 8ft rods.
- Choose either a 2" bracket projection or a 4" bracket projection. A 2" Extension Rod can be used in conjunction with a 4" bracket for a total of 6" of bracket projection.

PREMIUM TRAVERSE SYSTEM FEATURES

- One way hand-draw traverse rod systems are available in 1.125" diameter rods, and in 4', 6' and 8' lengths.
- Hand-draw traverse adds the utility of full drapery movement across the entire rod due to specially-designed rear-mount brackets.
- 1.125" traverse rod includes nylon glides. Roller glides are available separately for purchase for heavier treatments.
- One-way hand-draw traverse rod system includes 16 glides for 4' rods, 24 glides for 6' rods, and 32 glides for 8' rods, one master carrier with arm and 2 end stops.
- The master carrier with overlap arm is reversible that so that the draw can either be from the left side or the right side.
- The master carrier with straight arm is available separately for purchase to reconfigure the track for center draw operation.
- The use of a wand is strongly recommended for traverse rods.
- Use a splice to connect two traverse rods together.

Standard drapery rods are considered to be decorative drapery hardware, while traverse rod options provide both decorative and functional capabilities. While standard drapery rods are also functional, some collections are more appropriate for stationary treatments than others. This collection was designed to be special and unique for the designer to achieve a truly beautiful design statement, yet functional when the traverse rod option is selected. Standard drapery rods may be less appropriate for windows that require day-to-day functionality. Please contact Robert Allen Customer Service for further information.

**ROBERT ALLEN DRAPERY HARDWARE
PARISIAN COLLECTION**

Description	Finishes	Wholesale		
FINIALS		1.5" - PAIR	2.25" - PAIR	
Acanthus.....	Mahogany, Oak, Vintage Gold, Walnut	\$42.00.....	\$64.00	
Arbor.....	Mahogany, Oak, Vintage Gold, Walnut	\$42.00.....	\$64.00	
Chateau.....	Mahogany, Oak, Vintage Gold, Walnut	\$42.00.....	\$64.00	
Courtyard.....	Mahogany, Oak, Vintage Gold, Walnut	\$42.00.....	\$64.00	
Garland.....	Mahogany, Oak, Vintage Gold, Walnut	\$42.00.....	\$64.00	
Marquee	Mahogany, Oak, Vintage Gold, Walnut	\$49.00.....	\$70.00	
Trellis	Mahogany, Oak, Vintage Gold, Walnut	\$49.00.....	\$70.00	
RODS (Available in 4', 6' & 8' lengths)		4' - EACH	6' - EACH	8' - EACH
1.5" Standard Rod	Mahogany, Oak, Vintage Gold, Walnut	\$54.00.....	\$80.00.....	\$104.00
2.25" Standard Rod	Mahogany, Oak, Vintage Gold, Walnut	\$105.00.....	\$164.00.....	\$209.00
1.5" Fluted Rod.....	Mahogany, Oak, Vintage Gold, Walnut	\$64.00.....	\$92.00.....	\$112.00
2.25" Fluted Rod.....	Mahogany, Oak, Vintage Gold, Walnut	\$116.00.....	\$175.00.....	\$222.00
.75" Secondary Rod	Mahogany, Oak, Vintage Gold, Walnut	\$28.00.....	\$35.00.....	\$42.00
TRAVERSE RODS (Available in 4', 6' & 8' lengths)		4' - EACH	6' - EACH	8' - EACH
2.25" Standard Traverse Rod	Mahogany, Oak, Vintage Gold, Walnut	\$48.00.....	\$88.00.....	\$116.00
2.25" Fluted Traverse Rod.....	Mahogany, Oak, Vintage Gold, Walnut	\$48.00.....	\$88.00.....	\$116.00
2.25" Single Track Hand-Draw System	Brown	\$39.00.....	\$56.00.....	\$68.00
2.25" Single Track Corded System.....	Brown	\$92.00.....	\$112.00.....	\$134.00
2.25" Single Track Hand-Draw C-Ring System	Brown	\$39.00.....	\$49.00.....	\$56.00
2.25" Single Track Corded C-Ring System	Brown	\$84.00.....	\$94.00.....	\$102.00
2.25" Double Track Hand-Draw System.....	Brown	\$78.00.....	\$112.00.....	\$136.00
2.25" Double Track Corded System	Brown	\$184.00.....	\$224.00.....	\$268.00
2.25" Double Track Hand-Draw C-Ring System....	Brown	\$78.00.....	\$98.00.....	\$112.00
2.25" Double Track Corded C-Ring System	Brown	\$168.00.....	\$188.00.....	\$204.00
BRACKETS		.75" - EACH	1.5" - EACH	2.25" - EACH
Standard Bracket.....	Mahogany, Oak, Vintage Gold, Walnut	\$22.00.....	\$28.00	
Standard Double Bracket	Mahogany, Oak, Vintage Gold, Walnut	\$28.00.....	\$32.00	
Garland Bracket.....	Mahogany, Oak, Vintage Gold, Walnut	\$28.00.....	\$32.00	
Garland Double Bracket	Mahogany, Oak, Vintage Gold, Walnut	\$32.00.....	\$38.00	
Traverse Bracket	Brown.....		\$14.00	
Double Traverse Bracket.....	Brown		\$16.00	
Inside Mount.....	Mahogany, Oak, Vintage Gold, Walnut	\$16.00.....	\$16.00.....	\$16.00
TIEBACKS				PAIR
Acanthus	Mahogany, Oak, Vintage Gold, Walnut			\$46.00
Arbor.....	Mahogany, Oak, Vintage Gold, Walnut			\$46.00
OTHER				EACH
Standard Rod Connector.....	N/A			\$2.00
Traverse Rod Connector	N/A			\$12.00
Wand	Mahogany, Oak, Vintage Gold, Walnut			\$28.00

ROBERT ALLEN DRAPERY HARDWARE
PARISIAN COLLECTION *continued*

Description	Finishes	Wholesale		
		.75"- PKG	1.5"- PKG	2.25"- PKG
Standard Ring (10 Rings).....	Mahogany, Oak, Vintage Gold, Walnut		\$38.00.....	\$52.00
Standard C-Ring (8 Rings)	Mahogany, Oak, Vintage Gold, Walnut			\$34.00
Garland Ring (10 Rings).....	Mahogany, Oak, Vintage Gold, Walnut		\$42.00.....	\$59.00
Garland C-Ring (8 Rings).....	Mahogany, Oak, Vintage Gold, Walnut			\$34.00
Secondary Ring (10 Rings)	Mahogany, Oak, Vintage Gold, Walnut	\$32.00.....		
		.75"- PKG	1.5"- PKG	2.25"- PKG
Acanthus End Cap.....	Mahogany, Oak, Vintage Gold, Walnut		\$9.00.....	\$10.00
Elbow Connector	Mahogany, Oak, Vintage Gold, Walnut	\$38.00.....	\$42.00.....	\$50.00
				PAIR
.75" Secondary Rod End Cap	Mahogany, Oak, Vintage Gold, Walnut			\$12.00

- 1.5" standard brackets have a 3.625" projection. 2.25" brackets have a 4" projection. 1.5" standard double brackets have a 4.625" projection for the front rod and a 2.375" projection for the back rod.
- Brackets are sold separately. 2 standard brackets are recommended for 4ft and 6ft rods, 3 standard brackets are recommended for 8ft rods

PREMIUM TRAVERSE SYSTEM FEATURES

- Premium, single and double track, center-draw traverse rod systems are available in 4', 6' and 8' lengths.
- Heavy-duty aluminum tracks are of the highest quality.
- Superior strength performance. Maximum fabric weight: 6 pounds per foot.
- Tracks are powder-coated inside and out in a brown finish, and sealed with a factory-applied dry-lubricant. This patented finishing technique allows for smooth operation and effortless glide of drapery across the rod.
- Premium hand-draw traverse system includes aluminum track(s), Klick glides (14 with 4', 22 with 6' and 28 with 8'), left and right master carriers, and end stops.
- Premium corded traverse system includes aluminum track(s), Klick glides (14 with 4', 22 with 6' and 28 with 8'), left and right master carriers, right-side cord control with 6' cord drop, mounted cord pulley, and end stops.
- C-ring system includes same as other traverse systems except track is threaded with c-ring glides and master carriers.
- 2.25" Wood Traverse Rods, C-rings, Wands, and Brackets are sold separately.
- Single track brackets are 3" long with a 2.5" projection. The double track brackets are 6" long with 5.5" projection for the front track and 1.75" projection for the back track.
- 3 traverse brackets are recommended for 4ft and 6ft rods, 4 traverse brackets are recommended for 8ft rods.

Standard drapery rods are considered to be decorative drapery hardware, while traverse rod options provide both decorative and functional capabilities. While standard drapery rods are also functional, some collections are more appropriate for stationary treatments than others. This collection was designed to be special and unique for the designer to achieve a truly beautiful design statement, yet functional when the traverse rod option is selected. Standard drapery rods may be less appropriate for windows that require day-to-day functionality. Please contact Robert Allen Customer Service for further information.

**ROBERT ALLEN DRAPERY HARDWARE
POLYNESIAN COLLECTION**

Description	Finishes	Wholesale
FINIALS		PAIR
Abaca Rope	Rattan, Walnut	\$92.00
Abalone	Rattan, Walnut	\$116.00
Banana Leaf	Rattan, Walnut	\$92.00
Capiz Shell	Rattan, Walnut	\$116.00
Kapok	Rattan, Walnut	\$92.00
Penshell	Rattan, Walnut	\$116.00
Reeded	Rattan, Walnut	\$105.00
Tiki	Rattan, Walnut	\$92.00
Tropical	Rattan, Walnut	\$95.00

RODS (Available in 4', 6' & 8' lengths)		4' - EACH	6' - EACH	8' - EACH
1.75" Standard Rod	Rattan, Walnut	\$84.00	\$128.00	\$175.00
1.75" Fluted Rod	Rattan, Walnut	\$112.00	\$154.00	\$206.00
1.75" Reeded Rod	Rattan, Walnut	\$148.00	\$222.00	\$294.00

BRACKETS		EACH
3.75" Standard Bracket	Rattan, Walnut	\$32.00
6" Extended Bracket	Rattan, Walnut	\$39.00
3.75" Abaca Rope Bracket	Rattan, Walnut	\$42.00
3.75" Reeded Bracket	Rattan, Walnut	\$48.00
3.75" Tiki Bracket	Rattan, Walnut	\$32.00
3.75" Tropical Bracket	Rattan, Walnut	\$32.00

RINGS		PACKAGE
2.5" Standard Rings	Rattan, Walnut	(10 Rings)..... \$64.00
2.5" Fluted Rings	Rattan, Walnut	(10 Rings)..... \$70.00

• Brackets are sold separately. 2 brackets are recommended for 4ft and 6ft rods, 3 brackets are recommended for 8ft rods.

Standard drapery rods are considered to be decorative drapery hardware. While standard drapery rods are also functional, some collections are more appropriate for stationary treatments than others. Standard drapery rods may be less appropriate for windows that require day-to-day functionality. Please contact Robert Allen Customer Service for further information.

**ROBERT ALLEN DRAPERY HARDWARE
PROVENCE COLLECTION**

Description	Finishes	Wholesale	
FINIALS		PAIR	
Arabesque	Antique, Black Iron, Earth Rust, Golden Brass.....	\$66.00	
Arrow	Antique, Black Iron, Earth Rust, Golden Brass.....	\$62.00	
Ball	Antique, Black Iron, Earth Rust, Golden Brass.....	\$68.00	
Fern	Antique, Black Iron, Earth Rust, Golden Brass.....	\$62.00	
Fleur De Lys	Antique, Black Iron, Earth Rust, Golden Brass.....	\$62.00	
Harp	Antique, Black Iron, Earth Rust, Golden Brass.....	\$64.00	
RODS (Available in 4' & 8' lengths)		4' - EACH	8' - EACH
1" Standard Rod	Antique, Black Iron, Earth Rust, Golden Brass.....	\$38.00	\$75.00
1.5" Standard Rod	Antique, Black Iron, Earth Rust, Golden Brass.....	\$42.00	\$82.00
1" Secondary Rod	Antique, Black Iron, Earth Rust, Golden Brass.....	\$38.00	\$69.00
TRAVERSE RODS (Available in 4' & 8' lengths)		4' - EACH	8' - EACH
1" Traverse Rod	Antique, Black Iron, Earth Rust, Golden Brass.....	\$124.00	\$184.00
1.5" Traverse Rod	Antique, Black Iron, Earth Rust, Golden Brass.....	\$140.00	\$226.00
1" Center Draw System	Antique, Black Iron, Earth Rust, Golden Brass.....	\$62.00	\$72.00
1.5" Center Draw System	Antique, Black Iron, Earth Rust, Golden Brass.....	\$84.00	\$122.00
1" One-Way Draw System.....	Antique, Black Iron, Earth Rust, Golden Brass.....	\$34.00	\$54.00
1.5" One-Way Draw System.....	Antique, Black Iron, Earth Rust, Golden Brass.....	\$60.00	\$100.00
BRACKETS		1" - EACH	1.5" - EACH
Standard Bracket.....	Antique, Black Iron, Earth Rust, Golden Brass.....	\$22.00	\$24.00
Double Bracket.....	Antique, Black Iron, Earth Rust, Golden Brass.....	\$29.00	\$29.00
Extended Bracket.....	Antique, Black Iron, Earth Rust, Golden Brass.....	\$24.00	\$24.00
Traverse Bracket	Antique, Black Iron, Earth Rust, Golden Brass.....	\$26.00	\$32.00
Inside Mount.....		1" - PAIR	1.5" - PAIR
.....		\$18.00	\$20.00
TIEBACKS		PAIR	
Ball.....	Antique, Black Iron, Earth Rust, Golden Brass.....	\$52.00	
Curl.....	Antique, Black Iron, Earth Rust, Golden Brass.....	\$52.00	
OTHER		1" - EACH	1.5" - EACH
Standard Rod Connector.....	N/A.....	\$8.00	\$8.00
Traverse Rod Connector	N/A.....	\$18.00	\$18.00
Corner Angle Connector	Antique, Black Iron, Earth Rust, Golden Brass.....	\$38.00	\$44.00
End Cap.....	Antique, Black Iron, Earth Rust, Golden Brass.....	\$12.00	\$18.00

ROBERT ALLEN DRAPERY HARDWARE
PROVENCE COLLECTION *continued*

Description	Finishes	Wholesale
PACKAGE		
2" Rings	Antique, Black Iron, Earth Rust, Golden Brass.....	(10 Rings).....\$39.00
Small Glides	Black.....	(10 pcs).....\$6.00
Large Glides	Black.....	(10 pcs).....\$22.00
EACH		
40" L Wand	Antique, Black Iron, Earth Rust, Golden Brass.....	\$46.00

- 1" brackets have a 3.5" projection. 1.5" brackets have a 3.75" projection.
- Brackets are sold separately for standard and traverse rods. 2 brackets are recommended for 4ft rods, 3 brackets are recommended for 8ft rods.

PREMIUM TRAVERSE SYSTEM FEATURES

- Hand-draw traverse rods available in 4' and 8' lengths. One-way draw and center draw traverse options available.
- Hand-draw traverse adds the utility of full drapery movement across the entire rod due to specially-designed top-mount brackets.
- 1" rod includes nylon glides, 1.5" rod includes roller glides with ball bearings.
- 1" traverse rod cannot be used with finials. Can only be utilized with end caps, inside mounts, or as a secondary rod in conjunction with the double bracket.
- One-way hand-draw traverse rod system includes 16 glides for 4' rods and 32 glides for 8' rods, one master carrier with arm and 2 end stops.
- One-way draw features reversible master carrier arm so draw can either be from the left side or the right side.
- Center draw traverse rod system includes 16 glides for 4' rods and 32 glides for 8' rods, pair of master carriers with overlap arm and standard arm, and 2 end stops. The master carrier arms (standard and overlap) are reversible that so that the overlap can be left over right or right over left.
- The use of a wand is strongly recommended for traverse rods.
- Use a splice to connect two traverse rods together.

Standard drapery rods are considered to be decorative drapery hardware, while traverse rod options provide both decorative and functional capabilities. While standard drapery rods are also functional, some collections are more appropriate for stationary treatments than others. This collection was designed to be special and unique for the designer to achieve a truly beautiful design statement, yet functional when the traverse rod option is selected. Standard drapery rods may be less appropriate for windows that require day-to-day functionality. Please contact Robert Allen Customer Service for further information.

ROBERT ALLEN DRAPERY HARDWARE

TOSCANA COLLECTION

Description	Finishes	Wholesale	
FINIALS			
		1.5" - PAIR	2" - PAIR
Bella	Antique, Earth Rust, Italian Gold, Limestone, Sienna	\$94.00.....	
Campagna	Antique, Earth Rust, Italian Gold, Limestone, Sienna	\$110.00.....	
Firenze.....	Antique, Earth Rust, Italian Gold, Limestone, Sienna		\$104.00
Loggia.....	Antique, Earth Rust, Italian Gold, Limestone, Sienna		\$118.00
Piazza.....	Antique, Earth Rust, Italian Gold, Limestone, Sienna	\$88.00.....	
Saxon Small	Antique, Earth Rust, Italian Gold, Limestone, Sienna	\$94.00.....	
Saxon Large	Antique, Earth Rust, Italian Gold, Limestone, Sienna		\$105.00
TIEBACKS			
			PAIR
Floral.....	Antique, Earth Rust, Italian Gold, Limestone, Sienna		\$140.00
Rosette	Antique, Earth Rust, Italian Gold, Limestone, Sienna		\$92.00
RODS (Available in 4' & 8' lengths)			
		4' - EACH	8' - EACH
1.5" Plain Rod	Antique, Earth Rust, Italian Gold, Limestone, Sienna	\$60.00.....	\$125.00
2" Plain Rod	Antique, Earth Rust, Italian Gold, Limestone, Sienna	\$72.00.....	\$148.00
1.5" Rope Rod	Antique, Earth Rust, Italian Gold, Limestone, Sienna	\$168.00.....	\$368.00
2" Rope Rod	Antique, Earth Rust, Italian Gold, Limestone, Sienna	\$202.00.....	\$399.00
			EACH
Swing Arm w/Mounting Bracket.....	Antique, Earth Rust, Italian Gold, Limestone, Sienna		\$102.00
BRACKETS			
		1.5" - EACH	2" - EACH
Standard Bracket.....	Antique, Earth Rust, Italian Gold, Limestone, Sienna	\$29.00.....	\$30.00
Extended Bracket.....	Antique, Earth Rust, Italian Gold, Limestone, Sienna	\$32.00.....	\$32.00
Adapter	White		\$8.00
		1.5" - PAIR	2" - PAIR
Inside Mount.....	Antique, Earth Rust, Italian Gold, Limestone, Sienna	\$22.00.....	\$29.00
OTHER			
		1.5" - EACH	2" - EACH
Corner Angle.....	Antique, Earth Rust, Italian Gold, Limestone, Sienna	\$52.00.....	
End Cap.....	Antique, Earth Rust, Italian Gold, Limestone, Sienna	\$18.00.....	\$24.00
Standard Connector Rod.....	N/A.....	\$5.00.....	\$8.00
		2" - PKG	2.5" - PKG
Rings	Antique, Earth Rust, Italian Gold, Limestone, Sienna	\$46.00.....	\$58.00
		(10 Rings)	(10 Rings)
			EACH
40" L Wand	Antique, Earth Rust, Italian Gold, Limestone, Sienna		\$46.00

- 1.5" standard brackets have a 4.25" projection. 2" standard brackets have a 4.5" projection. 1.5" extended brackets have a 6" projection. 2" extended brackets have a 6.25" projection.
- Brackets are sold separately. 2 brackets are recommended for 4ft rods, 3 brackets are recommended for 8ft rods.

Standard drapery rods are considered to be decorative drapery hardware. While standard drapery rods are also functional, some collections are more appropriate for stationary treatments than others. Standard drapery rods may be less appropriate for windows that require day-to-day functionality. Please contact Robert Allen Customer Service for further information.

**ROBERT ALLEN DRAPERY HARDWARE
TRADITIONS COLLECTION**

Description	Finishes	Wholesale		
FINIALS				PAIR
Biltmore	Bronze, Ebony, Gilded, Platinum, Walnut w/Gold	\$92.00		
Hearst	Bronze, Ebony, Gilded, Platinum, Walnut w/Gold	\$105.00		
Monticello	Bronze, Ebony, Gilded, Platinum, Walnut w/Gold	\$100.00		
Vanderbilt.....	Bronze, Ebony, Gilded, Platinum, Walnut w/Gold	\$74.00		
Vernon	Bronze, Ebony, Gilded, Platinum, Walnut w/Gold	\$95.00		
Winterthur.....	Bronze, Ebony, Gilded, Platinum, Walnut w/Gold	\$95.00		
TIEBACKS				PAIR
Leaf Holdback.....	Bronze, Ebony, Gilded, Platinum, Walnut w/Gold	\$70.00		
Ribbed Holdback	Bronze, Ebony, Gilded, Platinum, Walnut w/Gold	\$70.00		
RODS (Available in 4', 6' & 8' lengths)				4' - EACH 6' - EACH 8' - EACH
2.25" Fluted Rod.....	Bronze, Ebony, Gilded, Platinum, Walnut Gold.....	\$112.00.....	\$164.00.....	\$218.00
BRACKETS				EACH
Standard Bracket.....	Bronze, Ebony, Gilded, Platinum, Walnut w/Gold	\$28.00		
Extended Bracket	Bronze, Ebony, Gilded, Platinum, Walnut w/Gold	\$32.00		
OTHER				PACKAGE
2.75" Rings	Bronze, Ebony, Gilded, Platinum, Walnut w/Gold	(10 rings)..... \$74.00		
1.875" End Cap	Bronze, Ebony, Gilded, Platinum, Walnut w/Gold	\$42.00		
36"L Wand	Bronze, Ebony, Gilded, Platinum, Walnut w/Gold	\$42.00		

• Brackets are sold separately. 2 brackets are recommended for 4ft rods, 3 brackets are recommended for 8ft rods.

Custom Finish Options - choose from one of 10 additional finishes that have been selected to complement the design aesthetic of this elegant collection (Silver w/Gold, Cappuccino, Soft Gold, Walnut w/Black, Flat Black w/Gold, Silver w/Black Wipe, Ivory w/Umber Rub, Venetian Gold, Bronze w/Copper, Statuary Bronze). An additional charge applies to these finishes and lead times vary from 2-4 weeks for shipment. Strike off samples will be provided for approval upon customer request.

Custom Finish Program - Send us a sample of your favorite finish and we will match it! You can also specify any Sherwin-Williams paint color and we can match that too! Additional charges apply for this service and will be quoted based on custom paint costs. Lead times vary from 3-6 weeks for shipment. Strike off samples will be provided for approval upon customer request.

Standard drapery rods are considered to be decorative drapery hardware. While standard drapery rods are also functional, some collections are more appropriate for stationary treatments than others. Standard drapery rods may be less appropriate for windows that require day-to-day functionality. Please contact Robert Allen Customer Service for further information.

USA

2 Hampshire Street
Suite 300
Foxboro, MA 02035
T 800.333.3777
F 800.332.8256

CANADA

2880 Argentia Road
Unit Eleven
Mississauga, ON L5N 7X8
T 800.363.3020
F 800.463.0339

UK

Chiltern House, The Valley Centre
Gordon Road,
High Wycombe, Buckinghamshire
HP13 6EQ England
T +44 (0) 1494.474741
F +44 (0) 1494.603400



USA 800.333.3777

CANADA 800.363.3020

EUROPE + 44 (0) 1494 474741

YOUR SEARCH ENDS HERE. RobertAllenDesign.com

**Duralee
Retail Price List
(Limited Stock items excluded)**

Prices effective - July 1, 2016

Book	Pattern	Weight	Width	Vertical Repeat	Horizontal Repeat	Content	Origin	Tariff1	Retail
5015	1157	15	57	7.06	7.5	56% COTTON 44% POLYESTER	U.S.A.	5211.43.0020	\$76.00
5015	1158	21	54	1.56	2.25	100% Cotton	U.S.A.	5906.90.1000	\$68.50
5015	1162	29	57	2.26	0	46% Cotton 36% Polyester17% Viscose 1% Nylon	U.S.A.	5903.90.2500	\$106.00
5015	1178	19	56	4.13	3.38	51% Cotton 31% Viscose 17% Polyester 1% Nylon	U.S.A.	5801.36.0010	\$89.00
5015	1181	19	57	15.25	15	41% Viscose 32% Cotton 27% Polyester	U.S.A.	5801.36.0010	\$103.50
5016	1192	30	55	27.75	27	70% Cotton 16% Viscose 14% Polyester	U.S.A.	5801.36.0010	\$95.50
5016	1208	26	53	6.25	6.75	84% Cotton 16% Polyester	U.S.A.	5903.90.3090	\$67.00
5011	1209	25	54	0	0	83% Cotton 17% Polyester	U.S.A.	5906.99.1000	\$61.50
5014	1215	9.6	54	6.75	0	100% COTTON	U.S.A.	5209.49.0000	\$110.50
5014	1216	9.2	54	0	0	100% COTTON	U.S.A.	5209.41.0000	\$110.50
5014	1218	9.2	54	0	0	100% COTTON	U.S.A.	5209.41.0000	\$109.00
5014	1220	11.7	54	0	0.88	64% COTTON 36% VISCOSE	U.S.A.	5211.49.0000	\$119.50
5014	1227	9.2	54	0.88	0.88	100% COTTON	U.S.A.	5209.41.0000	\$118.50
5014	1230	11.7	54	0	0	64% COTTON 36% VISCOSE	U.S.A.	5211.49.0000	\$119.50
5014	1231	11.7	54	0	0	64% COTTON 36% VISCOSE	U.S.A.	5211.49.0000	\$118.50
5015	1258	23	57	6	6.75	73% RAYON 18% POLYESTER 6% COTTON 2% FLAX 1% NYLON	U.S.A.	5516.23.0090	\$104.50
5016	1259	23	57	5.75	3.5	49% Cotton 37% Rayon 14%Polyester	U.S.A.	5516.43.0020	\$84.50
5012	1260	21	54	6.25	6.75	67% Cotton 33% Polyester	U.S.A.	5903.90.3090	\$98.00
5015	1262	15	55	1.63	1.75	45% Cotton 37% Rayon 18%Polyester	U.S.A.	5516.43.0020	\$102.50
5011	1264	27	55	1.56	4.5	85% Cotton 15% Polyester	U.S.A.	5903.90.3090	\$78.50
5012	1265	16	57	6.25	6.75	55% RAYON 45% COTTON	U.S.A.	5516.43.0020	\$108.50
5012	1266	13.1	54	11.58	6.75	36% POLYESTER 32% COTTON32% RAYON	U.S.A.	5407.93.1500	\$104.50
5016	1815	15.7	57	7	0	79% Cotton 21% Polyester	U.S.A.	5211.49.0020	\$64.00
5010	1958	21	56	2.5	0	83% Rayon 15% Polyester 2% Nylon	U.S.A.	5903.99.2500	\$77.00
1001	2149	8	54	30	27	55% LINEN 45% COTTON	U.S.A.		\$152.00
5013	6011	8.5	54	0	0	65% Cotton 35% Silk	India	5007.20.2500	\$135.50
2506	7229	0.2	0.25	0	0	71% Cotton 18% Acetate 7%Polyester 4% Acrylic	TURKEY	5808.90.0010	\$15.50
2506	7230	0.2	0.38	0	0	63% Cotton 30% Acetate 4%Polyester 3% Acrylic	TURKEY	5808.90.0010	\$21.00
2506	7231	0.2	3.25	0	0	66% Acetate 31% Acrylic 3% Nylon	TURKEY	6307.40.4020	\$57.50
2506	7232	0.3	1.5	0	0	76% Acrylic 16% Acetate 8% Polyester	TURKEY	5808.90.0010	\$33.50
2506	7233	0.4	3.25	0	0	56% Acetate 44% Acrylic	TURKEY	5808.90.0010	\$53.50
2506	7234	0.4	4.5	0	0	76% Acetate 24% Acrylic	TURKEY	6307.90.4020	\$107.00
2506	7235	0.4	3.5	0	0	77% Acrylic 12% Acetate 11% Metallic	TURKEY	5808.90.0010	\$163.00
2506	7236	0.3	2	0	0	51% Acrylic 33% Acetate 10% Polyester6% Nylon	TURKEY	5307.90.4020	\$77.00
2506	7237	0.9	8	0	0	55% Acetate 45% Acrylic	TURKEY	5808.90.0010	\$124.00
2506	7238	0.2	11.25	0	0	58% Acetate 19% Plastic 15% Acrylic 4% Cotton4% Polyester	TURKEY	5808.90.0010	\$69.00
2506	7239	0.7	32.25	0	0	46% Acetate 25% Plastic 20% Cotton 9% Acrylic	TURKEY	6307.90.4010	\$199.00
2506	7240	0.1	1.25	0	0	74% Acetate 26% Polyester	ITALY	5808.90.0010	\$24.50
2506	7241	0.2	2	0	0	73% Plastic 10% Metallic10% Acrylic 7% Polyester	TURKEY	6307.90.4020	\$78.00
2667	7242	0.1	2	0	0	100% Viscose	CHINA	5805.90.0000	\$18.00
2667	7243	0.5	0.75	0	0	100% Viscose	CHINA	5808.90.0000	\$14.50
2667	7244	0.1	0.25	0	0	65% Rayon 15% Polyester 20% Cotton	CHINA	5808.90.0000	\$20.00
2667	7245	0.1	0.25	0	0	62% Viscose 38% Cotton	CHINA	5808.90.0000	\$21.00
2667	7246	0.1	0.5	0	0	61% Rayon 26% Viscose 13% Cotton	CHINA	5808.90.0000	\$28.50
2667	7247	0.1	0.38	0	0	53% Rayon 47% Cotton	CHINA	5808.90.0090	\$19.00
2667	7248	0.1	0.5	0	0	44% Rayon 25% Viscose 24% Cotton 7% Nylon	CHINA	5808.90.0000	\$24.00
2667	7249	0.2	2.5	0	0	80% Rayon 20% Linen	INDIA	5808.10.7000	\$79.50
2667	7250	0.2	1.38	0	0	70% Rayon 30% Metal	INDIA	5808.90.0010	\$76.00
2667	7251	0.2	1.5	0	0	50% Wood 35% Viscose 15% Plastic	CHINA	5808.90.0010	\$54.00
2667	7252	0.4	1.5	0	0	85% Glass 15% Rayon	CHINA	5808.90.0010	\$55.00
2667	7253	0.3	3	0	0	60% Viscose 40% Rayon	CHINA	5808.90.0010	\$46.50
2667	7254	0.7	2	0	0	50% Rayon 50% Viscose	CHINA	5808.90.0010	\$46.50
2667	7255	0.2	1.5	0	0	100% Rayon	CHINA	5808.90.0010	\$21.00
2667	7256	0.1	38.5	0	0	68% Rayon 15% Wood 12% Viscose 5% Cotton	CHINA	5808.90.0010	\$37.00
2667	7257	0.2	31.5	0	0	50% Wood 25% Rayon 15% Viscose 10% Cotton	CHINA	5808.90.0010	\$70.50
2845	7278	0.1	9.75	0	0	60% Rayon 38% Viscose 2% Cotton	CHINA	5808.90.0090	\$40.00
2845	7279	0.9	34	0	0	42% Rayon 34% Viscose 24% Cotton	CHINA	5808.90.0090	\$153.00
2845	7280	0.2	2.5	0	0	54% Rayon 44% Viscose 2% Polyester	CHINA	5808.90.0090	\$54.00

**Duralee
Retail Price List
(Limited Stock items excluded)**

Prices effective - July 1, 2016

Book	Pattern	Weight	Width	Vertical Repeat	Horizontal Repeat	Content	Origin	Tariff1	Retail
2845	7281	0.2	2.25	0	0	63% Viscose 19% Rayon 18%Polyester	CHINA	5808.90.0090	\$58.00
2845	7282	0.1	2.25	0	0	67% Viscose 20% Rayon 13%Metallic	CHINA	5808.90.0090	\$27.00
2845	7283	0.5	0.63	0	0	63% Viscose 37% Rayon	CHINA	5808.90.0090	\$14.00
2845	7284	0.1	0.38	0	0	48% Cotton 22% Viscose 20% Rayon 10% Polyester	CHINA	5808.90.0090	\$16.50
2845	7285	0.2	0.5	0	0	60% Cotton 16% Rayon 14%Viscose 10% Polyester	CHINA	5808.90.0090	\$17.00
2845	7286	0.3	2.25	0	0	62% Viscose 38% Rayon	CHINA	5808.90.0090	\$40.50
2845	7287	0.1	1	0	0	54% Viscose 29% Rayon 11%Coconut6% Polyester	CHINA	5808.90.0090	\$30.50
2909	7289	3.7	3.25	0	0	66% Acetate 31% Acrylic 3% Nylon	TURKEY	5808.90.0010	\$57.50
2909	7290	0.3	2	0	0	51% Acrylic 32% Acetate 10% Polyester7% Nylon	TURKEY	5808.90.0010	\$79.00
2909	7291	0.2	1.75	0	0	77% Acrylic 10% Acetate 7% Metal4% Polyester 2% Nylon	TURKEY	5808.90.0010	\$80.00
2909	7292	0.4	3.5	0	0	77% Acrylic 11% Acetate 10% Metal 2% Other	TURKEY	5808.90.0010	\$163.00
2909	7293	0.2	0.25	0	0	71% Cotton 18% Acetate 7%Polyester 4% Other	TURKEY	5808.10.7000	\$16.00
2909	7294	0.2	0.38	0	0	60% Cotton 40% Acetate	TURKEY	5808.90.0010	\$22.00
2909	7295	0.2	0.5	0	0	57% Polyester 21% Acrylic17% Acetate5% Nylon	TURKEY	5808.90.0010	\$39.50
2909	7296	1.5	1.5	0	0	59% Polyester 41% Cotton	TURKEY	5808.90.0010	\$63.00
2909	7297	0.2	1			74% Acrylic 16% Acetate 8% Polyester2% Other	TURKEY	5808.90.0010	\$35.00
2909	7298	0.8	32.25	0	0	46% Acetate 21% Plastic 20% Cotton 8% Other5% Acrylic	TURKEY	5808.90.0010	\$180.00
2909	7299	0.2	11.25	0	0	57% Acetate 19% Plastic 15% Acrylic4% Polyester 1% Other 4% Cotton	TURKEY	5808.90.0010	\$68.00
2909	7300	0.1	2	0	0	73% Viscose 27% Polyester	U.K.	5808.90.0000	\$47.00
2930	7301	0.1	0.25	0	0	80% Acrylic 20% Polypropylene	USA	5808.90.0090	\$14.70
2930	7302	0.1	0.38	0	0	80% Acrylic 20% Polypropylene	USA	5808.90.0090	\$16.00
2930	7303	0.2	1.5	0	0	100% Acrylic	usa	5808.90.0090	\$27.00
2930	7304	0.2	2	0	0	100% Acrylic	USA	5808.90.0090	\$31.20
2930	7305	0.1	0.25	0	0	80% Acrylic 20% Polypropylene	USA	5809.90.0090	\$15.20
2930	7306	0.1	0.38			80% Acrylic 20% Polypropylene	USA	5808.90.0090	\$17.00
2930	7307	0.2	1.5	0	0	80% Acrylic 20% Polypropylene	USA	5808.90.0000	\$29.00
2930	7308	0.2	2	0	0	100% Acrylic	USA	5808.90.0000	\$33.50
2930	7309	0.5	4	0	0	100% Acrylic	USA	5308.90.0090	\$35.00
2930	7310	0.3	5	0	0	80% Acrylic 20% Polypropylene	USA	5808.90.0090	\$120.00
2930	7311	0.5	4	0	0	100% Acrylic	USA	5808.90.0000	\$37.00
2930	7312	0.3	5	0	0	80% Acrylic 20% Polypropylene	USA	5808.90.0000	\$130.00
2930	7313	0.1	4	0	0	100% Acrylic	USA	5808.90.0090	\$96.00
2930	7314	0.1	4	0	0	100% Acrylic	USA	5808.90.0000	\$104.00
2981	7318	0.1	0.25	0	0	98% Acrylic 2% Polyester	UNITED KINGD	5808.90.0000	\$25.00
2981	7319	0.1	1.75	0	0	99% Acrylic 1% Polyester	UNITED KINGD	5808.90.0000	\$24.00
2981	7320	0.1	2.38	0	0	99% Acrylic 1% Polyester	UNITED KINGD	5808.90.0000	\$39.00
2981	7321	0.1		0	0	53% Acrylic 47% Plastic	UNITED KINGD	5808.90.0000	\$110.00
2981	7322	0.1	2	0	0	99% Acrylic 1% Polyester	UNITED KINGD	5808.90.0000	\$47.00
2981	7323	0.2	1	0	0	98% Acrylic 2% Polyester	USA	5808.9	\$19.50
3012	7324	0.2	0.38			50% Cotton 50% Polyester	INDIA	6310.90.9000	\$19.50
3012	7325	0.8	3.25			65% Acrylic 34% Polyester1% Cotton	INDIA	5805.90.9000	\$80.00
3012	7326	0.2	0.38			72% Cotton 28% Polyester	INDIA	6310.90.9000	\$13.00
3012	7327	0.2	2.13			56% Polyester 38% Cotton6% Wool	INDIA	6310.90.9000	\$52.00
3012	7328	0.4	2			74% Polyester 26% Cotton	INDIA	5809.90.9000	\$32.00
3012	7329	0.2	2			95% Polyester 5% Cotton	INDIA	5808.90.9000	\$25.00
3012	7330	0.3	1.38			60% Polyester 37% Cotton3% Nylon	INDIA	5808.90.9000	\$40.00
3012	7331	0.2	3.5			79% Polyester 21% Cotton	INDIA	5809.09.0000	\$45.50
3012	7332	0.3	2.88			79% Polyester 21% Cotton	INDIA	5809.09.0000	\$45.00
3012	7333	0.1	1.5	0	0	79% Polyester 21% Cotton	INDIA	580.909	\$45.50
2813	9100	17	54	0	0	100% Polyester	CHINA	5407.52.2060	\$48.00
2813	9101	12.1	54	0	2.38	100% Polyester	TAIWAN	5407.52.2060	\$48.00
2813	9102	11.7	54	0	0	100% Polyester	TAIWAN	5407.52.2060	\$48.00
2813	9103	12.1	54	0	0	100% Polyester	TAIWAN	5407.52.2060	\$48.00
2813	9104	12.4	54	0	0	100% Polyester	TAIWAN	5407.53.2060	\$48.00
2813	9105	11.6	54	0	0	100% Polyester	TAIWAN	5407.61.9925	\$48.00
2813	9106	13.6	54	0	0	100% Polyester	TAIWAN	5407.52.2060	\$48.00
2813	9107	12.3	54	0	0	100% Polyester	CHINA	5407.53.2060	\$48.00
2979	9117	7	54	0	0	100% Polyester	TAIWAN	5407.52.2020	\$32.50

**Duralee
Retail Price List
(Limited Stock items excluded)**

Prices effective - July 1, 2016

Book	Pattern	Weight	Width	Vertical Repeat	Horizontal Repeat	Content	Origin	Tariff1	Retail
2980	9118		9	54	0	0 100% Polyester	TAIWAN	5407.52.2060	\$32.50
2938	9165	26.9	54		4	2 87% Polyester 11% Cotton2% Nylon	SOUTH KOREA	5801.37.5010	\$120.00
2938	9166	17.6	54		6	0.75 87% Polyester 11% Cotton2% Nylon	SOUTH KOREA	5801.37.5010	\$120.00
2938	9167	17.6	54.5		6	2 87% Polyester 11% Cotton2% Nylon	SOUTH KOREA	5801.37.5010	\$120.00
2938	9168	17.6	54.5		6	0.38 87% Polyester 11% Cotton2% Acetate	SOUTH KOREA	5801.37.5010	\$120.00
2938	9169	17.6	54		2	0.75 87% Polyester 11% Cotton2% Nylon	SOUTH KOREA	5801.37.5010	\$120.00
2938	9170	26.9	55		2	2 87% Polyester 11% Cotton2% Nylon	SOUTH KOREA	5081.37.5010	\$120.00
2938	9171	17.6	54		2	3 87% Polyester 11% Cotton2% Nylon	SOUTH KOREA	5801.37.5010	\$120.00
2938	9172	26.9	54		6	2 87% Polyester 11% Cotton2% Nylon	SOUTH KOREA	5801.37.5010	\$120.00
2938	9173	17.6	54		2	1 87% Polyester 11% Cotton2% Nylon	SOUTH KOREA	5801.37.5010	\$120.00
2938	9174	17.6	54.75		0	1 87% Polyester 11% Cotton2% Nylon	SOUTH KOREA	5801.37.5010	\$120.00
2938	9175	19.4	54.25		4	2 92% Polyester 6% Olefin 2% Nylon	SOUTH KOREA	5801.33.0000	\$100.00
2938	9176	19.4	54.25		6	0.75 92% Polyester 6% Olefin 2% Nylon	SOUTH KOREA	5801.33.0000	\$100.00
2938	9177	19.4	54.75		6	2 92% Polyester 6% Olefin 2% Nylon	SOUTH KOREA	5801.33.0000	\$100.00
2938	9178	19.4	54.75		6	0.38 92% Polyester 6% Olefin 2% Nylon	SOUTH KOREA	5801.33.0000	\$100.00
2938	9179	19.4	54.25		2	0.75 92% Polyester 6% Olefin 2% Nylon	SOUTH KOREA	5801.33.0000	\$100.00
2938	9180	21.5	55		2	2 92% Polyester 6% Olefin 2% Nylon	SOUTH KOREA	5801.33.0000	\$100.00
2938	9181	19.4	54.25		2	3 92% Polyester 6% Olefin 2% Nylon	SOUTH KOREA	5801.33.0000	\$100.00
2938	9182	19.4	54.25		6	2 92% Polyester 6% Olefin 2% Nylon	SOUTH KOREA	5801.33.0000	\$100.00
2938	9183	19.4	54.25		2	1 92% Polyester 6% Olefin 2% Nylon	SOUTH KOREA	5801.33.0000	\$100.00
2938	9184	21.5	54.75		0	1 92% Polyester 6% Olefin 2% Nylon	SOUTH KOREA	5801.33.0000	\$100.00
2716	15278	13.2	56		0	0 88% Post Ind Rcl'd Polyester 12% Polyurethane	JAPAN	5603.14.9010	\$170.00
2743	15281	8.3	54	6.25		0 72% Rayon 28% Polyester	USA	5516.23.0090	\$115.00
2772	15283	8.3	54		7	0 81% Rayon 19% Polyester	USA	5516.23.0090	\$109.00
2770	15284	17.6	54	1.75		1.38 84% Cotton 16% Rayon	USA	5211-49-0020	\$107.50
2772	15285	11.8	54.5	1.75		0.25 74% Rayon 26% Polyester	USA	5516-23-0090	\$100.50
2770	15286	21.3	57.75	0.38		0.38 100% Cotton	USA	5209-49-0040	\$89.50
2772	15287	17.6	55.5	10.88		3.5 87% Cotton 13% Rayon	USA	5211-49-0020	\$95.50
2772	15288	17.1	55.5	13.88		13.88 69% Rayon 31% Polyester	USA	5516-23-0090	\$109.50
2772	15289	10.1	55.5	4.88		4.5 67% Cotton 33% Polyester	USA	5211-49-0020	\$116.00
2771	15290	11.8	52		0	0 78% Cotton 22% Rayon	USA	5211-49-0020	\$77.50
2772	15291	16.5	54	13.13		7 41% Cotton 33% Polyester26% Rayon	USA	5211-49-0020	\$90.00
2772	15298	15.7	54		6	3.25 50% Cotton 50% Polyester	CHILE	5211-41-0000	\$132.00
2772	15299	13.4	58.5		0	0 63% Polyester 37% Rayon	USA	5801.36.0010	\$71.00
2770	15300	10.4	56.75	19.75		14.25 58% Polyester 42% Cotton	USA	5407-83-0090	\$79.00
2771	15301	10.9	54	7.25		7 97% Cotton 3% Rayon	USA	5209.49.0000	\$127.00
2771	15302	11.7	54	6.75		3.38 57% Cotton 43% Rayon	USA	5211.49.0020	\$101.50
2772	15303	13.2	54	1.5		1.13 58% Rayon 42% Polyester	USA	5801.36.0010	\$91.50
2772	15304	19.8	54		0	0 48% Cotton 28% Polyester24% Rayon	USA	5801.36.0020	\$89.50
2771	15305	15	54	7.25		4.5 63% Rayon 37% Polyester	USA	5516.23.0000	\$133.50
2772	15306	15	54	8.5		1.63 55% Rayon 45% Polyester	USA	5516.23.0000	\$117.00
2744	15307	23	52	5.38		4.5 76% Rayon 24% Polyester	USA	5801.36.0010	\$119.50
2770	15308	18.1	54	1.88		2.25 43% Polyester 33% Rayon 24% Cotton	USA	5407.93.2090	\$125.00
2772	15309	14.5	54	0.25		0 46% Rayon 41% Polyester 13% Acrylic	USA	5516.23.0090	\$85.50
2770	15310	12.5	54	1.38		1.13 55% Rayon 45% Polyester	USA	5516.23.0090	\$85.50
2770	15311	16.1	54	0.75		0.5 36% Polyester 34% Polypropylene 30% Rayon	USA	5407.93.2090	\$87.50
2772	15313	32.9	54	16		14 67% Rayon 24% Polyester 9% Cotton	CHINA	5801.36.0020	\$97.00
2772	15314	35	54		0	0 75% Rayon 25% Cotton	INDIA	5801.36.0020	\$97.00
2772	15318	24.3	55		0	0 85% Rayon 13% Polyester 2% Nylon	USA	5516-23-0090	\$93.50
2771	15319	18.2	58	8.25		4.5 60% Cotton 22% Rayon 18%Polyester	USA	5211.49.0020	\$82.50
2772	15320	15.5	56.5	16		15 79% Rayon 21% Polyester	USA	5516-23-0090	\$111.00
2741	15321	22.1	58.5	10		7.38 80% Rayon 18% Polyester 2% Nylon	USA	5516-43-0020	\$110.00
2772	15322	15.7	56.5	4.63		5 74% Rayon 26% Polyester	USA	5516-23-0090	\$110.00
2772	15323	13.9	56	12.5		13 77% Cotton 23% Polyester	USA	5211-49-0020	\$112.00
2772	15324	25	55	7.38		7.5 76% Rayon 17% Polyester 7% Cotton	USA	5516-23-0090	\$115.00
2772	15325	24.2	56.25	12		7.13 70% Rayon 17% Polyester 13% Cotton	USA	5516-23-0090	\$118.50
2772	15326	13.6	55.5	2		2.5 48% Rayon 28% Cotton 24%Polyester	USA	5516-43-0020	\$95.50
2772	15327	19.8	55	1.5		0 67% Rayon 33% Polyester	USA	5801-36-0010	\$118.00

**Duralee
Retail Price List
(Limited Stock items excluded)**

Prices effective - July 1, 2016

Book	Pattern	Weight	Width	Vertical		Content	Origin	Tariff1	Retail
				Repeat	Repeat				
2744	15328	15.6	54	6.75	6.75	45% Post Ind Rclid Polyester 39% Acrylic16% Polyester	USA	5801-36-0000	\$120.50
2772	15329	11.9	54	0	0	38% Cotton 35% Post Ind Rclid Polyester22% Acrylic 5% Viscose	USA	5801-36-0000	\$79.00
2770	15330	16.4	54	13.5	13.38	62% Polyester 38% Acrylic	USA	5801-36-0000	\$128.00
2772	15331	14.9	54	0.5	0.5	57% Rayon 24% Post Ind Rclid Polyester 19% Cotton	USA	5906-99-1000	\$118.00
2771	15334	19.1	54	24.63	13.5	71% Rayon 29% Polyester	USA	5516.23.0090	\$117.50
2772	15335	14.2	54	9	9	54% Rayon 30% Post Ind Rclid Polyester16% Post Cons Rclid Polyester	USA	5515-11-0090	\$115.00
2771	15336	13.5	54	18.25	13.5	51% Rayon 25% Cotton 24%Polyester	USA	5516.93.0020	\$112.50
2772	15337	13.3	54	1.25	1.13	61% Cotton 39% Polyester	USA	5211-49-0020	\$113.00
2771	15338	20.8	53.5	11.68	3.38	80% Cotton 20% Polyester	USA	5801.26.0010	\$102.50
2771	15339	13.8	54.75	18	13.88	52% Rayon 48% Cotton	USA	5516-43-0020	\$106.50
2772	15340	15.1	54	17	27	30% Post Ind Rclid Polyester 27% Cotton27% Rayon 16% Post Cons Rclid Polyester	USA	5407-93-2090	\$112.00
2771	15341	15.8	56.5	13.88	0	59% Rayon 41% Polyester	USA	5516.23.0090	\$96.00
2772	15342	19.4	54.75	8.88	13.5	39% Polyester 38% Cotton23% Rayon	USA	5801.36.0010	\$83.00
2770	15344	17.4	54	4.5	2.25	36% Rayon 33% Cotton 31%Polyester	USA	5516-23-0090	\$100.50
2772	15346	12.2	54	0	6.75	50% Cotton 50% Polyester	CHILE	5211-41-0000	\$132.00
2776	15351	19.3	54	0	0.25	100% Acrylic	USA	5512.29.0090	\$140.00
2776	15352	19.2	54	0	4.5	100% Acrylic	USA	5512.29.0090	\$14.00
2776	15353	16.5	54	0	2.25	100% Acrylic	USA	5512.29.0090	\$113.00
2776	15354	16.8	54	0.63	0	100% Acrylic	USA	5512.29.0090	\$115.50
2776	15355	16.8	54	4.88	2.75	100% Acrylic	USA	5512.29.0090	\$115.50
2776	15356	8	54	7.13	0	100% Acrylic	USA	5903.90.0000	\$91.00
2776	15357	8.2	54	6.13	0	100% Acrylic	USA	5903.90.0000	\$107.50
2931	15358	8	54	0	0	100% Acrylic	USA	5512.29.0000	\$81.00
2776	15359	8	54	10.63	0	100% Acrylic	USA	5903.90.1600	\$104.00
2776	15360	7.5	54	6.75	0	100% Acrylic	USA	5903.90.1600	\$107.50
3002	15361	8.1	53	8.25	9	100% Polyester	CHINA	5810.92.9080	\$96.00
2793	15362	8.3	54	4.63	5.13	100% Cotton	PORTUGAL	5209.41.6040	\$70.00
2793	15363	10.9	54	7.25	6.75	100% Cotton	INDIA	5209.49.0090	\$147.30
2793	15364	23	54	7	7	100% Cotton	PAKISTAN	5209.49.0020	\$137.00
2793	15365	17.1	55.5	4.5	4.63	69% Rayon 31% Polyester	USA	5516-23-0090	\$112.50
2793	15366	17.3	55.75	6.88	14	69% Rayon 31% Polyester	USA	5516-23-0090	\$112.50
2792	15367	15.2	56	9.25	2.25	56% Rayon 44% Cotton	USA	5516-43-0020	\$112.50
2793	15368	30.1	54	26.5	27.13	68% Cotton 18% Polyester14% Acrylic	USA	5801-26-0010	\$108.00
2793	15369	18.4	54	1.75	1.75	100% Rayon	USA	5516.13.0000	\$125.00
2793	15370	19.8	54	2	1.13	100% Rayon	USA	5516.13.0000	\$130.50
2793	15371	12.4	54	8.88	13.5	54% Cotton 46% Rayon	USA	5211.49.0010	\$113.50
2792	15372	12.7	54	0	0	50% Polyester 50% Rayon	USA	5516.23.0000	\$110.50
2793	15373	12.3	54	1.5	1.5	55% Cotton 45% Rayon	USA	5211.49.0010	\$111.00
2793	15374	13.4	54	0	0	50% Cotton 50% Rayon	USA	5516.43.0010	\$113.50
2792	15375	19.1	54	0	0	77% Cotton 23% Polyester	USA	5801.27.5010	\$99.50
2793	15376	17.3	54.5	7.38	6.75	73% Cotton 27% Polyester	USA	5211-49-0020	\$134.50
2793	15377	15.4	54.5	13	13.63	57% Polyester 43% Cotton	USA	5407-83-0090	\$127.50
2792	15378	16.2	54.5	1.13	2.25	68% Cotton 32% Polyester	USA	5211-49-0020	\$136.00
2793	15379	16.4	54	10.25	9.13	81% Cotton 19% Polyester	USA	5211-49-0020	\$118.50
2793	15380	12.4	54	1.38	0.63	57% Polyester 32% Rayon 11% Cotton	USA	5903-90-3090	\$127.50
2793	15381	14	54	1.88	1.13	40% Polyester 26% Rayon 21% Acrylic 13% Cotton	USA	5407.93.2090	\$93.50
2793	15382	18	54	27	13.5	65% Polyester 35% Rayon	CHINA	5801-36-0020	\$122.50
2793	15383	20.5	54	8.25	13.5	60% Rayon 40% Polyester	CHINA	5801.36.0020	\$126.00
2793	15384	12.7	54	0	0	100% Polyester	INDIA	5906-99-2500	\$87.50
2793	15385	16.8	56	1.75	1.75	73% Rayon 27% Polyester	CHINA	5516-23-0090	\$103.50
2793	15386	12.9	54	0	0	100% Polyester	INDIA	5407-53-2060	\$105.00
2793	15387	15.2	56	3.5	1.75	72% Rayon 28% Polyester	CHINA	5801-36-0020	\$107.00
2793	15388	12.2	57	12.38	13.5	66% Rayon 34% Polyester	USA	5906.99.2500	\$94.50
2792	15389	14.7	55	0	0	63% Rayon 22% Polyester 15% Cotton	USA	5801-36-0010	\$84.50
2792	15390	20.8	56.75	4.63	9	100% Polyester	USA	5801-36-0010	\$116.50
2793	15391	18.6	54	2.25	7	50% Polyester 43% Acrylic7% Viscose	TURKEY	5801-26-0000	\$88.50
2793	15392	28	54	0	0	100% Polyester	TURKEY	5512-19-0090	\$91.50
2793	15393	8.4	58	18.5	19.5	100% Polyester	TURKEY	5512-19-0090	\$99.50

**Duralee
Retail Price List
(Limited Stock items excluded)**

Prices effective - July 1, 2016

Book	Pattern	Weight	Width	Vertical Repeat	Horizontal Repeat	Content	Origin	Tariff1	Retail
2793	15394	10.7	58	17.88	18.75	74% Cotton 26% Polyester	TURKEY	5210-39-8090	\$80.00
2793	15395	20.9	54	6.88	3.5	66% Cotton 34% Polyester	TURKEY	5801.27.5010	\$145.00
2965	15396	8.7	53	0	0	100% Polyester	INDIA	5407.53.2040	\$61.50
2793	15397	19.1	51	14	15.75	100% Cotton	INDIA	5801.91.0010	\$140.00
2793	15398	16.2	54	0	0	75% Linen 25% Cotton	INDIA	5311.00.3090	\$92.00
2793	15399	28.9	55	6.25	0	54% Rayon 25% Polyester 21% Cotton	CHINA	5801-36-0020	\$132.50
2817	15400	17.6	59	6.25	6	100% Polypropylene	ITALY	5407.73.2060	\$125.00
2817	15401	15.6	55	0	0	100% Acrylic	ITALY	5512.29.0090	\$121.50
2817	15402	12.2	55	0	5.38	100% Acrylic	ITALY	5903.20.2500	\$121.00
2817	15403	12.9	55	4	4	100% Acrylic	ITALY	5903.20.2500	\$130.50
2816	15406	22.6	54	10.13	1.75	100% Acrylic	USA	5512.29.0090	\$167.00
2817	15407	16.8	54	1.75	0.25	100% Acrylic	USA	5512.29.0090	\$111.00
2817	15408	23.7	54	14.25	14.38	100% Acrylic	USA	5512.29.0090	\$177.00
2817	15409	19.2	54	1.38	1.88	100% Acrylic	USA	5512.29.0090	\$132.00
2817	15410	23.3	54	29.63	28.88	100% Acrylic	USA	5512.29.0090	\$171.00
2817	15411	19.8	54	31	14.5	100% Acrylic	USA	5512.29.0090	\$139.00
2817	15412	20.3	54	9.25	0	100% Acrylic	USA	5512.29.0090	\$131.00
2817	15413	22.1	54	15.5	14.63	100% Acrylic	USA	5512.29.0090	\$159.50
2931	15414	12.2	54	0	0	58% Polyester 42% Acrylic	USA	5906.99.2500	\$90.50
2817	15415	13.8	54	13.75	13.75	51% Polyester 49% Acrylic	USA	5906-99-2500	\$124.00
2817	15416	16.1	54	2.63	2.88	57% Acrylic 43% Polyester	USA	5906-99-2500	\$125.00
2817	15419	12.7	54	2.5	1.75	57% Polyester 43% Acrylic	USA	5906-99-2500	\$111.50
2817	15420	15	54	4.75	4.75	57% Acrylic 43% Polyester	USA	5906-99-2500	\$150.50
2817	15423	14.7	54	6.5	7	53% Acrylic 47% Polyester	USA	5906-99-2500	\$108.50
2817	15424	14.2	54	0	0	100% Olefin	USA	5407-73-2060	\$116.00
2817	15425	17	54	8.88	8.88	100% Olefin	USA	5407.53.2060	\$119.50
2817	15426	18.6	54	7.5	8.75	100% Olefin	USA	5801.36.0020	\$144.00
2817	15427	17.6	54	24.13	13.38	100% Olefin	USA	5407-73-2060	\$117.00
2815	15428	14.2	54	2.88	4.5	100% Olefin	USA	5407-73-2060	\$104.50
2817	15429	12.5	54	0	9	100% Olefin	USA	5407.93.2060	\$91.50
2817	15430	13.6	54	0.5	0.75	100% Olefin	USA	5407.73.2060	\$95.00
2817	15431	16.7	54	13.25	13.38	100% Olefin	USA	5407.73.2060	\$117.50
2817	15432	15.4	54	17.75	14	100% Polyester	USA	5407.69.3000	\$132.50
2817	15433	16	54	7.5	0	100% Polyester	USA	5407.69.3000	\$121.00
2817	15434	16	54	8.75	1.13	100% Polyester	USA	5407.69.3000	\$140.50
2817	15435	12.2	54	0	9	100% Olefin	USA	5407.73.2060	\$96.00
2840	15438	22.1	55	7.88	7.13	59% Acrylic 23% Polyester18% Cotton	TURKEY	5801-36-0010	\$118.50
2840	15441	16.5	55	10	13.75	59% Acrylic 23% Polyester18% Cotton	TURKEY	5801.36.0010	\$117.00
2840	15442	13.1	54	0	8.88	100% Cotton	INDIA	5209.31.3000	\$103.00
2840	15443	16.8	55	2.75	2.5	51% Cotton 22% Viscose 18% Acrylic9% Polyester	ITALY	5211.49.0090	\$129.00
2840	15444	17	59	11	7.25	75% Cotton 25% Rayon	USA	5801-36-0010	\$101.50
2840	15445	18	56	1.63	2.25	81% Cotton 19% Rayon	USA	5211-49-0020	\$103.50
2840	15446	27.3	58.25	1.75	1.75	100% Cotton	USA	5906-99-1000	\$121.50
2840	15447	26.1	56.5	16.38	13.5	97% Cotton 3% Rayon	USA	5209-49-0040	\$121.50
2840	15448	19.1	54	0	0	63% Rayon 37% Polyester	USA	5801.36.0010	\$109.50
2840	15449	13.4	54.5	13.25	9	47% Cotton 29% Polyester24% Linen	USA	5211-49-0000	\$132.50
2840	15450	15.3	54	8.25	14.25	49% Acrylic 36% Polyester15% Rayon	USA	5515.21.0090	\$100.00
2840	15451	17.5	54	5	3.5	67% Rayon 32% Polyester 1% Nylon	USA	5516.23.0090	\$129.00
2840	15452	18.2	54	6.25	4.75	68% Rayon 31% Polyester 1% Nylon	USA	5516.23.0090	\$114.00
2840	15453	21.1	52	8.13	3.38	74% Acrylic 26% Polyester	USA	5515.21.0090	\$130.00
2840	15454	14.3	56	7.38	6.88	100% Polyester	CHINA	5407.93.2090	\$90.00
2840	15455	20.9	55.5	0	0	46% Rayon 31% Polyester 22% Cotton 1% Nylon	USA	5906.99.2500	\$90.50
2840	15456	25.3	55.75	8.75	0	84% Cotton 16% Polyester	USA	5906.99.1000	\$74.50
2840	15457	24.4	57	2.25	1.75	83% Cotton 17% Polyester	USA	5906.99.1000	\$99.00
2840	15458	30.3	58	7	14	54% Rayon 36% Cotton 10%Polyester	USA	5516-43-0020	\$133.50
2839	15459	22.9	59.25	15.88	14.13	75% Cotton 25% Polyester	USA	5211-49-0020	\$133.50
2840	15460	17.2	57.25	6.13	0	67% Cotton 22% Polyester11% Rayon	USA	5801-36-0010	\$85.00
2840	15461	33.4	56	21	13.5	88% Cotton 12% Polyester	USA	5906.99.1000	\$126.00

**Duralee
Retail Price List
(Limited Stock items excluded)**

Prices effective - July 1, 2016

Book	Pattern	Weight	Width	Vertical	Horizontal	Content	Origin	Tariff1	Retail
				Repeat	Repeat				
2840	15462	15.7	58.75	7.13		7.5 53% Polyester 47% Rayon	USA	5516-23-0090	\$96.00
2840	15463	18.2	58.25	1.63		3.63 44% Rayon 33% Cotton 23%Polyester	USA	5516-43-0020	\$126.00
2840	15464	13.8	53	2		6.75 36% Cotton 35% Polyester29% Rayon	USA	5211-49-0020	\$130.50
2840	15465	15.1	55	7.75		0 63% Cotton 21% Polyester10% Rayon 6% Linen	USA	5211.49.0020	\$121.50
2850	15466	26	54	7.25		6.75 49% Cotton 33% Viscose 18% Linen	TURKEY	5211-49-0020	\$89.00
2850	15467	26	54	15.13		13.75 49% Cotton 33% Viscose 18% Linen	TURKEY	5211-49-0020	\$89.00
2850	15468	26	54	6		4.5 49% Cotton 33% Viscose 18% Linen	TURKEY	5211-49-0020	\$89.00
2850	15469	8.9	54	0		4.75 49% Cotton 33% Viscose 18% Linen	TURKEY	5211-49-0020	\$89.00
2850	15470	26	54	9.5		13.75 49% Cotton 33% Viscose 18% Linen	TURKEY	5211-49-0020	\$89.00
2850	15471	26	54	0		0 49% Cotton 33% Viscose 18% Linen	TURKEY	5211-49-0020	\$89.00
2878	15472	28.6	54	6.25		4.75 62% Acrylic 27% Polyester11% Viscose	TURKEY	5801.36.0010	\$114.50
2878	15473	26	55	6.63		6.63 60% Rayon 40% Polyester	CHINA	5801.36.0010	\$100.00
2878	15474	24.3	54	8.88		6.75 56% Acrylic 23% Polyester21% Rayon	CHINA	5903.90.2500	\$79.50
2877	15475	18.8	54	14		14 100% Polyester	CHINA	5515.12.0090	\$68.00
2878	15476	15.2	55	6.25		4.63 53% Rayon 47% Cotton	USA	5516.43.0020	\$91.00
2878	15477	21.5	52	14.5		7 47% Cotton 29% Rayon 24%Polyester	USA	5516.43.0020	\$103.50
2878	15478	21.4	56	0		0 49% Rayon 47% Cotton 4% Polyester	USA	5801.36.0010	\$94.00
2878	15479	12.8	54.5	9		0 42% Polyester 32% Rayon 26% Cotton	USA	5407.93.2090	\$79.00
2877	15480	17.1	57	7		13.5 46% Rayon 40% Cotton 14%Flax	USA	5906.99.2500	\$97.50
2878	15481	15.6	55	13.88		13.5 45% Cotton 44% Rayon 11%Polyester	USA	5516.43.0020	\$110.00
2878	15482	17.8	58.5	5		4.5 76% Cotton 24% Rayon	USA	5211.49.0020	\$97.50
2878	15483	17.1	55	0		0 53% Acrylic 47% Polyester	TURKEY	5801-26-0000	\$74.50
2878	15484	8.5	54	6.75		0 47% Viscose 39% Polyester14% Acrylic	TURKEY	5801.36.0010	\$102.50
2878	15485	15.6	54	4.13		4.5 60% Rayon 40% Polyester	USA	5801.36.0010	\$99.50
2877	15486	15.6	54	5.25		6.75 60% Rayon 40% Polyester	USA	5516.23.0000	\$99.50
2878	15487	11	60	11.5		15 87% Polyester 13% Rayon	CHINA	5906.99.2500	\$106.00
2877	15488	13.7	54	0.75		0.5 59% Rayon 41% Polyester	USA	5516.23.0090	\$92.00
2878	15489	15.7	54	0		0 45% Rayon 36% Polyester 18% Acrylic 1% Nylon	USA	5516.23.0090	\$94.50
2877	15490	25.4	56	31		28 53% Rayon 47% Polyester	CHINA	5516.23.0090	\$91.00
2878	15491	19.3	58	2.25		4 67% Polyester 33% Rayon	CHINA	5407.93.2090	\$74.50
2877	15492	16.8	54	27.5		28 100% Polyester	CHINA	5801.36.0020	\$93.50
2878	15493	33.5	55	19.75		13.75 73% Rayon 27% Polyester	CHINA	5801.36.0020	\$97.00
2878	15494	26.7	58	7.38		6.75 74% Rayon 19% Polyester 5% Cotton 2% Flax	USA	5516.23.0090	\$114.50
2878	15495	18.2	59	7		5 81% Polyester 19% Cotton	USA	5515.12.0090	\$96.00
2878	15496	24.2	57	1.38		3.38 71% Rayon 15% Cotton 14%Polyester	USA	5516.43.0020	\$102.00
2878	15497	13.7	57	6.63		13.5 40% Rayon 36% Cotton 24%Polyester	USA	5516.43.0020	\$96.00
2878	15498	16	58.5	0		0 63% Rayon 26% Polyester10% Post Ind Rcl'd Polyester 1% Nylon	USA	5801.36.0010	\$89.00
2878	15499	12.2	54	11.75		3.5 50% Polyester 50% Rayon	USA	5516.23.0090	\$90.50
2876	15500	16.8	54	10.5		14 43% Polyester 30% Post Cons Rcl'd Polyester27% Post Ind Rcl'd Polyester	USA	5515.12.0090	\$128.50
2878	15501	8.9	54	0		9 56% Polyester 44% Cotton	INDIA	5407.83.0090	\$119.50
2880	15503	13.6	54	30.5		14 100% Bella-Dura(r) Polyolefin	USA	5407.73.2060	\$96.50
2880	15504	14.5	54	2		3 100% Bella-Dura(r) Polyolefin	USA	5407.73.2060	\$101.00
2880	15505	20.6	54	9		9.25 100% Bella-Dura(r) Polyolefin	USA	5407.73.2060	\$147.00
2880	15506	12.2	54	0		0 100% Bella-Dura(r) Polyolefin	USA	5407.73.2060	\$81.00
2880	15507	14.5	54	13.5		14.5 100% Bella-Dura(r) Polyolefin	USA	5407.73.2060	\$120.50
2880	15508	14.2	54	14.5		13.5 100% Bella-Dura(r) Polyolefin	USA	5407.73.2060	\$101.00
2880	15509	12.2	54	0		0 100% Bella-Dura(r) Polyolefin	USA	5407.73.2060	\$100.50
2880	15510	16.6	54	4.63		4.63 100% Bella-Dura(r) Polyolefin	USA	5407.73.2060	\$113.00
2931	15511	14.2	54	0		0 100% Bella-Dura	USA	5407.73.2060	\$101.00
2880	15512	12.2	54	0		9 100% Bella-Dura(r) Polyolefin	USA	5407.73.2060	\$87.50
2880	15513	19.6	54	0		0 100% Bella-Dura(r) Polyolefin	USA	5407.73.2060	\$77.50
2896	15516	28	54	0.38		0.38 100% Polyvinyl chloride	TAIWAN	5903.10.2090	\$66.00
2896	15517	28	54	0		0 100% Polyvinyl chloride	TAIWAN	5903.10.2090	\$58.00
2896	15518	29	54	0		0 100% Polyvinyl chloride	TAIWAN	5903.10.2090	\$74.50
2896	15519	38	54	21		20.5 100% Polyvinyl chloride	TAIWAN	5903.10.2090	\$84.00
2896	15520	33	54	0		0 100% Polyvinyl chloride	TAIWAN	5903.10.2090	\$85.50
2896	15521	18	54	0		0 100% Polyurethane	TAIWAN	5903.10.2090	\$121.50
2896	15522	38	54	1.25		1.25 100% Polyvinyl chloride	TAIWAN	5903.10.2090	\$85.50

**Duralee
Retail Price List
(Limited Stock items excluded)**

Prices effective - July 1, 2016

Book	Pattern	Weight	Width	Vertical Repeat	Horizontal Repeat	Content	Origin	Tariff1	Retail
2896	15523	28	54		0	0 100% Polyvinyl chloride	TAIWAN	5903.10.2090	\$56.50
2896	15524	28	54		0	0 100% Polyvinyl chloride	TAIWAN	5903.10.2090	\$63.50
2896	15525	25	54		0	0 100% Polyurethane	TAIWAN	5903.10.2090	\$122.50
2896	15526	36	54	0.63	0.75	100% Polyvinyl chloride	TAIWAN	5903.10.2090	\$84.50
2896	15527	28	54		0	0 100% Polyvinyl chloride	TAIWAN	5903.10.2090	\$63.50
2896	15528	36	54	10.13	10.75	100% Polyvinyl chloride	TAIWAN	5903.10.2090	\$85.50
2896	15529	36	54		0	0 100% Polyvinyl chloride	TAIWAN	5903.10.2090	\$80.50
2896	15530	35	54		0	0 100% Polyvinyl chloride	TAIWAN	5903.10.2090	\$84.00
2896	15531	28	54		0	0 100% Polyvinyl chloride	TAIWAN	3921.12.1950	\$58.00
2896	15532	19	54		0	0 60% Polyurethane 20% Cotton 20% Polyester	CHINA	5903.20.3090	\$97.00
2896	15533	18	54		0	0 65% Polyurethane 25% Polyester 10% Cotton	CHINA	5903.20.0000	\$91.00
2896	15534	22	54		0	0 65% Polyurethane 25% Polyester 10% Cotton	CHINA	5903.20.0000	\$103.50
2896	15535	26	54	1	1	70% Polyurethane 20% Polyester 10% Cotton	CHINA	5903.20.0000	\$91.00
2896	15536	20	54		0	0 77% Polyurethane 23% Polyester	SOUTH KOREA	5903.20.3090	\$120.50
2896	15537	19	54	4.5	2.75	60% Polyurethane 20% Cotton 20% Polyester	CHINA	5903.20.3090	\$92.50
2896	15538	23	54		0	4 55% Polyester 45% Polyurethane	SOUTH KOREA	5903.20.0000	\$114.00
2896	15539	19	54		0	0 60% Polyurethane 20% Cotton 20% Polyester	CHINA	5903.20.3090	\$97.00
2896	15541	30	54		0	0 81% Polyvinyl chloride 19% Polyester	COSTA RICA	3921.12.1950	\$83.00
2907	15542	23.6	54	12.63		0 52% Acrylic 31% Polyester 11% Cotton 6% Viscose	TURKEY	5801.36.0020	\$75.00
2907	15543	26.1	55		7	6.75 67% Viscose 33% Polyester	TURKEY	5801.36.0020	\$102.00
2907	15544	27.4	54	0.63		1 75% Polyester 25% Cotton	TURKEY	5514.30.3310	\$71.50
2907	15545	10.1	54	6.25		6 72% Rayon 28% Polyester	USA	5516.23.0090	\$105.00
2906	15546	5.2	54	6.75		2.5 100% Polyester	USA	5407.69.3000	\$98.00
2907	15547	8.3	54	6.25		0 72% Rayon 28% Polyester	USA	5516.23.0090	\$102.00
2907	15548	9	54	18		0 80% Rayon 19% Polyester 1% Silk	USA	5516.23.0090	\$110.00
2906	15549	18	55.5	10.88		3.5 87% Cotton 13% Rayon	USA	5211.49.0020	\$113.50
2907	15550	17.4	54	27		27 69% Rayon 31% Polyester	USA	5516.23.0090	\$94.50
2907	15551	18.5	54	8.63		4.5 69% Polyester 18% Cotton 13% Acrylic	USA	5801.36.0010	\$85.50
2906	15552	17.1	54		0	0 53% Acrylic 47% Polyester	TURKEY	5801.2600.000	\$74.50
2907	15553	28.2	60		0	0 57% Cotton 40% Rayon 3% Polyester	USA	5906.99.1000	\$81.00
2905	15554	13.1	54	6.88		6.75 56% Rayon 44% Polyester	USA	5516.23.0090	\$93.50
2907	15555	20.3	59	14.13		13.5 81% Rayon 18% Cotton 1% Nylon	USA	5516.43.0020	\$99.50
2907	15556	14	54	11.5		13.5 55% Rayon 45% Polyester	USA	5516.23.0000	\$86.00
2906	15557	16.2	54	8.5		6.75 61% Rayon 39% Polyester	USA	5516.92.0000	\$105.00
2907	15558	15.6	54	9		6.75 60% Rayon 40% Polyester	USA	5516.23.0000	\$113.00
2907	15559	14	58	2		1 82% Polyester 18% Rayon	CHINA	5407.93.2010	\$79.00
2907	15560	14.9	54	1.25		1.13 63% Acrylic 37% Polyester	USA	5515.21.0090	\$78.50
2907	15561	11.7	54	0.5		0.63 53% Rayon 47% Polyester	USA	5516.23.0090	\$74.50
2907	15562	15.2	54	8		6.75 63% Rayon 37% Polyester	USA	5516.23.0090	\$109.00
2906	15563	15.1	54	15		14.13 63% Rayon 37% Polyester	USA	5516.23.0090	\$102.00
2907	15564	20.6	54	9		7 100% Polyester	CHINA	5801.36.0020	\$86.00
2907	15565	15.5	55	13.5		13.75 55% Cotton 45% Polyester	INDIA	5211.49.0090	\$104.50
2907	15566	25.8	60	18.5		30 76% Rayon 24% Polyester	CHINA	5801.36.0020	\$106.50
2907	15567	36.3	57	12.25		14.25 59% Rayon 41% Polyester	CHINA	5801.36.0020	\$111.00
2907	15568	35	56	25		28 70% Polyester 21% Rayon 9% Linen	CHINA	5515.11.0090	\$111.00
2907	15569	21.3	56	0		0 69% Acrylic 31% Polyester	USA	5801.36.0010	\$82.50
2905	15570	11.4	57	14.13		13.5 51% Polyester 48% Rayon 1% Nylon	USA	5516.23.0090	\$93.50
2907	15571	14.5	54	13.5		12.25 45% Polyester 26% Acrylic 20% Post Cons Rclid Polyester 9% Rayon	USA	5906.99.2500	\$83.00
2907	15572	17.9	54	0.38		0.5 56% Polyester 44% Rayon	USA	5801.36.0000	\$94.50
2906	15573	15.8	56	15.25		13.5 57% Polyester 22% Cotton 21% Rayon	USA	5906.99.1000	\$94.50
2907	15574	15.9	54	19.25		13.5 31% Post Ind Rclid Polyester 26% Rayon 26% Cotton 17% Post Cons Rclid Polyester	USA	5906.99.1000	\$94.50
2907	15575	16.8	54	1.5		1.5 29% Polyester 29% Post Ind Rclid Polyester 26% Acrylic 16% Post Cons Rclid Polyester	USA	5801.36.0000	\$98.00
2907	15576	22.8	54	13.63		13.5 55% Cotton 30% Polyester 15% Acrylic	USA	5906.99.1000	\$107.00
2907	15577	9.6	54	2.25		1 64% Rayon 36% Polyester	USA	5906.99.2500	\$62.50
2907	15578	12.5	54	1		1 41% Polyester 24% Rayon 23% Post Ind Rclid Polyester 12% Post Cons Rclid Pol	USA	5407.83.0090	\$96.00
2904	15579	15.8	54	14.38		13.5 30% Post Ind Rclid Polyester 21% Cotton 20% Rayon 17% Post Cons Rclid Polyester 12% Polyest	USA	5906.99.1000	\$94.50
2910	15580	2.5			0	0 100% Leather - Aniline	ARGENTINA	4107.11.5000	\$27.50
2910	15581	2.5			0	0 100% Leather - Aniline	ARGENTINA	4107.11.5000	\$25.00

Duralee
Retail Price List
(Limited Stock items excluded)

Prices effective - July 1, 2016

Book	Pattern	Weight	Width	Vertical Repeat	Horizontal Repeat	Content	Origin	Tariff1	Retail
2910	15582	2		0	0	100% Leather - Protected	ITALY	4107.12.5000	\$21.00
2910	15584	2		0	0	100% Leather - Aniline	ARGENTINA	4107.11.5000	\$23.50
2910	15585	2.5		0	0	100% Leather - Semi Aniline	ITALY	4107.12.5000	\$25.50
2910	15586	2		0	0	100% Leather - Aniline	ITALY	4107.12.5000	\$29.00
2910	15588	2.5		0	0	100% Leather - Aniline	ITALY	4107.12.5000	\$27.00
2910	15589	2.5		0	0	100% Leather - Aniline	GERMANY	4107.921	\$42.00
2910	15591	2		0	0	100% Leather - Semi Aniline	ITALY	4107.12.5000	\$23.50
2910	15593	2		0	0	100% Leather - Aniline	ARGENTINA	4107.11.5000	\$25.00
2910	15594	2.5		0	0	100% Leather - Semi Aniline	MEXICO	4107.995	\$27.50
2910	15595	2.5		0	0	100% Leather - Aniline	ARGENTINA	4107.11.5000	\$22.00
2910	15596	2.8		0	0	100% Leather - Aniline	ITALY	4107.11.5000	\$37.00
2910	15597	2.8		0	0	100% Leather - Aniline	ITALY	4107.11.5000	\$40.00
2910	15598	3		15	12.75	100% Leather - Semi Aniline	ITALY	4107.11.5000	\$47.50
2910	15599	2		0	0	100% Leather - Semi Aniline	BRAZIL	4104.11.10.10	\$26.00
2910	15600	2.5		0	0	100% Leather - Protected	ITALY	4107.11.5000	\$44.00
2910	15601	3		0	0	100% Leather - Semi Aniline	ITALY	4107.11.5000	\$40.50
2910	15602	3.3		0	0	100% Leather - Protected	ITALY	4107.11.5000	\$31.50
2910	15603	2.7		0	0	100% Leather - Aniline	ITALY	4107.11.5000	\$33.50
2910	15604	2.7		0	0	100% Leather - Protected	GERMANY	4107.11.5000	\$29.50
2910	15605	2.7		0	0	100% Leather - Aniline	GERMANY	4107.11.5000	\$46.50
2910	15606	2.7		0	0	100% Leather - Aniline	ITALY	4107.11.5000	\$23.00
2910	15607	2.7		0	0	100% Leather - Aniline	ARGENTINA	4107.11.5000	\$28.50
2910	15608	2.5		0	0	100% Leather - Aniline	GERMANY	4107.921	\$40.00
2910	15609	2.8		0	0	100% Leather - Semi Aniline	ITALY	4107.11.5000	\$27.50
2910	15610	2		0	0	100% Leather - Semi Aniline	ITALY	4104.11.10.10	\$29.00
2910	15611	3.2		0	0	100% Leather - Aniline	ITALY	4107.11.5000	\$31.50
2910	15612	3		0	0	100% Leather - Protected	ITALY	4107.11.5000	\$35.00
2910	15614	2.7		0	0	100% Leather - Protected	ITALY	4107.11.5000	\$20.50
2910	15615	2.7		0	0	100% Leather - Nubuck	ITALY	4107.11.5000	\$23.00
2910	15616	2.7		0	0	100% Leather - Protected	BRAZIL	4107.11.5000	\$21.50
2910	15617	2.7		0	0	100% Leather - Aniline	ARGENTINA	4107.11.5000	\$23.00
2923	15619	19.1	54	0	0	79% Cotton 21% Polyester	USA	5801.27.5010	\$93.00
2936	15621	17.5	55	12	14	69% Viscose 31% Polyester	TURKEY	5516.23.0090	\$98.50
2936	15622	18.9	55	17	14	42% Viscose 30% Polyester28% Cotton	TURKEY	5516.23.0090	\$105.50
2936	15623	15.6	55	14	14	69% Viscose 31% Polyester	TURKEY	5516.23.0090	\$92.00
2935	15624	21.2	55	1	0.75	75% Cotton 25% Polyester	TURKEY	5211.49.0020	\$88.50
2936	15625	16.5	55	14	14	67% Viscose 33% Polyester	TURKEY	5516.23.0090	\$92.00
2936	15626	14.2	57	11	7	42% Viscose 30% Polyester28% Cotton	TURKEY	5516.43.0035	\$129.00
2936	15627	9	54	0	0	100% Cotton	INDIA	5209.49.0030	\$79.00
2936	15628	9.5	54	0	3.5	100% Cotton	INDIA	5209.41.3000	\$75.50
2935	15629	16.1	55	16.25	0	45% Acrylic 30% Wool 25%Polyester	ITALY	5515.22.1000	\$166.00
2936	15630	12.2	56.5	0.5	7	69% Cotton 31% Linen	INDIA	5212.24.6030	\$151.00
2936	15631	39	55	7	3.38	60% Rayon 40% Polyester	CHINA	5801.32.0000	\$132.00
2936	15632	26	55	11.5	7	60% Rayon 40% Polyester	CHINA	5903.90.2500	\$125.00
2936	15634	16.2	57	1.88	0.13	74% Cotton 26% Rayon	USA	5211.49.0020	\$113.00
2935	15635	16.7	54	0.25	7	100% Cotton	INDIA	5209.39.0080	\$119.00
2936	15636	35.8	54	12.25	14.25	93% Polyester 7% Rayon	CHINA	5801.36.0020	\$104.50
2936	15637	22.3	54	3.5	0.5	100% Polyester	CHINA	5407.93.2090	\$91.00
2936	15638	23.1	56	17.75	4.5	69% Cotton 19% Polyester8% Post Ind Rcid Polyester 4% Post Cons Rcid Polye	USA	5801.26.0010	\$105.50
2936	15639	23	56	8.75	3.5	52% Polyester 48% Cotton	USA	5801.36.0010	\$95.50
2936	15640	27.2	58	6.13	7.25	72% Rayon 17% Cotton 11%Polyester	USA	5516.43.0020	\$118.50
2935	15641	19.1	57	0	0	33% Rayon 27% Bamboo 21%Polyester 3% Other16% Cotton	USA	5801.90.1000	\$99.50
2936	15642	15.6	58	5	9.75	100% Polyester	USA	5515.12.0090	\$119.50
2938	15644	17.6	54.75	0	0	82% Polyester 18% Cotton	SOUTH KOREA	5801.37.5010	\$80.50
2938	15645	19.4	55	0	0	100% Polyester	SOUTH KOREA	5801.33.0000	\$60.50
2931	15646	8	54	0	0	100% Acrylic	USA	5512.29.0000	\$81.00
2936	15648	18.4	57.5	7	4.5	100% Cotton	USA	5209.49.0040	\$110.00
2964	15649	16.6	54	11.88	6.63	73% Viscose 19% Cotton 8%Polyester	INDIA	5516430000	\$120.50

**Duralee
Retail Price List
(Limited Stock items excluded)**

Prices effective - July 1, 2016

Book	Pattern	Weight	Width	Vertical Repeat	Horizontal Repeat	Content	Origin	Tariff1	Retail
2961	15650	18.6	54	2.25		7 49% Polyester 44% Acrylic7% Viscose	TURKEY	5801360000	\$88.50
2963	15651	27	54	8		4.5 70% Viscose 30% Polyester	TURKEY	5801360000	\$109.50
2964	15652	18.5	54	2.63		7 74% Polyester 26% Cotton	TURKEY	5047309000	\$86.50
2964	15653	19.5	55	13		14 90% Viscose 10% Polyester	TURKEY	5516139000	\$125.50
2964	15654	12.6	55	7		13.88 45% Viscose 30% Cotton 25% Polyester	INDIA	5513419000	\$118.50
2964	15655	12.4	55	13.38		13.75 70% Cotton 30% Viscose	INDIA	5211490000	\$126.50
2964	15656	12.8	55	0		0 54% Polyester 46% Rayon	CHINA	5515119000	\$91.00
2964	15657	20.9	54	6.88		3.5 60% Cotton 40% Polyester	TURKEY	5801270000	\$145.00
2965	15658	8.7	53	0		0 100% Polyester	INDIA	5047530023	\$61.50
2963	15659	20	54	0		0 55% Polyester 38% Acrylic7% Viscose	TURKEY	5801360000	\$90.50
2964	15660	26.3	54	19.5		14.13 50% Polyester 42% Acrylic8% Viscose	TURKEY	5801360000	\$104.50
2963	15661	10.1	51	14		15.75 100% Cotton	INDIA	5810910000	\$140.00
2964	15662	12.7	56	1.75		2.25 53% Cotton 47% Rayon	USA	5211490000	\$104.00
2964	15663	11.5	56.5	6.75		7 68% Rayon 27% Polyester 5% Flax	USA	5516239900	\$123.00
2964	15664	22.7	58.75	11.5		9.75 100% Polyester	USA	5515129000	\$109.50
2963	15665	11.5	54	43.75		26.75 100% Polyester	INDIA	5407739000	\$115.00
2964	15666	13.6	54	13.38		6.38 57% Viscose 29% Polyester14% Acrylic	INDIA	5408330000	\$126.00
2961	15667	20.5	54	8.25		13.5 60% Rayon 40% Polyester	CHINA	5801360000	\$126.00
2964	15668	32	56	5.25		1.25 70% Rayon 30% Polyester	CHINA	5801360000	\$120.50
2963	15669	25.4	57.5	21.5		28.75 72% Rayon 28% Polyester	CHINA	5516239900	\$100.50
2964	15670	28.9	54	6.25		0 58% Rayon 21% Cotton 21%Polyester	CHINA	5801360000	\$132.50
2964	15671	10	54	21.38		27.5 62% Polyester 38% Viscose	INDIA	5407939000	\$100.50
2964	15672	25.4	56	3.5		1.75 75% Rayon 25% Polyester	CHINA	5801360000	\$107.00
2963	15673	13.8	55.5	17.5		27.5 55% Rayon 23% Polyester 22% Cotton	USA	5516430000	\$110.50
2964	15674	14.4	58	14.13		14.5 71% Rayon 29% Polyester	USA	5516239900	\$125.00
2963	15675	16.9	56	11.25		3.5 81% Rayon 19% Polyester	USA	5801360000	\$92.50
2964	15676	17.3	58	17.5		14.5 76% Rayon 24% Polyester	USA	5516239900	\$125.00
2964	15677	17	57	16.88		0.25 42% Rayon 34% Cotton 24%Polyester	USA	5801360000	\$86.00
2964	15678	20.7	59	20.38		14.88 98% Polyester 2% Rayon	USA	5515129000	\$125.00
2961	15679	12.3	53.5	19.25		13.5 57% Polyester 43% Rayon	USA	5407939000	\$102.50
2983	15683	9.9	54	0		0 100% Polyester	USA	5516.13.0000	\$103.00
2983	15684	8.5	54	7.75		0 100% Polyester	USA	5516.13.0000	\$96.00
2983	15685	8.5	54	7.75		0 100% Polyester	USA	5516.13.0000	\$96.00
2983	15686	22.2	57	0		0 100% Polyolefine	BELGIUM	5407.53.2060	\$113.50
2983	15687	15.8	54	8.13		9 100% Acrylic	USA	5512.29.0000	\$148.00
2983	15688	19.1	54	6.63		3.38 100% Acrylic	USA	5512.29.0000	\$162.00
2983	15689	15.8	54	8.13		9 100% Acrylic	USA	5512.29.0000	\$162.00
2983	15690	20.6	54	15		13.25 100% Acrylic	USA	5512.29.0090	\$149.00
2983	15691	21.4	54	16.88		28.38 100% Acrylic	USA	5512.29.0090	\$168.00
2983	15692	23.7	54	15.75		14.13 100% Acrylic	USA	5512.29.0090	\$180.50
2983	15693	13	56	26.25		0 100% Bella-Dura(r) Polyolefin	USA	5407.73.2060	\$97.50
2983	15694	18.7	53	14		26.75 100% Bella-Dura(r) Polyolefin	USA	5407.73.2060	\$147.00
2983	15695	15.9	54	5.13		7 100% Bella-Dura(r) Polyolefin	USA	5407.73.2060	\$120.50
2983	15696	17.5	54	12		13.75 100% Bella-Dura(r) Polyolefin	USA	5407.73.2060	\$141.00
2983	15697	15.6	54	2.5		0.38 100% Bella-Dura(r) Polyolefin	USA	5407.73.2060	\$118.00
2983	15698	17	54	13.5		13.75 100% Bella-Dura(r) Polyolefin	USA	5407.73.2060	\$133.00
2983	15699	18.8	54	3.5		3.38 100% Bella-Dura(r) Polyolefin	USA	5407.73.2060	\$146.00
2983	15700	17	54	3.63		1.75 100% Bella-Dura(r) Polyolefin	USA	5407.73.2060	\$132.00
2983	15701	17.5	54	12		13.5 100% Bella-Dura(r) Polyolefin	USA	5407.73.2060	\$146.00
2983	15702	16.7	54	12.75		6.88 100% Bella-Dura(r) Polyolefin	USA	5407.73.2060	\$127.50
2983	15703	14.7	54	6.38		1.88 100% Bella-Dura(r) Polyolefin	USA	5407.73.2060	\$111.00
2983	15704	15.3	54	13.25		7 100% Bella-Dura(r) Polyolefin	USA	5407.73.2060	\$124.00
2983	15705	16.7	54	12.75		6.88 100% Bella-Dura(r) Polyolefin	USA	5407.73.2060	\$127.50
2983	15706	17.5	54	12		13.5 100% Bella-Dura(r) Polyolefin	USA	5407.73.2060	\$145.00
2998	15707	10.4	54	0		0 100% Bella-Dura(r) Polyolefin	USA	5407.73.2060	\$78.00
2998	15708	16.6	54	4.63		4.63 100% Bella-Dura(r) Polyolefin	USA	5407.73.2060	\$110.50
2998	15709	12.2	54	0		0 100% Bella-Dura(r) Polyolefin	USA	5407.73.2060	\$91.00
2998	15710	12.7	54	0		0 100% Bella-Dura(r) Polyolefin	USA	5407.73.2060	\$91.00

**Duralee
Retail Price List
(Limited Stock items excluded)**

Prices effective - July 1, 2016

Book	Pattern	Weight	Width	Vertical	Horizontal	Content	Origin	Tariff1	Retail
				Repeat	Repeat				
2998	15711	12.2	54		0	9 100% Bella-Dura(r) Polyolefin	USA	5407.73.2060	\$84.50
2998	15712	14.2	54	6.25		14 100% Bella-Dura(r) Polyolefin	USA	5407.73.2060	\$104.00
2998	15713	16.5	54	0.5		4.75 100% Bella-Dura(r) Polyolefin	USA	5407.73.2060	\$117.00
2998	15714	13.9	54	3.38		6.75 100% Bella-Dura(r) Polyolefin	USA	5407.73.2060	\$97.50
2998	15715	18.4	54	20.88		13.5 100% Bella-Dura(r) Polyolefin	USA	5407.73.2060	\$136.50
2998	15716	12.7	54	13.88		0 100% Bella-Dura(r) Polyolefin	USA	5407.73.2060	\$91.00
2998	15717	13.3	54	7.75		0 100% Bella-Dura(r) Polyolefin	USA	5407.73.2060	\$91.00
2998	15718	15.6	54	4.63		4.5 100% Bella-Dura(r) Polyolefin	USA	5407.73.2060	\$117.00
2998	15719	18	54	5		6.75 100% Bella-Dura(r) Polyolefin	USA	5407.73.2060	\$128.50
2998	15720	17.9	54	1		1 100% Bella-Dura(r) Polyolefin	USA	5407.73.2060	\$135.50
2998	15721	12.2	54	1.88		2.13 100% Bella-Dura(r) Polyolefin	USA	5407.73.2060	\$117.00
3011	15722	21.4	54	0		0 90% Cotton 10% Polyester	USA	5801.27.5010	\$102.50
3011	15723	23.9	54	0		0 51% Cotton 40% Rayon 9% Polyester	USA	5801.27.5010	\$102.50
3011	15724	18	54.5	0		0 93% Polyester 7% Rayon	KOREA	5801.37.5010	\$86.50
2999	15725	20	54	0		0 100% Polyester	USA	5801.37.5020	\$96.00
2999	15726	20	54.5	0		0 100% Polyester	KOREA	5801.37.5010	\$68.00
2983	15733	20.6	54	15		13.25 100% Acrylic	USA	5512.29.0090	\$149.50
2998	15734	12.2	54	0		0 100% Bella-Dura(r) Polyolefin	USA	5407.73.2060	\$81.00
3009	15735	11.1	57	0		0 82% Polyester 18% Rayon	USA	5801.36.0010	\$70.00
3009	15736	11.9	57	0		0 64% Polyester 36% Cotton	USA	5801.36.0010	\$70.00
3009	15737	14.6	56	1		1.5 100% Polyester	USA	5903.90.2500	\$64.00
3009	15738	13.2	56.5	1		1.13 100% Polyester	USA	5801.36.0010	\$70.00
3009	15739	16.3	58	0		0 79% Rayon 21% Polyester	USA	5801.36.0010	\$76.50
3009	15740	14.1	57	0		0 100% Polyester	USA	5801.36.0010	\$70.00
3009	15741	14.3	55	0		0 100% Polyester	USA	5903.90.2500	\$64.00
3009	15742	16.5	53.5	1.13		0.5 100% Polyester	USA	5903.90.2500	\$64.00
3009	15743	15.8	56.5	13.63		0.13 54% Cotton 46% Polyester	USA	5903.90.3090	\$70.00
3009	15744	14.7	56.5	0.75		0.75 100% Polyester	USA	5903.90.2500	\$64.00
3009	15745	16.1	57	0		0 87% Polyester 13% Cotton	USA	5801.36.0010	\$64.00
3009	15746	15.4	58	0		0 100% Polyester	USA	5903.90.2500	\$64.00
3015	DU15747	20	55	3		2.75 60% Rayon 40% Polyester	CHINA	5516.93.0020	\$126.50
3015	15748	13.4	54	15.13		8.88 50% Cotton 50% Polyester	INDIA	5407.83.0090	\$87.50
3014	15749	16.7	55	4.75		4.75 51% Polyester 49% Acrylic	TURKEY	5801.36.0010	\$94.50
3015	15750	20.4	55	10.63		14.13 79% Polyester 21% Cotton	TURKEY	5801.36.0010	\$96.50
3015	15751	14.8	54	1		1.25 83% Polyester 17% Linen	TURKEY	5515.19.0090	\$82.00
3015	15752	17	54	0		0 43% Viscose 42% Cotton 9%Linen 6% Polyester	TURKEY	5801.36.0010	\$94.50
3015	15753	16.5	55	10		13.75 59% Acrylic 23% Polyester18% Cotton	TURKEY	5801.36.0010	\$115.00
3015	15754	14	55	9		10.88 64% Viscose 36% Polyester	TURKEY	5801.36.0010	\$94.50
3015	15755	21.2	55	0		6.63 100% Cotton	INDIA	5209.41.6020	\$92.50
3015	15756	17	55	0		4.5 100% Cotton	INDIA	5209.41.6020	\$95.00
3015	15757	16.8	55	8.38		3.5 45% Viscose 31% Polyester19% Cotton 5% Linen	TURKEY	5516.23.1000	\$119.50
3015	15758	29.4	55	6.75		4.63 90% Polyester 10% Cotton	TURKEY	5801.37.0000	\$115.00
3013	15759	19.1	54	0		0 63% Rayon 37% Polyester	USA	5801.36.0010	\$109.00
3015	DU15760	25.3	55.75	0		8.75 84% Cotton 16% Polyester	USA	5906.99.1000	\$72.50
3014	DU15761	36.1	56	21		13.5 88% Cotton 12% Polyester	USA	5906.99.1000	\$124.00
3015	DU15762	16.6	58.75	7.13		7.5 53% Polyester 47% Rayon	USA	5516.23.0090	\$94.00
3015	DU15763	30.3	56.5	6.5		2.38 85% Cotton 15% Polyester	USA	5903.90.3090	\$89.50
3015	DU15764	3.4	57	11.88		2.38 62% Rayon 27% Cotton 11%Polyester	USA	5903.90.2500	\$114.50
3015	DU15765	30.7	57.75	5.88		3.63 57% Cotton 31% Rayon 12%Polyester	USA	5903.90.2500	\$95.50
3015	DU15766	23	54	6.38		9 47% Cotton 38% Rayon 15%Polyester	USA	5801.36.0010	\$114.50
3015	DU15767	31.5	53.5	7.13		4.5 83% Cotton 17% Polyester	USA	5211.49.0020	\$114.50
3015	DU15768	22.5	52.75	13.13		6.5 74% Cotton 26% Polyester	USA	5211.49.0020	\$102.50
3033	DF15769	22.5	55	0		0 80% Polyvinyl chloride 18% Polyester2% Polyurethane	TURKEY	5903.10.2090	\$62.50
3033	DF15770	22.5	55	0		0 73% Polyvinyl chloride 24% Polyester3% Polyurethane	TURKEY	5903.10.2090	\$62.50
3033	DF15771	27.9	55	0		0 76% Polyvinyl chloride 22% Polyester2% Polyurethane	TURKEY	5903.10.2090	\$69.50
3033	DF15772	22.5	55	0		0 73% Polyvinyl chloride 24% Polyester3% Polyurethane	TURKEY	5903.10.2090	\$66.50
3033	DF15773	20.3	55			78% Polyvinyl chloride 22% Polyester	TURKEY	5903.10.2090	\$50.00
3033	DF15774	22.5	55			78% Polyvinyl chloride 20% Polyester2% Polyurethane	TURKEY	5903.10.2090	\$62.50

**Duralee
Retail Price List
(Limited Stock items excluded)**

Prices effective - July 1, 2016

Book	Pattern	Weight	Width	Vertical	Horizontal	Content	Origin	Tariff1	Retail
				Repeat	Repeat				
3033	DF15775	20.3	55		0	0 76% Polyvinyl chloride 22% Polyester2% Polyurethane	TURKEY	5903.10.2090	\$56.50
3033	DF15776	31.6	55			77% Polyvinyl chloride 21% Polyester2% Polyurethane	TURKEY	5903.10.2090	\$98.00
3033	DF15777	25.1	55		0	0 80% Polyvinyl chloride 18% Polyester2% Polyurethane	TURKEY	5903.10.2090	\$98.00
3033	DF15778	24.9	55		0	0 82% Polyvinyl chloride 12% Polyester6% Polyurethane	TURKEY	5903.10.2090	\$87.50
3033	DF15779	22.5	55		0	0 80% Polyvinyl chloride 18% Polyester2% Polyurethane	TURKEY	5903.10.2090	\$62.50
3033	DF15780	25.3	55		0	0 75% Polyvinyl chloride 21% Polyester4% Polyurethane	TURKEY	5903.10.2090	\$90.00
3033	DF15781	24.9	55			80% Polyvinyl chloride 18% Polyester2% Polyurethane	TURKEY	59013.10209	\$66.50
3033	DF15782	22.5	55		0	0 78% Polyvinyl chloride 20% Polyester2% Polyurethane	TURKEY	5903.10.2090	\$62.50
3033	DF15783	24	55		0	0 74% Polyvinyl chloride 23% Polyester3% Polyurethane	TURKEY	5903.10.2090	\$90.00
3033	DF15784	22.5	55		0	0 75% Polyvinyl chloride 22% Polyester3% Polyurethane	TURKEY	5903.10.2090	\$62.50
3033	DF15785	24.9	55		0	0 80% Polyvinyl chloride 18% Polyester2% Polyurethane	TURKEY	5903.10.2090	\$62.50
3033	DF15786	26.2	55		0	0 78% Polyvinyl chloride 20% Polyester2% Polyurethane	TURKEY	5903.10.2090	\$71.00
3033	DF15787	24.9	55			75% Polyvinyl chloride 22% Polyester3% Polyurethane	TURKEY	5903.10.2090	\$66.50
3033	DF15788	27.1	55			77% Polyvinyl chloride 20% Polyester3% Polyurethane	TURKEY	5903.10.2090	\$73.50
3033	DF15789	23.5	55		0	0 76% Polyvinyl chloride 22% Polyester2% Polyurethane	TURKEY	5903.10.2090	\$62.50
3033	DF15790	24.9	55		0	0 74% Polyvinyl chloride 22% Polyester4% Polyurethane	TURKEY	5903.10.2090	\$65.00
3033	DF15791	24	55		0	0 83% Polyvinyl chloride 15% Polyester2% Polyurethane	TURKEY	5903.10.2090	\$62.50
3033	DF15792	31.6	55		0	0 77% Polyvinyl chloride 21% Polyester2% Polyurethane	TURKEY	5903.10.2090	\$96.00
3033	DF15793	31.6	55			77% Polyvinyl chloride 21% Polyester2% Polyurethane	TURKEY	5903.10.2090	\$96.00
3033	DF15794	27.1	55			83% Polyvinyl chloride 15% Polyester2% Polyurethane	TURKEY	5903.10.2090	\$75.00
3033	DF15795	22.5	55		0	0 73% Polyvinyl chloride 24% Polyester3% Polyurethane	TURKEY	5903.10.2090	\$66.50
3033	DF15796	22.5	55			85% Polyvinyl chloride 12% Polyester3% Polyurethane	TURKEY	5903.10.2090	\$71.00
3033	DF15797	26.7	55		0	0 82% Polyvinyl chloride 15% Polyester3% Polyurethane	TURKEY	5903.10.2090	\$81.50
3029	DU15798	17.6	55	6.5	2.5	100% Polyester	CHINA	5801.36.0010	\$68.00
3030	DU15799	20	57	2.75	3.13	100% Polyester	CHINA	5906.99.2500	\$78.50
3030	DU15800	20	57	4.75	3.38	100% Polyester	CHINA	5906.99.2500	\$78.50
3036	DU15811	11.8	55	0		0 96% Polyester 4% Nylon	CHINA	5801.36.0010	\$82.00
3067	DN15820	22.9	55	0		0 49% Polyester 43% Acrylic8% Viscose	TURKEY	5801.36.0010	\$86.50
3067	DN15821	29.1	55	14.38	7	49% Polyester 43% Acrylic8% Viscose	TURKEY	5801.36.0010	\$93.00
3067	DN15822	25.7	55	6.63	14.13	60% Polyester 34% Acrylic6% Viscose	TURKEY	5801.36.0010	\$86.50
3067	DN15823	24.9	55	6.63	7	58% Polyester 36% Acrylic6% Viscose	TURKEY	5801.36.0010	\$90.00
3067	DN15824	24.9	55	1.75	0.38	53% Polyester 40% Acrylic7% Viscose	TURKEY	5801.36.0010	\$86.50
3067	DN15825	21.7	55	10	7	49% Polyester 43% Acrylic8% Viscose	TURKEY	5801.36.0010	\$93.00
3067	DN15826	22.6	55	0	0	0 53% Polyester 40% Acrylic7% Viscose	TURKEY	5801.36.0010	\$86.50
3067	DN15827	25.4	55	0	0	0 59% Polyester 35% Acrylic6% Viscose	TURKEY	5801.36.0010	\$86.50
3038	DV15862	13.7	54	0	0	0 100% Polyester	CHINA	5903.90.1500	\$49.00
3039	DU15863	12.8	59	6.63	9.25	100% Polyester	U.K.	5801.37.5010	\$110.00
3039	DU15864	12.8	59	12.63	12.63	100% Polyester	U.K.	5801.37.5010	\$110.00
3039	DU15865	12.8	59	12.75	23	100% Polyester	U.K.	5801.37.5010	\$110.00
3039	DU15866	12.8	59	8.25	23.25	100% Polyester	U.K.	5801.37.5010	\$110.00
3039	DU15867	12.8	59	6.63	12	100% Polyester	U.K.	5801.37.5010	\$110.00
3039	DU15868	12.8	59	25.75	17.13	100% Polyester	U.K.	5801.37.5010	\$110.00
3039	DU15869	12.8	59	18.88	9	100% Polyester	U.K.	5801.37.5010	\$110.00
3039	DU15870	12.8	59	12.63	32.25	100% Polyester	U.K.	5801.37.5010	\$110.00
3039	DU15871	12.8	59	15.38	28.5	100% Polyester	U.K.	5801.37.5010	\$110.00
3039	DU15872	12.8	59	6.25	12.63	100% Polyester	U.K.	5801.37.5010	\$110.00
3039	DU15873	12.8	59	19.25	18.13	100% Polyester	U.K.	5801.37.5010	\$110.00
3039	DU15874	12.8	59	15.38	30.38	100% Polyester	U.K.	5801.37.5010	\$110.00
3039	DU15875	12.8	59	25.75	18.13	100% Polyester	U.K.	5801.37.5010	\$110.00
3053	SU15876	4.4	56	26.13	27.13	61% Cotton 39% Polyester	TURKEY	5211.39.0090	\$68.00
3053	SV15877	17	55	0	6.88	54% Polyester 46% Rayon	CHINA	5801.37.5010	\$72.50
3053	SU15878	18.3	57	1.75	1.75	100% Polyester	CHINA	5407.61.9955	\$59.50
3053	SV15879	18.7	55	6.88	8.88	60% Rayon 40% Polyester	CHINA	5801.37.5010	\$86.00
3053	SU15880	18.3	55	0.38	0.38	85% Polyester 15% Linen	CHINA	5903.20.2500	\$59.50
3053	SU15881	18.1	55	3.38	7	69% Rayon 31% Polyester	CHINA	5516.23.0090	\$59.50
3053	SU15882	18.7	54	7.5	15	82% Polyester 18% Cotton	CHINA	5514.30.3310	\$79.00
3053	SU15883	11.9	55.5	2.5	2.5	100% Polyester	CHINA	5515.12.0090	\$59.50
3041	DN15884	13	54	0	0	0 100% Polyester	CHINA	5407.52.2060	\$30.00

Duralee
Retail Price List
(Limited Stock items excluded)

Prices effective - July 1, 2016

Book	Pattern	Weight	Width	Vertical Repeat	Horizontal Repeat	Content	Origin	Tariff1	Retail
3041	DN15885	16	54		0	0 100% Polyester	CHINA	5407.52.2060	\$40.00
3041	DN15886	17	54		0	0 100% Polyester	CHINA	5407.52.2060	\$40.00
3041	DN15887	15	54		0	0 100% Polyester	CHINA	5407.52.2060	\$40.00
3041	DN15888	14	54		0	0 100% Polyester	CHINA	5407.52.2060	\$44.00
3041	DN15889	21	54		0	0 100% Polyester	CHINA	5407.52.2060	\$40.00
3041	DN15890	19	54		0	0 92% Polyester 8% Linen	CHINA	5407.52.2060	\$40.00
3056	DU15892	10	57	10.25		7 55% Linen 45% Cotton	TURKEY	5309.29.3070	\$113.50
3056	DU15893	11.7	55	9.5		2.5 35% Cotton 32% Viscose 26% Polyester 7% Linen	TURKEY	5801.36.0010	\$94.50
3055	DU15894	10.6	54		7	14 41% Viscose 32% Cotton 27% Polyester	TURKEY	5801.36.0010	\$94.50
3056	DU15895	8.8	54		1	6.88 46% Viscose 36% Polyester18% Cotton	TURKEY	5801.36.0010	\$97.50
3056	DU15896	17.9	54	13.5		13.88 55% Cotton 45% Viscose	INDIA	5211.44.9020	\$111.50
3056	DU15897	15.9	54	2.75		9.25 50% Viscose 30% Cotton 20% Polyester	INDIA	5516.43.0020	\$97.50
3056	DU15898	24.6	55.5		5	3.5 100% Polyester	USA	5515.12.0090	\$108.00
3056	DU15899	15.9	54		4.5	18.5 80% Viscose 20% Polyester	INDIA	5516.23.0090	\$104.50
3056	DV15900	22.6	55		4	14 60% Rayon 40% Polyester	CHINA	5801.38.5010	\$134.00
3055	DV15901	25.1	55		3.5	1.75 60% Rayon 40% Polyester	CHINA	5801.37.5010	\$134.00
3056	DV15902	25	55	10.25		7 60% Rayon 40% Polyester	CHINA	5801.37.5010	\$102.50
3056	DU15903	15	54	29.5		13.75 56% Acrylic 40% Polyester4% Viscose	TURKEY	5801.36.0010	\$75.50
3055	DU15904	15.9	54	6.25		4.75 62% Acrylic 27% Polyester11% Viscose	TURKEY	5801.36.0020	\$114.50
3056	DU15905	14.7	56	4.38		2.38 41% Viscose 33% Cotton 26% Polyester	TURKEY	5801.36.0010	\$96.50
3056	DU15906	15.7	55	13.38		14 81% Viscose 19% Polyester	TURKEY	5516.23.0090	\$105.50
3056	DU15907	13.5	55	5.5		7 78% Viscose 22% Polyester	TURKEY	5516.23.0090	\$103.50
3056	DV15908	18	55		2.5	1.75 100% Polyester	TURKEY	5801.37.5010	\$81.50
3056	DU15909	14.3	54	13.5		0.38 47% Viscose 30% Polyester15% Cotton 8% Linen	ITALY	5801.36.0010	\$143.00
3056	DV15910	17	55		3.5	12.5 70% Rayon 30% Polyester	CHINA	5801.37.5010	\$99.00
3056	DU15911	22.6	57	26.25		28.5 86% Polyester 6% Cotton 4% Linen 4% Rayon	CHINA	5407.83.0090	\$77.00
3055	DU15912	27.2	55.5		5.13	4.5 62% Cotton 38% Rayon	USA	5801.26.0010	\$102.00
3056	DU15913	21.6	57	1.63		0.75 64% Rayon 36% Polyester	USA	5801.36.0010	\$108.00
3056	DU15914	20.7	52	2.38		4.25 76% Rayon 24% Polyester	USA	5801.36.0010	\$89.50
3056	DU15915	24	55	12.5		13.88 85% Rayon 15% Polyester	USA	5801.36.0010	\$114.50
3057	DV15916	20.8	54		0	0 100% Polyester	CHINA	5903.10.3000	\$138.00
3069	DU15917	19.4	56.5	3.75		0.25 44% Cotton 37% Rayon 18%Polyester 1% Nylon	USA	5903.90.2500	\$82.00
3043	DW15918	18.4	54	2.38		1.5 70% Cotton 30% Polyester	CHINA	5211.49.0020	\$58.50
3043	DW15919	17.4	55	19.38		28 56% Polyester 44% Rayon	CHINA	5515.12.0090	\$93.00
3043	DW15920	13.9	54	9.25		7 34% Polyester 34% Cotton32% Rayon	CHINA	5514.30.3310	\$63.50
3049	DV15921	20.4	54		0	0 93% Cotton 7% Polyester	TURKEY	5801.27.5010	\$114.00
3065	DV15922	10.6	57	0.25		1.25 80% Polyester 20% Nylon	CHINA	5801.32.0000	\$55.00
3065	DW15923	9.4	57	2.5		0 100% Polyester	CHINA	5801.36.0010	\$55.00
3065	DW15924	14	55	6.25		14.5 60% Cotton 40% Polyester	CHINA	5211.49.0020	\$50.00
3063	DV15925	16	55		0	3.5 50% Polyester 50% Rayon	CHINA	5516.93.0020	\$85.00
3066	DV15926	22.8	56		0	4.38 100% Polyester	CHINA	5512.19.0005	\$65.00
3066	DW15927	10.9	55		0	0 100% Polyester	CHINA	5407.61.9955	\$45.00
3066	DW15928	18.4	54	0.38		0.38 100% Polyester	INDIA	5407.93.2020	\$73.50
3066	DW15929	15.1	57	1.25		1.13 80% Polyester 20% Polypropylene	CHINA	5407.53.2060	\$55.00
3064	DW15930	12.7	57	2.25		1.5 69% Cotton 31% Polyester	CHINA	5211.39.0090	\$55.00
3066	DW15931	13.8	55		0	0 65% Polyester 35% Acrylic	CHINA	5801.36.0020	\$70.00
3066	DV15932	10.3	54		9	13.5 100% Polyester	CHINA	5801.36.0010	\$70.00
3066	DW15933	13.5	57	1.25		0.75 55% Polyester 45% Cotton	CHINA	5407.93.2090	\$65.00
3066	DW15934	12.2	54	6.75		4.5 52% Cotton 48% Polyester	TAIWAN	5211.31.0035	\$60.00
3066	DW15935	15	59		0	0 100% Polyester	CHINA	5801.36.0010	\$42.50
3066	DW15936	24	54	13.75		6.75 100% Polyester	CHINA	5801.36.0010	\$62.00
3066	DV15937	14.4	58	0.5		1 90% Polyester 10% Nylon	CHINA	5801.37.5010	\$55.00
3066	DV15938	14.4	57		0	0 100% Polyester	CHINA	6006.32.0080	\$51.50
3066	DW15939	13.4	57		3	2.63 59% Polyester 41% Cotton	INDIA	5514.30.3310	\$62.50
3066	DW15940	14	56		1	1.25 40% Polyester 32% Acrylic28% Cotton	CHINA	5801.36.0020	\$55.00
3066	DW15941	16	58	3.5		5.5 70% Rayon 30% Polyester	CHINA	5801.36.0010	\$60.00
3066	DW15942	17	57		0	0 100% Polyester	CHINA	5801.36.0010	\$65.00
3063	DW15943	12	58	6.5		7.5 100% Polyester	CHINA	5407.69.4060	\$50.00

**Duralee
Retail Price List
(Limited Stock items excluded)**

Prices effective - July 1, 2016

Book	Pattern	Weight	Width	Vertical Repeat	Horizontal Repeat	Content	Origin	Tariff1	Retail
3065	DW15944	12.1	57		0	0 100% Polyester	CHINA	5407.61.9955	\$45.00
2642	20872	12	54	25.25	27	100% Cotton Ottoman	USA	5209.59.0090	\$80.50
2642	20874	12	54	27	27	95% Cotton 5% Linen	USA	5212.25.6090	\$77.50
2642	20875	12	54	27	27	100% Cotton Duck	USA	5209.51.6090	\$78.50
2642	20876	12	54	18	13.5	100% Cotton Duck	USA	5209.51.6090	\$78.50
2642	20877	12	54	27	27	95% Cotton 5% Linen	USA	5212.25.6090	\$77.50
2738	20956	12	54	27	27	100% Cotton Duck	USA	5209.51.6090	\$78.50
2738	20962	13	54	25.25	6.75	100% Cotton Ottoman	USA	5209.59.0090	\$80.50
2738	20963	13	54	27	27	95% Cotton 5% Linen	USA	5212.25.6090	\$79.50
2738	20964	13	54	6.38	2.75	95% Cotton 5% Linen	USA	5212.25.6090	\$79.50
2738	20965	13	54	27	27	95% Cotton 5% Linen	USA	5212.25.6090	\$79.50
2765	20993	12	54	13.5	13.5	55% Linen 45% Cotton	USA	5212.25.6090	\$86.50
2765	20994	12	54	13.5	13.5	100% Cotton	USA	5209.51.6090	\$76.00
2765	20995	12	54	9	6.75	100% Cotton	USA	5209.51.6090	\$76.00
2765	20996	12	54	9	9	55% Cotton 45% Linen	USA	5212.25.6090	\$83.50
2780	20999	15	54	27	13.5	55% Linen 45% Rayon	USA	5309.29.4010	\$84.50
2780	21001	16	54	27	27	55% Cotton 45% Linen	USA	5212.25.6090	\$82.50
2780	21002	16	54	25.25	13.5	95% Cotton 5% Linen	USA	5212.25.6090	\$68.50
2780	21003	16	54	25.25	27	55% Cotton 45% Linen	USA	5212.25.6090	\$88.00
2780	21004	12	54	0	9	95% Cotton 5% Linen	USA	5212.25.6090	\$77.00
2780	21005	12	54	4.5	4.5	100% Cotton Slub Duck	USA	5209-19-0090	\$68.50
2792	21006	13.5	54	27	27	55% Cotton 45% Linen	USA	5212.25.6090	\$85.00
2792	21007	13.5	54	27	27	55% Cotton 45% Linen	USA	5212.25.6090	\$84.00
2793	21008	11.2	54	36	13.5	100% Linen	USA	5309.11.0010	\$101.50
2793	21009	13.5	54	13.5	9	55% Linen 45% Rayon	USA	5309.29.4010	\$84.00
2804	21010	12	54	27	27	55% Linen 45% Rayon	USA	5309-29-4010	\$94.50
2804	21012	12	54	27	27	100% Cotton Duck	USA	5209.51.6090	\$71.50
2804	21013	13	54	24.25	13.5	55% Cotton 45% Linen	USA	5212.25.6090	\$89.00
2804	21014	13	54	27	13.5	55% Cotton 45% Linen	USA	5212.25.6090	\$87.00
2804	21015	13	54	27	27	95% Cotton 5% Linen	USA	5212.25.6090	\$75.00
2804	21016	13	54	27	27	100% Cotton Duck	USA	5209.51.6090	\$79.00
2804	21017	13	54	6.38	6.75	100% Cotton Duck	USA	5209.51.6090	\$68.00
2804	21018	13	54	27	27	95% Cotton 5% Linen	USA	5212.25.6090	\$78.50
2804	21019	13	54	27	27	95% Cotton 5% Linen	USA	5212.25.6090	\$73.00
2804	21020	11	54	25.25	27	100% Cotton Duck	USA	5209.51.6090	\$89.00
2823	21023	12	54	12.63	27	55% Linen 45% Rayon	USA	5309-29-4010	\$91.50
2823	21024	12	54	13.5	13.5	55% Cotton 45% Linen	USA	5212.25.6090	\$87.00
2823	21025	12	54	12.63	13.5	95% Cotton 5% Linen	USA	5212.25.6090	\$86.00
2823	21026	12	54	27	13.5	55% Linen 45% Rayon	USA	5309-29-4010	\$81.50
2823	21027	12	54	27	25	55% Cotton 45% Linen	USA	5212.25.6090	\$89.00
2823	21028	12	54	12.63	13.5	100% Cotton Duck	USA	5209.51.6090	\$79.00
2823	21029	12	54	25.25	13.5	95% Cotton 5% Linen	USA	5212.25.6090	\$79.50
2823	21030	12	54	25.25	13.5	100% Cotton Duck	USA	5209-19-0090	\$81.50
2823	21031	12	54	25.25	13.5	55% Linen 45% Rayon	USA	5309-29-4010	\$92.00
2823	21032	12	54	25.25	13.5	100% Cotton Slub Duck	USA	5209-19-0090	\$76.50
2823	21033	12	54	27	25.25	100% Cotton Ottoman	USA	5209.59.0090	\$80.00
2846	21034	14	54	13.5	13.88	55% Linen 45% Rayon	USA	5309-29-4010	\$86.00
2846	21035	13	54	27	27	55% Cotton 45% Linen	USA	5212.25.6090	\$89.50
2846	21036	13	54	12.5	13.5	55% Cotton 45% Linen	USA	5212.25.6090	\$87.00
2846	21037	13	54	27	27	55% Cotton 45% Linen	USA	5212.25.6090	\$87.00
2846	21038	13	54	13.5	27	95% Cotton 5% Linen	USA	5212.25.6090	\$79.50
2846	21039	13	54	27.5	30.5	100% Linen	USA	5309-11-0010	\$104.00
2846	21040	13	54	9	27	55% Linen 45% Rayon	USA	5309-29-4010	\$84.50
2846	21041	13	54	12.63	18	95% Cotton 5% Linen	USA	5212.25.6090	\$78.50
2846	21042	14	54	27	27	55% Cotton 45% Linen	USA	5212.25.6090	\$89.50
2879	21043	16	54	13.5	13.5	100% Cotton Duck	USA	5209.51.6090	\$73.50
2879	21044	12	54	9	13.5	100% Cotton	USA	5209190000	\$77.00
2879	21045	12	54	6.75	27	100% Cotton	USA	5209-19-0090	\$80.50

**Duralee
Retail Price List
(Limited Stock items excluded)**

Prices effective - July 1, 2016

Book	Pattern	Weight	Width	Vertical	Horizontal	Content	Origin	Tariff1	Retail
				Repeat	Repeat				
2879	21046	12	54	6.75	6.75	55% Cotton 45% Linen	USA	5212.25.6090	\$86.50
2879	21047	16	54	6.75	3.38	100% Cotton Duck	USA	5209.51.6090	\$73.50
2879	21048	12	54	25.25	13.5	55% Cotton 45% Linen	USA	5212.25.6090	\$86.50
2879	21049	12	54	18	9	55% Linen 45% Rayon	USA	5309.29.4010	\$86.50
2879	21050	16	54	3.63	3.85	100% Cotton Duck	USA	5212.51.6090	\$73.50
2879	21051	16	54	5	2.45	100% Cotton Slub Duck	USA	5209.19.0090	\$71.50
2908	21052	14	54	27	25.25	55% Cotton 45% Linen	USA	5212.21.6090	\$103.00
2908	21053	12	54	25.25	13.5	55% Linen 45% Rayon	USA	5309.29.4010	\$81.50
2908	21054	12	54	25.25	27	95% Cotton 5% Linen	USA	5212.25.6090	\$77.00
2908	21055	12	54	25.25	27	100% Cotton Percale	USA	5209.19.0090	\$75.00
2908	21056	12	54	25.25	27	95% Cotton 5% Linen	USA	5212.25.6090	\$78.00
2908	21057	12	54	13.5	13.5	55% Cotton 45% Linen	USA	5212.21.6090	\$86.50
2908	21058	12	54	27.5	27	100% Cotton	USA	5208.29.2020	\$77.00
2908	21059	12	54	25.25	13.5	55% Cotton 45% Linen	USA	5212.21.6090	\$86.50
2908	21060	12	54	18	9	95% Cotton 5% Linen	USA	5212.25.6090	\$75.00
2908	21061	12	54	27	27	55% Linen 45% Rayon	USA	5309.29.4010	\$86.50
2908	21062	14	54	0	9	100% Cotton China Twill	USA	5209.59.0040	\$76.00
2908	21063	12	54	25.25	27	100% Cotton Percale	USA	5209.19.0090	\$75.00
2931	21064	15	54	27	27	100% Acrylic	USA	5512.29.0090	\$91.00
2931	21065	15	54	27	27	100% Acrylic	USA	5512.29.0090	\$92.50
2931	21066	15	54	13.5	5.38	100% Acrylic	USA	5512.29.0090	\$92.50
2931	21067	15	54	25.25	27	100% Acrylic	USA	5512.29.0090	\$92.50
2931	21068	15	54	27	13.5	100% Acrylic	USA	5512.29.0090	\$92.50
2931	21069	15	54	27	27	100% Acrylic	USA	5512.29.0090	\$92.50
2931	21070	15	54	27	9	100% Acrylic	USA	5512.29.0090	\$92.50
2931	21071	15	54	25.25	27	100% Acrylic	USA	5512.29.0090	\$92.50
2931	21072	15	54	27	27	100% Acrylic	USA	5512.29.0090	\$92.50
2931	21073	15	54	27	27	100% Acrylic	USA	5512.29.0090	\$92.50
2931	21074	15	54	13.5	13.5	100% Acrylic	USA	5512.29.0090	\$92.50
2937	21075	12	54	9	3.38	100% Cotton	USA	5209.19.0090	\$81.50
2937	21076	12	54	27	13.5	100% Linen	USA	5309.11.0010	\$99.50
2937	21077	12	54	13.5	13.5	55% Cotton 45% Linen	USA	5212.21.6090	\$85.50
2937	21078	12	54	9	6.75	95% Cotton 5% Linen	USA	5212.25.6090	\$79.00
2937	21079	14	54	8.38	27	100% Cotton Duck	USA	5209.51.6090	\$94.50
2937	21080	12	54	18	13.5	95% Cotton 5% Linen	USA	5212.25.6090	\$80.50
2937	21081	12	54	25.25	13.5	100% Linen	USA	5309.11.0010	\$103.00
2937	21082	12	54	18	6.75	95% Cotton 5% Linen	USA	5212.25.6090	\$79.50
2937	21083	12	54	3	3.75	100% Cotton	USA	5209.19.0090	\$80.50
2937	21084	12	54	13.5	13.5	100% Cotton	USA	5209.19.0090	\$77.00
2937	21085	12	54	24.75	54.75	95% Cotton 5% Linen	USA	5212.25.6090	\$81.50
2937	21086	12	54	27	13.5	95% Cotton 5% Linen	USA	5212.25.6090	\$80.50
2937	21087	12	54	3.13	5.38	95% Cotton 5% Linen	USA	5212.25.6090	\$79.50
2965	21088	12	54	18	13.5	95% Cotton 5% Linen	USA	5209190000	\$75.50
2965	21089	12	54	13.5	13.5	100% Linen	USA	5309110000	\$95.00
2965	21090	12	54	6.75	3.38	95% Cotton 5% Linen	USA	5209190000	\$75.50
2965	21091	12	54	25.25	27	95% Cotton 5% Linen	USA	5209190000	\$75.50
2965	21092	12	54	8.38	9	100% Cotton Ottoman	USA	5209190000	\$75.50
2965	21093	12	54	13.5	13.5	95% Cotton 5% Linen	USA	5209.19.0090	\$69.00
2984	21095	12	54	9	13.5	95% Cotton 5% Linen	USA	5209.19.0090	\$61.50
2984	21096	12	54	18	13.5	100% Cotton China Twill	USA	5209.12.0000	\$61.50
2984	21097	12	54	13.5	13.5	100% Cotton Duck	USA	5209.19.0090	\$61.50
2984	21098	12	54	3.63	3.88	100% Cotton Duck	USA	5209.19.0090	\$61.50
2984	21100	12	54	8.38	6	100% Cotton China Twill	USA	5209.12.0000	\$61.50
2984	21101	12	54	27	27	100% Cotton Duck	USA	5209.19.0090	\$61.50
2984	21102	12	54	18	9	95% Cotton 5% Linen	USA	5209.19.0090	\$61.50
2984	21103	12	54	0	1.75	100% Cotton China Twill	USA	5209.12.0000	\$61.50
2984	21104	12	54	27	27	100% Cotton Duck	USA	5209.19.0090	\$61.50
2984	21105	12	54	27	27	100% Cotton Slub Duck	USA	5209.19.0090	\$61.50

Duralee
Retail Price List
(Limited Stock items excluded)

Prices effective - July 1, 2016

Book	Pattern	Weight	Width	Vertical	Horizontal	Content	Origin	Tariff1	Retail
				Repeat	Repeat				
2984	21106	12	54	1.5	1	100% Cotton China Twill	USA	5209.12.0000	\$61.50
2984	21107	12	54	2.25	1.5	100% Cotton China Twill	USA	5209.12.0000	\$61.50
2984	21108	12	54	27	13.5	100% Cotton China Twill	USA	5209.12.0000	\$61.50
2984	21109	12	54	0	6	100% Cotton Duck	USA	5209.19.0090	\$61.50
2984	21110	12	54	13.5	13.5	95% Cotton 5% Linen	USA	5209.19.0090	\$61.50
2984	21111	12	54	13.5	13.5	100% Cotton Ottoman	USA	5209.19.0090	\$61.50
2984	21112	12	54	25.25	6.75	95% Cotton 5% Linen	USA	5209.19.0090	\$61.50
2984	21113	12	54	27	13.5	100% Cotton Duck	USA	5209.19.0090	\$61.50
2984	21114	12	54	27	27	100% Cotton China Twill	USA	5209.12.0000	\$61.50
2984	21115	12	54	13.5	13.5	95% Cotton 5% Linen	USA	5209.19.0090	\$61.50
2984	21116	12	54	9	9	100% Cotton Duck	USA	5209.19.0090	\$61.50
2984	21117	12	54	25.25	13.5	95% Cotton 5% Linen	USA	5209.19.0090	\$61.50
2984	21118	12	54	27	27	100% Cotton Duck	USA	5209.19.0090	\$61.50
2984	21119	12	54	13.5	13.5	95% Cotton 5% Linen	USA	5209.19.0090	\$61.50
2984	21120	12	54	1.25	1.25	100% Cotton China Twill	USA	5209.12.0000	\$61.50
2521	26168	28	54			77% Polyvinyl chloride 23% Polyester	TAIWAN		\$70.00
2803	31869	10.2	54	0	0	75% Polyester 25% Viscose	INDIA	5407.93.2010	\$47.00
2803	31870	11.7	54	0.88	1	100% Polyester	INDIA	5512.19.0045	\$54.00
2803	31872	7.4	54	0	0	100% Polyester	INDIA	5407-69-4060	\$49.00
2834	31888	8.4	54	0.38	0.25	52% Cotton 48% Polyester	TAIWAN	5211.49.0090	\$54.50
2704	32068	23.7	54	4.5	4.5	75% Linen 25% Cotton	INDIA	5309.29.4010	\$88.50
2753	32163	15.5	54	11.88	13.5	82% Cotton 18% Viscose	CHINA	5209.31.6090	\$117.50
2753	32168	15	54	11.5	10.75	84% Cotton 16% Viscose	CHINA	5211.31.0090	\$103.50
2753	32169	14.5	54	15.25	15.25	87% Cotton 13% Viscose	CHINA	5810.92.9080	\$103.50
2756	32172	4.6	54	0	0	100% Polyester	INDIA	5407-52-2040	\$30.00
2758	32174	8.4	54	0	0	100% Polyester	INDIA	5407.30.9000	\$47.00
2758	32175	9.3	54	0	0	89% Viscose 11% Silk	INDIA	5516-23-0090	\$52.00
2788	32205	18.6	54	0.63	0.5	100% Cotton	TURKEY	5209.49.0090	\$61.50
2777	32207	17.6	56	4.5	4.5	75% Cotton 25% Linen	CHINA	5212.24.6090	\$64.00
2777	32210	17.9	56	0	0.25	73% Cotton 27% Linen	CHINA	5212.24.6090	\$64.00
2777	32212	14.7	54	0	0	57% Linen 43% Cotton	USA	5309-29-3090	\$53.50
2786	32213	6.9	57	11.5	11.5	55% Nylon 45% Polyester	CHINA	5810-92-9080	\$58.50
2787	32215	12.7	57	15.75	37	100% Polyester	CHINA	5407-61-9950	\$58.50
2788	32219	7.2	54	0	1	100% Polyester	TURKEY	5407.69.4010	\$61.50
2785	32221	7.5	54.5	0	1.88	100% Polyester	TURKEY	5407.69.4010	\$62.00
2788	32222	8.1	54	0.5	0.5	100% Polyester	TURKEY	5407.69.3000	\$62.00
2788	32223	8.1	54	9.38	17.38	100% Polyester	INDONESIA	5407.52.2020	\$96.50
2787	32224	12.1	54.5	0.38	0.38	60% Cotton 40% Polyester	CHINA	5211.39.0090	\$48.50
2787	32225	12.1	55	1.5	1.5	100% Cotton	PORTUGAL	5209.41.6020	\$49.00
2782	32226	8.9	54.5	0	0	100% Cotton	TURKEY	5209.39.0060	\$49.00
2788	32229	11.2	55	3.5	3.5	100% Cotton	INDIA	5407.91.2010	\$48.50
2786	32230	11.7	54	0	0	51% Cotton 49% Polyester	TAIWAN	5211.49.0020	\$45.50
2802	32232	12.6	54	0	0	66% Cotton 34% Polyester	TAIWAN	5211-39-0090	\$49.00
2787	32235	17.9	54	0	0	70% Viscose 30% Linen	INDIA	5407.61.9935	\$49.50
2786	32236	15.4	54	0	0	100% Polyester	INDIA	5801.36.0020	\$46.00
2788	32237	20.5	54	0	0	100% Cotton	TURKEY	5209-39-0090	\$74.00
2787	32241	14.8	54	0	0.63	51% Cotton 49% Polyester	INDIA	5211-39-0090	\$44.50
2830	32242	14.9	55	0	1.75	52% Polyester 48% Cotton	INDIA	5407-82-0090	\$47.50
2787	32243	14.9	54	7.38	6.75	52% Polyester 48% Cotton	INDIA	5407-82-0090	\$47.50
2787	32245	16.4	55	0	0	53% Cotton 47% Polyester	INDIA	5211-39-0090	\$44.50
2834	32246	14.9	54	0	0	52% Polyester 48% Cotton	INDIA	5407-82-0090	\$47.50
2788	32247	21.1	55	0	0	45% Rayon 30% Linen 15% Cotton 10% Polyester	CHINA	5516.92.0090	\$64.00
2788	32256	26.2	56	0	0	70% Polyester 30% Linen	CHINA	5515.19.0090	\$78.50
2786	32260	13.9	54	10.88	13.5	61% Rayon 39% Polyester	CHINA	5801.36.0010	\$52.00
2787	32261	10.4	54	0	0.5	100% Cotton	PORTUGAL	5209.41.6020	\$44.50
2782	32270	8.8	58	1.88	7	100% Polyester	INDIA	5407-61-9955	\$59.50
2812	32273	15.5	54	0	4.5	56% Cotton 44% Polyester	TURKEY	5211.49.0020	\$54.50
2788	32279	21.5	54	0	9	54% Cotton 46% Polyester	TAIWAN	5211.49.0020	\$54.50

**Duralee
Retail Price List
(Limited Stock items excluded)**

Prices effective - July 1, 2016

Book	Pattern	Weight	Width	Vertical Repeat	Horizontal Repeat	Content	Origin	Tariff1	Retail
2785	32283	14.4	54		3	3.25 100% Cotton	INDIA	5209.49.0090	\$57.00
2788	32285	11.8	54		3	2.75 65% Cotton 35% Polyester	INDIA	5211-39-0090	\$86.50
2802	32328	12.6	54		0	0 66% Cotton 34% Polyester	TAIWAN	5211-39-0090	\$49.00
2803	32329	10.2	54		0	0 75% Polyester 25% Viscose	INDIA	5407.93.2010	\$47.00
2803	32330	11.7	54	0.88		1 100% Polyester	INDIA	5512.19.0045	\$54.00
2803	32331	7.4	54		0	0 100% Polyester	INDIA	5512.19.0005	\$50.00
2812	32334	8.2	55		0	0 34% Polyester 47% Viscose19% Linen	INDIA	5516-22-0090	\$51.00
2830	32338	9.3	54	3.88		3.88 100% Polyester	CHINA	5810-92-9080	\$58.00
2811	32340	9.7	51	6.25		5.75 100% Polyester	INDIA	5407.52.2020	\$91.50
2812	32341	10.4	54		0	0 50% Rayon 50% Polyester	INDIA	5516.23.0090	\$51.50
2812	32344	13.5	54		0	0 57% Rayon 43% Cotton	TAIWAN	5516-42-0090	\$43.50
2812	32345	12	54		0	4.63 100% Polyester	CHINA	5407.61.9955	\$44.50
2811	32346	10.5	51		3	2 67% Cotton 33% Polyester	INDIA	5210-39-6090	\$87.50
2807	32347	14.5	52	9.25		17 56% Polyester 44% Cotton	INDIA	5407-82-0090	\$85.00
2812	32349	12.4	54		0	0 56% Polyester 44% Cotton	INDIA	5407-82-0090	\$44.50
2810	32351	10.5	51	9.25		8.5 67% Cotton 33% Polyester	INDIA	5210-39-6060	\$95.00
2834	32353	17.5	54	1.25		3.38 54% Cotton 46% Polyester	TAIWAN	5211.49.0090	\$64.00
2812	32354	17.3	55	9.88		9.5 70% Cotton 30% Polyester	CHINA	5211.49.0020	\$59.00
2811	32355	16.6	56		0	0 100% Polyester	CHINA	5407.69.2060	\$49.50
2812	32359	18.8	54		0	0 100% Cotton	CHINA	5209-39-0090	\$59.00
2812	32362	9.5	58		0	0 100% Polyester	TAIWAN	5407-61-9935	\$42.50
2810	32363	15.9	56		0	5.13 71% Cotton 29% Linen	CHINA	5212-24-6090	\$55.00
2834	32366	5.8	59	14.75		7.25 100% Polyester	CHINA	5407-61-9955	\$42.50
2809	32367	14.8	59		0	2.13 100% Polyester	CHINA	5407-61-9935	\$35.00
2809	32368	11.9	54	3.38		3.38 50% Cotton 50% Polyester	CHINA	5407-83-0090	\$55.00
2812	32377	13.2	54		0	6.75 54% Cotton 46% Polyester	TAIWAN	5211.49.0020	\$54.50
2812	32379	21.4	54		0	0 74% Polyester 14% Rayon 10% Cotton 2% Linen	TURKEY	5407.92.2090	\$59.50
2812	32380	11.1	54		0	0.38 100% Cotton	CHINA	5209-43-0030	\$44.50
2812	32382	13.1	55		0	0.75 76% Cotton 24% Polyester	CHINA	5211.49.0020	\$59.00
2818	32383	6.6	55		0	5 100% Polyester	TURKEY	5407-43-2030	\$55.50
2840	32394	17	51.5		3	3 98% Flax 2% Cotton	INDIA	5514.21.0090	\$157.50
3002	32395	9.3	52	8.63		8.63 45% Linen 37% Cotton 18%Rayon	CHINA	5810.99.9000	\$90.00
2840	32396	6.6	57	8.88		11.5 90% Polyester 10% Wool	TURKEY	5407-69-4060	\$125.00
2840	32397	9.4	57	30		13.75 60% Polyester 40% Cotton	TURKEY	5407-83-0090	\$125.00
2826	32398	11.8	54		0	0 100% Cotton Duck	TURKMENISTAN	5209.39.0060	\$35.50
2832	32399	10.4	57		0	0 72% Polyester 28% Viscose	INDIA	5407-61-9905	\$53.00
2828	32402	9.3	54	13.63		11.5 100% Polyester	CHINA	5810-92-9080	\$59.00
2830	32403	9.3	53	7.25		2.75 100% Polyester	CHINA	5810.92.9080	\$51.50
2834	32406	5.1	51.5	9.38		12.88 70% Polyester 30% Rayon	INDIA	5407.53.2040	\$93.50
2830	32407	7.7	54		0	0.13 100% Polyester	INDIA	5407.52.2060	\$45.50
2834	32409	7	51	4.5		4.5 90% Rayon 10% Polyester	INDIA	5516.23.0090	\$111.50
2832	32411	7.7	54		0	2.25 100% Polyester	INDIA	5407.52.2060	\$46.50
2834	32412	15.9	55	14		7.25 70% Cotton 30% Polyester	CHINA	5211.49.0020	\$58.50
2834	32413	13.3	55		0	0 100% Linen	CHINA	5309.29.4090	\$63.00
2832	32414	11.5	54	4.5		4.5 53% Cotton 47% Polyester	TAIWAN	5211.49.0090	\$60.50
2834	32415	11.5	54		0	6.88 52% Cotton 48% Polyester	TAIWAN	5211.49.0090	\$60.50
2833	32416	15.9	54	0.38		0 100% Polyester	TURKEY	5515.12.0090	\$71.50
2829	32418	10.3	54	6.5		9 57% Cotton 43% Polyester	TAIWAN	5209-39-0080	\$44.00
2830	32419	10.3	54	7.63		6 57% Cotton 43% Polyester	TAIWAN	5209-39-0080	\$44.00
2831	32420	10.3	54	33.25		18 57% Cotton 43% Polyester	TAIWAN	5209-39-0080	\$44.00
2830	32421	11	54		0	0 54% Cotton 46% Polyester	CHINA	5211-49-0021	\$44.50
2832	32422	11	54		0	1.5 54% Cotton 46% Polyester	CHINA	5211-49-0021	\$44.50
2832	32423	11	54	7.5		7.5 54% Cotton 46% Polyester	CHINA	5211-49-0021	\$44.50
2832	32424	11	54	29.25		14.25 54% Cotton 46% Polyester	CHINA	5211-49-0021	\$44.50
2834	32425	11	54		0	0 60% Cotton 40% Polyester	TAIWAN	5407-61-9935	\$40.50
2834	32429	8.4	54	0.38		0.25 52% Cotton 48% Polyester	TAIWAN	5211.49.0090	\$54.50
2858	32430	15.9	54	0.25		0.75 100% Cotton	INDIA	5209.39.0090	\$68.50
2832	32431	14.4	56		0	0 92% Polyester 8% Rayon	CHINA	5801.36.0010	\$44.50

**Duralee
Retail Price List
(Limited Stock items excluded)**

Prices effective - July 1, 2016

Book	Pattern	Weight	Width	Vertical		Content	Origin	Tariff1	Retail
				Repeat	Repeat				
2829	32433	13.1	56		0	0 100% Polyester	CHINA	5407.72.0060	\$47.50
2831	32435	14.7	54	1.75		2 100% Polyester	CHINA	5801-36-0020	\$54.50
2832	32436	12.9	56	0.63		0.38 77% Polyester 23% Rayon	CHINA	5801.36.0020	\$54.50
2833	32438	17.6	56		1	0.5 100% Polyester	CHINA	5801.36.0020	\$54.50
2832	32439	18.6	56		0	0 100% Polyester	CHINA	5801.26.0020	\$44.50
2830	32440	23.8	54	0.13		0.5 100% Linen	CHINA	5809.19.0010	\$100.00
2833	32441	9.9	54	0.75		0.75 65% Cotton 35% Polyester	TAIWAN	5211.49.0090	\$59.50
2859	32442	14.5	60		0	0 100% Cotton	INDIA	5209.49.00	\$55.00
2833	32444	5.6	53	2.75		2.13 100% Polyester	INDIA	5407.61.9930	\$42.00
2832	32445	7.6	59		17	15 100% Polyester	CHINA	5407-61-9950	\$40.50
2832	32446	12.8	59	4.5		4.25 70% Polyester 30% Wool	CHINA	5512.19.0005	\$45.50
2831	32447	5.7	54.38	15.75		7.75 100% Polyester	CHINA	5407-61-9930	\$40.50
2829	32448	8.6	54		0	1.88 58% Cotton 42% Polyester	INDIA	5211.49.0020	\$64.00
2833	32451	8.4	54		0	3.88 61% Cotton 39% Polyester	INDIA	5211.49.0090	\$72.50
2834	32453	8.6	54		0	6.88 58% Cotton 42% Polyester	INDIA	5211.49.0020	\$67.50
2834	32455	10.3	55		0	2.88 56% Cotton 44% Polyester	TURKEY	5211.49.0020	\$54.50
2830	32458	8	54	4.38		3.5 60% Cotton 40% Polyester	CHINA	5210-39-6090	\$55.50
2834	32459	12.9	55		0	0 52% Cotton 48% Polyester	INDIA	5211-32-0020	\$45.50
2870	32460	11.5	54		0	0 88% Polyester 12% Cotton	SOUTH KOREA	5512-19-0090	\$45.50
2869	32462	8.2	55		0	0 100% Polyester	INDIA	5402-52-2060	\$50.50
2860	32463	14.8	54		0	0 100% Polyester	INDIA	5407-52-2060	\$50.50
2834	32464	15	54	2.5		4.75 60% Cotton 40% Polyester	CHINA	5211.39.0090	\$50.50
2833	32465	11	54	0.63		0.38 52% Polyester 48% Cotton	TAIWAN	5211-49-0090	\$50.50
2833	32466	10	56		0.5	0.5 100% Cotton	CHINA	5209-49-0090	\$45.50
2833	32467	16.1	54	1.63		1.5 67% Rayon 33% Polyester	CHINA	5516-23-0090	\$65.50
2832	32469	20.4	55		0	0 84% Polyester 16% Rayon	CHINA	5810.91.0010	\$65.50
2834	32470	15	54	3.5		3.5 60% Cotton 40% Polyester	CHINA	5211.39.0090	\$55.50
2843	32471	17.8	52		9	10.5 70% Viscose 30% Linen	INDIA	5810.92.9080	\$111.00
2843	32472	22.4	52		3	4.75 70% Viscose 30% Linen	INDIA	5810.92.9080	\$115.50
2843	32473	13.3	52		15	17.5 73% Cotton 27% Rayon	CHINA	5810.92.1000	\$120.50
2843	32474	17.2	51.5		6.5	6 52% Cotton 40% Viscose 8%Linen	INDIA	5810.92.9080	\$120.50
2843	32475	14.1	51		9	17 70% Viscose 30% Linen	INDIA	5810.92.9080	\$120.50
2843	32476	17.1	52	12.25		13 70% Viscose 30% Linen	INDIA	5810.92.9080	\$135.00
2843	32477	15.5	53.5		3.75	7.5 63% Cotton 37% Rayon	CHINA	5810.92.9080	\$120.50
2843	32478	15.2	54	15.75		13.5 31% Viscose 29% Polyester25% Linen 15% Rayon	CHINA	5810.92.9080	\$87.50
2843	32479	17.9	51		6	2 65% Cotton 25% Viscose 10% Linen	INDIA	5810.91.0010	\$118.50
2844	32480	12.6	55		0	0 51% Cotton 42% Polyester7% Acrylic	SOUTH KOREA	5903.90.3090	\$96.50
2844	32481	12.6	55		0	0 51% Cotton 42% Polyester7% Acrylic	SOUTH KOREA	5903.90.3090	\$96.50
2853	32482	16.7	51	6.13		4.25 90% Polyester 10% Rayon	INDIA	5407.52.2060	\$95.00
2853	32483	10.7	51		2	2.13 42% Cotton 35% Rayon 23%Polyester	INDIA	5209.39.0090	\$92.50
2853	32484	17	52	9.38		12.88 88% Polyester 12% Rayon	INDIA	5407.52.2060	\$97.50
2853	32485	13.6	51.5	6.25		3.25 49% Cotton 27% Polyester24% Rayon	INDIA	5209.39.0090	\$92.50
2853	32486	15.6	51.75		6	12.63 70% Polyester 30% Cotton	INDIA	5504.30.3390	\$92.50
2853	32487	19	51.75	6.25		10.25 74% Rayon 26% Linen	INDIA	5516.92.0090	\$100.00
2853	32488	11.5	50		6	5.5 70% Linen 30% Rayon	CHINA	5810-99-9000	\$98.50
2853	32489	11.5	50	23.63		23 70% Linen 30% Rayon	CHINA	5810-99-9000	\$98.50
2863	32490	5.9	57		0	0 100% Polyester	CHINA	5407-52-2040	\$25.00
2864	32491	13.6	55		0	0 53% Polyester 47% Cotton	CHINA	5407-82-0010	\$60.00
2870	32492	10.7	54	2.5		2.25 54% Cotton 46% Polyester	ITALY	5211.49.0020	\$63.00
2873	32493	12.8	54		0	0 84% Polyester 16% Cotton	INDIA	5407.83.0090	\$44.50
2872	32494	12.8	55		0	3.5 84% Polyester 16% Cotton	INDIA	5407.83.0090	\$44.50
2900	32495	8.7	55		0	0 100% Cotton	PAKISTAN	5209.31.6020	\$40.50
2900	32496	11.9	55		0	0.5 100% Cotton	INDIA	5209.41.6020	\$50.50
2871	32497	13.3	55		0	0 100% Linen	CHINA	5309.29.4090	\$63.00
2899	32498	14.5	54		0	0 61% Cotton 39% Polyester	INDIA	5211.39.0040	\$48.50
2891	32500	7.6	54		0	6 100% Polyester	TURKEY	5407.69.3000	\$61.50
2871	32503	9.3	53	1.88		3.88 100% Polyester	TURKEY	5407.69.3000	\$66.50
2873	32504	12.7	54		0	0 100% Polyester	INDIA	5512.29.0010	\$57.50

**Duralee
Retail Price List
(Limited Stock items excluded)**

Prices effective - July 1, 2016

Book	Pattern	Weight	Width	Vertical Repeat	Horizontal Repeat	Content	Origin	Tariff1	Retail
2873	32505	7.3	54		0	0.25 100% Cotton	CHINA	5209.41.6020	\$52.50
2873	32506	14.6	55		0	0 100% Polyester	CHINA	5801.36.0020	\$65.00
2869	32507	13.8	55		1	1 100% Cotton	TURKEY	5209.49.0090	\$68.00
2873	32508	12.1	54		7	7 51% Cotton 49% Polyester	TAIWAN	5211.49.0020	\$62.50
2872	32509	12.6	54		6.5	7 100% Polyester	TAIWAN	5515.12.0090	\$63.00
2872	32510	9.2	54		0	0 100% Cotton	DUBAI	5209.39.0060	\$55.50
2868	32511	11.2	54.5		2.88	6.75 55% Cotton 45% Polyester	TAIWAN	5209.49.0090	\$57.50
2873	32512	9	54		0	0 53% Cotton 47% Polyester	TAIWAN	5211.31.0035	\$44.00
2890	32515	9.5	54		0	4.63 55% Cotton 45% Polyester	TAIWAN	5211.31.0035	\$44.00
2888	32516	10.7	54		0	0 55% Cotton 45% Polyester	TAIWAN	5211.39.0090	\$44.00
2873	32517	11.5	54		0	6.88 52% Cotton 48% Polyester	TAIWAN	5211.49.0049	\$55.50
2873	32518	10	54		0	0 55% Cotton 45% Polyester	TAIWAN	5211.41.0020	\$40.50
2873	32519	13.7	54		0.25	1 67% Cotton 33% Polyester	TAIWAN	5211.39.0090	\$39.50
2873	32520	7.4	54		0	0 100% Polyester	MEXICO	5407.52.2020	\$37.50
2873	32521	10.8	54		0	0 63% Cotton 37% Polyester	TAIWAN	5211.49.0020	\$40.50
2872	32522	12.1	60		0	0 100% Cotton	TURKEY	5209.39.0080	\$42.00
2870	32523	10.4	110		5.75	5.75 55% Polyester 45% Cotton	CHINA	5810.92.9080	\$49.00
2873	32524	7.4	54		8.5	7 100% Polyester	TURKEY	5407.61.9935	\$65.50
2870	32525	15.9	54		0	0 100% Polyester	CHINA	5407.61.9935	\$35.50
2868	32526	7.2	110		6	6 100% Polyester	CHINA	5810.92.9080	\$49.00
2873	32527	13.8	54		0	0 100% Polyester	TURKEY	5407.52.2060	\$40.50
2873	32528	8.1	51.5		4.75	3.25 100% Polyester	INDIA	5810.92.9050	\$79.00
2873	32530	10.7	54		0.5	0.5 52% Polyester 25% Cotton 15% Rayon 8% Linen	TURKEY	5514.30.3390	\$41.00
2867	32531	18.2	54		0	0 100% Polyester	INDIA	5407.52.2040	\$45.00
2873	32532	18.2	54		0	0 100% Polyester	INDIA	5407.52.2040	\$45.00
2872	32533	11.9	57		7.25	6.38 50% Cotton 45% Polyester 5% Linen	CHINA	5407.83.0000	\$64.00
2873	32534	11.9	57		0	0 50% Cotton 45% Polyester 5% Linen	CHINA	5407.83.0000	\$64.00
2872	32535	11.9	57		0	4.75 50% Cotton 45% Polyester 5% Linen	CHINA	5407.83.0000	\$64.00
2870	32536	11.9	57		0	0 50% Cotton 45% Polyester 5% Linen	CHINA	5407.83.0000	\$64.00
2872	32538	11.9	54		0	0 55% Cotton 45% Linen	CHINA	5309.29.4090	\$54.50
2870	32539	5.8	56		0	6.5 100% Polyester	CHINA	5407.53.2060	\$49.50
2869	32540	5.8	56		0	5 100% Polyester	CHINA	5309.29.4090	\$49.50
2873	32542	9.7	55		0	0 100% Polyester	INDIA	5407.52.2060	\$48.50
2873	32544	10.2	54		3.13	1.88 95% Cotton 5% Rayon	CHINA	5810.92.1000	\$58.50
2873	32547	25.8	56		12	13.5 60% Cotton 40% Polyester	CHINA	5211.49.0090	\$63.00
2890	32551	18.6	54		5	3.5 100% Cotton	INDIA	5209.39.0080	\$63.00
2891	32552	6.8	54		0	0 100% Polyester	INDIA	5407.91.2050	\$34.00
2869	32553	7.7	54		0	6 100% Polyester	INDIA	5407.52.2020	\$69.50
2873	32554	12.5	51		14.5	11.75 100% Polyester	CHINA	5407.52.2060	\$57.00
2887	32555	15.5	54		0	4.5 55% Cotton 45% Polyester	TAIWAN	5211.49.0020	\$55.00
2873	32556	17	56		1.25	1.25 100% Polyester	INDIA	5407.53.2060	\$67.50
2891	32557	17.9	55		0	3.5 50% Cotton 50% Polyester	INDIA	5407.82.0090	\$55.00
2873	32558	14.8	58		4.25	4.88 98% Polyester 2% Lycra	INDIA	5407.53.2060	\$70.00
2887	32559	15.2	54		0	0 100% Polyester	INDIA	5407.52.2060	\$59.50
2886	32560	9.4	56		0	3.75 100% Polyester	TURKEY	5407.69.3000	\$58.00
2873	32561	8.1	54		7.63	8.38 100% Polyester	CHINA	5810.92.9080	\$48.00
2867	32563	8.1	54		4	3.75 100% Polyester	CHINA	5810.92.9010	\$49.50
2871	32564	8.1	55		4	3.75 100% Polyester	CHINA	5810.92.9080	\$53.00
2873	32567	8.5	58		3.5	3.75 100% Polyester	CHINA	5407.61.9945	\$45.50
2888	32569	9.6	57		0.63	0.88 100% Polyester	CHINA	5407.61.9955	\$35.50
2869	32570	19.3	54		0.75	0.83 61% Cotton 39% Polyester	CHINA	5211.39.0090	\$59.00
2881	32571	10.4	56		0.38	0.38 100% Cotton	PORTUGAL	5209.41.6020	\$43.50
2881	32572	13.6	55		1.63	1.63 100% Cotton	PORTUGAL	5209.41.6020	\$50.50
2881	32573	10.4	54		0.5	0.5 100% Cotton	PORTUGAL	5209.41.6020	\$43.50
2881	32574	10.4	56		3.25	3.5 100% Cotton	PORTUGAL	5209.41.6020	\$43.50
2881	32575	10.4	56		0	6.88 100% Cotton	PORTUGAL	5209.41.6020	\$43.50
2882	32576	20.3	54		0	0 100% Linen	BRAZIL	5309.19.0090	\$98.50
2891	32577	6.4	54		0	0 60% Polyester 40% Viscose	INDIA	5407.91.9050	\$53.50

**Duralee
Retail Price List
(Limited Stock items excluded)**

Prices effective - July 1, 2016

Book	Pattern	Weight	Width	Vertical Repeat	Horizontal Repeat	Content	Origin	Tariff1	Retail
2886	32578	19.6	54		7	14.75 100% Polyester	CHINA	5407.69.4060	\$72.50
2891	32580	15	54	1.75		2 60% Rayon 40% Polyester	CHINA	5516.23.0090	\$52.00
2891	32581	20.8	54	0.38		0.5 70% Rayon 30% Polyester	CHINA	5516.23.0090	\$52.00
2891	32582	24.8	54		13	14.5 100% Polyester	CHINA	5407.53.2060	\$62.50
2891	32583	15	54		6.5	10.25 100% Polyester	CHINA	5407.53.2060	\$57.50
2888	32584	14.4	54		5.5	1.5 100% Polyester	CHINA	5407.69.4060	\$52.00
2887	32585	19.6	54		4	1 34% Polyester 34% Rayon 32% Cotton	CHINA	5407.83.0090	\$52.00
2888	32586	15.9	54		14	7.25 100% Polyester	CHINA	5407.69.4060	\$67.50
2887	32587	14.4	54		14	15 60% Rayon 40% Polyester	CHINA	5516.23.0090	\$52.00
2886	32588	15.6	54		1.5	1.5 100% Polyester	CHINA	5801.36.0020	\$52.00
2891	32589	8.3	55		0	2.38 100% Polyester	TURKEY	5407.53.2060	\$72.00
2927	32590	7.8	54		0	0 59% Polyester 41% Cotton	INDIA	5407.82.0090	\$49.50
2890	32591	12	57		1	1 50% Cotton 50% Polyester	CHINA	5211.19.0019	\$57.50
2888	32592	6.3	54	12.38		6 55% Cotton 45% Polyester	TAIWAN	5211.49.0090	\$50.50
2890	32593	11.8	54		2.5	2.25 100% Cotton	PORTUGAL	5209.39.0080	\$90.50
3045	32594	10.4	54		0	0 100% Cotton Sateen	INDIA	5208.39.2020	\$34.00
2891	32595	8.8	57		0	0 100% Polyester	CHINA	5407.52.2060	\$52.50
2891	32596	12.8	56		0	0 87% Polyester 13% Linen	CHINA	5407.52.2040	\$68.00
2889	32597	5	54.5	18.5		14 100% Polyester	TURKEY	5407.69.3000	\$67.50
2890	32598	8.3	55	2.38		2.38 100% Polyester	TURKEY	5407.53.2060	\$74.00
2889	32599	7.5	54		0	0 100% Polyester	USA	5407.52.2060	\$45.50
2888	32601	7.8	54		0	0 63% Cotton 37% Polyester	TAIWAN	5210.39.6090	\$32.50
2890	32602	10.1	54		3.5	2 51% Cotton 49% Polyester	TAIWAN	5211.31.0035	\$44.00
2890	32604	13	54		0	0 60% Linen 40% Rayon	CHINA	5309.29.3070	\$45.50
2890	32605	18.7	54		16	13.75 71% Polyester 29% Cotton	INDIA	5407.82.0090	\$47.50
2890	32606	18.7	54		0	6.75 71% Polyester 29% Cotton	INDIA	5407.83.0090	\$47.50
2890	32607	17.7	54		0	0 56% Cotton 44% Polyester	INDIA	5309.29.4010	\$42.50
2889	32608	18.5	54		0	0 56% Cotton 44% Polyester	INDIA	5211.39.0090	\$42.50
2890	32609	7.3	54		0	0 100% Polyester	INDIA	5407.53.2020	\$35.00
2891	32610	19.6	54		0	0 80% Polyester 20% Cotton	INDIA	5407.82.0090	\$45.00
2890	32611	17	54		0	0 100% Polyester	CHINA	5512.19.0090	\$45.50
2886	32612	17.7	54		0	2.75 56% Cotton 44% Polyester	INDIA	5211.39.0090	\$42.50
2891	32613	15	51	7.75		7.75 80% Cotton 20% Polyester	CHINA	5211.39.0090	\$55.00
2948	32615	8	54		0	0 55% Linen 45% Cotton	CHINA	5309.21.4010	\$51.00
2891	32616	12.9	55		0	0 100% Polyester	CHINA	5407.53.2060	\$39.50
2890	32617	20.4	56	0.38		3.75 100% Polyester	CHINA	5515.12.0090	\$64.00
2890	32618	18.3	55		0	3.38 70% Linen 30% Cotton	CHINA	5309.29.4010	\$67.50
2890	32620	18.6	54		7	6.75 100% Cotton	INDIA	5209.39.0080	\$63.00
2890	32621	12	55	15.5		13.88 100% Polyester	TURKEY	5407.94.2090	\$73.50
2889	32622	24.7	57	11.75		7 100% Polyester	CHINA	5407.53.2060	\$65.50
2887	32623	15.3	55		0	0 56% Cotton 44% Polyester	CHINA	5211.49.0020	\$45.50
2891	32624	14.9	57	6.25		2.5 100% Polyester	CHINA	5407.53.2060	\$55.50
2889	32625	23.6	57		6	3.75 100% Polyester	CHINA	5407.53.2060	\$60.50
2889	32626	18.1	56	1.75		1.13 100% Polyester	CHINA	5407.53.2060	\$60.50
2889	32627	12.4	55	3.25		3.25 70% Polyester 30% Rayon	INDIA	5407.93.2090	\$65.50
2887	32628	5.6	54		0	0 100% Polyester	INDIA	5407.61.9930	\$30.00
2890	32629	17	54		0	1.5 87% Cotton 13% Rayon	TURKEY	5209.49.0090	\$70.50
2890	32630	15.9	54		0	6.88 56% Cotton 44% Polyester	TAIWAN	5211.49.0020	\$55.00
2890	32631	18	54	2.25		1.13 41% Cotton 40% Polyester 19% Acrylic	TURKEY	5801.36.0020	\$52.50
2928	32632	26.3	54		0	0 60% Polyester 40% Rayon	INDIA	5515.11.0090	\$72.50
2891	32633	12.7	54		0	0 72% Polyester 16% Cotton 12% Rayon	INDIA	5407.83.0090	\$61.00
2890	32634	19.2	54	6.88		9.25 70% Cotton 30% Polyester	INDIA	5211.39.0090	\$50.00
2891	32635	16.3	56		0	3 91% Cotton 9% Linen	CHINA	5209.49.0090	\$57.00
2885	32636	15.5	58		0	4 85% Cotton 15% Linen	CHINA	5209.49.0090	\$57.50
2888	32637	15.5	56	5.13		6 94% Cotton 6% Linen	CHINA	5209.59.0090	\$57.50
2891	32638	24.6	55		0	0 41% Polyester 38% Viscose 21% Cotton	INDIA	5801.36.0020	\$77.50
2888	32639	16.3	56		0	4.88 90% Cotton 10% Linen	CHINA	5209.41.6020	\$57.00
2891	32640	16.4	51	7.25		9 88% Polyester 12% Cotton	INDIA	5810.92.10	\$74.00

**Duralee
Retail Price List
(Limited Stock items excluded)**

Prices effective - July 1, 2016

Book	Pattern	Weight	Width	Vertical		Content	Origin	Tariff1	Retail
				Repeat	Repeat				
2891	32641	21.9	51	4.25	4.5	100% Polyester	INDIA	5810.92.10	\$72.00
2890	32642	10.4	55	0.25	7	70% Cotton 30% Polyester	TURKEY	5801.36.0010	\$58.50
2886	32643	10.4	55	0.25	7	35% Cotton 35% Viscose 30% Polyester	TURKEY	5801.36.0010	\$58.50
2899	32644	7.6	55	0	0	46% Polyester 28% Viscose 26% Lurex	INDIA	5407.93.2090	\$74.00
2900	32645	11.9	55	0.13	0	100% Cotton	INDIA	5209.41.6020	\$45.50
2900	32646	11.9	55	0	13.5	100% Cotton	INDIA	5209.41.6020	\$50.50
2900	32647	8.7	55	13.5	13.5	100% Cotton	PAKISTAN	5209.31.6020	\$40.50
2900	32648	8.7	55	13.5	13.5	100% Cotton	PAKISTAN	5209.31.6020	\$40.50
2900	32649	8.7	55	0	0	100% Cotton	PAKISTAN	5209.31.6020	\$40.50
2900	32650	11.9	55	0	0.5	100% Cotton	INDIA	5209.41.6020	\$50.50
2915	32651	8.7	55	0	0	55% Linen 45% Viscose	CHINA	5309.29.4010	\$50.50
2915	32652	15.8	54	0	0	55% Linen 45% Rayon	CHINA	5309.29.4010	\$50.50
2916	32653	3.7	54	0	0	100% Polyester	INDIA	5407.52.2020	\$29.50
2918	32654	14.6	54	0	0	58% Polyester 42% Viscose	INDIA	5407.93.2090	\$58.50
2918	32655	6.2	54	0	0	68% Polyester 32% Viscose	INDIA	5407.93.2010	\$72.50
2919	32656	9.9	55	0	0	54% Cotton 46% Polyester	INDIA	5211.39.0090	\$45.00
2928	32657	14.1	56	0	0	100% Polyester	INDIA	5407.52.2060	\$48.00
2928	32658	13	54	0.38	0.38	71% Polyester 29% Viscose	INDIA	5407.53.2060	\$40.50
2928	32659	11.2	52	4	4	90% Polyester 10% Viscose	INDIA	5407.92.2090	\$99.00
2928	32660	16.1	56	0	2	46% Viscose 27% Cotton 27% Polyester	CHINA	5514.23.0090	\$50.00
2927	32661	19	54	15.5	14	52% Cotton 48% Polyester	CHINA	5211.49.0020	\$67.50
2926	32662	12.3	54	7	7.5	100% Polyester	TURKEY	5407.93.2090	\$60.50
2926	32663	7.5	54	0	2.75	100% Cotton	TAIWAN	5209.41.6020	\$62.50
2927	32664	14.2	54	1.5	1.75	65% Polyester 35% Cotton	CHINA	5903.10.3000	\$80.00
2928	32665	6.2	57	0	0	100% Polyester	CHINA	6001.92.0040	\$45.50
2927	32666	8.9	54	9.5	7.25	100% Polyester	TURKEY	5407.53.2040	\$65.50
2928	32667	18	54	11	9.88	59% Polyester 41% Linen	INDIA	5407.93.2090	\$65.50
2928	32668	20.2	57	0	0	100% Polyester	CHINA	5407.61.9000	\$35.50
2928	32669	10.9	54	9	10	88% Viscose 12% Polyester	INDIA	5407.61.9000	\$80.50
2928	32670	17.9	57	5.88	3.75	100% Polyester	CHINA	5407.61.9955	\$33.00
2928	32671	20.9	55	0	0	100% Polyester	INDIA	5407.61.9935	\$47.50
2928	32672	13.5	54	1.5	2.75	75% Cotton 25% Polyester	TAIWAN	5211.49.0049	\$58.50
2928	32674	21.7	56	0.25	0.63	51% Polyester 39% Rayon 10% Linen	CHINA	5515.11.0005	\$74.00
2928	32675	10.6	55	0.38	0.25	100% Cotton	PORTUGAL	5209.41.6020	\$43.50
2928	32676	18.4	54	2.38	1.5	69% Cotton 31% Polyester	CHINA	5211.49.0020	\$59.00
2928	32677	18.4	54	3.13	2.75	69% Cotton 31% Polyester	CHINA	5407.93.2090	\$59.00
2928	32678	27.9	54	0	0	100% Linen	CHINA	5309.29.4090	\$116.50
2928	32679	13.8	51	5.5	5.5	40% Polyester 29% Linen 29% Rayon 2% Cotton	CHINA	5810.99.9000	\$75.50
2927	32680	12	54	0	6.75	52% Cotton 48% Polyester	TAIWAN	5211.41.0049	\$55.50
2928	32681	20.1	54	0	0	55% Rayon 45% Polyester	TAIWAN	5408.32.9010	\$60.00
2926	32682	19.3	57	1.75	1.63	58% Cotton 42% Linen	CHINA	5212.14.6090	\$70.50
2928	32683	19.6	54	14.5	13.5	60% Cotton 40% Polyester	CHINA	5211.39.0090	\$65.50
2927	32684	18.5	56	0.75	0	100% Polyester	CHINA	5407.53.2060	\$69.00
2928	32685	22.3	55	3.75	4.5	34% Cotton 34% Rayon 32% Polyester	CHINA	5212.24.6030	\$60.50
2928	32686	21	54	1.5	1.5	67% Rayon 33% Polyester	CHINA	5516.23.0090	\$65.50
2928	32687	11.5	56	1.13	0.88	100% Polyester	CHINA	5407.93.2020	\$46.00
2928	32688	21.3	55	3.63	3.63	70% Cotton 30% Polyester	CHINA	5211.49.0090	\$65.50
2928	32689	22	57	8.25	2.5	71% Polyester 17% Linen 12% Acrylic	CHINA	5407.93.2090	\$55.50
2928	32690	16.7	56	0.75	0.75	100% Polyester	TURKEY	5407.69.3000	\$72.50
2927	32691	9.5	52	15.5	17.38	87% Rayon 13% Polyester	INDIA	5516.13.0000	\$105.00
2926	32692	17.7	54	1.25	1.25	58% Polyester 42% Cotton	CHINA	5801.36.0020	\$50.50
2927	32694	11	51	12.5	8.5	90% Polyester 10% Viscose	INDIA	5407.92.2090	\$91.50
2936	32695	7.6	51	5.75	9.75	58% Cotton 25% Polyester 17% Linen	CHINA	5810.91.0010	\$108.50
2940	32696	6.9	54	0	0.75	100% Cotton	INDIA	5208.49.4090	\$38.00
2941	32697	14.6	52	9.38	13	71% Polyester 29% Viscose	INDIA	5407.52.2040	\$116.50
2940	32698	6.9	54	0	0	100% Cotton	INDIA	5208.49.4090	\$38.00
2940	32699	12.8	55	0.5	0.5	57% Cotton 43% Polyester	INDIA	5210.49.4090	\$45.50
2940	32700	12.8	55	3	2.75	57% Cotton 43% Polyester	INDIA	5210.49.4090	\$45.50

**Duralee
Retail Price List
(Limited Stock items excluded)**

Prices effective - July 1, 2016

Book	Pattern	Weight	Width	Vertical	Horizontal	Content	Origin	Tariff1	Retail
				Repeat	Repeat				
2940	32701	12.8	55		0	0.5 57% Cotton 43% Polyester	INDIA	5210.49.4090	\$45.50
2940	32702	12.8	55		0	2.75 57% Cotton 43% Polyester	INDIA	5210.49.4090	\$45.50
2940	32703	19.2	55	7.25		7.5 100% Cotton	CHINA	5209.49.0020	\$50.50
2941	32704	10.3	53		9.5	7.88 60% Polyester 40% Cotton	INDIA	5407.61.9000	\$90.50
2941	32705	10.3	53	4.75		4.75 60% Polyester 40% Cotton	INDIA	5407.61.9000	\$90.50
2941	32706	10.3	53		9.5	8.63 60% Polyester 40% Cotton	INDIA	5407.61.9000	\$90.50
2941	32707	14.2	52		9	17.25 42% Polyester 39% Cotton19% Viscose	INDIA	5211.31.0090	\$111.50
2941	32708	15.5	52		9	8.75 56% Polyester 44% Cotton	INDIA	5512.19.0090	\$111.50
2941	32709	16.2	52	6.25		3.25 58% Polyester 42% Cotton	INDIA	5514.23.0090	\$111.50
2941	32710	16.2	52		9	13 57% Polyester 43% Cotton	INDIA	5514.23.0090	\$111.50
2941	32711	17.6	52.5		9	5.25 66% Polyester 34% Viscose	INDIA	5407.92.2090	\$96.50
2941	32712	12.2	52	22.5		12.25 80% Cotton 20% Polyester	CHINA	5810.91.0010	\$120.50
2941	32713	20.3	51	0.5		4.25 87% Polyester 13% Viscose	INDIA	5407.52.2060	\$105.00
2945	32714	6	56		0	0 60% Cotton 40% Polyester	SOUTH KOREA	5210.31.6040	\$29.00
2946	32715	10.9	55		9.5	9.63 67% Polyester 33% Cotton	INDIA	5407.83.0090	\$61.50
2946	32716	10.9	55	2.38		6.38 67% Polyester 33% Cotton	INDIA	5407.83.0090	\$60.50
2946	32717	9.8	54		12	7 78% Polyester 22% Viscose	INDIA	5407.93.2010	\$55.50
2946	32718	10.5	55	13.75		17 64% Cotton 36% Polyester	INDIA	5211.39.0090	\$60.50
2952	32719	10.2	54	6.88		4.75 59% Polyester 41% Viscose	INDIA	5407.93.2090	\$66.50
2946	32720	9.8	54		1	0.88 78% Polyester 22% Viscose	INDIA	5407.93.2010	\$71.50
2946	32721	10.1	55	2.38		2.5 66% Polyester 34% Linen	INDIA	5407.93.2090	\$75.00
2946	32722	10.3	54		0	0 63% Polyester 20% Cotton17% Viscose	INDIA	5407.82.0090	\$46.50
2946	32723	13.3	55	3.13		0 66% Polyester 19% Linen 15% Cotton	INDIA	5407.93.2090	\$71.50
2946	32724	8.1	54		0	0 68% Cotton 32% Polyester	TAIWAN	5210.39.6090	\$40.50
2946	32725	10.4	54		0	0 62% Cotton 38% Polyester	INDIA	5211.39.0090	\$50.50
2946	32726	14.2	55		1	1 68% Polyester 32% Cotton	INDIA	5407.83.0090	\$56.50
2946	32728	9.2	56.5	12.13		9.5 67% Polyester 33% Cotton	INDIA	5407.83.0090	\$56.50
2946	32729	10.8	55	9.88		14.13 67% Polyester 33% Cotton	INDIA	5407.83.0090	\$56.50
2942	32730	5	54		0	0 100% Polyester	INDIA	5401.61.9930	\$35.00
2946	32731	12.7	55	9.13		1.38 58% Polyester 42% Cotton	INDIA	5407.82.0090	\$61.50
2952	32732	10.6	56		0	6.13 100% Linen	CHINA	5309.19.0010	\$76.50
2952	32733	11.7	55		0	6.88 100% Linen	CHINA	5309.19.0010	\$86.50
2952	32734	12	54		0	0 100% Polyester FR	TAIWAN	5515.12.9000	\$40.50
2951	32735	15	54	9.25		10 100% Polyester	CHINA	5407.69.4060	\$65.50
2952	32736	12.7	54		2	2 100% Polyester	CHINA	5407.69.4060	\$50.50
2952	32737	9	55		7	6.75 100% Cotton	TURKEY	5209.41.6020	\$72.50
2952	32738	7	54	0.25		0.25 100% Cotton	PORTUGAL	5209.49.0090	\$57.50
2952	32739	6	55	0.75		0.5 100% Cotton	TURKEY	5208.42.3000	\$57.50
2952	32740	18	54	7.75		4.5 72% Cotton 28% Polyester	CHINA	5212.24.6030	\$50.50
2952	32741	8.5	54		0	54 70% Cotton 30% Polyester	USA	5210.59.6090	\$55.00
2949	32746	14.5	54		0	0 100% Polyester	INDIA	5512.12.0090	\$50.50
2952	32747	8	54		0	0 55% Linen 45% Cotton	CHINA	5309.29.0000	\$51.00
2952	32748	18.3	54	6		4.5 69% Cotton 31% Polyester	CHINA	5212.24.6030	\$58.50
2952	32749	22	56		0	3.5 100% Polyester	CHINA	5407.93.2090	\$53.50
2952	32750	10.9	55		1	1 70% Cotton 30% Polyester	CHINA	5211.49.0020	\$58.50
2952	32751	7.6	58	4.88		3.88 100% Polyester	CHINA	5407.61.9955	\$45.50
2951	32752	11.3	54	1.13		0.88 51% Rayon 49% Polyester	CHINA	5516.23.0090	\$45.50
2952	32753	19.4	55		0	0 100% Polyester	CHINA	5407.52.4060	\$50.50
2952	32754	16.7	57	0.88		0.88 69% Cotton 31% Polyester	CHINA	5211.39.0090	\$55.50
2952	32755	10.8	54	6.75		4.5 55% Cotton 45% Polyester	TAIWAN	5211.49.0090	\$50.50
2949	32756	9.8	52	3.75		3.25 55% Linen 45% Rayon	CHINA	5810.99.9000	\$67.00
2950	32757	10.5	55	0.5		0.63 51% Cotton 49% Polyester	TAIWAN	5211.49.0090	\$50.50
2952	32758	17.4	54		0	0 97% Cotton 3% Lurex	INDIA	5209.39.0090	\$62.50
2952	32759	14.6	54		0	0 100% Polyester	INDIA	5409.52.2040	\$50.50
2952	32760	17.1	54		0	0 100% Cotton	INDIA	5209.39.0080	\$63.00
2949	32761	12.5	55		0	3.38 70% Polyester 30% Cotton	INDIA	5514.30.3310	\$62.00
2949	32762	14.8	51		9	6.5 82% Polyester 18% Viscose	INDIA	5407.92.2010	\$92.50
2952	32763	11.1	51		9	17 62% Polyester 23% Cotton15% Viscose	INDIA	5514.23.0090	\$110.50

**Duralee
Retail Price List
(Limited Stock items excluded)**

Prices effective - July 1, 2016

Book	Pattern	Weight	Width	Vertical Repeat	Horizontal Repeat	Content	Origin	Tariff1	Retail
2952	32764	17.9	56		0	7 100% Cotton	TURKEY	5209.49.0090	\$65.50
2952	32765	6.6	52.5	4.5	2.63	56% Cotton 44% Polyester	INDIA	5210.39.4090	\$86.50
2952	32766	8.5	51	6.25	8.5	56% Polyester 44% Cotton	INDIA	5210.39.4090	\$91.50
2952	32767	6.6	52	1	6.75	56% Cotton 44% Polyester	INDIA	5210.39.4090	\$86.50
2952	32768	18.7	55	3.25	1.75	69% Cotton 31% Polyester	TURKEY	5211.49.0020	\$67.50
2964	32769	20	52.5	6	7.5	55% Cotton 45% Polyester	INDIA	5211390000	\$131.00
2966	32770	13.3	58	0	0	100% Cotton	SOUTH KOREA	5209310000	\$48.50
2965	32771	7.6	52	17	22	58% Cotton 25% Polyester17% Linen	CHINA	5211310000	\$137.00
2973	32772	10.5	54	0	0	70% Cotton 30% Polyester	TAIWAN	5211390000	\$43.50
2974	32773	19.8	55	9.5	10.5	75% Viscose 25% Linen	INDIA	5810920000	\$117.50
2974	32774	0	52	6	10.5	100% Polyester	INDIA	5407619900	\$95.50
2974	32775	17.6	54	4.5	4	34% Viscose 28% Linen 28%Polyester 10% Rayon	CHINA	5810910000	\$75.50
2974	32776	17.6	54	6	6	30% Viscose 28% Polyester26% Linen 16% Rayon	CHINA	5810910000	\$85.50
2974	32777	17.6	54	5.25	3.88	32% Viscose 30% Polyester26% Linen 12% Rayon	CHINA	5810910000	\$70.50
2974	32779	19.1	52	6.38	10.38	77% Polyester 23% Linen	INDIA	5407920000	\$96.50
2974	32780	0	52	6	8.5	60% Polyester 40% Cotton	INDIA	5810920000	\$120.50
2974	32781	10.8	51	8	8.5	88% Cotton 12% Viscose	INDIA	5209110000	\$90.50
2974	32782	13.7	50	15.25	25	50% Cotton 50% Lurex	INDIA	5211190000	\$110.50
2974	32783	18.5	51.5	9	12.88	43% Polyester 39% Cotton18% Viscose	INDIA	5514239000	\$110.50
2974	32784	17.9	52	3	2.63	100% Polyester	INDIA	5407529029	\$100.00
2974	32785	28.3	52	10.38	12.75	69% Polyester 31% Cotton	INDIA	5407829900	\$105.50
2974	32786	33.2	52	10.5	5.25	100% Polyester	INDIA	5407529029	\$100.50
2974	32787	19.9	52	4.38	4.25	37% Viscose 21% Cotton 21% Linen 21% Polyester	INDIA	5515999900	\$96.50
2975	32788	5.5	54	0	0	100% Linen	USA	5309190000	\$43.50
2975	32789	5.5	55	0	0	100% Linen	USA	5309190000	\$48.50
2965	32792	12.1	55	28	14	60% Viscose 20% Cotton 20% Polyester	TURKEY	5516.23.0090	\$94.00
2965	32793	11.4	56	24.25	18.25	74% Cotton 26% Polyester	TURKEY	5210390000	\$72.50
3000	32794	16.7	56	6	6	100% Cotton	INDIA	5209.39.0040	\$71.50
3000	32795	21.7	54	3.5	3.75	100% Cotton	INDIA	5209.39.0040	\$74.50
3000	32796	23	54	3.5	6.25	100% Cotton	INDIA	5209.39.0040	\$73.00
3000	32797	17	54	4.25	5	100% Cotton	INDIA	5209.39.0040	\$68.00
3000	32798	17	56	4.75	4.63	100% Cotton	INDIA	5209.39.0040	\$67.50
3000	32799	18.7	54	6	4.5	100% Cotton	INDIA	5209.39.0040	\$64.00
3000	32800	10.4	56	3.38	3.38	100% Cotton	INDIA	5209.39.0040	\$55.00
3000	32801	20.8	54	0.38	0.38	100% Cotton	INDIA	5209.39.0040	\$74.50
3000	32802	22.8	54	0.38	0.5	100% Cotton	INDIA	5209.39.0040	\$69.00
3000	32803	12.6	54	0.63	0.75	100% Cotton	INDIA	5209.39.0040	\$64.00
3001	32804	17.7	54	0	6	100% Cotton	INDIA	5209.39.0040	\$60.00
3001	32805	13.5	54	0	4.5	100% Cotton	INDIA	5209.39.0040	\$53.50
3001	32806	13.3	54	0	5	100% Cotton	INDIA	5209.39.0040	\$58.50
3001	32807	15.1	54	0	4.25	100% Cotton	INDIA	5209.39.0040	\$74.50
3001	32809	10.4	56	0	3	100% Cotton	INDIA	5209.39.0040	\$55.00
2986	32810	13.2	54	0	0	51% Cotton 49% Polyester	TAIWAN	5211.39.0090	\$45.00
2986	32811	11.2	54	0	0	55% Cotton 45% Polyester	TAIWAN	5211.49.0020	\$45.00
2986	32812	14.4	54	0	0	100% Polyester	INDIA	5407.53.2060	\$50.00
2988	32813	17.5	54	0	0	100% Linen	CHINA	5309.19.0010	\$92.00
2989	32814	18	54	0	0	100% Cotton	USA	5209.39.0090	\$63.50
2997	32815	19.2	54	0	0	100% Polyester	INDIA	5512.19.0090	\$65.00
2996	32816	7.2	54	0	6.88	100% Polyester	TURKEY	5407.69.3000	\$65.00
2996	32817	9.2	51.75	6.25	6.5	100% Polyester	INDIA	5407.69.2010	\$100.00
2997	32818	14.1	54	9	9	55% Cotton 45% Polyester	TAIWAN	5211.39.0090	\$50.00
2996	32819	19.6	55	0	0	100% Cotton	INDIA	5209.41.6020	\$55.00
2997	32820	15.4	54	10	4.5	100% Cotton	TAIWAN	5209.39.0000	\$55.00
2997	32821	8.1	57	3.38	7.25	70% Rayon 30% Polyester	CHINA	5801.36.0000	\$60.00
2997	32822	19.3	54	2.25	2.25	100% Polyester	INDIA	5407.61.9935	\$90.00
2997	32823	22.7	55	0	0	100% Polyester	CHINA	5407.52.2060	\$35.00
2997	32824	20.2	56	0	0	100% Polyester	CHINA	5512.19.0090	\$40.00
2996	32825	11.8	54	6.38	13.5	70% Cotton 30% Polyester	INDIA	5407.82.0090	\$68.50

**Duralee
Retail Price List
(Limited Stock items excluded)**

Prices effective - July 1, 2016

Book	Pattern	Weight	Width	Vertical Repeat	Horizontal Repeat	Content	Origin	Tariff1	Retail
2997	32826	14.2	54	3.5	3.5	61% Rayon 39% Polyester	CHINA	5516.23.0090	\$62.50
2997	32827	12.4	54	1.13	0.63	45% Polyester 44% Rayon 11% Cotton	CHINA	5407.91.2090	\$54.00
2997	32828	14.6	54	0.25	0.25	95% Polyester 5% Cotton	CHINA	5407.53.2060	\$68.50
2997	32829	15.8	54	1	1	66% Cotton 34% Linen	CHINA	5309.29.4010	\$73.50
2997	32830	9.5	54	0	3.38	100% Cotton	PORTUGAL	5209.49.0090	\$44.00
2997	32831	16.2	54	4	3.5	100% Polyester	INDIA	5515.12.0090	\$63.50
2997	32832	20.9	57	1.75	3	69% Cotton 31% Polyester	CHINA	5211.49.0020	\$55.00
2995	32833	17.4	56	0.13	4.63	100% Cotton	TURKEY	5209.49.0090	\$70.00
2997	32834	24.4	57	0	0	55% Polyester 25% Rayon 20% Linen	CHINA	5515.11.0090	\$55.00
2997	32835	17.3	52	4.38	4.75	76% Polyester 18% Cotton6% Linen	INDIA	5514.21.0090	\$105.00
2997	32836	12.2	55	0	0.25	100% Cotton	PORTUGAL	5209.49.0090	\$45.00
2997	32837	20	55	2.75	2.25	34% Cotton 34% Rayon 32%Polyester	CHINA	5212.24.6030	\$65.00
2997	32839	13.7	54	15.5	13.75	100% Polyester	INDIA	5407.69.2060	\$76.50
2996	32840	8.6	54	0.5	0.63	100% Polyester	CHINA	5512.19.0090	\$50.00
2997	32841	8.4	57	0	0	100% Polyester	CHINA	5407.61.9935	\$50.00
2997	32842	11.8	54	0	0	25% Cotton 25% Linen 25%Polyester 25% Rayon	INDIA	5516.92.0090	\$65.00
2996	32843	14	53	11.63	13.25	60% Polyester 30% Acrylic10% Linen	CHINA	5515.19.0090	\$85.00
2997	32844	12.4	54	0	0	100% Cotton	PAKISTAN	5209.39.0090	\$50.00
3000	32845	20.8	54	0.75	1	100% Cotton	INDIA	5209.39.0040	\$74.50
3001	32846	11.9	54	2.25	1.75	100% Cotton	INDIA	5209.39.0040	\$53.50
3001	32847	19	54	0	9	100% Cotton	INDIA	5209.39.0040	\$66.50
3001	32848	7.8	56	0	1.75	100% Cotton	INDIA	5209.39.0040	\$51.00
3004	32850	11.5	55	0	0	63% Polyester 35% Viscose2% Nylon	CHINA	5407.93.2090	\$62.50
3002	32851	7.5	51.5	11.5	17	100% Polyester	INDIA	5810.92.9080	\$95.00
3002	32852	7.9	50	15	17	100% Polyester	INDIA	5810.92.9080	\$95.00
3002	32853	21.6	51	15.25	12.75	69% Cotton 28% Viscose 3%Polyester	INDIA	5209.39.0090	\$100.00
3002	32854	15.4	51.5	6.38	26	56% Polyester 44% Cotton	INDIA	5410.92.9000	\$75.00
3001	32855	13.3	56	0	5.5	100% Cotton	INDIA	5209.39.0040	\$60.00
3010	32856	14.4	56	0	0	54% Polyester 32% Cotton11% Viscose 3% Linen	TURKEY	5407.83.0090	\$75.00
3010	32857	11.5	54	0	3	64% Polyester 19% Cotton11% Linen 6% Viscose	TURKEY	5407.93.2090	\$75.00
3010	32858	11.8	54	0	1	50% Polyester 29% Cotton11% Linen 10% Viscose	TURKEY	5514.30.3390	\$75.00
3010	32859	13.3	54	4.5	5.5	82% Polyester 18% Cotton	INDIA	5407.93.2090	\$81.50
3010	32860	10.5	55	13.5	13.25	64% Cotton 36% Polyester	INDIA	5211.49.0090	\$65.00
3010	32861	11	55	5	4.75	62% Polyester 30% Cotton8% Lycra	INDIA	5407.93.2090	\$75.00
3010	32862	11.1	54	6.25	13.63	80% Polyester 20% Cotton	INDIA	5515.12.0090	\$66.50
3010	32863	10.1	55	2.5	2.38	66% Polyester 34% Linen	INDIA	5407.93.2090	\$75.00
3010	32864	10.7	55	0	0	56% Cotton 44% Polyester	TAIWAN	5211.49.0020	\$51.50
3010	32865	10.3	54	0	0	63% Polyester 20% Cotton17% Viscose	INDIA	5407.82.0090	\$46.50
3010	32866	14.2	55	1	1	68% Polyester 32% Cotton	INDIA	5407.83.0090	\$56.50
3010	32867	13.3	54	2	1.75	82% Polyester 18% Cotton	INDIA	5515.12.0090	\$71.50
3010	32868	12.3	54	0	0	79% Polyester 21% Cotton	INDIA	5515.12.0090	\$61.50
3010	32869	11.3	55	0	0	100% Polyester	INDIA	5407.61.9955	\$61.50
3015	32870	12	51	23.5	20.5	52% Linen 36% Cotton 12%Rayon	CHINA	5516.93.0020	\$108.50
3014	32871	11.9	52	22	22	45% Linen 37% Cotton 18%Rayon	CHINA	5516.93.0020	\$79.50
3015	32872	7.2	57	28	13.88	70% Polyester 30% Cotton	TURKEY	5407.03.0090	\$122.00
2759	36101	13.3	55	8.25	4.63	60% Cotton 40% Polyester	CHINA	5211.49.0020	\$49.50
2767	36119	16	56	0	0	100% Polyester	CHINA	5906-99-2500	\$52.00
2778	36121	20.3	54	25	27	100% Polyester	CHINA	5209.39.0090	\$93.00
2778	36122	20.3	54	6	7	100% Polyester	CHINA	5801.36.0010	\$93.00
2811	36127	21.6	56	0	0	100% Polyester	CHINA	5801.36.0010	\$63.50
2788	36130	15.1	54	0	0.25	63% Cotton 37% Polyester	CHINA	5211.49.0020	\$49.50
2787	36131	25.8	54	0.38	0.5	60% Cotton 40% Polyester	CHINA	5211.49.0020	\$59.00
2810	36132	13.6	56	0.75	0.75	36% Polyester 33% Rayon 31% Cotton	CHINA	5515.11.0090	\$44.50
2788	36136	17.4	54.5	3.38	3.38	72% Cotton 28% Polyester	CHINA	5211.49.0090	\$69.00
2833	36138	23.3	58	0.5	0.5	89% Polyester 11% Cotton	CHINA	5801.36.0020	\$64.00
2818	36139	18.3	57	1.25	1.25	61% Cotton 39% Polyester	CHINA	5211-39-0090	\$50.50
2818	36140	13.6	55	5.25	2.5	70% Cotton 30% Polyester	CHINA	5211.49.0020	\$65.50
2818	36141	16.8	55	9.5	9.5	68% Polyester 32% Rayon	CHINA	5407-93-2090	\$65.50

**Duralee
Retail Price List
(Limited Stock items excluded)**

Prices effective - July 1, 2016

Book	Pattern	Weight	Width	Vertical		Content	Origin	Tariff1	Retail
				Repeat	Repeat				
2818	36142	16.7	56		9.5	9.5 68% Cotton 32% Rayon	CHINA	5407-93-2090	\$65.50
2818	36143	13.1	57	13.25		28.25 56% Acrylic 44% Polyester	CHINA	5515.29.0090	\$50.50
2818	36144	10.8	54	12.63		6.75 100% Cotton	CHINA	5209.59.0060	\$60.50
2819	36146	16.1	54	0.38		0.38 57% Cotton 43% Polyester	CHINA	5211.49.0020	\$50.50
2819	36147	20.1	55	0		0 100% Polyester	CHINA	5801.36.0040	\$65.50
2834	36150	18.2	55	0		0 50% Polyester 50% Rayon	CHINA	5516.23.0040	\$54.00
2833	36151	22.7	54	1		1 65% Polyester 35% Polypropylene	CHINA	5515-12-0090	\$40.50
2832	36152	17.8	54	11		1.75 100% Polyester	CHINA	5801-36-0020	\$45.50
2831	36157	24.1	55	4.38		4.5 66% Polyester 34% Rayon	CHINA	5801-26-0020	\$75.50
2834	36158	18.3	55	6.75		6.75 44% Rayon 33% Polyester 23% Cotton	CHINA	5801.36.0020	\$60.50
2834	36159	22.7	54	14		13.25 75% Rayon 25% Polyester	CHINA	5801.36.0020	\$75.50
2833	36160	15.8	54	15		13.5 60% Cotton 40% Polyester	TURKEY	5211-49-0020	\$75.50
2831	36161	17.9	54	0		0 42% Cotton 36% Rayon 22%Polyester	CHINA	5211.19.0020	\$62.00
2851	36162	14	57	0		0 90% Polyester 10% Nylon	CHINA	5506.90.0000	\$64.00
2851	36163	18	56	0		0.25 100% Polyester	CHINA	5906-99-2500	\$75.50
2851	36164	22	54	0		0.38 100% Polyester	CHINA	5906-99-2500	\$75.50
2852	36165	16	56	0.25		1.25 100% Polyester	CHINA	5801.36.0010	\$66.00
2852	36166	16	56	1		0.88 100% Polyester	CHINA	5801.36.0010	\$66.00
2852	36167	16	56	0.88		0.88 100% Polyester	CHINA	5801.36.0010	\$66.00
2860	36169	23.8	54	0.13		0.88 42% Cotton 32% Linen 26%Rayon	CHINA	5211.49.0090	\$76.50
2860	36170	18.3	55	0.38		0.63 44% Rayon 33% Polyester 23% Cotton	CHINA	5516.93.0020	\$61.50
2860	36171	19.2	56	1		1 100% Polyester	CHINA	5407-61-9955	\$71.50
2860	36172	13.5	55	0.25		0.25 54% Cotton 46% Polyester	CHINA	5211-49-0020	\$50.50
2860	36173	24.5	56	8.5		0 84% Polyester 16% Rayon	CHINA	5801.36.0020	\$65.50
2873	36174	18.6	57	3		2.88 61% Cotton 39% Polyester	CHINA	5211.41.0020	\$60.50
2860	36175	18.9	54	0		0 100% Polyester	INDIA	5801-36-0010	\$63.00
2860	36178	10	54	0		3.5 51% Polyester 49% Cotton	INDIA	5407-93-2090	\$45.50
2860	36179	16	54	0		0 100% Polyester	INDIA	5801-36-0020	\$58.00
2858	36180	27.2	56	0		7 100% Polyester	CHINA	5801.36.0020	\$53.00
2860	36181	11.4	55	2.75		0 100% Polyester	CHINA	5801.36.0010	\$55.50
2858	36182	14.6	58	1.5		1.13 100% Polyester	MEXICO	5515.12.0090	\$61.00
2858	36183	15.4	55	0		0 50% Polyester 35% Acrylic15% Linen	TURKEY	5515.29.0090	\$70.50
2860	36184	26	54	11.75		6.75 51% Acrylic 49% Polyester	TURKEY	5801-36-0020	\$82.00
2873	36185	12.4	54	0		0 100% Polyester	INDIA	5407-53-2060	\$51.50
2859	36186	21.1	54	0		0 100% Cotton	TURKEY	5209-39-0090	\$56.50
2860	36187	23.8	54	0		0 85% Polyester 15% Rayon	CHINA	5512-19-0090	\$79.00
2860	36188	27.1	61	10.5		7.75 60% Polyester 40% Viscose	CHINA	5515-11-0005	\$64.00
2860	36189	27.1	61	7		7.5 60% Polyester 40% Viscose	CHINA	5515-11-0005	\$64.00
2860	36190	19.4	55	0		0 100% Polyester	CHINA	5407-53-2060	\$64.00
2860	36191	17.4	54	9		7.38 55% Acrylic 45% Polyester	CHINA	5512-99-0005	\$74.00
2891	36192	25.7	55	0		0 100% Polyester	CHINA	5801.36.0020	\$58.50
2860	36193	20.6	54	0		0 100% Polyester	CHINA	5407.53.2060	\$67.50
2858	36194	17.3	54	0.88		0.88 70% Polyester 30% Viscose	CHINA	5407.93.2090	\$63.00
2860	36196	13.7	58	0		1.25 100% Polyester	CHINA	5801.33.0000	\$53.50
2860	36197	28.5	57	0.63		0.5 100% Polyester	CHINA	5407-53-2060	\$70.50
2859	36199	14.3	54	0.5		0.25 100% Polyester	TURKEY	5209.59.0060	\$70.50
2860	36200	13	55	0		0 100% Polyester	CHINA	5906-99-2500	\$44.00
2859	36201	15	55	0		0 85% Polyester 12% Nylon 3% SPANDEX	CHINA	5906-99-2500	\$48.50
2860	36202	18	58	0		0 100% Polyester	CHINA	5906-99-2500	\$46.50
2862	36203	11.4	58	0		0 100% Polyester	CHINA	5407.52.2060	\$41.50
2890	36205	16.7	55	0		0 80% Polyester 20% Linen	CHINA	5903.90.2500	\$45.50
2891	36206	23.1	54	11		14 58% Polyester 38% Rayon 4% Cotton	INDIA	5801.90.2090	\$65.50
2890	36207	23.1	54	11		14 58% Polyester 38% Rayon 4% Cotton	INDIA	5801.90.2090	\$65.50
2923	36208	13.7	54	0		0 75% Polyester 25% Cotton	CHINA	5801.33.0000	\$84.50
2921	36209	4.3	54	9		13.5 57% Polypropylene 43% Polyester	MEXICO	5407.61.9915	\$68.00
2921	36210	4.3	54	27		27 57% Polypropylene 43% Polyester	MEXICO	5407.61.9915	\$68.00
2921	36211	4.3	54	9		9 57% Polypropylene 43% Polyester	MEXICO	5407.61.9915	\$68.00
2921	36212	4.3	54	3.25		3 57% Polypropylene 43% Polyester	MEXICO	5407.61.9915	\$68.00

**Duralee
Retail Price List
(Limited Stock items excluded)**

Prices effective - July 1, 2016

Book	Pattern	Weight	Width	Vertical Repeat	Horizontal Repeat	Content	Origin	Tariff1	Retail
2921	36213	4.3	54	6.75		0 57% Polypropylene 43% Polyester	MEXICO	5407.61.9915	\$68.00
2921	36214	4.3	54	1.63		4.5 57% Polypropylene 43% Polyester	MEXICO	5407.61.9915	\$68.00
2921	36215	4.3	54	27		27 54% Polypropylene 46% Polyester	MEXICO	5407.61.9915	\$68.00
2921	36216	4.3	54	7.25		7 56% Polypropylene 44% Polyester	MEXICO	5407.61.9915	\$68.00
2921	36217	17.9	54	9.75		7 100% Polyester	USA	5407.54.0060	\$73.50
2921	36218	4.3	54	7.75		9.25 57% Polypropylene 43% Polyester	MEXICO	5407.61.9915	\$68.00
2921	36219	4.3	54	22		0 50% Polypropylene 50% Polyester	MEXICO	5407.61.9915	\$58.00
2921	36220	14.7	58	0		0 100% Polyester	USA	5407.69.9060	\$58.50
2923	36221	16	55	0		0 55% Rayon 45% Polyester	CHINA	5801.33.0000	\$100.50
2928	36222	16.6	58	0		0 100% Polyester	CHINA	5309.29.4010	\$59.50
2928	36223	24	56	0		0 100% Polyester	CHINA	5906.99.2500	\$71.50
2955	36224	24	54	13.75		6.75 100% Polyester	CHINA	5801.36.0010	\$62.00
2925	36225	20.8	54	7.25		3.75 100% Polyester	CHINA	5407.69.4060	\$67.50
2926	36226	14.9	55	9		13.75 100% Polyester	TURKEY	5407.73.2060	\$90.50
2928	36227	14.6	56	6.88		7.13 100% Polyester	CHINA	5515.12.0090	\$69.00
2928	36228	13.7	56	7		7 60% Cotton 40% Polyester	CHINA	5211.49.0020	\$63.00
2928	36229	22.5	56	18.75		14.5 47% Cotton 20% Viscose 20% Polyester 13% Linen	CHINA	5211.49.0020	\$82.50
2927	36230	14	56	0		0 90% Polyester 10% Nylon	CHINA	5906.99.2500	\$48.50
2928	36231	12.1	55	0		0 100% Polyester	CHINA	5407.61.9955	\$43.00
2943	36232	25	56	0		0 58% Cotton 30% Viscose 12% Linen	INDIA	5211.49.0020	\$70.50
2943	36233	9.3	56	0.13		0.38 100% Cotton	TURKEY	5209.49.0020	\$80.50
2943	36234	24.5	58	0		0 100% Cotton	CHINA	5209.42.0080	\$45.50
2950	36235	19.6	54	7.25		7.25 100% Polyester	CHINA	5407.69.4060	\$70.50
2952	36236	14.4	54	9.5		10 100% Polyester	CHINA	5407.69.4060	\$50.50
2952	36237	19	54	15.5		14 52% Cotton 48% Polyester	CHINA	5211.49.0020	\$65.50
2951	36238	10	57	0.75		0.75 85% Cotton 15% Polyester	CHINA	5801.36.0000	\$55.50
2952	36239	20.3	55	2.5		2 100% Cotton	CHINA	5209.49.0020	\$72.50
2952	36240	19	54	0		0 100% Polyester	INDIA	5515.19.0005	\$48.50
2952	36241	17.1	56	13		14 39% Cotton 33% Polyester 28% Rayon	CHINA	5212.24.6030	\$60.50
2952	36242	17.4	57	7.5		3.5 52% Cotton 48% Polyester	CHINA	5211.49.0020	\$65.50
2950	36243	17.6	56	17		14 100% Polyester	CHINA	5801.36.0010	\$67.50
2951	36244	18	58	0		0 100% Polyester	CHINA	5906.99.2500	\$48.00
2952	36245	11.5	55	2		1.5 62% Cotton 38% Polyester	TAIWAN	5211.49.0020	\$55.50
2955	36246	16.5	55.5	0		12.75 87% Polyester 13% Viscose	INDIA	5801.36.0020	\$64.50
2955	36247	14.1	55	0		0 100% Polyester	INDIA	5801.36.0020	\$52.00
2955	36248	13.1	54	0		0 100% Polyester	CHINA	5801.36.0020	\$38.00
2955	36249	10.7	55	0		0 64% Cotton 36% Polyester	CHINA	5903.90.2500	\$56.50
2955	36250	20.6	55	0		0 100% Polyester	CHINA	5516.93.0020	\$50.00
2955	36251	23.1	55	0.88		0.75 62% Rayon 38% Polyester	CHINA	5801.36.0020	\$45.50
2955	36252	21.8	58	0		0 70% Polyester 30% Rayon	CHINA	5407.61.9935	\$54.50
2955	36253	23	57	0		0 74% Polyester 26% Rayon	CHINA	5801.36.0010	\$70.50
2955	36254	22.8	54	0.38		0.25 100% Polyester	CHINA	5407.61.9955	\$58.50
2955	36255	14.9	55	0		0 100% Polyester	CHINA	5407.52.2060	\$42.50
2955	36256	17.7	54	0		0 100% Cotton	INDIA	5209.41.6020	\$63.50
2955	36257	18.4	54	1.5		2.75 70% Cotton 30% Polyester	CHINA	5211.49.0020	\$59.00
2955	36258	17	58	0		0 52% Cotton 31% Polyester 17% Rayon	CHINA	5801.36.0010	\$63.00
2955	36259	18.9	54	2.5		3.5 64% Rayon 36% Polyester	CHINA	5801.36.0010	\$73.00
2955	36260	16	57	0		0 100% Polyester	CHINA	5906.99.2500	\$54.50
2955	36261	15	59	0		0 100% Polyester	CHINA	5906.99.2500	\$43.00
2955	36262	17.4	54	0		0 100% Cotton	INDIA	5209.39.0080	\$55.50
2955	36263	20	54	0		0 59% Polyester 31% Cotton 10% Acrylic	USA	5514.30.3200	\$60.00
2967	36264	21.9	58	7.5		5.38 46% Viscose 40% Cotton 14% Polyester	INDIA	5801370000	\$140.50
2967	36265	25.6	60	3.88		4.75 49% Viscose 31% Cotton 20% Polyester	INDIA	5801330000	\$140.50
2967	36266	31.4	55	11.13		13.63 54% Viscose 30% Polyester 16% Cotton	INDIA	5801370000	\$140.50
2967	36267	23.4	55	3.88		2.75 51% Viscose 32% Polyester 17% Cotton	INDIA	5801330000	\$140.50
2967	36268	10.5	60	5.63		10.75 52% Viscose 48% Polyester	INDIA	5801330000	\$140.50
2967	36269	31.4	55	13.38		6.88 54% Viscose 30% Polyester 16% Cotton	INDIA	5801370000	\$140.50
2967	36270	29.8	55	27.25		27.25 54% Viscose 30% Polyester 16% Cotton	INDIA	5801370000	\$140.50

**Duralee
Retail Price List
(Limited Stock items excluded)**

Prices effective - July 1, 2016

Book	Pattern	Weight	Width	Vertical Repeat	Horizontal Repeat	Content	Origin	Tariff1	Retail
2967	36271	22.6	54	5.25	6.75	40% Viscose 39% Polyester21% Cotton	INDIA	5801370000	\$140.50
2971	36273	13.1	55	0	0	100% Polyester	INDIA	5801360000	\$48.50
2972	36274	20.9	54	0	0	75% Linen 25% Rayon	CHINA	5309290000	\$82.50
2972	36275	14.1	54	0	0	55% Linen 45% Cotton	CHINA	5309290000	\$72.50
2977	36281	18.4	54	0.5	0.75	100% Polyester	INDIA	5512199990	\$62.50
2977	36282	18.4	54	0	0	100% Polyester	INDIA	5512199990	\$62.50
2991	36283	9.3	54	0	9	100% Cotton	INDIA	5209.49.0040	\$65.00
2991	36284	13.7	54	0	8	100% Cotton	INDIA	5209.12.0020	\$50.00
2991	36285	16.8	54	0	3.75	100% Cotton	TAIWAN	5209.49.0090	\$55.00
2991	36286	16.6	54	0.38	9	70% Cotton 30% Jute	INDIA	5212.24.6090	\$83.00
2991	36287	18.8	54	0	13.75	100% Polyester	INDIA	5515.12.0090	\$73.50
2991	36288	25.7	54	0	0	84% Polyester 16% Viscose	INDIA	5407.93.2090	\$78.50
2991	36289	22.1	54	0	0	57% Polyester 32% Cotton11% Linen	CHINA	5407.83.0090	\$73.50
2991	36290	22	56	0	7	100% Polyester	CHINA	5407.93.2090	\$53.00
2991	36291	19.7	54	0	0	100% Polyester	INDIA	5407.93.2090	\$73.50
2992	36292	18.1	54	1.38	1.75	100% Polyester	CHINA	5903.10.3000	\$100.00
2992	36293	13.5	54	0	0	100% Polyester	CHINA	5903.90.1500	\$68.50
2992	36294	18.1	54	1.38	1.75	100% Polyester	CHINA	5903.10.3000	\$100.00
2991	36295	25.2	54	0	0	77% Polyester 23% Viscose	INDIA	5801.36.0020	\$85.00
2997	36296	18.5	55	3	2.75	58% Cotton 42% Polyester	TURKEY	5211.49.0020	\$70.00
2995	36297	20.1	54	3	3.75	51% Polyester 49% Rayon	CHINA	5407.73.2060	\$60.00
2997	36298	17.3	54	5	1	64% Polyester 36% Rayon	CHINA	5407.73.2060	\$50.00
2996	36299	14	55	0	0	73% Polyester 27% Viscose	INDIA	5515.12.0090	\$80.00
2997	36300	24.1	56	6.5	3.5	52% Rayon 26% Polyester 22% Cotton	CHINA	5801.36.0020	\$60.00
2997	36301	12	55	4.75	7.25	100% Polyester	CHINA	5516.23.0090	\$55.00
2997	36302	17.6	58	4	0	58% Acrylic 42% Polyester	CHINA	5801.36.0010	\$50.00
2997	36303	21	54	1.88	2.25	57% Cotton 43% Polyester	CHINA	5211.49.0020	\$68.50
2997	36304	14.2	54	1.63	1.5	61% Rayon 39% Polyester	CHINA	5516.23.0090	\$62.50
2997	36305	16.9	55	1	1	75% Polyester 25% Cotton	CHINA	5514.30.3310	\$63.50
2997	36306	22.5	56	7.25	9.25	100% Polyester	CHINA	5801.36.0010	\$70.00
2997	36307	16.2	54	0	0	71% Polyester 29% Rayon	INDIA	5407.93.2090	\$75.00
2726	42055	12.8	54	18	6.75	100% Cotton	USA	5209-51-6090	\$47.00
2726	42058	11	54	25.25	13.5	100% Cotton	USA	5209-51-6090	\$42.00
2726	42060	14.6	54	27	27	55% Linen 45% Rayon	USA	5309-21-3090	\$60.00
2762	42105	10.8	54	25.5	27	100% Cotton	PERU	5208-59-1000	\$54.00
2762	42106	7.7	54	27	27	100% Cotton	PERU	5208-59-1000	\$54.00
2969	42108	7.7	54	27	27	100% Cotton	PERU	5208-59-1000	\$54.00
2762	42109	14.6	54	27	27	55% Linen 45% Rayon	USA	5309-21-3090	\$60.00
2779	42113	17.7	54	27	27	100% Cotton	USA	5209-59-0090	\$79.00
2779	42114	17.7	54	25.25	27	100% Cotton	CHINA	5209-59-0090	\$64.00
2779	42121	10.4	54	9	9	100% Cotton	USA	5209-51-6090	\$37.50
2780	42124	17.7	54	25.25	27	100% Cotton	CHINA	5209-59-0090	\$64.00
2787	42126	11.6	54	0	1.63	100% Cotton	TURKMENISTAN	5209.51.6025	\$37.50
2788	42131	17.7	54	9	6.88	100% Cotton	CHINA	5209-59-0090	\$64.00
2788	42135	16.2	54	18	18	55% Linen 45% Rayon	CHINA	5309.29.4010	\$59.00
2788	42140	15.8	54	18	27	55% Linen 45% Rayon	CHINA	5309.29.4010	\$59.00
2785	42141	9.9	54	1	1.5	100% Cotton	SOUTH KOREA	5209.59.0090	\$43.50
2788	42142	13.3	54	6.75	6.75	100% Cotton	PAKISTAN	5209.59.0090	\$59.00
2788	42143	9.5	54	13.5	13.5	100% Cotton	PERU	5208.59.6090	\$59.00
2787	42145	9.9	54	0	3.38	100% Cotton	SOUTH KOREA	5209.59.0090	\$43.50
2782	42146	12.1	54	0	3	100% Cotton	PAKISTAN	5209.59.0090	\$46.50
2804	42148	8.8	54	13.5	13.5	100% Cotton	USA	5208-53-3045	\$47.00
2804	42149	8.8	54	3.88	13.5	100% Cotton	USA	5208-53-3045	\$43.50
2805	42150	14.6	54	36	27	55% Linen 45% Rayon	USA	5309-21-3090	\$65.00
2805	42151	8.8	54	27	27	100% Cotton	USA	5208-53-3045	\$49.00
2805	42154	17.7	54	25.25	27	100% Cotton	CHINA	5209-59-0090	\$68.50
2805	42156	17.7	54	25.25	27	100% Cotton	CHINA	5209-59-0090	\$68.50
2812	42159	21.1	54	13.5	13.5	100% Cotton	PAKISTAN	5209.59.0090	\$43.50

**Duralee
Retail Price List
(Limited Stock items excluded)**

Prices effective - July 1, 2016

Book	Pattern	Weight	Width	Vertical	Horizontal	Content	Origin	Tariff1	Retail
				Repeat	Repeat				
2812	42160	1.6	54	9	9	100% Cotton	SOUTH KOREA	5209.59.0090	\$43.50
2812	42161	1	54	9	13.5	55% Linen 45% Rayon	CHINA	5309.29.4010	\$62.50
2812	42162	10	54	1.5	2.75	100% Cotton	USA	5209.59.0025	\$44.50
2818	42170	11.3	54	9	9	100% Cotton	USA	5209.59.0025	\$38.50
2818	42172	11.3	54	6	5.38	100% Cotton	USA	5209.59.0025	\$45.50
2818	42173	10.4	54	13.5	9	100% Cotton	USA	5209.51.6090	\$37.00
2818	42175	10.4	54	18	9	100% Cotton	USA	5209.51.6090	\$37.00
2818	42176	10.4	54	12.63	9	100% Cotton	USA	5209.51.6090	\$37.00
2818	42177	11.3	54	13.5	13.5	100% Cotton	USA	5209.59.0025	\$45.50
2819	42178	11.7	54	27	13.5	100% Cotton	PERU	5209.59.0090	\$55.50
2819	42179	11.7	54	13.5	13.5	100% Cotton	PERU	5209.59.0090	\$55.50
2819	42182	11.7	54	12.25	13.5	100% Cotton	PERU	5209.59.0090	\$55.50
2819	42183	14.6	54	25.25	27	55% Linen 45% Rayon	USA	5309.21.3090	\$55.50
2823	42184	13.8	54	25.25	13.5	100% Cotton	PERU	5801.36.0020	\$55.50
2824	42188	13.3	54	0	27	100% Linen	CHINA	5309.29.4090	\$72.50
2824	42189	13.3	54	25.25	13.5	100% Linen	CHINA	5309.29.4090	\$72.50
2824	42190	13.3	54	25.25	13.5	100% Linen	CHINA	5309.29.4090	\$72.50
2824	42191	13.3	54	12.63	9	100% Linen	CHINA	5309.29.4090	\$72.50
2824	42192	14.6	54	12.63	6.75	55% Linen 45% Rayon	USA	5309.21.3090	\$58.50
2825	42194	14.6	54	32	27	55% Linen 45% Rayon	USA	5309.21.3090	\$58.50
2825	42196	13.3	54	25.25	27	100% Linen	CHINA	5309.29.4090	\$72.50
2825	42197	10.5	54.5	26.75	27	100% Cotton	UAE	5209.51.6025	\$52.50
2825	42198	14.4	54	36	27	55% Linen 45% Rayon	USA	5309.21.4090	\$65.00
2825	42199	15.2	54	25.25	13.5	100% Cotton	USA	5209.59.0090	\$44.50
2825	42200	14.6	54	27	27	55% Linen 45% Rayon	USA	5309.21.3090	\$65.00
2825	42201	14.6	54	32	27	55% Linen 45% Rayon	USA	5309.21.3090	\$59.50
2825	42203	1	54	25.25	27	55% Linen 45% Rayon	CHINA	5309.29.4010	\$62.50
2825	42204	17.7	54	32	27	100% Cotton	USA	5209.59.0090	\$80.50
2825	42205	16.2	54	27	27	55% Linen 45% Rayon	CHINA	5309.29.4010	\$59.00
2825	42206	16.2	54	25.25	27	55% Linen 45% Rayon	CHINA	5309.29.4010	\$62.50
2825	42207	15.2	54	27	27	100% Cotton	SOUTH KOREA	5209.59.0090	\$67.50
1000	42208	14.6	54	25.25	27	55% Linen 45% Rayon	USA	5309.21.3090	\$58.50
1000	42210	12.4	55	13.5	18	84% Polyester 16% Cotton	INDIA	5407.84.0090	\$76.50
2834	42211	14.7	54.5	13.5	13.5	100% Cotton	TURKMENISTAN	5209.39.0060	\$42.00
2832	42213	19.2	54	2.88	3	100% Cotton	PAKISTAN	5209.59.0090	\$57.00
2827	42214	16.2	54	12.75	13.5	55% Linen 45% Rayon	CHINA	5309.29.4010	\$59.50
2834	42216	19.2	54	6	6	100% Cotton	PAKISTAN	5209.59.0090	\$60.00
2834	42217	16.2	54	12.75	13.5	55% Linen 45% Rayon	CHINA	5209.29.4010	\$62.50
2834	42218	21.1	54	13.25	27	100% Cotton	PAKISTAN	5209.59.0090	\$50.00
2834	42219	22.1	55	25.25	27	100% Cotton	PERU	5208.59.6090	\$67.50
2833	42222	19.2	54	23.5	27.38	100% Cotton	PAKISTAN	5209.59.0090	\$57.00
2834	42223	26.9	54	11.63	8.75	100% Cotton	PERU	5208.59.6090	\$59.50
2829	42224	21.1	54	1.5	1	100% Cotton	PAKISTAN	5209.59.0090	\$48.50
2834	42225	14.6	54	0	4.38	55% Linen 45% Rayon	USA	5309.21.3090	\$64.00
2833	42227	10.3	54	1.38	1.38	100% Cotton	USA	5209.51.6090	\$40.50
2834	42230	14.6	54	13.25	13.75	55% Linen 45% Rayon	USA	5309.21.3090	\$64.00
2831	42234	8.7	54	3	3	100% Cotton	PERU	5208.59.1000	\$60.50
2855	42235	14.8	54	0	0	55% Linen 45% Rayon	USA	5309.21.3090	\$65.50
2855	42236	8.7	54	27	27	100% Cotton	PERU	5208.59.1000	\$55.50
2855	42237	8.7	54	13.5	13.5	100% Cotton	PERU	5208.59.1000	\$55.50
2855	42238	11.3	54	3.38	9	100% Cotton	USA	5209.59.0025	\$45.50
2855	42239	14.6	54	25.25	27	55% Linen 45% Rayon	USA	5309.21.3090	\$58.50
2855	42240	14.6	54	27	27	55% Linen 45% Rayon	USA	5309.21.3090	\$58.50
2855	42241	10.4	54	0	13.5	100% Cotton	USA	5209.51.6090	\$43.50
2855	42242	15.2	54	25.25	27	100% Cotton	USA	5209.59.0090	\$48.50
2855	42243	7.3	54	18	6.75	100% Cotton	CHINA	5209.59.0090	\$47.50
2856	42244	14.6	54	25.25	13.5	55% Linen 45% Rayon	USA	5309.21.3090	\$65.00
2889	42245	10.4	54	13.5	9	100% Cotton	USA	5209.51.6090	\$43.50

**Duralee
Retail Price List
(Limited Stock items excluded)**

Prices effective - July 1, 2016

Book	Pattern	Weight	Width	Vertical		Content	Origin	Tariff1	Retail
				Repeat	Horizontal Repeat				
2856	42246	15.2	54		3	3 100% Cotton	USA	5209-59-0090	\$43.50
2856	42247	14.4	54	25.25		27 55% Linen 45% Rayon	USA	5309-21-4090	\$58.50
2856	42248	10.4	54		0	27 100% Cotton	USA	5209-51-6090	\$43.50
2856	42249	10.4	54		4.5	3 100% Cotton	USA	5209-51-6090	\$43.50
2856	42250	12.4	54	25.25		27 89% Cotton 11% Rayon	USA	5209-11-0090	\$48.50
2856	42252	14	54		18	13.5 100% Cotton	CHINA	5209.59.0060	\$55.50
2856	42253	14	54		9	9 100% Cotton	CHINA	5209.59.0060	\$55.50
2856	42254	14	54		9	13.5 100% Cotton	CHINA	5209.59.0060	\$55.50
2856	42255	8.7	54	25.25		18 100% Cotton	PERU	5208.59.1000	\$60.50
2856	42256	17.2	54		27	13.5 70% Cotton 30% Linen	USA	5212-23-6090	\$70.50
2857	42258	14.6	54		27	27 55% Cotton 45% Rayon	USA	5309-21-3090	\$58.50
2857	42261	17.7	54	25.25		27 100% Cotton	CHINA	5209-39-0090	\$67.50
2857	42262	15.2	54		24	27 100% Cotton	PAKISTAN	5209.59.0090	\$67.50
2857	42263	15.2	54		27	27 100% Cotton	PAKISTAN	5209.59.0090	\$67.50
2857	42264	16.8	54		18	27 100% Cotton	SOUTH KOREA	5209.59.0090	\$67.50
2872	42265	8.8	54		13.5	27 100% Cotton	CHINA	5208.52.3045	\$43.50
2871	42266	14	54		2	2.5 100% Cotton	CHINA	5209.51.6090	\$53.50
2871	42267	10.2	54.5		13.5	13.5 100% Cotton	TURKMENISTAN	5209.51.6090	\$38.00
2873	42268	7.3	55		6.25	3.5 100% Cotton	PAKISTAN	5209.59.0090	\$52.50
2872	42269	12.1	54		9	9 100% Cotton	USA	5209.51.6090	\$50.50
2867	42270	14.1	54	14.75		10 100% Linen	USA	5309.19.0010	\$71.50
2871	42271	14.1	54		8	5.63 100% Linen	USA	5309.19.0010	\$71.50
2872	42272	14.1	54		11.5	9.5 100% Linen	USA	5309.19.0010	\$71.50
2867	42273	14.1	54	16.75		8 100% Linen	USA	5309.19.0010	\$71.50
2869	42274	19.2	54		3	3 100% Cotton	PAKISTAN	5209.59.0090	\$62.50
2873	42275	19.2	54		5	3 100% Cotton	PAKISTAN	5209.59.0090	\$60.00
2888	42276	21.1	54		6.75	13.5 100% Cotton	PAKISTAN	5209.59.0090	\$50.00
2872	42277	16.2	54		3	3 55% Linen 45% Rayon	CHINA	5309.29.4010	\$60.50
2871	42278	19.2	54		4.5	4.5 100% Cotton	PAKISTAN	5209.59.0090	\$60.00
2870	42279	19.2	54		27	13.5 100% Cotton	PAKISTAN	5209.59.0090	\$60.00
2871	42280	16.2	54		13.5	6.75 55% Linen 45% Rayon	CHINA	5309.29.4010	\$62.50
2869	42281	16.2	54		9	13.5 55% Linen 45% Rayon	CHINA	5309.29.4010	\$62.50
2887	42282	16.2	54		13.5	13.5 55% Linen 45% Rayon	CHINA	5309.29.4010	\$62.50
2888	42283	19.2	54		12	6.75 100% Cotton	PAKISTAN	5209.59.0090	\$60.00
2891	42284	22.1	54		6.75	6.75 100% Cotton	PERU	5208.59.6090	\$67.50
2871	42285	13	54		5.25	3.38 100% Cotton	USA	5209.59.0025	\$45.50
2872	42286	15.5	54		2.75	3.88 100% Cotton	USA	5209.59.0090	\$45.50
2872	42287	13	54		4.5	4.5 100% Cotton	USA	5209.59.0025	\$45.50
2871	42288	13	54		9	6.75 100% Cotton	USA	5209.59.0025	\$45.50
2872	42290	15.5	54		6.75	6.75 100% Cotton	USA	5209.59.0090	\$45.50
2871	42291	13.9	54		13.5	13.5 100% Cotton	USA	5209.59.0090	\$45.50
2871	42293	8.8	54		6.38	6.75 100% Cotton	CHINA	5209.52.0040	\$43.50
2891	42295	16	54		6.38	6.75 100% Cotton	CHINA	5209.59.0090	\$53.50
2883	42296	14	54		19.5	14.5 55% Linen 45% Rayon	CHINA	5309.29.4010	\$64.00
2883	42297	10.4	54		27	27 100% Cotton	USA	5209.51.6090	\$44.50
2883	42298	10.4	54		0	27 100% Cotton	USA	5209.51.6090	\$44.50
2883	42299	8.8	54	25.25		27 100% Cotton	USA	5208.53.3045	\$44.50
2883	42300	11	54	25.25		13.5 100% Cotton	USA	5209.51.6090	\$49.50
2883	42301	14.6	54		32	27 55% Linen 45% Rayon	USA	5309.21.3090	\$64.00
2883	42302	12.4	54		32	27 89% Cotton 11% Rayon	USA	5209.59.0040	\$60.50
2883	42303	8.8	54	25.25		13.5 100% Cotton	USA	5208.53.3045	\$44.50
2883	42304	8.8	54		0	13.5 100% Cotton	USA	5208.53.3045	\$44.50
2883	42305	0	54		27	27 100% Cotton	PAKISTAN	5209.59.0090	\$67.50
2883	42306	15.2	54		27	13.5 100% Cotton	PAKISTAN	5209.59.0090	\$67.50
2889	42309	15.2	54		3.63	5.38 100% Cotton	CHINA	5209.59.0090	\$44.50
2888	42310	12.1	54		6.38	6.75 100% Cotton	USA	5209.51.6090	\$44.00
2885	42311	14	54		4	4.25 55% Linen 45% Rayon	CHINA	5309.29.4010	\$64.00
2889	42312	14	54		9.38	9 55% Linen 45% Rayon	CHINA	5309.29.4010	\$64.00

**Duralee
Retail Price List
(Limited Stock items excluded)**

Prices effective - July 1, 2016

Book	Pattern	Weight	Width	Vertical Repeat	Horizontal Repeat	Content	Origin	Tariff1	Retail
2890	42314	8.5	54	25.25	25.25	100% Polyester	USA	5407.61.9935	\$45.50
2886	42315	8.5	54	0.25	3.5	100% Polyester	USA	5407.61.9935	\$45.50
2891	42316	14.1	54	12.5	12	100% Linen	USA	5309.19.0010	\$71.50
2887	42317	14.1	54	12.5	13.5	100% Linen	USA	5309.19.0010	\$71.50
2889	42318	14.1	54	12.5	10.75	100% Linen	USA	5309.19.0010	\$71.50
2888	42319	14.1	54	8	6.75	100% Linen	USA	5309.19.0010	\$71.50
2891	42320	14.1	54	24	26	100% Linen	USA	5309.19.0010	\$71.50
2891	42321	14.1	54	7.5	13.5	100% Linen	USA	5309.19.0010	\$71.50
2887	42322	12	54	25.25	13.5	100% Cotton	USA	5209.51.6090	\$44.50
2891	42323	14.7	54	9	9	100% Linen	CHINA	5309.19.0010	\$83.50
2891	42324	17.7	54	12.63	6.75	100% Cotton	USA	5209.59.0090	\$79.00
2887	42325	10.4	54	0	5.38	100% Cotton	USA	5209.51.6090	\$44.50
2889	42326	19	54	12.63	6.75	55% Linen 45% Rayon	USA	5309.21.3090	\$64.00
2891	42327	19	54	13.5	13.5	55% Linen 45% Rayon	USA	5309.21.3090	\$64.00
2887	42329	15.7	54	5	5.38	100% Cotton	USA	5209.51.6090	\$50.50
2888	42331	16.2	54	6.75	6.75	55% Linen 45% Rayon	CHINA	5309.29.4010	\$67.50
2889	42332	19.2	54	4.5	6.75	100% Cotton	PAKISTAN	5209.59.0090	\$62.50
2890	42333	22.1	54	9	9	100% Cotton	PERU	5208.59.6090	\$67.50
2888	42334	22.8	54	6.75	6.75	100% Cotton	TURKMENISTAN	5209.51.6090	\$37.50
2891	42335	15.2	54	9	9	100% Cotton	PAKISTAN	5209.59.0090	\$70.50
2898	42336	14.6	54	27	27	55% Linen 45% Rayon	USA	5309.21.3090	\$64.00
2898	42337	13.3	54	25.25	27	100% Linen	CHINA	5309.29.4090	\$74.00
2898	42338	13.3	54	25.25	27	100% Linen	CHINA	5309.29.4090	\$74.00
2898	42340	8.8	54	12.63	27	100% Cotton	USA	5208.53.3045	\$44.50
2898	42341	8.8	54	25.25	13.5	100% Cotton	USA	5208.53.3045	\$44.50
2898	42342	14.6	54	36	27	55% Linen 45% Rayon	USA	5516.92.0090	\$64.00
2898	42343	12.1	54	27	27	100% Cotton	USA	5209.51.6090	\$49.50
2898	42344	19.3	54	27	25.25	100% Cotton	PAKISTAN	5209.19.0090	\$72.00
2898	42345	15.9	54	27	27	55% Linen 45% Rayon	CHINA	5309.29.4010	\$64.00
2898	42346	15.9	54	27	25.25	55% Flax 45% Rayon	CHINA	5309.29.4010	\$64.00
2913	42347	13.8	54	23.5	27	100% Cotton	CHINA	5209.39.0090	\$53.50
2913	42348	13.8	54	24	27	100% Cotton	CHINA	5209.39.0090	\$53.50
2913	42349	13.8	54	13.5	13.5	100% Cotton	CHINA	5209.39.0090	\$53.50
2913	42350	13.8	54	10	6.75	100% Cotton	CHINA	5209.39.0090	\$53.50
2914	42351	11.3	54	27	24.75	100% Cotton	PERU	5208.59.1000	\$60.50
2914	42352	11.3	54	0	27	100% Cotton	PERU	5208.59.1000	\$60.50
2914	42353	13.3	54	25.25	27	100% Linen	CHINA	5309.29.4090	\$85.00
2914	42354	8.9	54	25.25	13.5	100% Cotton	CHINA	5209.52.0040	\$44.50
2914	42355	13.3	54	25.25	27	100% Linen	CHINA	5309.29.4090	\$85.00
2914	42356	14.6	54	36	27	55% Linen 45% Rayon	USA	5309.21.3090	\$64.00
2914	42357	12.1	54	27	27	100% Cotton	USA	5209.51.6090	\$53.50
2914	42358	13.3	54	25.25	13.5	100% Linen	CHINA	5309.29.4090	\$74.00
2914	42359	12.1	54	25.25	27	100% Cotton	USA	5209.51.6090	\$53.50
2914	42360	13.3	54	24.5	6.75	100% Linen	CHINA	5309.29.4090	\$85.00
2914	42361	8.8	54	13.5	13.5	100% Cotton	USA	5208.53.3045	\$43.50
2914	42362	15	54	27	27	100% Cotton	SOUTH KOREA	5209.59.0090	\$75.50
2908	42363	12.1	54	27	27	100% Cotton	USA	5209.51.6090	\$53.50
2908	42364	12.1	54	13.5	13.5	100% Cotton	USA	5209.51.6090	\$53.50
1000	42365	10.4	50	27	27	100% Cotton	USA	5209.51.6090	\$43.50
1000	42366	10.4	54	27	13.5	100% Cotton	USA	5209.51.6090	\$43.50
2917	42367	7	54	25	5.5	87% Cotton 13% Rayon	USA	5209.59.0090	\$49.50
2917	42368	7	54	8.13	54	100% Cotton Duck	USA	5209.51.6090	\$40.50
2917	42369	7	54	7.75	4.75	100% Cotton Duck	USA	5209.51.6090	\$46.00
2917	42370	7	54	3.5	9	100% Cotton Slub Duck	USA	5208.51.6090	\$46.00
2917	42371	7	54	3.5	2.5	100% Cotton Duck	USA	5209.51.6090	\$40.50
2917	42372	7	54	3.5	2.5	100% Cotton Slub Duck	USA	5209.51.6090	\$46.00
2917	42373	7	54	4.13	9	100% Cotton Duck	USA	5209.51.6090	\$36.50
2917	42374	7	54	4.13	9	100% Cotton Duck	USA	5209.51.6090	\$36.50

**Duralee
Retail Price List
(Limited Stock items excluded)**

Prices effective - July 1, 2016

Book	Pattern	Weight	Width	Vertical	Horizontal	Content	Origin	Tariff1	Retail
				Repeat	Repeat				
2917	42375	6.5	54	4.13	9	100% Cotton	USA	5208.59.2095	\$36.50
2917	42376	7	54	12.5	36	100% Cotton Duck	USA	5209.51.6090	\$36.50
2917	42377	6.5	54	12.5	36	100% Cotton	USA	5208.59.2095	\$36.50
2917	42378	6.5	54	12.5	5	100% Cotton	USA	5208.59.2095	\$40.50
2917	42379	7	54	12.5	5	100% Cotton Slub Duck	USA	5209.51.6090	\$46.00
2917	42380	7	54	25	13.38	100% Cotton Duck	USA	5209.51.6090	\$36.50
2917	42381	7	54	2.5	2.5	100% Cotton Duck	USA	5209.51.6090	\$40.50
2917	42382	7	54	2.5	2.5	100% Cotton Slub Duck	USA	5209.51.6090	\$38.50
2917	42383	7	54	12.5	54	100% Cotton Slub Duck	USA	5209.51.6090	\$46.00
2917	42384	9.8	54	10	7	100% Cotton	USA	5209.51.6090	\$46.00
2917	42385	7	54	10	5.25	100% Cotton Slub Duck	USA	5209.51.60900	\$46.00
2917	42386	7	54	0.5	4.13	100% Cotton Duck	USA	5209.51.6090	\$36.50
2917	42387	6.5	54	0.5	4.13	100% Cotton	USA	5208.59.2095	\$36.50
2917	42388	7	54	12.25	13.5	100% Cotton Duck	USA	5209.51.6090	\$40.50
2917	42389	6.5	54	12.25	13.5	100% Cotton	USA	5209.51.6090	\$40.50
2917	42390	7	54	6	4.25	87% Cotton 13% Rayon	USA	5209.59.0090	\$49.50
2917	42391	7	54	2.5	2.5	100% Cotton Duck	USA	5209.51.6090	\$36.50
2917	42392	6.5	54	2.5	2.5	100% Cotton	USA	5208.59.2095	\$36.50
2917	42394	7	54	24.5	7.75	100% Cotton Duck	USA	5209.51.6090	\$40.50
2917	42395	7	54	24.5	7.75	87% Cotton 13% Rayon	USA	5209.59.0090	\$49.50
2917	42396	7	54	24.5	7.75	100% Cotton Slub Duck	USA	5209.51.6090	\$46.00
2917	42397	7	54	5	9	100% Cotton Duck	USA	5209.51.6090	\$40.50
2917	42398	6.5	54	5	9	100% Cotton	USA	5208.59.2095	\$40.50
2917	42399	7	54	5	9	100% Cotton Slub Duck	USA	5209.51.6090	\$46.00
2917	42400	7	54	5	5.25	100% Cotton Slub Duck	USA	5209.51.6090	\$40.50
2917	42401	7	54	5	13.38	100% Cotton Duck	USA	5209.51.6090	\$36.50
2917	42402	7	54	5	13	100% Cotton Slub Duck	USA	5209.51.6090	\$42.50
2917	42403	7	54	12.5	13.5	100% Cotton Duck	USA	5209.51.6090	\$36.50
2917	42404	7	54	3	4.5	100% Cotton Duck	USA	5209.51.6090	\$40.50
2917	42405	7	54	12.25	3.5	100% Cotton Duck	USA	5209.51.6090	\$40.50
2917	42406	7	54	12.25	3.5	100% Cotton Slub Duck	USA	5209.51.6090	\$46.00
2917	42407	7	54	2	3.75	100% Cotton Duck	USA	5209.51.6090	\$36.50
2917	42408	6.5	54	2	3.75	100% Cotton	USA	5208.59.2095	\$36.50
2917	42409	7	54	4	2.5	100% Cotton Duck	USA	5209.51.6090	\$36.50
2917	42410	6.5	54	4	2.5	100% Cotton	USA	5208.59.2095	\$36.50
2925	42411	17.3	54	9	9	100% Polyester	CHINA	5407.69.9060	\$52.00
2925	42412	15.7	54	2.25	4	100% Cotton	USA	5209.51.6090	\$50.50
2928	42413	19	54	9	9	55% Linen 45% Rayon	USA	5309.21.3090	\$65.50
2927	42414	13	58	4.75	2.63	100% Cotton	INDIA	5209.59.0090	\$85.50
2927	42415	15.2	54	25	13.5	100% Cotton	INDONESIA	5209.59.0090	\$67.50
2926	42416	0	54	0	5	100% Cotton	PAKISTAN	5209.59.0090	\$62.50
2927	42417	19.2	54	6.25	6	100% Cotton	PAKISTAN	5209.59.0090	\$62.50
2927	42418	19.2	54	3	3	100% Cotton	PAKISTAN	5209.59.0090	\$62.50
2926	42419	19.2	54	13.5	6.75	100% Cotton	PAKISTAN	5209.59.0090	\$62.50
2927	42420	19.2	54	9	6.88	100% Cotton	PAKISTAN	5209.59.0090	\$62.50
2925	42421	9.9	54	9	9	100% Cotton	USA	5209.31.6020	\$50.50
2926	42422	25.9	54	25.25	13.5	100% Polyester	CHINA	5801.36.0010	\$85.50
2939	42423	7.4	54	25.5	26.5	100% Cotton	UAE	5209.51.6090	\$53.00
2939	42424	12.1	54	27	27	100% Cotton	USA	5209.51.6090	\$53.50
2939	42425	14.6	54	27	27	55% Linen 45% Rayon	USA	5309.21.3090	\$64.00
2939	42426	9.1	54	27	13.5	100% Cotton	PERU	5209.59.0090	\$65.50
2939	42427	13.1	54	25.25	27	55% Linen 45% Rayon	CHINA	5309.29.4010	\$71.00
2939	42428	13.1	54	25.25	13.5	55% Linen 45% Rayon	CHINA	5309.29.4010	\$71.00
2939	42429	13.1	54	18	13.5	55% Linen 45% Rayon	CHINA	5309.29.4010	\$71.00
2939	42430	20.2	54	27	27	89% Cotton 11% Rayon	TURKEY	5209.59.0090	\$52.00
2939	42431	0	54	13.5	27	100% Cotton	TURKMENISTAN	5209.51.6090	\$40.00
2947	42432	9.8	54	6.38	9	100% Cotton	TURKMENISTAN	5209.51.6025	\$41.00
2947	42435	10.3	54	18	9	100% Cotton	USA	5209.51.6090	\$39.50

**Duralee
Retail Price List
(Limited Stock items excluded)**

Prices effective - July 1, 2016

Book	Pattern	Weight	Width	Vertical Repeat	Horizontal Repeat	Content	Origin	Tariff1	Retail
2947	42436	12	54	31	27.25	100% Polyester	INDIA	5407.61.9955	\$97.50
2947	42437	10.3	54	9	8.38	100% Cotton	USA	5209.51.6090	\$35.50
2947	42438	19.2	54	9	9	100% Cotton	PAKISTAN	5209.59.0090	\$62.00
2947	42439	16.2	54	18	18	55% Linen 45% Rayon	CHINA	5309.29.4010	\$62.50
2951	42441	9.1	54	12.63	9	100% Cotton	PERU	5209.59.0090	\$65.50
2951	42442	14	54	6.75	6.75	100% Cotton	CHINA	5209.59.0060	\$60.50
2952	42443	12.1	54	6.75	6.75	100% Cotton	USA	5209.51.6090	\$50.50
2951	42444	14	54	13.5	6.75	100% Cotton	CHINA	5209.59.0060	\$60.50
2952	42445	14	54	27	27	100% Cotton	CHINA	5209.59.0060	\$60.50
2952	42446	8.7	54	1.25	2.25	100% Cotton	USA	5208.51.4020	\$50.50
2952	42447	10.4	54	9	6.75	100% Cotton	USA	5209.51.6090	\$35.50
2952	42448	12	54	13.5	11	100% Cotton	SOUTH KOREA	5209.52.0020	\$59.50
2948	42449	11.3	54	13.5	9	100% Cotton	TURKMENISTAN	5209.51.6090	\$36.50
2951	42450	10.8	54	18	6.75	100% Cotton	USA	5209.59.0060	\$45.50
2952	42451	13.3	54	4.5	9	100% Cotton	PAKISTAN	5209.59.0090	\$60.00
2968	42452	12.4	54	25.25	9	89% Cotton 11% Rayon	USA	5209110000	\$53.50
2968	42453	10.3	54	13.5	13.5	100% Cotton	USA	5209590000	\$39.50
2968	42454	7	54	25	26.5	100% Cotton Slub Duck	USA	5209410000	\$40.00
2968	42455	7	54	24.5	9	100% Cotton	USA	5209410000	\$44.50
2968	42456	17.6	54	13.5	13.5	100% Cotton	SOUTH KOREA	5309290000	\$70.50
2968	42457	11	54	27	27	100% Cotton Duck	TURKMENISTAN	5209510000	\$38.50
2968	42458	15.8	54	18	9	55% Linen 45% Rayon	CHINA	5309290000	\$62.50
2968	42459	11	54	13.5	13.5	100% Cotton Duck	TURKMENISTAN	5209510000	\$38.50
2968	42460	11.6	54	11.5	13.5	100% Cotton	PERU	5208590000	\$67.50
2969	42461	8.7	54	25.25	27	55% Linen 45% Viscose	KOREA	5309290000	\$69.00
2969	42462	10.4	54	27	27	100% Cotton	USA	5209510000	\$53.50
2969	42463	14.6	55	36	55	55% Linen 45% Rayon	USA	5309210000	\$64.00
2969	42464	13.3	54	12.63	13.5	100% Linen	CHINA	5309290000	\$77.50
2969	42465	13.3	54	25.25	27	100% Linen	CHINA	5309290000	\$77.50
2969	42466	12.5	54	18	13.5	89% Cotton 11% Rayon	USA	5209590000	\$53.50
2969	42467	15.8	54	25.5	27.5	55% Linen 45% Rayon	CHINA	5309290000	\$62.50
2969	42468	15.8	54	25.75	27.5	55% Linen 45% Rayon	CHINA	5309290000	\$62.50
2969	42469	15.8	54	27	27	55% Linen 45% Rayon	CHINA	5309290000	\$62.50
2969	42470	8.7	54	27	27	100% Cotton	PERU	5208590000	\$53.50
2970	42471	19.1	54	9	9	100% Cotton Duck	TURKMENISTAN	5209510000	\$41.00
2970	42472	12.1	54	13.5	13.5	100% Cotton	USA	5209510000	\$53.50
2970	42473	7	54	13.5	13.5	100% Cotton	PERU	5209590000	\$65.50
2970	42474	7	54	6.25	6.75	100% Cotton	USA	5209410000	\$36.00
2970	42475	7	54	6.25	6.75	100% Cotton	USA	5209410000	\$36.00
2970	42476	7	54	6.25	6.75	100% Cotton Slub Duck	USA	5209410000	\$40.00
2970	42477	11	54	4.5	6.75	100% Cotton Duck	TURKMENISTAN	5209510000	\$38.50
2990	42478	9.4	54	25.25	13.5	75% Cotton 25% Linen	CHINA	5512.25.6090	\$55.00
2990	42479	14.6	54	27	27	55% Linen 45% Rayon	USA	5309.21.3090	\$63.50
2990	42480	13.3	54	27	27	100% Linen	CHINA	5309.24.4090	\$78.50
2990	42481	12.1	54	27	27	100% Cotton	USA	5209.51.6090	\$44.00
2990	42482	13.3	54	25.25	27	100% Linen	CHINA	5309.29.4090	\$78.50
2990	42483	16.4	54	25.25	27	100% Cotton	CHINA	5209.59.0090	\$70.00
2990	42484	11.5	54	13.5	13.5	100% Cotton	KOREA	5209.52.0020	\$60.00
2990	42485	16.2	54	26	27	55% Linen 45% Rayon	CHINA	5309.29.4010	\$60.00
2990	42486	15	54	27	26	100% Cotton	KOREA	5209.59.0090	\$75.00
2990	42487	13.3	54	36	27	100% Linen	CHINA	5309.29.4090	\$78.50
2995	42488	13.7	54	8.38	9	100% Cotton	CHINA	5209.39.0090	\$54.00
2997	42489	10.4	54	13.5	13.5	100% Cotton	USA	5209.51.6090	\$39.00
2997	42490	10.4	54	13.5	13.5	100% Cotton	USA	5209.51.6090	\$44.00
2997	42491	7.5	54	3.75	5.5	100% Linen	USA	5309.19.0010	\$65.00
2993	42492	7	54	6.25	1.75	100% Cotton	USA	5209.21.0000	\$31.50
2997	42493	7	54	3.25	3.25	100% Cotton	USA	5209.51.0000	\$31.50
2994	42494	7	54	3.25	3.25	100% Cotton Duck	USA	5209.51.6090	\$31.50

**Duralee
Retail Price List
(Limited Stock items excluded)**

Prices effective - July 1, 2016

Book	Pattern	Weight	Width	Vertical Repeat	Horizontal Repeat	Content	Origin	Tariff1	Retail
2995	42495	8	54	6.25	6.75	100% Cotton	USA	5209.21.0000	\$37.00
2993	42496	8	54	8.25	7.75	100% Cotton	USA	5209.51.0000	\$31.50
2995	42497	8	54	8.25	7.75	100% Cotton	USA	5209.51.0000	\$37.00
2995	42498	8.8	54	9	9	100% Cotton	SOUTH KOREA	5209.52.0020	\$60.00
2997	42499	9.6	54	12	13.5	100% Cotton	UAE	5209.59.0060	\$50.00
2995	42500	11.3	54	7	6.75	100% Cotton	TURKMENISTAN	5209.51.6090	\$35.00
2993	42501	8	54	8.25	13.75	100% Cotton	USA	5209.51.0000	\$31.50
2995	42502	8	54	8.25	13.75	100% Cotton	USA	5209.21.0000	\$37.00
2997	42503	8	54	0	4	100% Cotton	USA	5209.21.0000	\$37.00
2994	42504	8	54	0	3	100% Cotton	USA	5209.51.0000	\$37.00
3028	DE42505	12	54	27	13.5	75% Cotton 25% Linen	CHINA	5309.29.4090	\$71.50
3028	DE42506	15	54	18	13.5	100% Linen	USA	5309.11.0010	\$101.00
3028	DE42507	16	54	27.5	13.5	95% Cotton 5% Linen	USA	5209.19.0090	\$74.50
3028	DE42508	16	54	27	27	55% Cotton 45% Linen	USA	5212.21.6090	\$81.50
3028	DE42509	15	54	25.25	13.5	100% Cotton Slub Duck	USA	5209.19.0090	\$73.50
3028	DE42510	16	54	12.63	4.5	100% Cotton Slub Duck	USA	5209.19.0090	\$76.50
3028	DE42511	15	54	13.5	5.5	100% Cotton Slub Duck	USA	5209.19.0090	\$78.00
3028	DE42512	16	54	13.5	13.5	95% Cotton 5% Linen	USA	5209.19.0090	\$74.50
3028	DE42513	14	54	25.25	27	75% Cotton 25% Linen	CHINA	5309.29.4090	\$71.50
3028	DE42514	15	54	13.5	6.75	100% Cotton	USA	5209.19.0090	\$75.50
3028	DE42515	15	54	25.25	27	55% Cotton 45% Linen	USA	5512.21.6090	\$83.00
3028	DE42516	15	54	6.38	4.5	100% Cotton	USA	5209.19.0090	\$76.50
3053	SE42526	14	54	27	27	95% Cotton 5% Linen	USA	5209.19.0090	\$61.50
3053	SE42527	14	54	25.25	27	95% Cotton 5% Linen	USA	5209.19.0090	\$61.50
3053	SE42528	14	54	27	13.5	95% Cotton 5% Linen	USA	5209.19.0090	\$61.50
3053	SE42529	14	54	27	27	55% Linen 45% Rayon	CHINA	5309.29.4010	\$61.50
3053	SE42530	14	54	27	27	55% Linen 45% Rayon	CHINA	5309.29.4010	\$61.50
3053	SE42531	14	54	6.75	6.75	55% Linen 45% Rayon	CHINA	5309.29.4010	\$61.50
3053	SE42532	15	54	25.25	27	100% Cotton Ottoman	USA	5209.19.0090	\$61.50
3053	SE42533	14	54	25.25	27	100% Cotton	USA	5209.19.0090	\$61.50
3053	SE42534	14	54	4.5	6.75	100% Cotton Duck	USA	5209.19.0090	\$61.50
3068	DE42537	15	54	9	6.75	95% Cotton 5% Linen	USA	5209.19.0090	\$68.00
3068	DE42538	14	54	25.25	13.5	95% Cotton 5% Linen	USA	5209.19.0090	\$74.50
3068	DE42539	14	54	18	13.5	100% Cotton	USA	5209.19.0090	\$71.00
3068	DE42540	14	54	12.63	13.5	75% Cotton 25% Linen	USA	5309.21.0000	\$73.00
3068	DE42541	14	54	18	9	95% Cotton 5% Linen	USA	5209.19.0090	\$74.50
3068	DE42542	14	54	12.63	6.75	95% Cotton 5% Linen	USA	5209.19.0090	\$71.00
3068	DE42543	16	54	13.5	13.5	100% Cotton	USA	5209.19.0090	\$80.50
3068	DE42544	16	54	25.25	13.5	100% Cotton	USA	5209.19.0090	\$68.00
3068	DE42545	16	54	9	13.5	100% Cotton	USA	5209.19.0090	\$71.00
2773	50665	6	118	0	0	67% Polyester 33% Cotton	FRANCE	5515.12.9000	\$52.00
2773	50670	3.9	118	0	0	100% Polyester	CHINA	5407.61.9930	\$20.00
2773	50682	1.4	118	0	1.88	100% Polyester	TURKEY	5407.61.9930	\$56.00
2773	50713	2.4	118	0.88	2.88	70% Polyester 30% Nylon	CHINA	5407-52-2040	\$45.00
2922	50765	4.5	118	3	0	100% Polyester FR	TURKEY	5407.61.9930	\$59.00
2821	50768	3.7	118	1.75	0	100% Polyester FR	TURKEY	5407-61-0000	\$59.00
2922	50771	7	118	3	7.75	100% Polyester FR	TURKEY	5810.92.9980	\$84.00
2922	50774	6	118	8	0	100% Polyester FR	TURKEY	5407.61.9950	\$68.50
2821	50782	2.9	118	3	1	100% Polyester FR	TURKEY	5407.61.9950	\$61.50
2821	50786	8	118	6.63	2	100% Polyester FR	TURKEY	5407-61-0000	\$49.50
2922	50788	4.5	118	0	0	100% Polyester FR	CHINA	5407.61.9930	\$25.00
2705	50904	4.4	54	0.75	3.5	100% Linen	INDIA	5309.19.0090	\$97.50
2922	50926	5	118	0	0	100% Polyester FR	TURKEY	5407.61.9950	\$69.00
2922	50931	7	118	3.13	12	100% Polyester FR	TURKEY	5407.61.9930	\$91.00
2922	50933	5	118	4.25	4.38	100% Polyester FR	TURKEY	5407.52.2040	\$47.00
2745	50947	7	54	0.25	0.25	100% Polyester	TURKEY	6006.32.0080	\$32.50
2978	50999	7.3	54	15.5	16	50% Linen 50% Viscose	INDIA	5309.19.0010	\$98.00
2754	51001	20.3	50	21	25.5	100% Polyester	INDIA	5810.92.9090	\$88.00

**Duralee
Retail Price List
(Limited Stock items excluded)**

Prices effective - July 1, 2016

Book	Pattern	Weight	Width	Vertical Repeat	Horizontal Repeat	Content	Origin	Tariff1	Retail
2754	51002	5.4	54	0	0	100% Linen	BRAZIL	5309-19-0010	\$48.00
2978	51003	10.2	54	0	0	100% Linen	INDIA	5309.19.0010	\$54.00
2754	51004	5.1	54	15.5	13	100% Linen	INDIA	5309.19.0010	\$98.00
2754	51005	5.1	54	6.5	6	100% Linen	INDIA	5309.19.0010	\$93.00
2754	51006	6.9	54	7.5	13.5	100% Linen	INDIA	5309.19.0010	\$98.00
2768	51010	3.5	118	8.25	0	100% Polyester	TURKEY	5407-53-2020	\$50.50
2768	51011	3.5	118	0	0	100% Polyester	TURKEY	5407.69.4060	\$37.50
2768	51012	2.9	118	0	0	100% Polyester	TURKEY	5407-53-2020	\$62.50
2768	51013	3.5	118	0	0	100% Polyester	TURKEY	5407-53-2020	\$52.50
2768	51014	3.5	118	11.88	0	100% Polyester	TURKEY	5407.53.2020	\$58.00
2768	51016	3.5	118	0.25	0	100% Polyester	TURKEY	5407-53-2020	\$48.50
2768	51018	3.5	118	3.13	0	100% Polyester	TURKEY	5407.69.4060	\$50.50
2768	51019	3.5	118	13.88	0	100% Polyester	TURKEY	5407-53-2020	\$37.50
2768	51024	3.5	114	0	0	100% Polyester	MEXICO	5407-53-2020	\$39.50
2768	51027	3.5	114	3.13	0	100% Polyester	MEXICO	5407-53-2020	\$39.50
2768	51028	3.5	114	1.13	0	100% Polyester	TURKEY	5407-53-2020	\$37.50
2768	51030	3.5	118	0	0	100% Polyester	TURKEY	5407.53.2020	\$48.50
2768	51031	3.5	118	6.88	5.25	100% Polyester	TURKEY	5407-53-2020	\$75.00
2768	51032	3.5	118	0	0	100% Polyester	TURKEY	5407-53-2020	\$50.50
2768	51033	3.5	118	1.88	0	100% Polyester	TURKEY	5407-53-2020	\$56.50
2768	51034	3.5	118	1	0	100% Polyester	TURKEY	5407-53-2020	\$58.00
2768	51035	3.5	118	3.13	0	100% Polyester	TURKEY	5407-53-2020	\$49.00
2768	51036	3.5	118	1.75	0	100% Polyester	TURKEY	5407-53-2020	\$50.50
2768	51037	3.5	118	3.88	0	100% Polyester	TURKEY	5407-53-2020	\$50.50
2768	51038	3.5	118	0.13	0	100% Polyester	TURKEY	5407-53-2020	\$56.50
2768	51040	3.5	118	0.38	0	100% Polyester	TURKEY	5407-53-2020	\$59.00
2768	51042	4.4	118	4.75	11.75	100% Polyester	TURKEY	5407-53-2020	\$75.00
2768	51045	3.5	118	0.63	0	100% Polyester	TURKEY	5407-53-2020	\$54.50
2768	51046	3.5	###	2.13	0	100% Polyester	TURKEY	5407.69.4060	\$50.50
2768	51047	3.5	118	6.5	0	100% Polyester	TURKEY	5407-53-2020	\$49.50
2773	51055	8.7	118	0	0	100% Polyester	CHINA	5512.19.0090	\$42.00
2773	51058	3	118	0	0	100% Polyester	CHINA	5407.61.9930	\$15.50
2773	51061	2.3	118	0.5	0	100% Polyester	TURKEY	5407-61-9930	\$49.00
2773	51062	10.4	118	5	0	100% Polyester	TURKEY	5407.61.9930	\$64.00
2773	51063	2.5	118	1.5	0	100% Polyester	TURKEY	5407-61-9930	\$62.00
2773	51065	2.7	118	4	20	100% Polyester	TURKEY	5810-92-9050	\$72.00
2773	51066	1.7	118	8	4.38	100% Polyester	TURKEY	5810-92-9050	\$72.00
2773	51067	3.1	118	0	0	100% Polyester	TURKEY	5407.61.9930	\$15.50
2773	51068	4.3	118	0	0	100% Polyester	TURKEY	5407.61.9930	\$19.50
2773	51069	5.9	118	2.88	0	100% Polyester	TURKEY	5407-61-9930	\$45.00
2773	51071	3.8	118	8.13	0	100% Polyester	TURKEY	5407-61-9930	\$49.00
2773	51072	3	118	5.25	0	100% Polyester	TURKEY	5407.61.9930	\$49.50
2773	51073	4.5	118	0	0	90% Polyester 10% Lurex	TURKEY	5407.61.9930	\$50.00
2773	51074	4.3	118	4.13	0	100% Polyester	TURKEY	5407-61-9930	\$26.00
2773	51075	7	54	10.5	4.25	100% Polyester	TURKEY	5407-61-9925	\$55.00
2773	51077	17.1	58	12.5	13	100% Polyester	TURKEY	5407-52-2060	\$41.00
2773	51078	5.4	58	14.5	14.5	100% Polyester	TURKEY	5407-52-2020	\$34.50
2773	51080	4	118	0	1.13	100% Polyester	TURKEY	5407-61-9930	\$34.50
2773	51083	4.6	60	0	0	100% Polyester	TURKEY	5407-52-2020	\$20.00
2773	51086	6.7	60	3.13	6.25	100% Polyester	TURKEY	5407-52-2020	\$49.50
2773	51089	5.8	118	0.25	0	100% Polyester	CHINA	5407-61-9945	\$37.50
2773	51091	4.8	118	1.63	0	100% Polyester	CHINA	5801-36-0010	\$49.50
2773	51099	2	60	36	18	100% Polyester	CHINA	5407-61-9950	\$40.00
2773	51104	2.3	59	5.75	6	100% Polyester	CHINA	5407-52-2040	\$41.00
2773	51106	5.9	118	0.75	0	100% Polyester	FRANCE	5407.61.9945	\$40.50
2773	51111	4	118	1.88	0	100% Polyester	FRANCE	5407-61-3000	\$59.50
2773	51113	2.1	118	0	0	100% Polyester	TURKEY	5407-52-2040	\$35.00
2922	51116	5	118	0	0	100% Polyester FR	TURKEY	5407.61.9930	\$42.00

**Duralee
Retail Price List
(Limited Stock items excluded)**

Prices effective - July 1, 2016

Book	Pattern	Weight	Width	Vertical	Horizontal	Content	Origin	Tariff1	Retail
				Repeat	Repeat				
2922	51118	5	118	1.5	0	100% Polyester	TURKEY	5407.61.9930	\$54.50
2773	51121	4.5	59	0.5	0.5	100% Polyester	FRANCE	5407.61.9945	\$32.00
2773	51122	7.8	118	0	0	100% Polyester	TURKEY	5407-61-9930	\$58.50
2773	51123	5.8	118	0	0	100% Polyester	TURKEY	5407-61-9930	\$39.50
2773	51127	5	118	0.13	0	100% Polyester	FRANCE	5407.61.9945	\$75.50
2773	51128	7.6	118	0	0	85% Polyester 15% Linen	FRANCE	5515-12-9000	\$64.00
2773	51129	6	118	0	0	100% Polyester	TURKEY	5407-52-2020	\$49.50
2788	51131	9.2	57	11.75	12	100% Cotton	CHINA	5212-11-6060	\$78.50
2797	51132	6.7	56	0	1.25	80% Polyester 20% Linen	INDIA	5515.99.9020	\$35.00
2797	51134	6.7	56	0	0	80% Polyester 20% Linen	INDIA	5515.99.9020	\$35.00
2797	51135	6.7	56	3.5	0	80% Polyester 20% Linen	INDIA	5515.99.9020	\$59.00
2797	51138	5	54	0	0	53% Linen 35% Polyester 12% Cotton	INDIA	5309.29.3020	\$39.50
2797	51140	7.7	54	0	0	100% Cotton	INDIA	5208.32.3040	\$35.00
2820	51141	12.7	114	3.25	0	87% Linen 8% Viscose 5% Polyester	CHINA	5309-11-0010	\$79.00
2820	51142	14.3	114	4.25	0	88% Linen 12% Viscose	CHINA	5309-11-0010	\$79.00
2820	51143	12.7	114	4.5	4.5	92% Linen 8% Viscose	CHINA	5309-11-0010	\$79.00
2820	51144	15.4	114	10.25	0	80% Linen 15% Viscose 5% Polyester	CHINA	5309-21-4010	\$79.00
2820	51145	15	114	11.25	0	84% Linen 16% Viscose	CHINA	5309-21-4010	\$79.00
2820	51146	15	114	11	0	90% Linen 10% Viscose	CHINA	5309-11-0010	\$89.00
2820	51147	12	114	3.5	0	95% Linen 5% Polyester	CHINA	5309-11-0010	\$79.00
2820	51148	12	114	5.5	0	100% Linen	CHINA	5309-11-0010	\$72.00
2820	51149	12	114	10.25	0	100% Linen	CHINA	5309-19-0010	\$72.00
2820	51150	11.8	114	0	0	100% Linen	CHINA	5309-19-0010	\$72.00
2820	51151	19.5	114	0	0	67% Linen 27% Viscose 6% Polyester	CHINA	5309-21-4010	\$89.00
2820	51152	20.4	114	1.5	0	78% Linen 22% Viscose	CHINA	5309-21-4010	\$96.50
2820	51153	23.1	114	11.5	0	72% Linen 28% Viscose	CHINA	5309-21-4010	\$96.50
2820	51154	23.1	114	0.88	0	72% Linen 28% Viscose	CHINA	5309-21-4010	\$96.50
2820	51155	24.7	114	3.88	0	72% Linen 28% Viscose	CHINA	5309-21-4010	\$96.50
2820	51156	11.8	114	8.75	0	70% Linen 30% Viscose	CHINA	5309-11-0010	\$96.50
2820	51157	14.5	54	0	1.13	70% Linen 30% Cotton	INDIA	5309-29-4010	\$76.00
2820	51158	6.6	54	0	0	100% Linen	INDIA	5309-19-0010	\$76.50
2820	51159	9.6	54	0	0	100% Linen	INDIA	5309-19-0010	\$88.50
2820	51161	8.5	54	1.25	1	60% Linen 40% Cotton	INDIA	5309-29-4010	\$80.00
2820	51162	15	54	0	0	57% Linen 28% Cotton 15% Metallic	INDIA	5309-29-4010	\$79.00
2820	51163	5.4	54	0	0	100% Linen	INDIA	5309-19-0010	\$48.00
2820	51164	6	54	0	0	100% Linen	INDIA	5309-19-0010	\$60.50
2820	51166	9.6	54	0	0	100% Linen	INDIA	5309-19-0010	\$81.50
2820	51167	11.2	54	0	0	100% Linen	INDIA	5309-19-0010	\$76.50
2820	51168	10	54	0	0	100% Linen	INDIA	5309-19-0010	\$76.50
2820	51169	17.4	54	0	0	100% Linen	INDIA	5309-19-0010	\$89.00
2820	51172	7.1	54	0	0.75	100% Linen	INDIA	5309-19-0010	\$71.50
2820	51173	7.3	54	0	1.25	100% Linen	INDIA	5309-19-0010	\$71.50
2820	51174	10.6	54	0.25	0.25	72% Linen 28% Cotton	INDIA	5309-29-4010	\$79.00
2820	51175	7.7	54	0.75	0	70% Linen 30% Cotton	INDIA	5309-21-4010	\$68.50
2820	51176	10.8	54	0.5	0	80% Silk 20% Cotton	INDIA	5007-20-0065	\$71.50
2820	51177	16.2	54	0	0	58% Linen 42% Cotton	INDIA	5212-24-6090	\$79.00
2820	51178	17.2	54	0	0	60% Linen 40% Cotton	INDIA	5212-24-6090	\$84.00
2820	51179	15.2	54	0	0	58% Cotton 42% Linen	INDIA	5212-24-6090	\$76.50
2821	51182	5.8	118	10	7.63	100% Polyester FR	TURKEY	5407.53.2040	\$66.00
2821	51183	7.8	118	3.5	3.25	100% Polyester FR	TURKEY	5407.52.2040	\$55.50
2821	51184	6.7	118	2	8	100% Polyester FR	TURKEY	5407.52.2040	\$70.50
2821	51185	3.7	118	1.75	0.25	100% Polyester FR	TURKEY	5407.53.2040	\$57.50
2821	51186	4.2	118	10.25	0	100% Polyester FR	TURKEY	5407.52.2040	\$65.50
2821	51187	4.9	118	13.5	0	100% Polyester FR	TURKEY	5407.53.2040	\$67.00
2821	51188	6.3	118	9.75	3.75	100% Polyester FR	TURKEY	5407.53.0021	\$74.00
2821	51189	6.7	118	7	0	100% Polyester FR	TURKEY	5407-61-0000	\$60.50
2821	51190	7.9	118	12.25	5	100% Polyester FR	TURKEY	5407.52.2040	\$60.50
2821	51191	8.7	118	10	0	100% Polyester FR	TURKEY	5407-52-0000	\$70.50

**Duralee
Retail Price List
(Limited Stock items excluded)**

Prices effective - July 1, 2016

Book	Pattern	Weight	Width	Vertical		Content	Origin	Tariff1	Retail
				Repeat	Repeat				
2821	51192	8.4	118		4	0 100% Polyester FR	MEXICO	5407.61.9950	\$54.50
2821	51193	7.2	118		6	0 100% Polyester FR	MEXICO	5407.61.9950	\$57.00
2821	51194	3.9	118	24.75		43.5 65% Polyester 35% Rayon	TURKEY	5407-61-0000	\$84.00
2821	51195	9.3	###		15.5	15.5 100% Polyester FR	TURKEY	5407-61-0000	\$103.50
2821	51197	3.9	118		35	16.75 65% Polyester 35% Rayon	TURKEY	5407-61-0000	\$80.50
2821	51198	7.2	118	27.25		15.75 100% Polyester FR	TURKEY	5407-61-0000	\$77.50
2821	51199	6.8	118	6.25		14.25 100% Polyester FR	TURKEY	5407-10-0000	\$103.50
2821	51200	7.2	118	5.75		6 100% Polyester FR	TURKEY	5810.92.9080	\$88.50
2922	51201	5	118	11.25		11.5 100% Polyester FR	TURKEY	5407.53.2040	\$95.00
2821	51204	5.8	118		0	0 100% Polyester FR	TURKEY	5407-61-0000	\$62.50
2821	51205	6.4	118		0	0 100% Polyester FR	TURKEY	5407-61-0000	\$61.00
2821	51207	9.9	118		0	0 100% Polyester FR	MEXICO	5515.12.0090	\$52.00
2821	51208	3.6	118		0	0 100% Polyester FR	TURKEY	5407.53.2040	\$53.00
2821	51209	5.8	118		0	0 100% Polyester FR	TURKEY	5407-61-0000	\$59.50
2821	51210	12	118		0	14.75 100% Polyester FR	TURKEY	5407-61-0000	\$79.00
2821	51211	12	118		0	0 100% Polyester FR	TURKEY	5407-61-0000	\$83.50
2821	51212	7.8	118		0	0 100% Polyester FR	TURKEY	5810.92.9080	\$71.50
2821	51213	4.9	118	0.5		0.38 100% Polyester FR	TURKEY	5407.10.9030	\$74.00
2822	51214	6	58	1.75		2 100% Polyester	USA	6005-31-0080	\$39.00
2822	51215	6	58	7.75		3.38 100% Polyester	GERMANY	6005-31-0080	\$35.00
2822	51216	6	58	9.63		3.5 100% Polyester	GERMANY	6005-31-0080	\$35.00
2822	51217	5	58	11.5		14.75 100% Polyester	GERMANY	6005-31-0080	\$29.50
2822	51218	5	55	17.75		11.25 100% Polyester	CHINA	6005-31-0080	\$29.50
2822	51219	4.5	55	55.5		27.5 100% Polyester	CHINA	6005-31-0080	\$32.50
2822	51220	5	55	26.5		26.75 100% Polyester	CHINA	6005-31-0080	\$32.50
2822	51221	4	57	0.63		0.5 100% Polyester	USA	6005-31-0080	\$23.50
2822	51222	3	55	5.75		5 100% Polyester	CHINA	6005-31-0080	\$23.50
2822	51223	4	55	15.5		17.88 100% Polyester	Turkey	6005-31-0080	\$29.50
2822	51224	4	55	7.5		12.75 100% Polyester	Turkey	6005-31-0080	\$29.50
2822	51225	5	58	14.5		12.25 100% Polyester	CHINA	6005-31-0080	\$29.50
2822	51226	4	55	3.13		4 100% Polyester	Turkey	6005-31-0080	\$29.50
2822	51227	3.8	55	9.5		9 100% Polyester	Turkey	6005-31-0080	\$29.50
2830	51229	8.5	54		0	5.25 100% Polyester	INDIA	5407.61.9925	\$72.00
2861	51230	5.3	52.5	11.5		10.5 90% Linen 10% Viscose	CHINA	5810-92-9080	\$108.50
2861	51231	5.5	53	10.5		13 72% Linen 28% Cotton	CHINA	5801.91.0020	\$108.50
2861	51232	5.8	54	0.25		1.25 100% Linen	CHINA	5309.19.0010	\$113.00
2861	51233	6.4	54	6		2 100% Linen	CHINA	5309.19.0010	\$103.50
2861	51234	5.5	52	12		16.5 65% Linen 30% Nylon 5% Viscose	CHINA	5810.92.9080	\$108.50
2861	51236	5.3	52	3		6.38 78% Linen 17% Polyester 5% Cotton	CHINA	5810-92-9080	\$108.50
2861	51238	6.6	54	0		3.38 100% Linen	BRAZIL	5309.19.0090	\$58.50
2861	51239	4.9	53.75	11.75		10.75 70% Linen 22% Cotton 8% Plastic	CHINA	5810-92-9080	\$133.00
2861	51240	8.5	54	0.88		0 100% Linen	BRAZIL	5309-19-0090	\$58.50
2861	51241	5.6	54	0		0 100% Linen	BRAZIL	5309-19-0010	\$53.50
2861	51242	4.4	55	0		0 100% Linen	CHINA	5309.19.0010	\$67.50
2861	51244	5.3	52	0.5		0.5 80% Linen 20% Rayon	CHINA	5810.92.9080	\$125.50
2874	51245	7.5	54	0		0 100% Polyester	India	5512.19.0005	\$40.50
2874	51246	13.8	54	0		0 100% Polyester	Turkey	5407.52.2060	\$40.50
2874	51247	9.7	54	0		0 100% Polyester	India	5407.61.9935	\$47.50
2874	51248	8.7	60	0		0 100% Polyester	Turkey	5407.53.2020	\$35.50
2897	51249	4	111	3.13		7 100% Polyester	TURKEY	5810.92.9080	\$70.50
2897	51250	4	118		3	0 100% Polyester	TURKEY	5407.61.9925	\$30.50
2897	51251	3.1	118	3.75		0 100% Polyester	TURKEY	5407.52.2020	\$32.50
2897	51252	6.4	###		0.5	0.5 100% Polyester	TURKEY	5407.61.9925	\$40.50
2897	51253	4.3	111	2.25		3.25 100% Polyester	TURKEY	5810.92.9080	\$70.50
2897	51254	3	118	0.5		0 100% Polyester	TURKEY	5407.61.9925	\$25.50
2897	51255	3.2	118	0		0 100% Polyester	TURKEY	5407.52.2020	\$30.50
2897	51256	4	108	4.25		21.5 100% Polyester	TURKEY	5810.92.9050	\$75.50
2897	51257	5.1	118	0		0 100% Polyester	TURKEY	5512.19.0090	\$70.50

**Duralee
Retail Price List
(Limited Stock items excluded)**

Prices effective - July 1, 2016

Book	Pattern	Weight	Width	Vertical Repeat	Horizontal Repeat	Content	Origin	Tariff1	Retail
2897	51258	6.8	118		0	0 87% Polyester 13% Linen	TURKEY	5407.53.2020	\$60.50
2897	51259	8.1	118		0	0 100% Polyester	TURKEY	5512.19.0090	\$75.00
2897	51260	2.9	118		0	0 100% Polyester	TURKEY	5407.61.9930	\$25.50
2897	51261	3	118	3.5		0 100% Polyester	TURKEY	5407.61.9925	\$25.50
2897	51262	6.6	118		0	0 100% Polyester	TURKEY	5407.61.9930	\$50.00
2897	51263	5.1	118		0	0 100% Polyester	TURKEY	5407.69.2010	\$50.50
2897	51264	4.8	118	0.5		0 100% Polyester	TURKEY	5407.53.2040	\$55.50
2897	51265	8.1	118		0	0 100% Polyester	TURKEY	5515.11.0090	\$60.50
2897	51266	4.8	118		0	0 100% Polyester	TURKEY	5407.52.2020	\$35.00
2897	51267	3.1	118	1.25		0 100% Polyester	TURKEY	5407.52.2020	\$31.50
2897	51268	3.1	118		0	0 100% Polyester	TURKEY	5407.52.2020	\$30.50
2897	51269	4.5	111	4	19.25	100% Polyester	TURKEY	5810.92.9050	\$82.50
2897	51270	2.1	118		0	0 100% Polyester	TURKEY	5407.61.9950	\$31.50
2897	51272	21.7	118		0	0 100% Polyester	TURKEY	5407.52.2020	\$50.50
2897	51273	3.6	112	8.5	18	100% Polyester	TURKEY	5407.61.9925	\$77.50
2897	51274	4.4	118		0	0 100% Polyester	TURKEY	5407.52.2020	\$50.50
2897	51275	11.5	118	0.75		0 100% Polyester	TURKEY	5407.52.2020	\$60.50
2897	51276	4.1	118		0	0 100% Polyester	TURKEY	5512.19.0090	\$30.50
2897	51277	10.7	118	0.75	0.75	100% Polyester	TURKEY	5407.52.2060	\$62.00
2897	51278	4.9	118		0	0 100% Polyester	TURKEY	5512.19.0090	\$40.50
2897	51279	4.2	118		0	0 100% Polyester	Turkey	5515.12.0022	\$15.50
2897	51280	4.2	118		0	0 100% Polyester	Turkey	5515.12.0022	\$18.00
2897	51281	3	118		0	0 100% Polyester	Turkey	5407.52.2020	\$30.50
2897	51282	1.7	118	4		0 100% Polyester	Turkey	5407.53.2020	\$45.50
2897	51283	2.7	118		0	0 100% Polyester	Turkey	5407.61.9930	\$12.00
2897	51284	2.6	118		0	0 100% Polyester	Turkey	5407-61-9930	\$14.50
2911	51285	14.6	104	9.5	5.25	100% Polyester	GERMANY	6005.32.0010	\$106.50
2911	51286	13.1	118	0.75	0.75	100% Polyester	GERMANY	6005.32.0010	\$86.50
2911	51287	16.7	104	6	5	100% Polyester	GERMANY	6005.32.0010	\$106.50
2911	51288	12.8	118	6.13	3.38	100% Polyester	GERMANY	6005.32.0010	\$79.00
2911	51289	7.7	114	27	12	100% Polyester	TURKEY	6005.32.0010	\$111.50
2911	51290	10.7	114	8	7	100% Polyester	TURKEY	6005.32.0010	\$111.50
2911	51291	9.8	116	0.75	1	100% Polyester	GERMANY	6005.32.0010	\$79.00
2911	51292	12.1	116	6.63	5.75	100% Polyester	GERMANY	6005.32.0010	\$106.50
2911	51293	5.7	56	4	8	100% Polyester	TURKEY	6005.32.0010	\$59.00
2911	51294	4.6	54	13	13.5	100% Polyester	TURKEY	6005.32.0010	\$59.00
2911	51295	8.9	56	16	9	100% Polyester	TURKEY	6005.32.0010	\$44.00
2911	51296	17.3	54	1	2	100% Polyester	INDIA	5810.10.0000	\$106.50
2911	51297	18.3	54	1	1	100% Polyester	INDIA	5810.10.0000	\$106.50
2911	51298	6.8	56	10	6.5	100% Polyester	TURKEY	6005.32.0010	\$44.00
2912	51299	9.2	55	0	2.38	100% Polyester	INDIA	5407.93.1000	\$44.00
2912	51300	13.3	55	0	2.5	100% Polyester	INDIA	5512.19.0090	\$55.00
2912	51301	8.4	57	0	0.5	57% Polyester 43% Acrylic	TURKEY	5512.99.0090	\$56.50
2912	51302	19	54	0	0	100% Polyester	INDIA	5512.19.0090	\$62.50
2912	51303	10	55	0	1.5	100% Polyester	INDIA	5515.12.0090	\$44.00
2912	51304	15.5	54	0	0	100% Polyester	INDIA	5515.12.0090	\$62.50
2912	51305	9.2	55	0	1	100% Polyester	INDIA	5512.19.0090	\$44.00
2912	51306	11.1	55	1	1.88	83% Polyester 17% Linen	TURKEY	5515.19.0090	\$54.00
2912	51307	14	54	0	0	100% Linen	INDIA	5309.19.0010	\$70.50
2912	51308	12.8	55	0	3	100% Polyester	INDIA	5512.19.0090	\$49.00
2912	51309	10.5	54	0	0	100% Polyester	INDIA	5512.19.0005	\$51.50
2922	51310	6.3	118	6.75	0	100% Polyester	TURKEY	5407.61.9945	\$65.50
2922	51311	4	118	5	12	100% Polyester	CHINA	5407.53.2040	\$30.50
2922	51312	6.4	118	0.25	0	100% Polyester	TURKEY	5407.61.9975	\$50.50
2922	51313	4	118	20.5	20	100% Polyester	CHINA	5407.53.2040	\$30.50
2922	51314	4	118	12.5	21.5	100% Polyester	CHINA	5407.53.2040	\$30.50
2922	51316	6.5	118	2.25	0	100% Polyester	TURKEY	5407.61.9930	\$69.00
2922	51317	5	118	0	0	100% Polyester	TURKEY	5407.52.2040	\$60.50

**Duralee
Retail Price List
(Limited Stock items excluded)**

Prices effective - July 1, 2016

Book	Pattern	Weight	Width	Vertical Repeat	Horizontal Repeat	Content	Origin	Tariff1	Retail
2922	51318	5	118		0	0 100% Polyester	TURKEY	5407.61.9975	\$60.50
2922	51319	4	118	6.25	7.38	100% Polyester	CHINA	5407.53.2040	\$30.50
2922	51320	8	118		9	0 100% Polyester	TURKEY	5407.53.2040	\$65.50
2922	51321	8	118		0	0 100% Polyester	TURKEY	5407.61.9930	\$55.50
2922	51322	5	118		0	0 100% Polyester	TURKEY	5407.53.2020	\$60.50
2922	51323	4	118	1.38	1.75	100% Polyester	CHINA	5407.53.2040	\$30.50
2922	51324	6.5	118		2	0 100% Polyester	TURKEY	5407.61.9930	\$55.50
2922	51325	7.6	118		0	0 100% Polyester	TURKEY	5407.52.2040	\$85.50
2922	51327	5	118		0	0 100% Polyester	TURKEY	5407.61.9930	\$60.50
2922	51328	5	118	0.63		0 100% Polyester	TURKEY	5407.10.0010	\$60.50
2922	51329	9	118		10	0 100% Polyester	TURKEY	5407.61.9930	\$55.50
2922	51330	6	118		10	0 100% Polyester	TURKEY	5407.61.9945	\$60.50
2922	51331	5	118	9.5		0 100% Polyester	TURKEY	5407.53.2040	\$65.50
2922	51332	5	118	9.5	0.25	100% Polyester	TURKEY	5407.53.2040	\$65.50
2922	51333	10	118		2	0 100% Polyester	TURKEY	5407.52.2040	\$70.50
2922	51334	9	118		8	0 100% Polyester	TURKEY	5407.61.9930	\$65.50
2922	51335	8.4	118	1.13		0 100% Polyester	TURKEY	5407.61.9930	\$70.50
2922	51336	4	118	0.25		0 100% Polyester	TURKEY	5407.10.0010	\$60.50
2922	51337	5	118	7.25		0 100% Polyester	TURKEY	5407.61.9945	\$65.50
2922	51338	5	118		0	0 100% Polyester	TURKEY	5407.52.2040	\$60.50
2922	51339	4	118	21.5	23	100% Polyester	CHINA	5407.53.2040	\$30.50
2929	51340	2.3	118		2	0 100% Polyester	TURKEY	5407.53.2020	\$54.00
2929	51341	4.6	118	6.25	5.88	100% Polyester	TURKEY	5407.53.2020	\$75.00
2929	51342	3.9	118	18.25	11.25	100% Polyester	TURKEY	5407.53.2020	\$70.00
2929	51343	4.3	118		4	0 100% Polyester	TURKEY	5407.53.2020	\$39.50
2929	51344	7.4	108	13	13.75	100% Polyester	TURKEY	5407.53.2020	\$95.00
2929	51345	3.4	105	6.25	4.5	100% Polyester	TURKEY	5407.53.2020	\$80.50
2929	51346	9	118		0	0 100% Polyester	TURKEY	5407.53.2020	\$70.00
2929	51347	1.9	118	3.75		0 100% Polyester	TURKEY	5407.53.2020	\$42.50
2929	51348	2.8	118	0.5		0 100% Polyester	TURKEY	5407.53.2020	\$50.00
2929	51349	2.4	118	1.88		0 100% Polyester	TURKEY	5407.53.2020	\$53.00
2929	51350	9.6	118		0	0 100% Polyester	TURKEY	5407.53.2020	\$68.00
2929	51351	3	118	4.88	3.75	100% Polyester	TURKEY	5407.53.2020	\$55.00
2929	51352	3.8	118	54.75		0 100% Polyester	TURKEY	5407.53.2020	\$58.00
2929	51353	3.9	100	4	8	100% Polyester	TURKEY	5407.53.2020	\$85.00
2929	51354	6.6	108	6.13	12	100% Polyester	TURKEY	5407.53.2020	\$85.00
2929	51355	3.3	118	2.88		0 100% Polyester	TURKEY	5407.53.2020	\$40.50
2929	51356	3.7	118		0	0 100% Polyester	TURKEY	5407.53.2020	\$65.50
2929	51357	5.1	118	4	6.5	100% Polyester	TURKEY	5407.53.2020	\$75.00
2929	51358	3.8	118	3.5		0 100% Polyester	TURKEY	5407.53.2020	\$65.00
2929	51359	4.8	118	1.38		0 100% Polyester	TURKEY	5407.53.2020	\$70.00
2929	51360	4.5	118	1.25		0 100% Polyester	TURKEY	5407.53.2020	\$63.00
2929	51361	7.2	118		4	0 98% Polyester 2% Linen	TURKEY	5407.53.2020	\$63.00
2929	51362	2.3	118	2.13		0 100% Polyester	TURKEY	5407.53.2020	\$58.00
2929	51363	2.7	100	4	8	100% Polyester	TURKEY	5407.53.2020	\$80.50
2929	51364	2.2	118	0.5		0 100% Polyester	TURKEY	5407.53.2020	\$53.00
2929	51365	2.3	118	5.13		0 100% Polyester	TURKEY	5407.53.2020	\$54.50
2929	51366	2.3	118	0.25	0.25	100% Polyester	TURKEY	5407.53.2020	\$50.00
2929	51367	2.9	118		0	0 100% Polyester	TURKEY	5407.53.2020	\$52.00
2929	51368	3.8	118	26.5		0 100% Polyester	TURKEY	5407.53.2020	\$58.00
2929	51369	5.1	118	5.75	23.25	100% Polyester	TURKEY	5407.53.2020	\$80.00
2929	51370	4.2	118	4.13		0 100% Polyester	TURKEY	5407.53.2020	\$40.50
2929	51371	4.2	118		0	0 100% Polyester	TURKEY	5407.53.2020	\$70.00
2929	51372	3.8	118	5		0 100% Polyester	TURKEY	5407.53.2020	\$65.50
2929	51373	4.3	118		0	0 100% Polyester	TURKEY	5407.53.2020	\$35.50
2929	51374	2.9	118	0.13		0 100% Polyester	TURKEY	5407.53.2020	\$68.00
2929	51375	4.4	118	4.75	11.75	100% Polyester	TURKEY	5407.53.2020	\$75.50
2929	51376	5.1	118	13.38	11.5	100% Polyester	TURKEY	5407.53.2020	\$80.00

**Duralee
Retail Price List
(Limited Stock items excluded)**

Prices effective - July 1, 2016

Book	Pattern	Weight	Width	Vertical		Content	Origin	Tariff1	Retail
				Repeat	Repeat				
2978	51377	8.1	54		0	0 91% Linen 9% Polyester	TURKEY	5309190000	\$77.50
2978	51378	5.2	53	17		26.5 48% Linen 27% Polyester 25% Acrylic	CHINA	5810920000	\$82.50
2978	51379	5.9	54	0		0.75 53% Linen 32% Cotton 15% Polyester	INDIA	5309290000	\$48.50
2978	51380	5.9	54	0		2.25 45% Linen 26% Cotton 18% Viscose 11% Polyester	INDIA	5309290000	\$48.50
2978	51381	6.2	54	0		1 43% Linen 40% Cotton 17% Polyester	INDIA	5309290000	\$48.50
2978	51382	7.3	54	0		2.25 37% Linen 31% Viscose 22% Cotton 10% Polyester	INDIA	5309290000	\$48.50
2978	51383	6.4	54	0.75		3 75% Polyester 25% Linen	INDIA	5515199000	\$92.50
2978	51384	5.2	59	5.5		4 100% Polyester	TURKEY	5047530023	\$48.50
2978	51385	6.4	54	1		3 75% Polyester 25% Linen	INDIA	5515199000	\$106.00
2987	51386	12.2	59	22.25		16 100% Sunbrella Acrylic	USA	5512.29.0090	\$126.50
2987	51387	6.3	54	0		0 100% Sunbrella Acrylic	USA	5512.21.0000	\$50.00
2987	51388	6.3	54	0		0 100% Sunbrella Acrylic	USA	5512.29.0000	\$71.00
2987	51389	10.4	59	0.13		2.13 100% Sunbrella Acrylic	USA	5512.29.0090	\$92.50
2987	51390	9	59	6		3.38 100% Sunbrella Acrylic	USA	5512.29.0090	\$87.00
2987	51391	8.6	59	3.75		3.75 100% Sunbrella Acrylic	USA	5512.29.0090	\$80.50
2987	51392	7.2	54	0		0 100% Sunbrella Acrylic	USA	5512.21.0000	\$56.00
3003	51393	6.6	54	1.5		1 100% Linen	INDIA	5309.11.0100	\$63.50
3003	51394	6.4	53	3.88		4.5 69% Linen 31% Viscose	INDIA	5309.19.0010	\$107.50
3003	51395	6.9	52	10		8.5 42% Polyester 36% Linen 22% Cotton	INDIA	5309.29.4010	\$107.50
3003	51396	4.9	54	6.5		2.5 90% Linen 10% Cotton	INDIA	5309.19.0010	\$54.00
3003	51397	6	53	3.75		3.75 64% Linen 36% Viscose	INDIA	5309.19.0010	\$107.50
3003	51398	4.4	54	1		0 90% Linen 10% Polyester	INDIA	5309.11.0010	\$54.00
3003	51399	7.2	53	15.5		25.75 61% Linen 39% Viscose	INDIA	5309.11.0010	\$112.50
3003	51400	9.4	52.75	8.75		7.75 72% Linen 28% Acrylic	CHINA	5810.92.1000	\$112.50
3003	51401	7.6	53	2.5		4 96% Linen 4% Polyester	INDIA	5309.19.0010	\$93.00
3003	51402	4.4	54	0		1 100% Linen	INDIA	5309.11.0010	\$49.00
3003	51403	4	54	0		2.38 100% Linen	INDIA	5309.11.0010	\$58.50
3003	51404	4.4	54	0.75		3.5 100% Linen	INDIA	5309.19.0090	\$98.00
3003	51405	7	52	9.5		13 39% Linen 38% Polyester 23% Cotton	INDIA	5309.29.4010	\$107.50
3003	51406	4.9	52	2.25		4 51% Linen 30% Cotton 19% Polyester	INDIA	5309.29.4010	\$107.50
3003	51407	4.4	54	0		0 85% Linen 15% Lurex	INDIA	5309.11.0010	\$63.50
3003	51408	5.4	53	3		3 94% Linen 6% Polyester	INDIA	5309.19.0010	\$63.50
3003	51409	10.2	54	0		0 100% Linen	INDIA	5309.11.0010	\$83.00
3003	51410	4.4	54	0		0.38 100% Linen	INDIA	5309.11.0010	\$49.00
3003	51411	5.4	54	0		0 100% Linen	INDIA	5309.19.0010	\$49.00
3017	DK61158	14.4	55	0		0 52% Cotton 48% Polyester	INDIA	5211.39.0090	\$35.00
3017	DK61159	15.9	55	0		0 52% Cotton 48% Polyester	INDIA	5211.39.0090	\$35.00
3017	DK61160	14.2	55	0		0 79% Cotton 21% Polyester	INDIA	5211.39.0090	\$40.00
3020	DK61161	12	54	0		0 100% Polyester FR	TAIWAN	5515.12.9000	\$50.50
3020	DK61162	7.9	54	0		0 100% Polyester FR	INDIA	5407.53.2060	\$50.00
3023	DW61163	12.4	54	6.75		6.75 65% Wool 20% Nylon 15% Viscose	CHINA	5111.19.1000	\$84.00
3023	DW61164	12.4	54	4.75		4.5 65% Wool 20% Nylon 15% Viscose	CHINA	5111.19.1000	\$84.00
3023	DW61165	12.4	54	4.75		4.5 65% Wool 20% Nylon 15% Viscose	CHINA	5111.19.1000	\$84.00
3023	DW61166	12.4	54	8.25		6.75 65% Wool 20% Nylon 15% Viscose	CHINA	5111.19.1000	\$84.00
3023	DW61167	12.4	54	0		0 65% Wool 20% Nylon 15% Viscose	CHINA	5111.19.1000	\$84.00
3023	DW61168	12.4	54	2.25		2.13 65% Wool 20% Nylon 15% Viscose	CHINA	5111.19.1000	\$84.00
3023	DW61169	12.4	54	2.38		2.25 65% Wool 20% Nylon 15% Viscose	CHINA	5111.19.1000	\$84.00
3024	DW61170	23.5	55	0		0 58% Polyester 38% Viscose 4% Linen	CHINA	5801.36.0020	\$73.50
3024	DW61171	30.2	55	0		0 83% Polyester 17% Acrylic	CHINA	5801.36.0010	\$78.00
3024	DW61172	15.8	55	0		0 100% Polyester	CHINA	5801.36.0020	\$49.00
3024	DW61173	21.6	54	0		0 73% Polyester 27% Acrylic	CHINA	5801.36.0010	\$73.50
3024	DW61174	19	54	0.25		1 100% Cotton	INDIA	5209.49.0090	\$68.50
3024	DW61175	24.3	54	0		0 52% Polyester 42% Viscose 6% Cotton	CHINA	5407.93.2090	\$78.50
3024	DW61176	12.6	56	0		0 100% Polyester	CHINA	5801.36.0010	\$54.00
3025	DW61177	21.6	56	0		0 100% Polyester	CHINA	5801.36.0010	\$68.50
3026	DP61178	9.9	55	27.5		27.5 90% Cotton 10% Linen	CHINA	5209.59.0090	\$65.00
3026	DP61179	14.2	54	27		27 100% Cotton	SPAIN	5209.59.0090	\$73.50
3026	DP61180	14.2	54	27		27 100% Cotton	SPAIN	5209.59.0090	\$73.50

**Duralee
Retail Price List
(Limited Stock items excluded)**

Prices effective - July 1, 2016

Book	Pattern	Weight	Width	Vertical	Horizontal	Content	Origin	Tariff1	Retail
				Repeat	Repeat				
3025	DW61181	15.3	55		0	0 100% Polyester	CHINA	5801.36.0020	\$63.50
3026	DP61182	6.3	56	18		13.5 100% Cotton	TURKMENISTAN	5208.51.4020	\$50.00
3026	DP61183	8.8	54	18		9 100% Cotton	TURKMENISTAN	5209.59.0060	\$40.00
3026	DP61184	8.8	54	18		9 100% Cotton	TURKMENISTAN	5209.51.6090	\$40.00
3026	DP61185	8.8	54	6.75	6.75	100% Cotton	TURKMENISTAN	5209.51.6090	\$40.00
3026	DW61186	13	55	13.5		13.75 69% Cotton 31% Polyester	CHINA	5211.49.0020	\$65.00
3026	DW61187	14.8	54	13.5		13.5 62% Rayon 38% Polyester	CHINA	5516.23.0090	\$63.50
3026	DW61188	9.2	56	14.5		14.75 74% Polyester 26% Cotton	CHINA	5514.30.3310	\$49.00
3026	DW61189	9.2	58	16.5		9 60% Cotton 40% Polyester	CHINA	5211.49.0020	\$67.50
3018	DA61190	19.9	52	6.38		6.38 78% Polyester 22% Linen	INDIA	5407.92.2090	\$112.50
3018	DA61191	11.8	54	6.38		13.5 70% Polyester 30% Cotton	INDIA	5407.82.0090	\$78.50
3018	DA61192	18.8	52	6.38		6.38 76% Polyester 24% Linen	INDIA	5407.92.2090	\$112.50
3059	DA61193	11.9	50.5	6.13		10.13 52% Cotton 48% Polyester	INDIA	5211.39.0090	\$100.00
3059	DA61194	9.3	51	9		6.5 67% Polyester 24% Cotton9% Rayon	INDIA	5514.23.0090	\$100.00
3059	DA61195	11.9	51.5	9.25		8.63 40% Polyester 33% Cotton27% Viscose	INDIA	5211.39.0090	\$100.00
3018	DA61196	17.3	54	8.5		5 100% Cotton	INDIA	5209.31.6035	\$95.00
3018	DA61197	14.4	52	4		3.75 85% Cotton 12% Polyester3% Zari	INDIA	5209.31.6035	\$90.00
3019	DW61200	23.9	55	13.38		14 100% Polyester	CHINA	5801.36.0020	\$71.90
3019	DW61201	19.9	54	17		13.5 60% Cotton 40% Polyester	CHINA	5211.49.0020	\$83.00
3019	DW61202	21.2	55	36.63		28.5 45% Rayon 41% Polyester 14% Cotton	CHINA	5515.91.0090	\$83.00
3019	DW61203	21.2	54	11		6.75 92% Polyester 8% Rayon	CHINA	5801.36.0020	\$68.50
3019	DW61204	16	55	14.38		14.75 35% Rayon 30% Polyester 20% Cotton 15% Linen	CHINA	5515.91.0090	\$73.50
3019	DW61205	18.2	57	9		14.75 100% Polyester	CHINA	5516.93.0020	\$50.00
3019	DV61206	11.8	54	32.5		25.25 100% Cotton	CHINA	5801.25.0020	\$88.00
3019	DP61207	10.8	54	25.25		27 100% Cotton	PERU	5209.59.0090	\$54.00
3019	DP61208	14.7	54	12.63		9 100% Cotton	USA	5209.59.0090	\$54.00
3040	DW61221	14.1	54	0		0 100% Linen	CHINA	5309.19.0010	\$96.00
3040	DW61222	21.1	54	0		1 100% Linen	CHINA	5309.19.0010	\$96.00
3040	DW61223	17.8	56	0		5 68% Cotton 22% Rayon 8% Linen 2% Polyester	CHINA	5211.49.0090	\$55.00
3040	DW61224	16.3	56	0		4.75 70% Cotton 21% Rayon 8% Linen 1% Polyester	CHINA	5211.49.0090	\$65.00
3027	DP61225	13.6	54	12.63		13.5 100% Cotton	UNITED ARAB	5209.11.0020	\$45.00
3027	DP61226	13.6	54	25.25		18 100% Cotton	UNITED ARAB	5209.11.0020	\$45.00
3027	DP61227	15.5	54	25.25		13.5 80% Cotton 20% Linen	PAKISTAN	5212.21.6040	\$45.00
3027	DP61228	15.5	54	8.38		8.5 80% Cotton 20% Linen	PAKISTAN	5212.21.6040	\$45.00
3027	DP61229	13.6	54	12.63		13.5 100% Cotton	UNITED ARAB	5209.11.0020	\$45.00
3027	DP61230	13.6	54	25.25		27 100% Cotton	UNITED ARAB	5209.11.0020	\$45.00
3027	DP61231	15.5	54	25.25		27 80% Cotton 20% Linen	PAKISTAN	5212.21.6040	\$45.00
3027	DP61232	13.6	54	18		13.5 100% Cotton	UNITED ARAB	5209.11.0020	\$45.00
3027	DP61233	13.5	54	18		13.5 80% Cotton 20% Linen	PAKISTAN	5212.21.6040	\$45.00
3027	DP61234	15.5	54	12.63		13.5 80% Cotton 20% Linen	PAKISTAN	5212.21.6040	\$45.00
3027	DK61235	15.5	54	0		0 80% Cotton 20% Linen	PAKISTAN	5212.21.6040	\$40.00
3027	DK61236	14.8	55	0		0 95% Polyester 5% Linen	CHINA	5512.19.0090	\$40.00
3027	DK61237	13.6	54	0		0 100% Cotton	UNITED ARAB	5209.11.0020	\$40.00
3044	DS61247	4	118	7		0 100% Polyester	TURKEY	5407.61.9930	\$65.00
3044	DS61248	7.6	118	11		23 100% Polyester	TURKEY	5407.69.2010	\$100.00
3044	DS61249	3.5	118	21.5		0 100% Polyester	TURKEY	5407.69.2010	\$60.00
3044	DS61250	11.3	118	8		0 100% Polyester	TURKEY	5407.52.2040	\$70.00
3044	DS61251	11	118	0		0 100% Polyester	TURKEY	5407.52.2040	\$60.00
3044	DS61252	3	118	9.5		8 100% Polyester	TURKEY	5407.53.2040	\$80.00
3044	DS61253	11.5	118	11		8 100% Polyester	TURKEY	5407.53.2040	\$80.00
3044	DS61254	3.8	118	22		16 100% Polyester	TURKEY	5407.61.9970	\$100.00
3044	DS61255	14.5	118	8.5		0 100% Polyester	TURKEY	5407.61.9970	\$75.00
3044	DS61256	6.8	118	13		0 100% Polyester	TURKEY	5407.61.9930	\$90.00
3044	DS61257	5	118	0		0 100% Polyester	TURKEY	5407.61.9930	\$50.00
3044	DS61258	5.3	118	25		31 100% Polyester	TURKEY	5407.69.2010	\$65.00
3044	DS61259	9	118	0		0 100% Polyester	TURKEY	5407.69.2010	\$60.00
3044	DS61260	9	118	0		0 100% Polyester	TURKEY	5407.53.2040	\$60.00
3044	DS61261	8	118	0		0 100% Polyester	TURKEY	5407.69.2010	\$70.00

**Duralee
Retail Price List
(Limited Stock items excluded)**

Prices effective - July 1, 2016

Book	Pattern	Weight	Width	Vertical		Content	Origin	Tariff1	Retail
				Repeat	Repeat				
3044	DS61262	15	118	0.5	1.5	100% Polyester	TURKEY	5407.69.2010	\$95.00
3044	DS61263	9	118	4	0	100% Polyester	TURKEY	5407.53.2040	\$75.00
3044	DS61264	5	118	0	0	100% Polyester	TURKEY	5407.69.2010	\$95.00
3044	DS61265	11	118	0.25	0.25	100% Polyester	TURKEY	5407.69.2010	\$70.00
3044	DS61266	12.5	118	25	30	100% Polyester	TURKEY	5407.61.9970	\$80.00
3044	DS61267	6.5	118	15.5	15.5	100% Polyester	TURKEY	5407.69.1020	\$90.00
3044	DS61268	12	118	0	0	100% Polyester	TURKEY	5407.53.2020	\$65.00
3044	DS61269	3.4	118	7.5	7.75	100% Polyester	TURKEY	5407.53.2040	\$100.00
3044	DS61270	5.2	118	4	0	100% Polyester	TURKEY	5407.69.2010	\$60.00
3044	DS61271	4.1	118	3.25	6	100% Polyester	TURKEY	5513.29.0090	\$85.00
3044	DS61272	10.3	118	1.5	0.13	100% Polyester	TURKEY	5407.53.2040	\$100.00
3044	DS61273	13.2	118	0	0	100% Polyester	TURKEY	5407.69.2010	\$55.00
3044	DS61274	6.2	118	4.75	0	100% Polyester	TURKEY	5407.61.9930	\$90.00
3035	DK61275	14.4	54	0	0	82% Polyester 18% Cotton	TAIWAN	5407.82.0090	\$45.00
3035	DK61276	15	54	0	0	51% Cotton 49% Polyester	TAIWAN	5211.39.0040	\$45.00
3037	DM61278	19.3	54	9	9	100% Polyester	INDIA	5512.19.0005	\$73.50
3037	DM61279	19.3	54	3.38	3.38	100% Polyester	INDIA	5512.19.0005	\$73.50
3037	DM61280	19.3	54	1.63	1.63	100% Polyester	INDIA	5512.19.0005	\$73.50
3037	DK61281	19.3	54	0	0	100% Polyester	INDIA	5512.19.0005	\$73.50
3037	DJ61282	19.3	54	0	3.38	100% Polyester	INDIA	5512.19.0005	\$73.50
3037	DJ61283	19.3	54	0	1.63	100% Polyester	INDIA	5512.19.0005	\$73.50
3044	DS61284	6	118	0	0	100% Polyester	TURKEY	5407.61.9930	\$52.50
3044	DS61285	5	118	0	0	100% Polyester	TURKEY	5407.61.9930	\$67.50
3044	DS61286	4.5	118	0	0	100% Polyester	CHINA	5407.61.9930	\$25.00
3044	DS61287	4.5	118	0	0	100% Polyester	CHINA	5407.61.9930	\$22.50
3044	DS61288	5	118	0	0	100% Polyester	TURKEY	5407.61.9930	\$42.50
3044	DS61289	7.6	118	1.25	0	100% Polyester	TURKEY	5407.52.2040	\$70.00
3044	DS61290	6.3	118	0.38	0	100% Polyester	TURKEY	5407.61.9930	\$90.00
3044	DS61291	7.6	118	0	0	100% Polyester	TURKEY	5407.52.2040	\$85.00
3044	DS61292	8	118	0.13	0	100% Polyester	TURKEY	5407.61.9930	\$70.00
3053	SA61293	8.5	52	23.63	23.63	68% Polyester 29% Linen 3% Rayon	CHINA	5515.19.0090	\$99.50
3056	DA61295	11.6	51	7.25	8.25	56% Viscose 44% Polyester	INDIA	5810.92.9080	\$117.00
3056	DA61296	19.9	55.5	4.38	6	69% Rayon 17% Linen 11% Polyester 3% Cotton	CHINA	5516.91.0090	\$114.50
3046	DT61297	0.1	0.25	0	0	65% Polyester 35% Cotton	CHINA	5808.90.0090	\$12.00
3046	DT61298	0.1	0.75	0	0	71% Viscose 29% Rayon	CHINA	5808.90.0090	\$10.50
3046	DT61299	0.1	1.63	0	0	99% Viscose 1% Polyester	CHINA	5808.90.0090	\$18.00
3042	DP61300	13.3	54	25.25	27	100% Linen	CHINA	5309.29.4090	\$83.00
3042	DP61301	13.3	54	25.25	27	100% Linen	CHINA	5309.29.4090	\$83.00
3042	DP61302	7.7	54	25.25	27	100% Cotton	PERU	5208.59.1000	\$58.50
3042	DP61303	10	54	25.25	13.5	100% Cotton	USA	5209.52.0020	\$44.00
3042	DP61304	9.5	54	27	13.5	55% Linen 45% Rayon	CHINA	5309.29.4010	\$65.00
3042	DP61305	9.5	54	27	13.5	55% Linen 45% Rayon	CHINA	5309.29.4010	\$65.00
3042	DP61306	17.5	54	27	13.5	55% Linen 45% Rayon	CHINA	5309.29.4010	\$70.00
3043	DP61307	10.3	54	0	6.75	100% Cotton	USA	5209.51.6090	\$34.50
3043	DP61308	12.1	54	18	10.75	100% Cotton	USA	5209.59.0060	\$49.00
3043	DP61309	10.3	54	25.25	13.5	100% Cotton	USA	5209.51.6090	\$39.00
3043	DP61310	12.4	54	6.38	13.5	89% Cotton 11% Rayon	USA	5209.11.0090	\$58.50
3043	DP61311	12.4	54	32	27	89% Cotton 11% Rayon	USA	5209.11.0090	\$58.50
3043	DP61312	10.3	54	18	27	100% Cotton	USA	5209.51.6090	\$39.00
3043	DP61313	12.1	54	13.5	13.5	100% Cotton	USA	5209.51.6090	\$54.00
3043	DP61314	12.4	54	13.5	13.5	89% Cotton 11% Rayon	USA	5209.11.0090	\$58.50
3043	DP61315	10.3	54	18	9	100% Cotton	USA	5209.51.6090	\$39.00
3043	DP61316	10.3	54	27	27	100% Cotton	USA	5209.51.6090	\$44.00
3043	DP61317	18.8	54	27	27	90% Cotton 5% Flax 5% Rayon	USA	5209.59.0090	\$63.50
3043	DP61318	14.6	54	36	27	55% Linen 45% Rayon	USA	5309.21.3090	\$63.50
3043	DP61319	14.6	54	25.25	13.5	55% Linen 45% Rayon	USA	5309.21.3090	\$63.50
3043	DP61320	10.4	54	25.25	13.5	100% Cotton	USA	5209.51.6090	\$39.00
3043	DP61321	14.6	54	36	27	55% Linen 45% Rayon	USA	5309.21.3090	\$63.50

**Duralee
Retail Price List
(Limited Stock items excluded)**

Prices effective - July 1, 2016

Book	Pattern	Weight	Width	Vertical		Content	Origin	Tariff1	Retail
				Repeat	Repeat				
3043	DP61322	9.5	54	27	27	4.5 55% Linen 45% Rayon	CHINA	5309.29.4010	\$65.00
3043	DP61323	11.3	54	27	27	13.5 100% Cotton	TURKMENISTAN	5209.51.6090	\$40.00
3043	DP61324	17.3	54	18	18	9 100% Cotton	U.A.E.	5209.59.0090	\$52.50
3043	DP61325	19.2	54	26.5	13.5	100% Cotton	PAKISTAN	5209.59.0090	\$60.00
3043	DJ61326	10.4	54	0	0	0.13 100% Cotton	PORTUGAL	5209.41.6020	\$43.00
3043	DM61327	21.7	54	3.38	3.38	100% Cotton	CHINA	5209.41.6020	\$68.50
3045	DI61328	12	55	14	14.25	100% Cotton	INDIA	5209.31.6035	\$50.00
3045	DI61329	12	55	21.5	14	100% Cotton	INDIA	5208.39.4090	\$50.00
3045	DI61330	12	55	8	7	100% Cotton	INDIA	5209.31.6035	\$50.00
3043	DA61331	19.9	52	4.38	4.25	37% Viscose 21% Cotton 21% Linen 21% Polyester	INDIA	5810.92.9080	\$108.00
3043	DA61332	22.2	52	4.75	6.5	100% Polyester	INDIA	5407.52.2060	\$108.00
3043	DA61333	19.1	52	6.38	10.38	77% Polyester 23% Linen	INDIA	5514.23.0090	\$108.00
3045	DJ61334	12	55	0	3	100% Cotton	INDIA	5209.31.6035	\$50.00
3050	DP61336	9.4	54	18	17.5	75% Cotton 25% Linen	CHINA	5211.59.0090	\$67.50
3050	DP61337	8.3	56	27	27	55% Viscose 45% Linen	KOREA	5309.29.4010	\$62.50
3050	DP61338	8.3	56	25.25	27	55% Linen 45% Viscose	KOREA	5309.29.4010	\$62.50
3050	DP61339	12.4	54	25.25	27	89% Cotton 11% Rayon	USA	5209.59.0090	\$58.50
3050	DP61340	10.3	54	27	27	100% Cotton	USA	5209.51.6090	\$39.00
3050	DP61341	14.6	54	25.25	27	55% Linen 45% Rayon	USA	5309.21.3090	\$63.50
3050	DP61342	7.7	54	25.25	13.5	100% Cotton	PERU	5208.59.1000	\$58.50
3050	DP61344	13	54	26	27	100% Cotton	U.A.E	5209.59.0090	\$52.50
3050	DP61345	15.8	54	13	9	55% Linen 45% Rayon	CHINA	5309.29.4010	\$60.00
3050	DP61346	16.2	54	26	27	55% Linen 45% Rayon	CHINA	5309.29.4010	\$62.50
3050	DP61347	16.2	54	13.5	13.5	55% Linen 45% Rayon	CHINA	5309.29.4010	\$62.50
3051	DI61348	15.9	57	18.25	9.38	100% Polyester	INDIA	5407.53.2060	\$50.00
3051	DJ61349	13	55	0	5.38	100% Polyester	TURKEY	5407.61.9955	\$65.00
3051	DI61350	14	55	27.63	10.88	65% Polyester 26% Cotton 9% Rayon	TURKEY	5407.83.0090	\$65.00
3051	DI61351	12.8	54	11.38	13.5	50% Polyester 37% Cotton 13% Rayon	TURKEY	5407.83.0090	\$65.00
3051	DI61352	13.8	57	7.75	9.38	100% Polyester	INDIA	5407.53.2060	\$55.00
3051	DI61353	15.9	54	7	6	100% Polyester	INDIA	5407.52.2060	\$50.00
3059	DA61354	17.6	52	9	13	100% Polyester	INDIA	5407.69.2060	\$110.00
3059	DA61355	21.9	53	5.75	17	60% Polyester 30% Rayon 10% Linen	CHINA	5810.99.9000	\$100.00
3059	DA61356	16.5	52	9.5	13.38	58% Polyester 42% Cotton	INDIA	5514.21.0090	\$137.00
3059	DA61357	14	53	13.5	11.75	68% Cotton 32% Rayon	CHINA	5209.31.6035	\$80.00
3059	DA61358	25	52	13	9.5	57% Polyester 30% Linen 13% Viscose	INDIA	5407.92.2090	\$120.00
3059	DA61359	14.5	54	12.75	13	97% Cotton 3% Viscose	INDIA	5209.39.0040	\$85.00
3059	DA61360	17	51	6.25	8.5	54% Cotton 46% Polyester	INDIA	5211.39.0090	\$105.00
3059	DA61361	17	52	9.38	26	52% Cotton 48% Polyester	INDIA	5211.39.0090	\$100.00
3059	DA61362	17	52	6.13	8.75	64% Cotton 36% Polyester	INDIA	5514.23.0090	\$110.00
3059	DA61363	17	53	8.88	13.25	42% Polyester 38% Cotton 20% Viscose	INDIA	5514.23.0090	\$100.00
3059	DA61364	17	52	12.5	17.13	90% Polyester 10% Viscose	INDIA	5407.52.2060	\$100.00
3066	DA61367	9	52	3.88	3.75	65% Cotton 35% Polyester	CHINA	5810.91.0000	\$50.00
3062	DJ61368	8.5	54	0	27	70% Cotton 30% Polyester	USA	5210.59.6090	\$55.00
3063	DP61369	13.3	54	12.63	13.38	55% Linen 45% Rayon	CHINA	5309.29.4010	\$60.00
3066	DK61370	15	54	0	0	100% Polyester	INDIA	5512.19.0005	\$50.00
3065	DJ61371	13	54	0	6.75	52% Cotton 48% Polyester	TAIWAN	5211.49.0090	\$50.00
3066	DI61372	13	57	5.13	3.13	100% Polyester	INDIA	5407.69.3000	\$55.00
3066	DK61373	11.2	58	0	0	100% Polyester	CHINA	5407.53.2060	\$60.00
3063	DI61374	9.7	57	3.5	3.5	65% Cotton 35% Polyester	CHINA	5211.49.0020	\$60.00
3066	DI61375	11.5	54	1.75	2	72% Cotton 28% Polyester	CHINA	5211.49.0090	\$69.00
3066	DM61376	9.2	54	3.13	2.75	100% Cotton	TURKEY	5209.49.0090	\$70.00
3066	DI61377	10.2	55	3.75	3.5	58% Cotton 42% Polyester	TURKEY	5211.49.0020	\$72.50
3063	DJ61378	13.7	54	0	6.75	100% Cotton	INDIA	5209.39.0090	\$50.00
3063	DP61379	11.3	55	9.63	6	70% Cotton 30% Polyester	CHINA	5211.59.0090	\$60.00
3061	DP61380	8	54	4.25	9	100% Cotton	USA	5209.31.0000	\$29.50
3066	DI61381	18.3	54	2.75	6.75	50% Polyester 43% Cotton 7% Linen	INDIA	5514.23.0090	\$68.50
3066	DK61382	7	54	0	0	85% Polyester 15% Cotton	INDIA	5408.32.9090	\$50.00
3062	DI61383	11.5	54	2.5	2.5	61% Rayon 39% Polyester	CHINA	5408.33.9090	\$60.00

Duralee
Retail Price List
(Limited Stock items excluded)

Prices effective - July 1, 2016

Book	Pattern	Weight	Width	Vertical	Horizontal	Content	Origin	Tariff1	Retail
				Repeat	Repeat				
3065	DI61384	7.5	57	5.5	6.75	51% Cotton 21% Polyester16% Metal 12% Nylon	CHINA	5210.49.4020	\$55.00
3066	DJ61385	11.5	54	0	2.75	100% Cotton	TAIWAN	5209.41.6020	\$60.00
3066	DA61386	8.5	54	4.5	4.5	70% Polyester 30% Cotton	INDIA	5514.21.0090	\$75.00
3063	DP61387	7	54	12.5	27	100% Cotton Duck	USA	5209.41.0000	\$29.50
3062	DP61388	6.5	54	6.25	6.25	100% Cotton	USA	5208.52.0000	\$29.50
3063	DP61389	8	54	10	5.25	100% Cotton	USA	5209.51.0000	\$29.50
3063	DP61390	6.5	54	1	1	100% Cotton	USA	5208.52.0000	\$39.50
3063	DP61391	7	54	1	1	100% Cotton Duck	USA	5209.51.0000	\$39.50
3066	DP61392	7	54	8.25	9	100% Cotton Duck	USA	5209.51.0000	\$29.50
3066	DP61393	6.5	54	8.25	9	100% Cotton	USA	5208.52.0000	\$29.50
3062	DI61394	11.2	56	7.5	7	75% Rayon 25% Polyester	CHINA	5801.36.0010	\$50.00
3062	DA61395	11.9	54	11	13.63	100% Cotton	CHINA	5209.31.6035	\$65.00
3065	DI61396	11.3	54	0	0	100% Polyester	INDIA	5512.19.0090	\$65.00
3064	DI61397	13.1	54	1.75	1	57% Polyester 43% Cotton	INDIA	5514.23.0090	\$64.00
3063	DI61398	14.4	54	9.38	6.75	83% Polyester 17% Cotton	INDIA	5514.23.0090	\$70.00
3063	DA61399	13.1	54	4.5	6.5	97% Cotton 3% Viscose	INDIA	5209.39.0040	\$85.00
3066	DK61400	13.7	54	0	0	53% Cotton 47% Polyester	INDIA	5407.83.0090	\$64.00
3066	DI61401	19	56	0.25	0.25	65% Polyester 35% Cotton	INDIA	5514.30.3310	\$65.00
3065	DI61402	19	58	0.25	1	100% Polyester	MEXICO	5515.12.0090	\$65.00
3065	DA61403	19.5	50	12.38	8.38	56% Cotton 38% Polyester6% Other	INDIA	5514.30.3390	\$100.00
3066	DM61404	20	54	6.75	6.75	80% Polyester 20% Linen	CHINA	5515.99.9005	\$65.00
3065	DI61405	15	55	4.5	4.5	80% Polyester 12% Linen 8% Cotton	INDIA	5515.99.9090	\$62.50
3065	DI61406	15	55	8.88	13.63	80% Polyester 12% Linen 8% Cotton	INDIA	5515.99.9090	\$62.50
3065	DQ61407	8.2	55	0	0	100% Polyester	TURKEY	5407.69.3000	\$65.00
3063	DJ61408	19	54	0	3.25	54% Cotton 28% Polyester18% Rayon	INDIA	5211.49.0020	\$62.50
3066	DA61409	17	51	2.25	2.63	51% Cotton 49% Polyester	INDIA	5211.39.0090	\$100.00
3066	DA61410	18	51	3.13	4.25	53% Cotton 47% Polyester	INDIA	5211.39.0090	\$100.00
3063	DP61411	12	54	9	9	100% Cotton	TURKMENISTAN	5209.51.6090	\$40.00
3066	DP61412	11.5	54	6.75	6.75	100% Cotton	PAKISTAN	5209.52.0020	\$40.00
3062	DP61413	11.3	55	4.5	3.5	100% Cotton Duck	TURKMENISTAN	5209.51.6090	\$40.00
3063	DP61414	11.3	54	6.25	4.5	100% Cotton	TURKMENISTAN	5209.51.6090	\$40.00
3066	DI61415	12	55	13.75	4.5	58% Polyester 42% Cotton	INDIA	5407.82.0090	\$60.00
3066	DA61416	12.1	51	1.88	2	62% Polyester 29% Cotton9% Linen	INDIA	5810.92.9000	\$60.00
3066	DA61417	12.3	51	10	8.75	70% Polyester 30% Cotton	INDIA	5810.92.9000	\$75.00
3063	DA61418	21.2	51	6.25	6.5	53% Polyester 47% Cotton	INDIA	5810.92.9000	\$75.00
3066	DI61419	17	55	4.5	4.75	68% Cotton 32% Polyester	CHINA	5211.11.0000	\$40.00
3066	DQ61420	7	55	0	0	100% Polyester	INDIA	5407.53.2040	\$45.00
3065	DK61421	13	54	0	0	59% Polyester 41% Cotton	INDIA	5407.82.0090	\$35.00
3066	DK61422	15	54	0	0	60% Cotton 40% Polyester	TAIWAN	5211.39.0090	\$35.00
5017	71006	18.6	55	3.5	7	100% Polyester	CHINA	5407.61.9955	\$72.50
2722	71023	17.1	57	27.5	27	67% Rayon 33% Polyester	CHINA	5903.90.2500	\$70.00
2721	71024	14.8	57	31	14.5	42% Cotton 38% Polyester20% Rayon	CHINA	5407.83.0090	\$59.50
2721	71025	14.8	57	1.69	4.5	42% Cotton 38% Polyester20% Rayon	CHINA	5407.83.0090	\$59.50
2721	71026	13.4	57	7.25	7.25	100% Polyester	CHINA	5903.90.2500	\$58.00
2722	71027	13.2	57	3.37	3.37	100% Polyester	CHINA	5407.61.9955	\$56.50
2722	71028	15.9	54	0	0	64% Rayon 36% Polyester	CHINA	5903.90.2500	\$58.50
2722	71029	18.1	54	1.75	1.75	55% Rayon 45% Polyester	CHINA	5903.90.2500	\$60.00
2722	71030	13.4	54	4.13	2.38	74% Rayon 26% Polyester	CHINA	5903.90.2500	\$57.00
2722	71031	17.8	54	0	6.63	57% Polyester 43% Cotton	CHINA	5903.90.2500	\$51.00
2721	71032	18.1	54	0.5	0.5	55% Rayon 45% Polyester	CHINA	5903.90.2500	\$59.00
2796	71033	14.6	57	1.75	6.75	55% Rayon 45% Polyester	CHINA	5516.23.0090	\$59.00
2794	71034	17.4	57	11	13.5	50% Cotton 30% Polyester20% Rayon	CHINA	5407.83.0090	\$61.50
2795	71035	17.1	57	14.75	13.5	67% Rayon 33% Polyester	CHINA	5516.23.0090	\$71.50
2796	71036	23.8	56	9.25	9.5	59% Cotton 41% Polypropylene	TURKEY	5211-49-0020	\$77.50
2796	71037	23.3	54	4.5	4.75	64% Cotton 36% Polyester	TURKEY	5211-49-0020	\$76.50
2796	71038	17.4	54	0	9	100% Cotton	TURKEY	5209-43-0030	\$69.50
2796	71039	17.8	58	20	30	71% Rayon 17% Polyester 12% Cotton	CHINA	5516.23.0090	\$71.50
2796	71040	14.8	54	0	0	100% Polyester	CHINA	5407.61.9955	\$63.50

**Duralee
Retail Price List
(Limited Stock items excluded)**

Prices effective - July 1, 2016

Book	Pattern	Weight	Width	Vertical	Horizontal	Content	Origin	Tariff1	Retail
				Repeat	Repeat				
2796	71041	16.5	54	2.25	2.25	67% Polyester 33% Rayon	CHINA	5407.93.2090	\$73.50
2794	71042	18.1	54	3	2.75	55% Rayon 45% Polyester	CHINA	5903.90.2500	\$60.00
2795	71043	13.4	54	4.13	2.38	74% Rayon 26% Polyester	CHINA	5903.90.2500	\$59.00
2796	71044	15.9	54	0	0	64% Rayon 36% Polyester	CHINA	5903.90.2500	\$59.00
2796	71045	13.9	54	0	0	100% Polyester	CHINA	5407.61.99.55	\$63.50
2836	71046	9.3	54	1.38	0.63	55% Rayon 45% Polyester	CHINA	5516.23.0090	\$44.00
2836	71047	24.7	54	7.25	7.5	100% Polyester	CHINA	5407.61.9955	\$64.50
2836	71048	22	57	6.38	14.75	100% Polyester	CHINA	5407.61.9955	\$62.00
2836	71049	17.1	57	4.88	3.5	67% Rayon 33% Polyester	CHINA	5516.23.0090	\$68.00
2836	71050	9.1	54	12.25	14.25	100% Polyester	TURKEY	5407-93-2090	\$72.50
2836	71052	11.5	55	27.5	14.25	100% Polyester	TURKEY	5407-93-2090	\$79.50
2836	71053	12.9	57.5	0	0	100% Polyester	CHINA	5407.93.2090	\$53.50
2835	71054	24.3	54	1.25	1	100% Polyester	CHINA	5903.90.2500	\$74.00
2836	71055	14.3	54	8.5	7	60% Rayon 40% Polyester	CHINA	5211.49.0020	\$57.00
2836	71056	16.2	54	0.75	1.13	100% Polyester	CHINA	5903.90.2500	\$66.00
2836	71057	8.7	57	31.63	15	42% Polyester 30% Cotton28% Rayon	CHINA	5407.83.0090	\$52.00
5018	71058	19.5	57	0.88	0.75	46% Rayon 30% Polyester 24% Cotton	CHINA	5516.23.0090	\$60.00
5018	71059	22	57	8.88	9.88	100% Polyester	CHINA	5515.12.0090	\$51.00
5018	71060	20.1	54	27	15	100% Polyester	CHINA	5407.61.9955	\$63.00
5018	71061	17.1	57	8	7.25	67% Rayon 33% Polyester	CHINA	5516.23.0090	\$65.50
5018	71062	8.1	54	7.13	0	74% Polyester 26% Acrylic	TURKEY	5801.36.0010	\$62.50
5018	71063	17.4	55	4	3.5	47% Polyester 32% Acrylic21% Rayon	CHINA	5515.21.0090	\$58.50
5018	71064	9.9	57	16.13	15.25	65% Polyester 35% Cotton	CHINA	5407.83.0090	\$57.00
5018	71065	9.3	55	9.5	14.5	77% Polyester 23% Rayon	CHINA	5407.93.2090	\$58.50
5018	71066	14.4	55	5.5	9.5	100% Polyester	CHINA	5407.61.9955	\$79.50
5018	71067	11	55	3.5	7	100% Polyester	CHINA	5407.61.9955	\$72.50
2920	71068	18.5	57	0	0	66% Polyester 34% Cotton	CHINA	5407.83.0090	\$43.50
2957	71069	24.3	55	0	0	80% Rayon 20% Polyester	CHINA	5801.36.0010	\$69.50
2920	71070	12.7	55	0	0	95% Polyester 5% Rayon	CHINA	5903.90.2500	\$47.00
2956	71071	15.4	55	0	0	100% Polyester	CHINA	5407.52.2060	\$47.50
2957	71072	14.6	55	10	4.75	46% Rayon 30% Polyester 24% Cotton	CHINA	5516239900	\$56.00
2957	71073	17.1	56	5.38	3.63	100% Polyester	CHINA	5801360000	\$61.00
2957	71074	13.2	57	14	14.5	50% Polyester 50% Rayon	CHINA	5516239900	\$65.50
2956	71075	18	55	13.63	9.5	100% Polyester	CHINA	5515129000	\$58.00
2956	71076	15.2	55	7.88	3.5	100% Polyester	CHINA	5801360000	\$64.00
2956	71078	11.3	55	15	15	100% Polyester	CHINA	5515129000	\$56.00
2956	71079	15.2	55	7.88	3.75	50% Polyester 35% Rayon 15% Cotton	CHINA	5515129000	\$57.00
2985	71086	14.4	54	14.5	14.75	100% Polyester	CHINA	5407.61.9950	\$59.50
2985	71091	17	55	0	6.13	54% Polyester 46% Rayon	CHINA	5407.93.2090	\$73.50
2985	71092	9.9	57	2.75	14.75	100% Polyester	CHINA	5512.19.0090	\$59.50
3031	71093	25	55	0.75	0.75	100% Polyester	CHINA	5515.12.0090	\$59.50
2985	71094	14.4	57	2.13	1.5	100% Polyester	CHINA	5407.93.2090	\$59.50
2985	71095	15.4	55	0	0.63	56% Rayon 44% Polyester	CHINA	5516.23.0090	\$71.50
2985	71096	28.1	57	28	14.25	100% Polyester	CHINA	5512.19.0090	\$79.50
2985	71097	18.7	57	7.5	7.25	100% Polyester	CHINA	5407.61.9955	\$64.50
2985	71098	21	57	4.88	3.25	100% Polyester	CHINA	5903.20.2500	\$59.50
2984	71099	13.6	59	11.25	7.63	73% Rayon 27% Polyester	CHINA	5903.20.2500	\$61.50
2984	71100	13.6	59	17.13	15.13	73% Rayon 27% Polyester	CHINA	5903.20.2500	\$61.50
2984	71101	13.6	59	9.5	15.38	73% Rayon 27% Polyester	CHINA	5903.20.2500	\$61.50
2984	71102	13.6	59	28.5	30.63	73% Rayon 27% Polyester	CHINA	5903.20.2500	\$61.50
2984	71103	13.6	59	0	7.63	73% Rayon 27% Polyester	CHINA	5903.20.2500	\$61.50
2984	71104	13.6	59	15	15.38	73% Rayon 27% Polyester	CHINA	5903.20.2500	\$61.50
3031	71111	21.9	57	1.88	3.63	100% Polyester	CHINA	5407.69.4060	\$59.50
3031	71113	20	57	1	1	100% Polyester	CHINA	5407.69.4060	\$59.50
3031	71114	16.3	57	1.25	1.25	100% Polyester	CHINA	5407.69.4060	\$59.50
3031	71115	16.3	57	6.75	6.75	100% Polyester	CHINA	5512.19.0090	\$60.00
3031	71116	20.7	56.5	2.13	2.38	100% Polyester	CHINA	5512.19.0090	\$76.00
2721	72031	16	54	18	27.25	55% Cotton 45% Linen	USA	5311.00.4020	\$66.00

**Duralee
Retail Price List
(Limited Stock items excluded)**

Prices effective - July 1, 2016

Book	Pattern	Weight	Width	Vertical Repeat	Horizontal Repeat	Content	Origin	Tariff1	Retail
2722	72032	16	54	25.25		27 55% Cotton 45% Linen	USA	5212.25.6090	\$66.00
2722	72033	16	54	0		9 55% Cotton 45% Linen	USA	5212.25.6090	\$66.00
2795	72048	12	54	27		27 100% Pima Cotton Sateen	USA	5209.19.0020	\$76.00
2795	72049	12	54	12.5	13.5	100% Cotton Ottoman	USA	5209.59.0090	\$77.00
2795	72050	12	54	27		27 95% Cotton 5% Linen	USA	5212.25.6090	\$64.50
2794	72051	12	54	18	13.5	55% Linen 45% Rayon	USA	5309.29.4010	\$80.00
2794	72052	12	54	25.25	13.5	55% Linen 45% Rayon	USA	5309.29.4010	\$80.00
2794	72053	12	54	13.5	13.5	95% Cotton 5% Linen	USA	5212.25.6090	\$69.50
2796	72054	12	54	13.5	13.5	95% Cotton 5% Linen	USA	5212.25.6090	\$73.00
2796	72055	12	54	13.5	13.5	95% Cotton 5% Linen	USA	5212.25.6090	\$72.00
2796	72056	12	54	25.25	27	55% Linen 45% Rayon	USA	5309.29.4010	\$79.50
2836	72058	12	54	18	13.5	55% Linen 45% Rayon	USA	5309.29.4010	\$84.00
2836	72059	12	54	27	27	55% Cotton 45% Linen	USA	5212.25.6090	\$77.50
2836	72060	12	54	12.63	27	100% Cotton	USA	5209.59.0090	\$77.00
2836	72061	12	54	27	27	100% Cotton	USA	5209.59.0090	\$70.50
2836	72062	12	54	18	9	55% Cotton 45% Linen	USA	5212.25.6090	\$76.50
2836	72063	12	54	27	13.5	95% Cotton 5% Linen	USA	5212.25.6090	\$66.50
2836	72064	12	54	27	27	55% Linen 45% Rayon	USA	5309.29.4010	\$77.00
2836	72065	12	54	25.25	27	55% Linen 45% Rayon	USA	5309.29.4010	\$78.00
2836	72066	12	54	18	27	100% Cotton Slub Duck	USA	5209.51.6090	\$76.50
2836	72067	12	54	2.25	3.38	100% Cotton Duck	USA	5209.51.6090	\$68.50
5018	72077	14	54	13.5	6.75	100% Cotton Slub Duck	USA	5209.19.0090	\$61.50
5018	72078	14	54	13.5	9	100% Cotton Slub Duck	USA	5209.19.0090	\$62.50
5018	72079	16	54	12.5	13.5	100% Cotton	USA	5209.59.0040	\$58.50
5018	72080	14	54	13.5	13.5	100% Cotton Slub Duck	USA	5209.19.0090	\$59.50
5018	72081	14	54	27	54	100% Cotton Duck	USA	5209.51.6090	\$71.00
5018	72082	14	54	18	54	100% Cotton Slub Duck	USA	5209.19.0090	\$69.00
5018	72083	14	54	0	9	100% Cotton Duck	USA	5209.51.6090	\$52.50
5018	72084	14	54	18	18	95% Cotton 5% Linen	USA	5212.25.6090	\$59.50
5018	72085	16	54	25	27	100% Cotton	USA	5209.19.0090	\$56.50
2956	72087	12	54	8.38	18	55% Linen 45% Rayon	CHINA	5309290000	\$61.50
2956	72088	12	54	25.25	24.88	55% Linen 45% Rayon	CHINA	5309290000	\$61.50
2956	72089	12	54	12.63	18	95% Cotton 5% Linen	USA	5209190000	\$61.50
2956	72090	12	54	25.25	27	44% Cotton 31% Linen 25%Rayon	CHINA	5212259000	\$61.50
2956	72091	12	54	13.5	13.63	100% Cotton China Twill	USA	5209120000	\$61.50
2957	72092	12	54	9	9	100% Cotton China Twill	USA	5209120000	\$61.50
2957	72093	12	54	27	27	100% Cotton China Twill	USA	5209120000	\$61.50
2957	72094	12	54	26.5	27	100% Cotton China Twill	USA	5209120000	\$61.50
2957	72095	12	54	25.25	27	100% Cotton China Twill	USA	5209120000	\$61.50
3022	72109	12	54	9	13.5	100% Cotton	PAKISTAN	5209.12.0020	\$60.00
3022	72110	14	54	12.63	13.5	100% Cotton Slub Duck	USA	5209.19.0090	\$72.00
3022	SE72111	14	54	18	13.5	95% Cotton 5% Linen	USA	5209.19.0090	\$80.50
3021	SE72112	10.9	55	8.5	4.5	55% Linen 45% Rayon	CHINA	5309.29.4010	\$80.50
3021	72113	14	54	13.5	9	95% Cotton 5% Linen	USA	5209.19.0090	\$80.50
3021	SE72114	10.9	54	25.25	9	55% Cotton 45% Rayon	CHINA	5309.29.4010	\$78.50
3022	72115	14	54	6.75	6.75	100% Cotton China Twill	PAKISTAN	5209.12.0020	\$60.00
3021	SE72116	14	54	27	13.5	95% Cotton 5% Linen	USA	5209.19.0090	\$78.50
2836	73011	19.5	54	0	0	100% Polyester	CHINA	5407.61.9955	\$59.50
2836	73013	19.5	54	0	0	100% Polyester	CHINA	5407.61.9955	\$59.50
2722	73014	11.6	54	15.38	14	55% Linen 45% Cotton	CHINA	5810.99.9000	\$68.00
2721	73015	11.7	52	6	4.88	55% Linen 45% Cotton	CHINA	5810.99.9000	\$67.50
2775	73016	12	55	1.13	1.13	65% Cotton 35% Polyester	TURKEY	5211.39.0090	\$55.00
2775	73017	12	55	0	0	65% Cotton 35% Polyester	TURKEY	5211.39.0090	\$55.00
2775	73018	12	55	9.38	4.5	65% Cotton 35% Polyester	ISRAEL	5212.23.6090	\$55.00
2775	73019	12	55	1	4.38	65% Cotton 35% Polyester	TURKEY	5212.23.6090	\$55.00
2775	73020	12	55	14	17.75	65% Cotton 35% Polyester	TURKEY	5211.39.0090	\$55.00
3002	73021	11.6	52	7.88	7.38	45% Linen 37% Cotton 18%Rayon	CHINA	5810.99.9000	\$72.50
3002	73022	11.6	52	7.88	21.88	45% Linen 37% Cotton 18%Rayon	CHINA	5810.99.9000	\$72.50

Duralee
Retail Price List
(Limited Stock items excluded)

Prices effective - July 1, 2016

Book	Pattern	Weight	Width	Vertical		Content	Origin	Tariff1	Retail
				Repeat	Repeat				
3002	73023	11.7	53		6	3.38 45% Linen 37% Cotton 18%Rayon	CHINA	5810.99.9000	\$67.50
3002	73024	7.6	53.5		4	4 63% Cotton 19% Rayon 18%Linen	CHINA	5810.91.0010	\$74.50
2836	73025	7.6	54	11.88		6 78% Cotton 22% Linen	CHINA	5810.91.0010	\$65.50
2842	73026	12.8	59		6.75	6.75 55% Cotton 28% Polyester17% Viscose	TURKEY	5211-49-0020	\$65.50
2842	73027	6.6	58		5.5	4.5 55% Cotton 28% Polyester17% Viscose	TURKEY	5211-49-0020	\$65.50
2842	73028	6.6	58		0	1.75 55% Cotton 28% Polyester17% Viscose	TURKEY	5211-49-0020	\$65.50
2842	73030	6.6	58	12.63		14 55% Cotton 28% Polyester17% Viscose	TURKEY	5211-49-0020	\$65.50
2842	73031	7.1	58		7	7 55% Cotton 27% Polyester18% Viscose	TURKEY	5211-49-0020	\$65.50
5018	73033	7.6	53.5		6	9 63% Cotton 19% Rayon 18%Linen	CHINA	5810.91.0010	\$73.50
3002	73034	9.5	53	11.5		7.25 68% Polyester 29% Linen 3% Rayon	CHINA	5810920000	\$82.50
3002	73035	9.5	53	11.38		7.25 68% Polyester 29% Linen 3% Rayon	CHINA	5810.92.9280	\$68.00
3022	73036	9.5	52	3.75		4.5 68% Polyester 29% Linen 3% Rayon	CHINA	5810920000	\$81.50
2798	77001	0.1	0.25		0	0 50% Cotton 50% Polyester	INDIA	5808.90.0010	\$10.50
2798	77002	0.1	0.25		0	0 85% Polyester 15% Jute	INDIA	5808.90.0010	\$14.50
2798	77003	0.1	0.25		0	0 70% Jute 30% Polyester	INDIA	5808.90.0010	\$14.50
2798	77004	0.1	0.25		0	0 35% Cotton 35% Polyester30% Jute	INDIA	5808.90.0010	\$14.50
2798	77005	0.1	0.75		0	0 60% Jute 40% Polyester	INDIA	5808.90.0010	\$15.50
2798	77006	0.1	0.75		0	0 100% Jute	INDIA	5808.90.0010	\$15.50
2798	77007	0.3	1.88		0	0 97% Glass 3% Nylon	INDIA	5808.90.0010	\$52.00
2798	77008	0.3	1.63		0	0 50% Acetate 25% Acrylic 25% Glass	INDIA	5808.90.0010	\$51.00
2798	77009	0.2	2		0	0 65% Coconut 25% Cotton 10% Wood	INDIA	5808.90.0010	\$71.00
2798	77010	0.3	1.88		0	0 65% Shell 25% Cotton 10%Glass	INDIA	5808.90.0010	\$71.00
2798	77011	0.2	2.13		0	0 90% Wood 10% Polyester	INDIA	5808.90.0010	\$71.00
2798	77012	0.3	2.75		0	0 75% Mother of Pearl 15% Bone 6% Wood4% Polyester	INDIA	5808.90.0010	\$71.00
2798	77013	0.1	1		0	0 100% Viscose	CHINA	5808.90.0010	\$17.50
2798	77014	0.1	1.75		0	0 100% Rayon	CHINA	5808.90.0010	\$19.50
2798	77015	0.4	2.25		0	0 100% Polyester	INDIA	5808.90.0010	\$38.50
2642	88307	0	54	27		27 100% Polyester	USA		\$50.00
2841	89188	3.8	54		0	0 100% Silk	INDIA	5007-20-0065	\$95.50
2895	89189	5.5	55		0	0 100% Silk	India	5007.20.65	\$127.00
2895	89190	5	55		0	0 65% Flax 35% Silk	India	5309.21.	\$116.00
2944	89191	9.5	54		0	0 95% Silk 5% Lurex	INDIA	5007.20.0095	\$155.00
2944	89192	12.4	54		0	0 100% Silk	INDIA	5007.20.0095	\$158.00
2944	89193	11.3	54		0	0 100% Silk	INDIA	5007.20.0095	\$148.00
2944	89194	14.7	54		0	0 60% Silk 40% Cotton	INDIA	5007.90.6090	\$84.00
2944	89195	15.3	54		0	0 68% Silk 32% Cotton	INDIA	5007.90.6090	\$84.00
2944	89196	13.3	54		0	0 68% Silk 32% Cotton	INDIA	5007.90.6090	\$78.50
2944	89197	9.5	54		0	0 100% Silk	INDIA	5007.20.0095	\$218.00
2944	89198	18.2	54		0	0 67% Cotton 33% Silk	INDIA	5212.22.6030	\$79.00
2944	89199	9.2	54		0	0 55% Silk 30% Viscose 15%Polyester	INDIA	5007.90.6090	\$107.50
2944	89201	8.7	54		0	0 55% Silk 35% Cotton 10% Polyester	INDIA	5007.20.0065	\$94.00
2944	89202	9.2	54		0	0 55% Silk 30% Viscose 15%Polyester	INDIA	5007.90.6090	\$112.50
2944	89203	15.6	54		0	0 100% Silk	INDIA	5007.20.0095	\$144.50
2944	89204	8.7	54		0	0 55% Silk 35% Cotton 10% Polyester	INDIA	5007.90.6090	\$94.00
2944	89205	23.9	54		0	0 100% Silk	INDIA	5007.20.0095	\$140.00
2944	89206	8.7	54		0	0 88% Silk 12% Viscose	INDIA	5007.20.0065	\$101.00
2944	89207	19	54		0	0 63% Silk 37% Viscose	INDIA	5007.90.6090	\$121.00
2944	89208	12.1	54		0	0 100% Silk	INDIA	5007.20.0095	\$151.00
2944	89209	12.4	54		0	0 55% Viscose 30% Silk 15%Polyester	INDIA	5516.91.0020	\$107.50
2944	89210	19.6	54		0	0 88% Silk 12% Viscose	INDIA	5007.20.0065	\$100.50
2944	89211	19	54		0	0 100% Silk	INDIA	5007.20.0095	\$218.00
2750	90836	17	54	4		3.38 38% Rayon 32% Polyester 30% Cotton	USA	5516.23.0090	\$115.00
2750	90837	17	54	13.5		13.5 38% Rayon 32% Polyester 30% Cotton	USA	5516-23-0090	\$112.00
2750	90839	12.1	54	1.25		2.25 54% Rayon 46% Polyester	USA	5516-23-0090	\$115.00
2750	90840	16.7	54	1.69		1.69 42% Cotton 32% Polyester26% Rayon	USA	5211-49-0020	\$115.00
2750	90844	11.6	54	13.63		13.5 52% Rayon 48% Polyester	USA	5516.23.0090	\$91.50
2750	90845	14.8	54	6		4.5 39% Acrylic 38% Polyester23% Rayon	USA	5515.21.0090	\$99.00
2749	90847	14.8	54	20.88		13.5 39% Acrylic 38% Polyester23% Rayon	USA	5515.21.0090	\$99.00

**Duralee
Retail Price List
(Limited Stock items excluded)**

Prices effective - July 1, 2016

Book	Pattern	Weight	Width	Vertical Repeat	Horizontal Repeat	Content	Origin	Tariff1	Retail
2750	90848	17.6	54	11.63		0 55% Cotton 23% Rayon 21%Polyester 1% Nylon	USA	5801-26-0010	\$74.50
2750	90849	20.8	54	0		0 51% Rayon 26% Cotton 21%Polyester 2% Nylon	USA	5516-43-0020	\$96.50
2750	90850	12.7	54	0		0 64% Post Ind RclD Polyester 20% Polyester16% Post Cons RclD Polyester	USA	5407-93-2090	\$76.00
2750	90852	13	54	1.88		0 62% Rayon 38% Polyester	USA	5516-23-0090	\$76.00
2750	90853	10.5	54	5		1.75 49% Polyester 25% Post Cons RclD Polyester26% Post Ind RclD Polyester	USA	5407.53.2060	\$95.50
2750	90854	9.3	54	13		6.75 56% Polyester 35% Post Ind RclD Polyester9% Post Cons RclD Polyester	USA	5407.53.2060	\$85.00
2800	90855	17.1	54	0		0 100% Polyester	USA	5903-90-2500	\$89.50
2800	90856	19.9	54	0		0 62% Polyester 38% Acrylic	USA	5903-90-2500	\$95.50
2800	90857	12.2	54	2		2.75 65% Polyester 35% Cotton	USA	5903-90-2500	\$101.50
2800	90858	12.1	54	3.38		1.75 65% Polyester 35% Rayon	USA	5903-90-2500	\$101.50
2800	90859	12.1	54	3.38		1.75 65% Polyester 35% Rayon	USA	5903-90-2500	\$101.50
2800	90860	14.9	54	3.38		2 64% Rayon 36% Polyester	USA	5903-90-2500	\$101.50
2800	90861	12.3	54	27		13.5 65% Polyester 35% Cotton	USA	5903-90-2500	\$101.50
2800	90863	13.2	54	0.63		0.63 53% Polyester 47% Rayon	USA	5903.90.3090	\$93.50
2800	90864	14.1	54	8.63		7.25 51% Acrylic 49% Polyester	USA	5903.90.3090	\$79.00
2800	90865	13.7	54	6.25		0 100% Polyester	USA	5903.90.3090	\$97.00
2800	90866	14.1	54	4		0 51% Acrylic 49% Polyester	USA	5903.90.3090	\$79.00
2800	90868	14.7	54	0.88		0 100% Polyester	USA	5515-12-0090	\$79.00
2800	90869	15.1	54.5	3.38	3.38	100% Polyester	USA	5515.12.0090	\$81.50
2800	90870	16.5	54	5.88		3 98% Polyester 2% Post Cons RclD Polyester	USA	5515-12-0090	\$81.50
2800	90871	15.5	54	2.5		0 92% Polyester 5% Post IndRclD Polyester3% Post Cons RclD Polyester	USA	5801-36-0010	\$81.50
2800	90872	15.1	55	7.5		7.5 69% Polyester 31% Post Cons RclD Polyester	USA	5407-93-2090	\$81.50
2800	90873	11.2	54	13.5		13.5 46% Polyester 39% Post Cons RclD Polyester15% Post Ind RclD Polyester	USA	5407.93.2090	\$105.00
2800	90874	12.2	54	2		2.75 65% Polyester 35% Cotton	USA	5903-90-2500	\$101.50
2849	90875	25.6	54	0		0 100% Polyester	INDIA	5801.36.0010	\$64.50
2848	90876	13.8	54	9		6.75 39% Polyester 31% Rayon 30% Cotton	USA	5903-90-2500	\$86.50
2847	90877	12.5	54	10		6.75 64% Polyester 36% Rayon	USA	5903-90-2500	\$85.00
2848	90878	11.9	54	10.13		13.5 65% Polyester 35% Rayon	USA	5903-90-2500	\$76.50
2848	90879	11.9	54	10.13		13.5 65% Polyester 35% Rayon	USA	5903-90-2500	\$78.50
2848	90880	9.9	54	10.75		13.5 100% Polyester	USA	5903-90-2500	\$73.50
2848	90881	13	54	14.5	14.38	71% Polyester 29% Rayon	USA	5407.93.2090	\$100.00
2848	90882	14.9	54	8		3.75 39% Acrylic 38% Polyester23% Rayon	USA	5515.21.0090	\$94.00
2848	90883	15.6	57.5	0.5		1.25 54% Polyester 46% Post Cons RclD Polyester	USA	5906-99-2500	\$80.50
2848	90884	15.6	57.5	7.25		3.75 54% Polyester 46% Post Cons RclD Polyester	USA	5906-99-2500	\$77.00
2848	90885	15	58.5	15.13		15 46% Post Cons RclD Polyester 26% Cotton26% Polyester 2% Post Ind RclD Polyester	USA	5906-99-2500	\$73.50
2848	90886	12	57.5	1.88		1.88 61% Rayon 39% Polyester	USA	5906-99-2500	\$64.50
2848	90887	14.6	58.5	3.25		3.75 100% Polyester	USA	5906-99-2500	\$77.00
2848	90888	14.3	59	2.25		7.5 100% Polyester	USA	5906-99-2500	\$77.00
2848	90889	15.2	59.5	8.25		7.5 67% Post Cons RclD Polyester 28% Polyester5% Post Ind RclD Polyester	USA	5906-99-2500	\$73.50
2848	90890	11.6	54	6.5		6.88 45% Polyester 40% Post Cons RclD Polyester15% Post Ind RclD Polyester	USA	5407.93.2090	\$87.50
2848	90891	11.3	54	4		6.88 70% Acetate 10% Post ConsRclD Polyester20% Post Ind RclD Polyester	USA	5407-53-2060	\$96.00
2848	90892	13	54	1.75		1.75 63% Cotton 37% Polyester	USA	5211-49-0020	\$84.90
2848	90893	14.8	54	6.5		4.5 55% Cotton 45% Polyester	USA	5211-49-0020	\$84.90
2848	90894	12.5	58	4.5		4.88 100% Polyester	USA	5407.53.2060	\$82.50
2848	90895	9.9	54	10.75		13.5 100% Polyester	USA	5903.90.2500	\$73.50
2848	90896	13.9	54	2.75		2.75 61% Rayon 39% Polyester	USA	5903.90.2500	\$83.50
2866	90898	13.3	54	0		0 100% Polyester	CHINA	5801.36.00.10	\$43.50
2866	90899	11.3	54	0		0 100% Polyester	CHINA	5407.61.99.45	\$50.00
2866	90901	20.9	56	0		0 80% Polyester 20% Rayon	CHINA	5407.92.2090	\$46.50
2903	90902	14.8	54	11		4.75 63% Acrylic 37% Polyester	USA	5515.21.0090	\$71.50
2903	90903	14.5	54	14.5	14.13	61% Polyester 39% Acrylic	USA	5515.21.0090	\$85.50
2903	90904	11.9	54	3.5		0 39% Acrylic 61% Polyester	USA	5407.93.2090	\$65.00
2903	90905	11.6	54	3.5		0 52% Acrylic 48% Polyester	USA	5512.21.0090	\$62.50
2903	90906	11.2	54	1.63		1.75 58% Polyester 42% Acrylic	USA	5407.93.2090	\$60.50
2903	90907	11.9	54	5.75		0.63 47% Polyester 36% Acrylic17% Rayon	USA	5407.93.2090	\$65.00
2903	90908	9.8	54	7.25		4.75 57% Polyester 43% Rayon	USA	5407.93.2090	\$74.50
2903	90909	12.7	58.5	2.75		3.75 46% Cotton 37% Polyester15% Rayon2% Metallic	USA	5903.90.2500	\$64.00
2903	90910	10.4	59	3.63		3.75 100% Polyester	USA	5903.90.2500	\$52.00

Duralee
Retail Price List
(Limited Stock items excluded)

Prices effective - July 1, 2016

Book	Pattern	Weight	Width	Vertical	Horizontal	Content	Origin	Tariff1	Retail
				Repeat	Repeat				
2903	90911	15.2	57.5	1.38	0.63	68% Polyester 32% Rayon	USA	5801.36.0010	\$61.50
2903	90912	10.7	59	0.63	0.5	45% Polyester 36% Post Ind Rclid Polyester19% Post Cons Rclid Polyester	USA	5906.99.2500	\$61.50
2903	90913	14	59	16.88	30	88% Polyester 8% Post IndRclid Polyester4% Post Cons Rclid Polyester	USA	5407.93.2090	\$80.50
2903	90914	13.7	59	8.25	0.25	54% Cotton 46% Polyester	USA	5211.49.0020	\$52.00
2903	90915	106.3	54	9.5	14.25	55% Post Cons Rclid Polyester 45% Polyester	USA	5515.12.0090	\$84.50
2903	90916	9.2	54	5	4.75	57% Polyester 28% Post Ind Rclid Polyester15% Post Cons Rclid Polyester	USA	5407.53.2060	\$73.50
2903	90917	11.5	54	2	3.5	100% Polyester	USA	5407.53.2060	\$83.50
2933	90918	27.6	54	0	0	100% Polyester	CHINA	5903.90.3030	\$81.50
2933	90919	24	54	0	0	100% Polyester	CHINA	5903.90.3030	\$72.00
2933	90920	14.7	54	10	7.25	53% Acrylic 47% Polyester	USA	5903.90.3090	\$85.00
2933	90921	14.7	54	5.38	4.88	53% Acrylic 47% Polyester	USA	5903.90.3090	\$85.00
2933	90922	16	55	0.38	0.38	41% Polyester 38% Post Ind Rclid Polyester21% Post Cons Rclid Polyester	USA	5903.90.2500	\$81.00
2933	90924	15.9	54.75	15	7.25	100% Polyester	USA	5903.90.2500	\$99.50
2933	90925	16.8	55	20.25	15.5	45% Post Cons Rclid Polyester 40% Polyester15% Post Ind Rclid Polyester	USA	5903.90.2500	\$98.50
2933	90926	12.7	55	5	7.5	100% Polyester	USA	5903.90.2500	\$87.00
2933	90928	9.8	54	2.63	2.88	55% Polyester 30% Post Ind Rclid Polyester15% Post Cons Rclid Polyester	USA	5407.53.2060	\$97.50
2933	90929	9.9	54	6.63	7	71% Polyester 29% Post Cons Rclid Polyester	USA	5407.93.2090	\$102.50
2933	90930	10.5	54	11.13	14.25	49% Polyester 18% Post Cons Rclid Polyester33% Post Ind Rclid Polyester	USA	5407.53.2060	\$102.50
2933	90931	9.8	54	19	14.25	53% Polyester 30% Post Ind Rclid Polyester17% Post Cons Rclid Polyester	USA	5407.53.2060	\$99.00
2959	90932	14.5	54	0	0	100% Polyester	CHINA	5407529000	\$44.00
2959	90933	11.4	54	2	0.63	77% Polyester 23% Acrylic	USA	5407939000	\$72.00
2959	90934	10.9	54	16.5	14.5	100% Polyester	USA	5407939000	\$72.00
2959	90935	15.7	54	14.63	14.38	55% Acrylic 37% Polyester8% Rayon	USA	5515219000	\$94.50
2959	90936	20.5	57.5	0	0	49% Polyester 29% Post Cons Rclid Polyester21% Post Ind Rclid Polyester 1% Nylon	USA	5903902900	\$77.00
2959	90937	18.6	56.5	0	0	100% Polyester	USA	5903902900	\$65.00
2959	90938	18.1	57.5	0	7.5	61% Polyester 25% Post Ind Rclid Polyester14% Post Cons Rclid Polyester	USA	5903902900	\$65.00
2959	90939	14.7	58	0.13	0.25	73% Polyester 27% Olefin	USA	5903902900	\$59.00
2959	90940	16.8	59.5	17.63	15	100% Polyester	USA	5515129000	\$77.50
2959	90941	13.8	58.5	4	1	46% Polyester 35% Post Ind Rclid Polyester19% Post Cons Rclid Polyester	USA	5903902900	\$62.50
2959	90942	13.5	59	6.13	2.5	49% Polyester 33% Post Ind Rclid Polyester18% Post Cons Rclid Polyester	USA	5903902900	\$62.50
2959	90943	12	58.5	3.75	3.63	96% Polyester 1% Post Cons Rclid Polyester3% Post Ind Rclid Polyester	USA	5515129000	\$65.00
2959	90944	11.3	54	14.5	13.5	46% Polyester 35% Post Ind Rclid Polyester19% Post Cons Rclid Polyester	USA	5407530029	\$88.50
2958	90945	11.3	54	14.5	13.5	46% Polyester 35% Post Ind Rclid Polyester19% Post Cons Rclid Polyester	USA	5407530029	\$88.50
2960	90946	20	54	0	0	60% Polyester 40% Polyurethane	CHINA	5903202500	\$72.00
2960	90947	20	54	0	0	60% Polyester 40% Polyurethane	CHINA	5903202500	\$72.00
2960	90948	20	54	0	0	60% Polyester 40% Polyurethane	CHINA	5903202500	\$72.00
2960	90949	20	54	0	0	60% Polyester 40% Polyurethane	CHINA	5903202500	\$72.00
2960	90950	20	54	0	0	60% Polyester 40% Polyurethane	CHINA	5903202500	\$72.00
2960	90951	20	54	0	0	60% Polyester 40% Polyurethane	CHINA	5903202500	\$72.00
3007	90952	22	54	0	0	100% Polyester	CHINA	5903.90.3030	\$91.50
3007	90953	22.7	54	0	0	100% Polyester	CHINA	5903.90.3030	\$91.50
3007	90954	15.1	54	0	0	75% Polyester 20% Rayon 5% Metallic	USA	5903.90.3090	\$105.00
3007	90955	15.4	55	0.5	0.38	100% Polyester	USA	5903.90.2500	\$86.50
3007	90956	17.9	54.5	7.13	3.5	79% Polyester 14% Post Ind Rclid Polyester7% Post Cons Rclid Polyester	USA	5903.90.2500	\$99.00
3007	90957	15.9	56.5	7	3.63	100% Polyester	USA	5903.90.2500	\$99.00
3007	90958	16	56.5	1.88	0	88% Polyester 8% Post IndRclid Polyester4% Post Cons Rclid Polyester	USA	5903.90.2500	\$93.00
3007	90959	16	55.5	3.75	3.63	100% Polyester	USA	5903.90.2500	\$98.00
3007	90960	20.3	56	8	7.5	100% Polyester	USA	5903.90.2500	\$99.00
3007	90961	19.4	56	0	0	89% Polyester 7% Post IndRclid Polyester4% Post Cons Rclid Polyester	USA	5903.90.2500	\$93.00
3007	90962	22.4	55	0	0	100% Polyester	USA	5903.90.2500	\$74.50
3007	90963	11.2	56.5	7.5	7	46% Polyester 35% Post Ind Rclid Polyester19% Post Cons Rclid Polyester	USA	5407.53.2060	\$109.00
3006	90964	11.2	56.5	7.5	7	46% Polyester 35% Post Ind Rclid Polyester19% Post Cons Rclid Polyester	USA	5407.53.2060	\$109.00
2675	92510	0	54	25.2	13.4	50% Polyester FR 50% Polyester	USA		\$100.00

US Price List 2016

Prices are FOB Yaphank, NY and are subject to change without notice.
Maharam reserves the right to discontinue any pattern or color at any time.

For comprehensive product, information visit maharam.com or call 800.645.3943.

US Price List 2016

PATTERN AND STYLE NUMBER	PRIMARY APPLICATION	WIDTH	PER SQ FT	PER YD
(Clock/Pizza - Turquoise) by John Baldessari 399733	Walls	27"	22.22	150.00
(Ear/Pretzel - Pink) by John Baldessari 399735	Walls	27"	22.22	150.00
(Nose/Popcorn - Yellow/Green) by John Baldessari 399737	Walls	27"	22.22	150.00
(Potato/Lightbulb - Blue) by John Baldessari 399739	Walls	27"	22.22	150.00
A Band Apart by Sarah Morris 466000	Seating	56"		198.00
Abacus 466118	Seating	54"		49.00
Abacus Standard 466140	Seating	54"		32.50
Acqua e Fuoco by Gio Ponti, 1933 282980	Residential Windows	54"		155.00
Acre 466106	Seating	54"		43.00
Across 465964	Seating	54"		51.00
Adjourn 511350	Privacy Curtain	72"		38.00
Aftermath by Studio Job 466169	Seating	55"		190.00
Agency by Sarah Morris 466001	Seating	55"		198.00
Air by Kvadrat 281830	Windows	118"		42.00
Akimbo 464770	Seating	54"		50.00
Align 464080	Seating	54"		45.00
Alloy 466064	Seating	54"		41.00
Alpaca Epingle 465902	Seating	55"		175.00
Alpaca Herringbone 465898	Seating	56"		132.00
Alpaca Velvet 465901	Seating	54"		175.00
Alter 464880	Seating	59"		39.00
Anagram 466067	Seating	54"		64.00
Antidote by Raqs Media Collective 399948	Walls	27"		150.00
Aqua by Kvadrat 281960	Windows	59"		50.00
Arabesque by Alexander Girard®, 1954 466204	Seating	53"		98.00
Argali by Danskina 5' 11" x 7' 10" 650016	Floors			3,500.00
Argali by Danskina 6' 7" x 9' 10" 650017	Floors			4,800.00
Argali by Danskina 9' 10" x 13' 1" 650018	Floors			9,000.00
Argyle 399640	Walls	52"	1.88	24.50 ≧
Aria 459950	Residential Seating	55"		98.00
Array 466300	Seating	54"		42.00
Article 458600	Seating	54"		29.00
Assembled Check by Paul Smith 466345	Seating	55"		210.00
Assembly 399425	Walls	54"	1.44	19.50 ≧
Balustrade 463120	Seating	54"		57.50
Banded Stripe by Paul Smith 399654	Walls	54"	2.15	29.00 ≧
Banister 466263	Seating	54"		52.00
Bar 466227	Seating	59"		32.00
Bar Crypton 466234	Seating	54"		45.00
Basel by Kvadrat 466214	Seating	55"		45.00
Basket 399412 **	Walls	36"	5.56	50.00 ≧
Batiste 283766	Windows	116"		58.00

≧On quantities less than bolt size, a US \$3.00 per yard cutting charge will apply.

* Available in multiples of 1 panel only.

** Available in multiples of 4 yards only.

† Available in bolt/30 yard increments.

‡ Available in 2.1 yard increments.

US Price List 2016

PATTERN AND STYLE NUMBER	PRIMARY APPLICATION	WIDTH	PER SQ FT	PER YD
Bavaria by Studio Job 466162	Seating	55"		265.00
Bavaria Stripe by Studio Job 466161	Seating	55"		160.00
Bead 511481	Privacy Curtain	72"		36.00
Beam 466119	Seating	54"		53.00
Before 464630	Seating	58"		37.50
Beside 464020	Seating	54"		47.50
Bespoke Stripe by Paul Smith 463540	Seating	56"		135.00
Bevel 466131	Seating	54"		34.00
Big Stripe by Paul Smith 466174	Seating	55"		160.00
Bitmap 466066	Seating	54"		36.50
Blip 466129	Seating	54"		54.00
Blocks by Scholten & Baijings 466209	Seating	56"		175.00
Blumen by Dagobert Peche, 1913 462870	Seating	55"		98.00
Bold by Danskina 650003	Floors		65.00	
Borders by Hella Jongerius 466082	Residential Seating	53"		260.00
Boucle Leno 283280	Residential Windows	52"		60.00
Bound 465320	Seating	58"		39.00
Boundary 466193	Seating	54"		39.00
Branch 511472	Privacy Curtain	72"		35.00
Bridge 465908	Seating	59"		39.00
Bright Angle by Scholten & Baijings 466331	Seating	54"		75.00
Bright Cube by Scholten & Baijings 466329	Seating	54"		75.00
Bright Grid by Scholten & Baijings 466330	Seating	54"		75.00
Brim 466350	Seating	54"		59.00
Brushed Camel 465977	Residential Seating	58"		240.00
Brushed Cashmere 465978	Residential Seating	54"		475.00
Brushed Merino 465983	Residential Seating	54"		210.00
Buckram 283770	Windows	116"		55.00
Buoyant 511280	Privacy Curtain	72"		38.00
Campas by Kvadrat 281620	Windows	55"		47.00
Campus 399579	Walls	54"	1.19	16.00 =>
Candid 463720	Seating	54"		33.00
Canvas by Kvadrat 466185	Seating	55"		48.00
Carapace by Hella Jongerius 466261	Seating	54"		92.00
Carry 511466	Privacy Curtain	72"		37.00
Cartouche 465988	Seating	54"		49.50
Casa by Kvadrat 283751	Windows	118"		80.00
Cashmere Ripple 465979	Residential Seating	58"		575.00
Castillo by Kvadrat 283752	Windows	118"		80.00
Catch 399560	Walls	36"	4.11	37.00 =>
Centric 466056	Seating	54"		67.00
Certain 465949	Seating	54"		49.00

=>On quantities less than bolt size, a US \$3.00 per yard cutting charge will apply.

* Available in multiples of 1 panel only.

** Available in multiples of 4 yards only.

† Available in bolt/30 yard increments.

‡ Available in 2.1 yard increments.

US Price List 2016

PATTERN AND STYLE NUMBER	PRIMARY APPLICATION	WIDTH	PER SQ FT	PER YD
Chalet 466324	Outdoor Seating	54"		52.00
Chalk 399616	Walls	54"	7.11	96.00 ‡
Chambray 397140	Walls	54"	1.19	16.00 ‡
Chance 464010	Seating	54"		50.50
Chart 399633	Walls	54"	1.33	18.00 ‡
Checker by Alexander Girard®, 1965 459830	Seating	55"		105.00
Checker Split by Alexander Girard®, 1965 460290	Seating	55"		105.00
Chenille Cord 407808	Seating	54"		66.00
Chenille Stripe by Anni Albers, 1946 459820	Seating	54"		110.00
Chime 465350	Seating	54"		35.50
Chisel 399571	Walls	54"	1.56	21.00 ‡
Chock 466219	Seating	59"		44.00
Chroma by Hella Jongerius 466303	Seating	54"		250.00
Cinch 466002	Seating	54"		32.00
Cipher 463010	Seating	54"		66.00
Circle Cutter's Room by Rosemarie Trockel 399755	Walls	27"	22.22	150.00
Circles by Charles and Ray Eames, 1947 458310	Seating	55"		98.00
Circuit 466089	Seating	54"		42.50
Climb 465922	Seating	54"		71.00
Cloak 399561 **	Walls	36"	4.00	36.00 ‡
Coach Cloth 458950	Seating	54"		112.00
Cobble 395540	Walls	52"	2.12	27.50 ‡
Cobblestone 465250	Seating	55"		118.00
Coda by Kvadrat 464480	Seating	55"		88.00
Coin 466233	Seating	57"		32.00
Coin Crypton 466236	Seating	54"		45.00
Coincide 465808	Seating	54"		30.50
Coincide High Performance 466132	Seating	54"		45.00
Colline by Kvadrat 466155	Seating	55"		52.00
Colorfield by Hella Jongerius 466315	Seating	54"		210.00
Colorwheel by Hella Jongerius 466163	Seating	54"		74.00
Column 466192	Seating	54"		50.00
Comb 399689	Walls	54"	1.56	21.00 ‡
Commentary 466109	Seating	54"		46.00
Compartment 466154	Seating	50"		192.00
Compound 466196	Seating	54"		48.00
Confetti by Hella Jongerius 466203	Seating	54"		89.00
Convène 511494	Privacy Curtain	72"		36.00
Cork & Felt by Danskina 650006	Floors		110.00	
Cornice 511469	Privacy Curtain	72"		35.00
Cotton Velvet 466199	Residential Seating	55"		117.00
Couple 466010	Seating	54"		52.50

‡ On quantities less than bolt size, a US \$3.00 per yard cutting charge will apply.

* Available in multiples of 1 panel only.

** Available in multiples of 4 yards only.

† Available in bolt/30 yard increments.

‡ Available in 2.1 yard increments.

US Price List 2016

PATTERN AND STYLE NUMBER	PRIMARY APPLICATION	WIDTH	PER SQ FT	PER YD
Course 399443	Walls	52"	1.77	23.00 ‡
Cover 465800	Seating	54"		37.00
Crate 399757	Walls	36"	3.55	32.00 ‡
Crew 466149	Seating	54"		52.00
Crisp 901420	Systems & Upholstered Walls	66"		24.50
Cross Cut by Danskina 650024	Floors		65.00	
Crosspatch by Charles and Ray Eames, 1947 458920	Seating	54"		98.00
Crush 464780	Seating	54"		49.00
Cubist 511482	Privacy Curtain	72"		35.00
Cue 399634	Walls	54"	1.33	18.00 ‡
Cursive 466335	Seating	54"		60.00
Cycle 466275	Seating	54"		37.00
Dapper 466316	Seating	54"		38.00
Dart 464040	Seating	54"		52.00
Dash 462720	Seating	58"		41.00
Daze 281260	Residential Windows	59"		85.00
Debut 399678	Walls	32"	9.37	75.00 ‡
Deck 399702	Walls	36"	3.55	32.00 ‡
Decode 464800	Seating	54"		49.50
Deconstructed Rose 466086	Seating	55"		188.00
Defer 464250	Seating	58"		35.00
Design 9297 by Josef Hoffmann, 1913 465230	Seating	55"		102.00
Dew by Danskina 650019	Floors		80.00	
Dice by Paul Smith 399816	Walls	27"	18.52	125.00
Dingbats 465994	Seating	54"		90.00
Disc 466221	Seating	57"		34.00
Disc Crypton 466237	Seating	54"		46.00
Disperse 466017	Seating	53"		46.00
Ditto 465993	Seating	54"		54.00
Divide 466220	Seating	57"		34.00
Divide Crypton 466238	Seating	54"		46.00
Divina by Kvadrat 460730	Seating	59"		59.00
Divina MD by Kvadrat 466150	Seating	59"		59.00
Divina Melange by Kvadrat 460830	Seating	59"		59.00
Division 464540	Seating	58"		34.50
Dominoes by Paul Smith 399817	Walls	27"	18.52	125.00
Dot Pattern by Charles and Ray Eames, 1947 458300	Seating	55"		98.00
Dot Pattern Sheer Negative by Charles and Ray Eames, 1947 281660	Residential Windows	59"		130.00
Dot Pattern Sheer Positive by Charles and Ray Eames, 1947 281650	Windows	59"		130.00
Double Triangles by Alexander Girard®, 1952 459840	Seating	55"		105.00

‡ On quantities less than bolt size, a US \$3.00 per yard cutting charge will apply.

* Available in multiples of 1 panel only.

** Available in multiples of 4 yards only.

† Available in bolt/30 yard increments.

‡ Available in 2.1 yard increments.

US Price List 2016

PATTERN AND STYLE NUMBER	PRIMARY APPLICATION	WIDTH	PER SQ FT	PER YD
Drape by Konstantin Grcic 466145	Seating	54"		52.00
Drenth Heath 800730	Accessories			4,750.00
Drenth Heath Pelt 800880	Accessories			1,100.00
Dual 398630	Walls	54"	2.30	31.00 ‡
Dune 399564	Walls	36"	3.11	28.00 ‡
Dune by Danskina 200130	Floors		85.00	
Duotone by Danskina 650004	Floors		50.00	
East by Danskina 200240	Floors		70.00	
Eden by Hella Jongerius 466258	Seating	56"		182.00
Effect 398550	Walls	54"	1.85	25.00 ‡
Ellipsis 466334	Seating	54"		47.00
Emblem 466205	Seating	54"		48.00
Emboss by Konstantin Grcic 466281	Seating	54"		53.00
Emerge 511493	Privacy Curtain	72"		36.00
Enmesh 466338	Seating	54"		39.00
Eno by Danskina 200220	Floors		110.00	
Epingle Stripe by Paul Smith 466007	Seating	50"		153.00
Equinox 511468	Privacy Curtain	72"		36.00
Exaggerated Plaid by Paul Smith 466039	Seating	59"		120.00
Exchange 466027	Seating	57"		37.50
Facets by Alexander Girard®, 1952 459850	Seating	55"		105.00
Fasten 466053	Seating	54"		55.50
Fathom 466013	Seating	54"		32.50
Feature 466343	Seating	54"		46.00
Felicia by Kvadrat 281900	Windows	55"		42.00
Feltro Due by Paola Lenti 650014	Floors		95.00	
Feltro Tre by Paola Lenti 650012	Floors		110.00	
Feltro Uno by Paola Lenti 650013	Floors		110.00	
Fiddle 466016	Seating	54"		56.50
Field 901170	Systems & Upholstered Walls	66"		29.00
File 399628	Walls	52"	1.73	22.50 ‡
Fillippa by Kvadrat 283733	Windows	55"		42.00
Finger by Ai Weiwei 399724	Walls	27"	22.22	150.00
Fishbone 399622	Walls	54"	1.33	18.00 ‡
Fix 399441	Walls	52"	1.77	23.00 ‡
Flaxen 397130	Walls	54"	1.19	16.00 ‡
Float 283674	Windows	130"		100.00
Flock 901892	Upholstered Walls	63"		28.00
Florentijn by Kvadrat 283732	Windows	52"		42.00
Floret 464070	Seating	54"		51.50
Flourish 511458	Privacy Curtain	72"		44.00
Fluctuation 283330	Residential Windows	45"		52.00

‡ On quantities less than bolt size, a US \$3.00 per yard cutting charge will apply.

* Available in multiples of 1 panel only.

** Available in multiples of 4 yards only.

† Available in bolt/30 yard increments.

‡ Available in 2.1 yard increments.

US Price List 2016

PATTERN AND STYLE NUMBER	PRIMARY APPLICATION	WIDTH	PER SQ FT	PER YD
Fluent Crypton 466073	Seating	54"		50.00
Flute 399762	Walls	43"	11.16	120.00
Fluted Silk 465982	Residential Seating	54"		95.00
Focus 465910	Seating	57"		32.00
Fold by Konstantin Grcic 466292	Seating	54"		53.00
Foliage by Hella Jongerius 466257	Seating	56"		182.00
Fraction 466137	Seating	54"		52.00
Fringe by Danskina 650015	Floors		50.00	
Frost by Kvadrat 283760	Windows	118"		28.00
Fruit by Hella Jongerius 466262	Seating	54"		90.00
Fruit Tree by Alexander Girard®, 1961 399770	Walls	52"	2.23	29.00 ≍
Garden by Hella Jongerius 466134	Seating	54"		74.00
Gauge 901877	Systems & Upholstered Walls	66"		29.00
Gentle 399340 **	Walls	36"	4.67	42.00 ≍
Geometri by Verner Panton, 1960 459970	Seating	55"		105.00
Geometri Sheer by Verner Panton, 1960 281630	Residential Windows	59"		130.00
Ginger by Kvadrat 283580	Windows	118"		88.00
Glance 901891	Systems & Upholstered Walls	54"		28.00
Glint 901380	Upholstered Walls	54"		31.00
Gloss 399617	Walls	54"	5.04	68.00 ≍
Golden Age by Ai Weiwei 399726	Walls	27"	22.22	150.00
Grade 466260	Seating	55"		59.00
Gradient Dot by Paul Smith 399655	Walls	54"	2.15	29.00 ≍
Gradient Stripe by Paul Smith 399651	Walls	54"	2.15	29.00 ≍
Grano by Danskina 200060	Floors		75.00	
Grid by Scholten & Baijings 466210	Seating	56"		175.00
Guise 399569	Walls	54"	1.48	20.00 ≍
Hallingdal by Kvadrat 460760	Seating	51"		67.00
Hedge 466298	Seating	54"		48.00
Helix 466271	Seating	54"		64.00
Hem 511483	Privacy Curtain	72"		47.00
Hero by Kvadrat 466318	Seating	55"		47.00
Herring 399614	Walls	54"	8.15	110.00 ≍
Herringbone Stripe by Paul Smith 465945	Seating	57"		135.00
Highfield by Kvadrat 465957	Seating	55"		70.00
Honor Weave 395510	Walls	52"	1.92	25.00 ≍
Horsehair Basket 465981	Residential Seating	26"		430.00
Horsehair Check 465980	Residential Seating	22"		475.00
Horsehair Striae 465984	Residential Seating	26"		370.00
Houndstooth by Paul Smith 466253	Seating	54"		90.00
Hours by Hella Jongerius 466092	Seating	56"		290.00
Hum 901890	Systems & Upholstered Walls	54"		36.00

≍ On quantities less than bolt size, a US \$3.00 per yard cutting charge will apply.

* Available in multiples of 1 panel only.

** Available in multiples of 4 yards only.

† Available in bolt/30 yard increments.

‡ Available in 2.1 yard increments.

US Price List 2016

PATTERN AND STYLE NUMBER	PRIMARY APPLICATION	WIDTH	PER SQ FT	PER YD
I Morosi alla Finestra by Gio Ponti, 1930 281710	Residential Windows	54"		155.00
Increment 511443	Privacy Curtain	72"		44.00
Indent 399100	Walls	52"	2.15	28.00 ≈
Indo 399555	Walls	52"	1.73	22.50 ≈
Industry by Studio Job 466255	Seating	55"		195.00
Ingrain 398590 **	Walls	36"	4.33	39.00 ≈
Illude 399912	Walls	54"		27.00 ≈
Insignia 466308	Seating	54"		58.00
Jacobs Coat by Alexander Girard®, 1959 462270	Seating	54"		128.00
Jaunt 2 511475	Privacy Curtain	72"		32.00
Join 283040	Windows	118"		60.00
Kindred 466166	Seating	54"		47.00
Knob 466250	Seating	54"		160.00
Knot 466248	Seating	56"		94.00
Lanalux by Alexander Girard®, 1970 466240	Residential Seating	54"		300.00
Lantern 399897	Walls	43"		130.00 ≈
Lariat 440401	Seating	54"		34.50
Latch 466301	Seating	55"		61.00
Laurel 511473	Privacy Curtain	72"		35.00
Layers Garden by Hella Jongerius 465916	Seating	52"		155.00
Layers Garden Double by Hella Jongerius 465917	Seating	52"		300.00
Layers Park by Hella Jongerius 465918	Seating	52"		155.00
Layers Park Double by Hella Jongerius 465919	Seating	52"		300.00
Layers Vineyard Large by Hella Jongerius 465921	Seating	52"		155.00
Layers Vineyard Small by Hella Jongerius 465920	Seating	52"		155.00
Leaf 399620	Walls	36"	3.89	35.00 ≈
Leaflet Plaid 502408	Privacy Curtain	72"		44.00
Ledger 463770	Seating	54"		36.00
Lens 466323	Seating	54"		39.00
Letters by Gunnar Aagaard Andersen, 1955 462560	Seating	55"		110.00
Lift by Konstantin Grcic 466302	Seating	54"		65.00
Lineage 466127	Seating	54"		32.50
Link 466328	Outdoor Seating	54"		59.00
Linomix by Alexander Girard®, 1957 466239	Seating	50"		185.00
Lucid 399632	Walls	54"	1.33	18.00 ≈
Lucky by Danskina 200230	Floors		95.00	
Lumina by Danskina 200090	Floors		95.00	
Luminous 397000	Walls	54"	1.44	19.50 ≈
Lux by Kvadrat 283753	Windows	130"		46.00
Manner 466177	Seating	54"		25.50
Mark by Kvadrat 283748	Windows	63"		46.00
Marquee 463890	Seating	54"		30.00

≈ On quantities less than bolt size, a US \$3.00 per yard cutting charge will apply.

* Available in multiples of 1 panel only.

** Available in multiples of 4 yards only.

† Available in bolt/30 yard increments.

‡ Available in 2.1 yard increments.

US Price List 2016

PATTERN AND STYLE NUMBER	PRIMARY APPLICATION	WIDTH	PER SQ FT	PER YD
Massive Paisley 465915	Seating	57"		178.00
Matrix by Kvadrat 466212	Seating	55"		72.00
Meander 466050	Seating	54"		51.00
Mechanism 465952	Seating	54"		74.00
Medium 463490	Seating	54"		28.00
Melange Tweed 461190	Seating	54"		112.00
Memory by Kvadrat 466211	Seating	59"		59.00
Mention 398580 **	Walls	36"	4.44	40.00 ≍
Meridian 464710	Seating	54"		43.00
Messenger 458640	Seating	54"		26.00
Metric 466014	Seating	54"		26.50
Micro 466099	Seating	54"		33.00
Mikado by Alexander Girard®, 1954 459330	Seating	54"		98.00
Milestone 403901	Seating	54"		25.50
Millerstripe by Alexander Girard®, 1973 462250	Seating	54"		128.00
Mimic 466136	Outdoor Seating	54"		63.00
Mineral 466232	Seating	54"		43.00
Minicheck by Alexander Girard®, 1952 466268	Seating	56"		105.00
Minimal 466026	Seating	54"		49.50
Minute 399782	Walls	54"	1.33	18.00 ≍
Mirage 399563	Walls	36"	4.44	40.00 ≍
Missing Thread by Kvadrat 283680	Windows	118"		60.00
Mister 466178	Outdoor Seating	54"		56.00
Mixed Stripe by Paul Smith 399652	Walls	54"	2.15	29.00 ≍
Mode 466337	Seating	54"		28.00
Moderate 511459	Privacy Curtain	72"		43.00
Mohair Extreme 464820	Seating	55"		200.00
Mohair Supreme 451801	Seating	54"		138.00
Monk's Wool 457301	Seating	54"		135.00
Morse 901720	Systems & Upholstered Walls	66"		26.00
Mortise 466213	Seating	54"		47.00
Multi Stripe by Paul Smith 399800	Walls	54"	2.15	29.00 ≍
Multitone by Danskina 4'3" x 5'7" 650007	Floors			1,300.00
Multitone by Danskina 6' 7" x 9'10" 650008	Floors			3,200.00
Names by Alexander Girard®, 1957 462510	Seating	55"		105.00
Nano Point 901410	Systems & Upholstered Walls	66"		34.00
Nectar by Kvadrat 283360	Windows	59"		88.00
Net 399630	Walls	54"	1.33	18.00 ≍
Nexus 399898	Walls	54"		100.00 ≍
Noble 399394 **	Walls	36"	6.89	62.00 ≍
Nook 399913	Walls	54"		27.00 ≍
Noon by Kvadrat 283761	Windows	118"		32.00

≍ On quantities less than bolt size, a US \$3.00 per yard cutting charge will apply.

* Available in multiples of 1 panel only.

** Available in multiples of 4 yards only.

† Available in bolt/30 yard increments.

‡ Available in 2.1 yard increments.

US Price List 2016

PATTERN AND STYLE NUMBER	PRIMARY APPLICATION	WIDTH	PER SQ FT	PER YD
Notch 399615	Walls	54"	6.96	94.00 ☞
Oblique 466222	Seating	58"		30.00
Octave 466116	Outdoor Seating	54"		57.00
Oculus 283776	Windows	121"		75.00
Offset 465951	Seating	54"		66.50
Oh 511478	Privacy Curtain	72"		35.00
Omen 466172	Seating	54"		52.50
Open 398610 **	Walls	36"	5.78	52.00 ☞
Optik by Verner Panton, 1969 459960	Seating	55"		105.00
Orakelblume by Koloman Moser, 1901 463900	Seating	55"		102.00
Ottoman Stripe by Paul Smith 466142	Seating	58"		135.00
Outback by Kvadrat 466061	Seating	55"		66.00
Outline 397420	Walls	54"	1.85	25.00 ☞
Painted Stripe 465998	Seating	55"		110.00
Palio by Alexander Girard®, 1964 466107	Seating	55"		90.00
Parallel 901180	Systems & Upholstered Walls	66"		28.00
Parched Silk 465974	Residential Seating	55"		110.00
Park by Hella Jongerius 466135	Seating	54"		74.00
Pavement by George Nelson, 1950 459740	Seating	54"		98.00
Paver 466111	Outdoor Seating	54"		53.50
Pavilion by Marc Camille Chaimowicz 399722	Walls	27"	22.22	150.00
Peak 399779	Walls	54"	1.33	18.00 ☞
Pebble Wool 457401	Seating	54"		136.00
Pebble Wool Multi 461200	Seating	54"		136.00
Peer 511463	Privacy Curtain	72"		35.00
Pennant 466094	Seating	58"		51.50
Periphery 465900	Seating	56"		104.00
Phase 281200	Windows	118"		39.00
Pick 466224	Seating	58"		30.00
Pick Crypton 466235	Seating	54"		43.00
Pin 399602	Walls	54"	1.41	19.00 ☞
Pitch 466186	Outdoor Seating	54"		37.00
Pixel 399604	Walls	52"	2.12	27.50 ☞
Plait 466052	Seating	58"		37.50
Plait High Performance 466138	Seating	54"		44.50
Playing Cards Back by Paul Smith 399815	Walls	27"	18.52	125.00
Playing Cards Front by Paul Smith 399814	Walls	27"	18.52	125.00
Pleat 395550	Walls	52"	1.88	24.50 ☞
Plot 399605	Walls	54"	1.56	21.00 ☞
Plural 463630	Seating	56"		98.00
Ply Mesh Black/Tan 465020	Seating	53"		110.00
Pocket 466243	Seating	54"		50.50

☞ On quantities less than bolt size, a US \$3.00 per yard cutting charge will apply.

* Available in multiples of 1 panel only.

** Available in multiples of 4 yards only.

† Available in bolt/30 yard increments.

‡ Available in 2.1 yard increments.

US Price List 2016

PATTERN AND STYLE NUMBER	PRIMARY APPLICATION	WIDTH	PER SQ FT	PER YD
Point by Paul Smith 466090	Seating	53"		120.00
Poise 399395 **	Walls	36"	5.67	51.00 ≈
Polished 398350	Walls	54"	1.19	16.00 ≈
Posy 2 511476	Privacy Curtain	72"		32.00
Prairie 399413 **	Walls	36"	4.78	43.00 ≈
Pressed Plaid 466181	Seating	54"		136.00
Progression 2 511477	Privacy Curtain	72"		32.00
Quatrefoil by Alexander Girard®, 1954 459340	Seating	54"		98.00
Quick 465850	Seating	54"		33.00
Radiant 462500	Seating	54"		80.00
Raffia 399619	Walls	36"	4.67	42.00 ≈
Range 399543	Walls	54"	1.19	16.00 ≈
Recollection 465968	Seating	54"		46.50
Reef by Hella Jongerius 466332	Seating	54"		85.00
Reel 466065	Seating	53"		63.00
Refine 398570 **	Walls	36"	4.56	41.00 ≈
Regatta 466189	Outdoor Seating	54"		57.00
Remix by Kvadrat 465956	Seating	54"		48.00
Repeat Classic by Hella Jongerius 462100 *	Seating	55"		450.00
Repeat Classic Print by Hella Jongerius 462160 *	Seating	55"		500.00
Repeat Classic Stripe by Hella Jongerius 462170	Seating	55"		130.00
Repeat Dot by Hella Jongerius 462110 *	Residential Seating	55"		375.00
Repeat Dot Print by Hella Jongerius 462130 *	Residential Seating	55"		425.00
Repeat Dot Ring by Hella Jongerius 462150	Seating	55"		130.00
Replica 399565	Walls	54"	2.07	28.00 ≈
Reply 901880	Systems & Upholstered Walls	66"		24.00
Revival 511471	Privacy Curtain	72"		35.00
Ring 466182	Seating	54"		41.00
Rise by Konstantin Grcic 466146	Seating	54"		52.00
Rove 466096	Outdoor Seating	54"		31.50
Row 511484	Privacy Curtain	72"		47.00
Ruban by Kvadrat 281940	Windows	55"		47.00
Rubric 466249	Seating	54"		44.00
Rule 466190	Outdoor Seating	54"		57.00
Runner 466108	Seating	54"		50.00
Runner Standard 466167	Seating	58"		32.50
Rustle 399899	Walls	54"		105.00 ≈
Sail On by Lawrence Weiner 399728	Walls	27"	22.22	150.00
Salon 458670	Seating	54"		87.00
Sari 399426	Walls	54"	1.63	22.00 ≈
Satellite by Kvadrat 283750	Windows	59"		51.00
Schema 466336	Seating	54"		46.00

≈ On quantities less than bolt size, a US \$3.00 per yard cutting charge will apply.

* Available in multiples of 1 panel only.

** Available in multiples of 4 yards only.

† Available in bolt/30 yard increments.

‡ Available in 2.1 yard increments.

US Price List 2016

PATTERN AND STYLE NUMBER	PRIMARY APPLICATION	WIDTH	PER SQ FT	PER YD
Scout 405601	Seating	54"		53.00
Scribe 466075	Seating	55"		51.50
Scrim 399556	Walls	52"	1.73	22.50 ‡
Scuba 464930	Seating	54"		40.00
Seam 466289	Seating	54"		35.00
Seed 399613	Walls	54"	7.41	100.00 ‡
Semaphore 511442	Privacy Curtain	72"		46.00
Semblance 283730	Windows	54"		15.50
Sentiment 2 511474	Privacy Curtain	72"		32.00
Sequence 466179	Outdoor Seating	54"		46.50
Set 511462	Privacy Curtain	72"		36.00
Shadow by Kvadrat 283370	Windows	55"		108.00
Shadowbox 466265	Seating	58"		49.00
Shantung 398390	Walls	54"	1.63	22.00 ‡
Sharkskin 2 901650	Upholstered Walls	54"		42.50
Sheath 399567	Walls	54"	2.44	33.00 ‡
Sheen 466246	Seating	54"		47.00
Showers by Alexander Girard®, 1958 399930	Walls	54"	2.14	29.00 ‡
Shuttle 466103	Seating	54"		50.00
Shuttle Standard 466168	Seating	54"		38.50
Sidestep 511460	Privacy Curtain	72"		16.00
Signal 466342	Seating	54"		46.00
Silk Canvas 465985	Residential Seating	57"		100.00
Sing 511490	Privacy Curtain	72"		34.00
Skein 466170	Seating	54"		37.00
Sketch 901780	Systems & Upholstered Walls	66"		26.50
Skip 283729	Windows	54"		18.00
Skit 511470	Privacy Curtain	72"		36.00
Skyline by Kvadrat 283722	Windows	118"		98.00
Sleek 398040	Walls	54"	1.11	15.00 ‡
Small Dot Pattern by Charles and Ray Eames, 1947 458320	Seating	55"		98.00
Snap 465360	Seating	53"		80.00
Soft Tweed 466197	Seating	54"		90.00
Solo 901580	Systems & Upholstered Walls	66"		24.50
Sort 466273	Seating	54"		34.00
Spin 399833	Walls	52"	1.92	25.00 ‡
Spiral 901882	Systems & Upholstered Walls	66"		24.00
Splice 397200	Walls	54"	1.85	25.00 ‡
Sprout 511480	Privacy Curtain	72"		36.00
Square Cutter's Room by Rosemarie Trockel 399754	Walls	27"	22.22	150.00
Squares by Kvadrat 283692	Windows	59"		56.00
Stack 465990	Seating	54"		35.00

‡ On quantities less than bolt size, a US \$3.00 per yard cutting charge will apply.

* Available in multiples of 1 panel only.

** Available in multiples of 4 yards only.

† Available in bolt/30 yard increments.

‡ Available in 2.1 yard increments.

US Price List 2016

PATTERN AND STYLE NUMBER	PRIMARY APPLICATION	WIDTH	PER SQ FT	PER YD
Stamp Flowers by Sanaa 399743	Walls	27"	22.22	150.00
Star by Kvadrat 465966	Seating	55"		72.00
Static 399572	Walls	54"	1.19	16.00 ≍
Stature 466180	Seating	54"		38.00
Steady 465947	Seating	54"		37.00
Steady Crypton 465946	Seating	54"		49.00
Steelcut by Kvadrat 464470	Seating	55"		56.00
Steelcut Trio by Kvadrat 465906	Seating	55"		58.00
Stem 511479	Privacy Curtain	72"		35.00
Stitch 399618	Walls	36"	4.00	36.00 ≍
Stoplight Colour by Kvadrat 282290	Windows	55"		34.00
Strand 466194	Seating	55"		47.00
Stratum 399598	Walls	54"	1.41	19.00 ≍
Stride 466252	Seating	58"		40.00
Stripes by Paul Smith 463980	Seating	56"		128.00
Strum 466122	Seating	54"		46.00
Study 466269	Outdoor Seating	54"		68.00
Sudden 463000	Seating	54"		49.00
Summer Hours in Kensington by Jean Nouvel 399949	Walls	27"		150.00
Sunny by Alex Katz 399947	Walls	27"		150.00
Superweave by Alexander Girard®, 1966 466241	Residential Seating	54"		180.00
Surge 466314	Seating	57"		43.00
Surprise by Danskina 200110	Floors		65.00	
Swift 511467	Privacy Curtain	72"		37.00
Symmetry 399595	Walls	52"	1.77	23.00 ≍
System 399600	Walls	52"	1.92	25.00 ≍
Tabby 511488	Privacy Curtain	72"		42.00
Tabby Check 511487	Privacy Curtain	72"		45.00
Tabby Stripe 511486	Privacy Curtain	72"		45.00
Tag 511465	Privacy Curtain	72"		36.00
Tailor 466173	Seating	54"		37.50
Talc 283767	Windows	128"		55.00
Tally 465989	Seating	54"		49.50
Tandem 466321	Seating	54"		40.00
Tangram 466084	Seating	54"		83.00
Taut 399568	Walls	54"	1.56	21.00 ≍
Teatro 466309	Seating	55"		72.00
Technic 466226	Seating	56"		30.00
Tek-Wall 1002 399594	Walls	54"	1.63	22.00 ≍
Tek-Wall Annex 399650	Walls	54"	1.85	25.00 ≍
Tek-Wall Band 399684	Walls	54"	2.15	29.00 ≍
Tek-Wall Brace 399629	Walls	54"	2.15	29.00 ≍

≍ On quantities less than bolt size, a US \$3.00 per yard cutting charge will apply.

* Available in multiples of 1 panel only.

** Available in multiples of 4 yards only.

† Available in bolt/30 yard increments.

‡ Available in 2.1 yard increments.

US Price List 2016

PATTERN AND STYLE NUMBER	PRIMARY APPLICATION	WIDTH	PER SQ FT	PER YD
Tek-Wall Brink 399823	Walls	54"	1.85	25.00 ☞
Tek-Wall Channel 399385	Walls	54"	1.78	24.00 ☞
Tek-Wall Drift 399522	Walls	54"	2.04	27.50 ☞
Tek-Wall Fable 399797	Walls	54"	2.22	30.00 ☞
Tek-Wall Foil 399601	Walls	54"	2.07	28.00 ☞
Tek-Wall Guide 399578	Walls	54"	1.93	26.00 ☞
Tek-Wall Hyphen 399798	Walls	54"	2.52	34.00 ☞
Tek-Wall Lanyard 399635	Walls	54"	2.96	40.00 ☞
Tek-Wall Lintel 399686	Walls	54"	1.93	26.00 ☞
Tek-Wall Measure Backed 399436	Walls	54"	2.15	29.00 ☞
Tek-Wall Ombre 399300	Walls	54"	2.30	31.00 ☞
Tek-Wall Pane 399683	Walls	54"	2.22	30.00 ☞
Tek-Wall Parable 398650	Walls	54"	2.00	27.00 ☞
Tek-Wall Ramble 399537	Walls	54"	2.00	27.00 ☞
Tek-Wall Reed 399636	Walls	54"	2.96	40.00 ☞
Tek-Wall Rhombus 399641	Walls	54"	1.93	26.00 ☞
Tek-Wall Ripple 399685	Walls	54"	2.15	29.00 ☞
Tek-Wall Scatter 399390	Walls	54"	1.63	22.00 ☞
Tek-Wall Solstice 399637	Walls	54"	3.11	42.00 ☞
Tek-Wall Steward 399547	Walls	56"	1.93	27.00 ☞
Tek-Wall Stream 399389	Walls	54"	1.70	23.00 ☞
Tek-Wall Subject 399535	Walls	56"	1.86	26.00 ☞
Tek-Wall Sum 399592	Walls	54"	1.70	23.00 ☞
Tek-Wall Tint 399682	Walls	54"	1.78	24.00 ☞
Tek-Wall Truss 399821	Walls	54"	2.14	29.00 ☞
Tek-Wall Verge 399822	Walls	54"	2.22	30.00 ☞
Tek-Wall View 399432	Walls	54"	1.93	26.00 ☞
Telary 466151	Seating	54"		78.00
Tend 466352	Seating	54"		48.00
Tenor 399832	Walls	54"		72.00 ☞
Terrace 466114	Outdoor Seating	54"		46.00
Thatch 399612	Walls	54"	6.22	84.00 ☞
The Firm by Sarah Morris 465999	Seating	56"		198.00
The Story of My Life 464670	Seating	54"		115.00
Thistle 397540 **	Walls	36"	2.67	24.00 ☞
Ticker 466304	Seating	54"		45.00
Tile 399621	Walls	36"	2.78	25.00 ☞
Till 399837	Walls	54"	1.25	17.00 ☞
Tilt 466256	Seating	55"		50.00
Time 300 by Kvadrat 283687	Windows	118"		58.00
Tiraz 394502	Walls	54"	1.44	19.50 ☞
Tokyo by Kvadrat 466247	Seating	59"		78.00

☞ On quantities less than bolt size, a US \$3.00 per yard cutting charge will apply.

* Available in multiples of 1 panel only.

** Available in multiples of 4 yards only.

† Available in bolt/30 yard increments.

‡ Available in 2.1 yard increments.

US Price List 2016

PATTERN AND STYLE NUMBER	PRIMARY APPLICATION	WIDTH	PER SQ FT	PER YD
Tone 399603	Walls	52"	1.58	20.50 ≈
Tonica by Kvadrat 460850	Seating	55"		49.00
Tonus by Kvadrat 460800	Seating	55"		57.00
Tonus Meadow by Kvadrat 466319	Seating	55"		57.00
Toostripe by Alexander Girard®, 1965 462260	Seating	54"		128.00
Topstitch 283460	Residential Windows	53"		70.00
Town 399330 **	Walls	36"	4.67	42.00 ≈
Trace 398600 **	Walls	36"	5.22	47.00 ≈
Tracks 399599	Walls	54"	1.33	18.00 ≈
Trait 464830	Seating	54"		43.00
Transport 466176	Seating	56"		94.00
Traverse 399587	Walls	54"	1.48	20.00 ≈
Tread 466113	Seating	54"		54.00
Treat 464510	Seating	54"		52.50
Trees by Hella Jongerius 466195	Seating	53"		89.00
Trellis 466244	Seating	54"		54.00
Tremor 466045	Seating	54"		50.00
Trio 466088	Seating	54"		73.00
Tune 511464	Privacy Curtain	72"		35.00
Turn 466037	Seating	54"		52.50
Twice 465909	Seating	58"		37.00
Twine 466009	Seating	53"		49.00
Twinkle 399642	Walls	52"	1.73	22.50 ≈
Ume by Toyo Ito 399741	Walls	27"	22.22	150.00
Unisol by Verner Panton, 1965 461160	Seating	55"		105.00
Unit 901889	Systems & Upholstered Walls	66"		28.00
Urban 466079	Seating	54"		48.50
Varied Stripe by Paul Smith 399656	Walls	54"	2.15	29.00 ≈
Vary 465933	Seating	54"		38.50
Vases by Hella Jongerius 466164	Seating	54"		74.00
Vellum 283775	Windows	122"		65.00
Velvet Stripe 466279	Seating	55"		130.00
Venn 464360	Seating	54"		49.00
Vest 399703	Walls	36"	3.55	32.00 ≈
Vestige 466259	Seating	54"		50.00
Vineyard by Hella Jongerius 466133	Seating	54"		74.00
Voyage 456801	Seating	54"		97.00
Waft 399834	Walls	52"	1.92	25.00 ≈
Waterborn by Kvadrat 466097	Seating	55"		105.00
Watercolor Flowers by Sanaa 399745	Walls	27"	22.22	150.00
Waxed Cotton Leno 283320	Residential Windows	44"		170.00
Waxen 466078	Seating	54"		36.50

≈ On quantities less than bolt size, a US \$3.00 per yard cutting charge will apply.

* Available in multiples of 1 panel only.

** Available in multiples of 4 yards only.

† Available in bolt/30 yard increments.

‡ Available in 2.1 yard increments.

US Price List 2016

PATTERN AND STYLE NUMBER	PRIMARY APPLICATION	WIDTH	PER SQ FT	PER YD
Wedge 466272	Seating	58"		51.00
Weimar 461980	Seating	53"		73.00
Whirl 463800	Seating	56"		37.00
Whirlwind 394001	Walls	52"	1.96	25.50 ‡
Whisk 399020	Walls	54"	1.56	21.00 ‡
Winding by Kvadrat 283756	Windows	130"		88.00
Wink 511491	Privacy Curtain	72"		34.00
Wire Gentle by Danskina 200200	Floors		90.00	
Wire Tough by Danskina 200210	Floors		90.00	
Wiwa Stories by Beatriz González 399946	Walls	27"		150.00
Wool Challis 282480	Windows	55"		82.00
Wool Rib 466198	Seating	53"		90.00
Wool Striae 466184	Seating	54"		136.00
Wool Veiling 283682	Residential Windows	54"		150.00
Wool Velvet 466120	Seating	54"		162.00
Wrap 466231	Seating	54"		39.00
Zeze by Kvadrat 283708	Windows	53"		46.00
Zoom by Kvadrat 282860	Windows	66"		46.00
Zulu by Kvadrat 283705	Windows	118"		52.00

‡ On quantities less than bolt size, a US \$3.00 per yard cutting charge will apply.

* Available in multiples of 1 panel only.

** Available in multiples of 4 yards only.

† Available in bolt/30 yard increments.

‡ Available in 2.1 yard increments.

flair
21

RETAIL CHART PRICING

P U B L I S H E D J A N U A R Y 2 0 1 6

phone 800.845.0918 • flair21.com • fax 888.574.2747

TABLE OF CONTENTS

Supplement Information Pages.....	1-4
Custom-Made: A Luxury in Itself.....	1
Dictionary of Terms.....	2-3
How to Order Custom Window Treatments.....	4
Pleated & Flat Draperies.....	5-13
Pleated Draperies.....	5-8
Grommet Draperies.....	9-10
Ring Top Draperies.....	11
Rod Pocket Draperies.....	12-13
Tiebacks.....	14
Top Treatments.....	15-20
Ripplefold.....	21-22
Cordon.....	23
Vertical Wrap.....	24-28
Vertical Wrap for Existing Systems.....	24
Vertical Wrap Complete.....	25-27
Valances for Wrap complete.....	28
Panel Glide.....	29-34
Panel Glide for Existing Systems.....	29
Panel Glide Complete.....	30-31
Panel Glide Complete Suggested Track Configurations.....	32-33
Panel Glide Complete with Motorization.....	34
Fabric Shade.....	35-41
Manual Board Mount Shade.....	36
Motorized Board Mount Shade.....	37
Manual Headrail Mount Shade.....	39
Motorized Headrail Mount Shade.....	40
Wide-Width (102"-130" Fabric) Pricing Charts.....	44-142
Pleated Draperies.....	44-49
Grommet Draperies.....	50-57
Ring Top Draperies.....	58-65
Rod Pocket Draperies.....	66-77
Top Treatments.....	78-87
Tiebacks.....	88-90
Ripplefold Draperies.....	91-98
Vertical Wrap for Existing Hardware.....	99
Vertical Wrap Complete.....	100-101
Panel Glide.....	102-103
Austrian Shade.....	104-106
Flat Roman Shade.....	107-112
Front Slat & Back Slat Roman Shade.....	113-118
Hobbled (5" Spacing) & Waterfall (7" Spacing) Roman Shade.....	119-124
Relaxed & Slouch Roman Shade.....	125-130
Butterfly Roman Shade.....	131-136
Shirred & Box Pleated Balloon Shade.....	137-142
Narrow-Width (50"-60" Fabric) Pricing Charts.....	144-248
Pleated Draperies.....	144-155
Grommet Draperies.....	156-171
Ring Top Draperies.....	172-187
Rod Pocket Draperies.....	188-203
Top Treatments.....	204-212
Tiebacks.....	213-214
Ripplefold Draperies.....	215-230
Panel Glide.....	231-236
Flat Roman Shade.....	237-238
Front Slat & Back Slat Roman Shade.....	239-240
Hobbled (5" Spacing) & Waterfall (7" Spacing) Roman Shade.....	241-242
Relaxed & Slouch Roman Shade.....	243-244
Butterfly Roman Shade.....	245-246
Shirred & Box Pleated Balloon Shade.....	247-248
Shipping Information.....	249
Warranty.....	250

CUSTOM-MADE: A LUXURY IN ITSELF!

flair21 window treatments are one-of-a-kind, uniquely hand-crafted to your specifications and come with features that are only available in true custom sewing.

DRAPERY

- Three pleat styles to choose from: Pinch Pleat, Bohemian Pleat, Goblet Pleat
- Three flat styles to choose from: Grommet, Ring Top, Rod Pocket
- Choose Eurohem or double-turned hem
- Draperies may be lined or unlined (chart pricing based on option selected)
- Room-darkening lining and interlining are available on select fabrics (surcharge)
- Extra-long lengths (surcharge) with seams hidden on the back of folds

TOP TREATMENTS

- Board mount, rod mount and swags with 20 styles to choose from
- Velcro attachment on select styles (surcharge)
- Pattern matching

RIPPLEFOLD

- Choose Eurohem or double turned hem
- Unlined, lined or self lined (chart pricing based on option selected)
- Extra-long lengths (surcharge) with seams hidden on the back of folds

CORDON

- Panels (up to 236" tall) are easily trimmed to any desired length / width and even angled or patterned (surcharge)
- Available with a velcro, rod pocket, shirring tape, grommet or snap tape header (surcharge)
- Use multiple colors in a linear or stacked method for a truly bold statement (surcharge)

VERTICAL WRAP

- Any width seamless¹ up to 19'
- Extra-long lengths (surcharge) with seams hidden on the back of folds
- Eurohem for a perfect hang

PANEL GLIDE

- Any width up to 19' with weighted bottoms
- Fabric protection shield sewn on the top of every panel
- Extra-long lengths available (surcharge)
- Unlined, lined or self lined (chart pricing based on option selected)

FABRIC SHADE

- Choice of board mount (with matching face fabric) or headrail mount (with built-in Velcro® attachment)
- Number of scallops variable (surcharge depending on fabric yardage)
- Repeat matching on multiple shades
- Valance and returns available on select styles

EMBELLISHMENTS (surcharges apply)

- Tiebacks:
 - Made out of fabric: 3 shapes, fabric of your choice
 - Tassel tiebacks: 2 styles, 12 colors
- Trim: 11 styles, 12 colors
- Banding: Fabric of your choice

Quality is always guaranteed with our policy to inspect every treatment prior to shipment! But in case we do miss something, our lifetime limited warranty² will catch it!

WE WISH YOU A LIFETIME OF ENJOYMENT WITH YOUR *flair21* CUSTOM WINDOW TREATMENTS!

¹Not seamless in the case of extra-long. ²Please refer to the last page of this document for details.

DICTIONARY OF TERMS

Banding — Strips of fabric that can be made from coordinating or contrasting fabric. The raw edges are turned under, and the fabric band is then attached to the treatment as a decorative accent.

Baton Draw — When a drapery is opened or closed by a hand-held baton attached to the master on the rod.

Baton Reinforcement — A plastic reinforcement, or stiffener, designed to strengthen the heading of a drapery for baton draw. The plastic is molded in such a way as to fit into the master on the rod. The baton is attached with a screw, through the fabric and reinforcement, into the master. This reinforcement is not used with clip-on baton.

Bias Cut — Fabric cut on the diagonal direction of the fabric. Fabrics have more give on the bias than straight up and down, or across the grain. Swags hang better when cut on the bias.

Board Mount — Referring to a top treatment or a shade being stapled to a dust board.

Board Width — The measurement of the actual face width of the board.

Bracket to Bracket — Measurement from the outside of one bracket to the outside of the opposite bracket.

Break — A small amount of fabric that lies on the floor.

Buckram — A stiffening material used in drapery headings to help hold the shape of the product.

Cascades — Fabric which is folded and falls in a zigzag fashion down the sides of a top treatment. Cascades are most commonly used with swags, and sometimes referred to as 'jabots.'

Center Draw — A pair of draperies which open and close from the center of the window. Also called a 'split draw' or 'center split.'

Contrast Lining — Fabric used to line a treatment, which is different from the face fabric. This term usually refers to fabric other than standard lining.

Cut Length — The length to which the fabric is cut. The size will include the finished length of the treatment as well as hems, headings, and any necessary allowance for pattern repeat.

Decorative Rod — A rod designed to show as part of the overall window treatment. It can be wood or metal in various finishes and colors.

Dust Board — A piece of wood, covered with fabric, and used as a base to hold a Top Treatment or Shade.

Dye Lot — A complete color run of a bolt of fabric in a specific dye batch. Dye lots may vary slightly from one batch to the next.

Eurohem — A bottom-sewn, weighted hem that provides an ideal drapery hang.

Finished Length — This is the total length of the finished treatment.

Finished Width — This is the total width (including face width, returns and overlaps) of a finished treatment.

Fullness — Extra fabric (pleated or gathered) on a drapery or top treatment to give volume and dimension.

Grommet — Metal rings attached to fabric in two pieces, with fabric sandwiched in between.

Heading — The top edge of a drapery or valance.

Headrail — Used to house controls and mount wraps, ripplefolds, glides, and certain shades. It is comprised of the track and all components necessary for the specific treatment.

Horizontal Trim or Band — Trim applied in a side-to-side fashion.

Jabot — Fabric which is folded and falls decoratively between two sections in a top treatment. The term 'jabot' is also sometimes used for fabric that is folded and falls in a zigzag fashion down the sides of a top treatment.

Leading Edge — The side of a curtain or drapery which faces the center of the window.

Leading Edge Allowance — An addition to the width of a one-way drapery to allow for the leading edge of the drapery to go beyond the end of the rod when closed.

Master — A piece of metal or plastic on the leading edge of the carriers on a drapery rod. The master pushes / pulls the carriers to open / close the drapery.

DICTIONARY OF TERMS

Overlap — The area in the center of a split-draw drapery where the two halves cross over one another in order to reduce the amount of light showing between the two. For panel glides, this is the area where one panel crosses over the next to reduce the light gap.

Panel — One-way drapery that opens from one side. Commonly used for patio or sliding doors. The term 'panel' also can refer to half of a pair or one section on a panel glide.

Pleats — A technique to create volume by folding the fabric and tacking it to hold the shape. There are many different types of pleats including Pinch Pleat, Bohemian and Goblet.

Pin Setting — Space between the top of the drapery pin and the top of drapery panel.

Pouf — Fabric gathered and shaped to form a 'rosette', which is used to finish a top treatment.

Puddle — A large amount of excess fabric that lies on the floor.

Railroad — When fabric is railroaded, the width of the fabric becomes the length. See the Fabric Pricing Guide for more information.

Repeats — The distance between the beginning of one complete pattern and the beginning of the next identical pattern. Fabrics may have a vertical repeat, horizontal repeat or both.

Returns — The distance from the front of the rod or board, back to the wall. On a pleated drapery, it is the space from the last pleat to the side of the panel.

Rod Mount — A top treatment being installed on a rod.

Rod Width — The size of the face of the rod (not including any returns or overlap). Can also be called the face width of the rod.

Rod Pocket Drapery — Draperies with a pocket sewn into the top (and sometimes the bottom) to allow a rod to slide through for a gathered treatment.

Sash Rod — A small rod designed to be mounted inside a window frame.

Self-Lined — Lining a treatment with the same fabric which is being used on the face of the treatment.

Selvage — A fabric edge that is woven to prevent fraying.

Shirred — When a fabric is gathered at the top of a treatment or on a rod.

Sill — A ledge on the bottom of a window opening.

Spring Back — When a panel is baton or hand drawn, it is common for the fabric to 'spring back' when released.

Straight Cut — Fabric cut in the direction in which it comes of the roll.

Stack Back — Amount of space taken up by the draperies when in the open position.

Swag — A top treatment which uses draping fabric folded to form pleats and a scallop shape on the bottom.

Tails — Fabric gathered on the ends of certain top treatments, usually with straight sides and bottom.

Take Up — The amount of length lost on a rod pocket drapery due to the thickness / dimension of the rod.

Tiebacks — Designed to hold draperies back from the window in a decorative way.

Top Treatment — A decorative feature installed at the top of a window. These can be board mount, rod mount, or hung by rings / hooks.

Traverse Rod — A drapery rod with a pulley mechanism to draw draperies open and closed. This type of rod is utilitarian in design and commonly hidden with a top treatment.

Valance — A top treatment, usually referring to one installed on a rod.

Vertical Trim or Band — Indicates that the band or trim will be applied in a vertical or up-and-down fashion.

Welt — A twisted, cotton cord, covered with fabric and applied to the treatment.

Width — A single cut of fabric. This term is usually used in connection with 54" or other non-railroaded fabrics. The term 'width' is also used when referring to the 'rod width' or 'finished width.'

HOW TO ORDER CUSTOM WINDOW TREATMENTS

- 1- Begin with the order form for the treatment style you have selected.
- 2- The following information is required on each order form:
 - Account name
 - Account number (If you do not yet have an account number, please contact customer service)
 - Shipping information
 - Sidemark on the order and purchase order number (if you use one)
 - Fabric and color number to be used for the order
 - Quantity and size information
 - Specify if the treatment will be motorized
 - Please fill in every applicable column on the order form. If you have any additional information or upgrades, please record it under 'special instructions'. For assistance please call Customer Service at 800.845.0918.
- 3- Send orders to flair21 by fax or email:
 - Fax: 888.574.2747
888.766.5895
888.245.1185
 - Email: customerservice@flair21.us
- 4- **You must sign the order**

ORDER CONFIRMATIONS

In our continual efforts to provide flawless service, you must verify all the information on your fax or email confirmation. This will ensure that we correctly interpret and follow your fabrication instructions. This helps eliminate errors before we begin fabrication of your drapery orders. Failure to check the order confirmation for accuracy will cost everyone time and money. Fabrication will begin on your product after sending the order confirmation by fax or email. Any changes will result in a change charge plus possible rework charges. Cancellations subject to accumulated charges.

Each order confirmation includes the following information:

- flair21 order number
- Account number
- Bill to and ship to information
- Estimated ship date
- PO number
- Sidemark for the order
- Payment Terms
- Carrier and delivery method
- Description of the fabric or fabrication
- Quantity of the fabric or fabrication order
- Total price of the order

NOTE: Our price charts make it easy to estimate the price of your window treatment based on standard widths and lengths. If your measurements fall in-between two sizes, your actual price (stated on the order confirmation) will be based on the EXACT width and length of your order. Pricing Charts do NOT reflect the additional yardage that may be required for pattern matching.

Shipping charges will be added at a \$20 flat-rate per order, with the exception of oversized/overweight shipments requiring LTL (see page 249 in this guide for additional information).

PLEATED & FLAT DRAPERIES

- Most flair21 and ADO Goldkante Collection fabrics offer the choice of Eurohem or a double-turned hem.
- Décor 54 fabrics always have a double-turned hem (4" is the standard turn, but larger sizes available upon request as an upgrade).
- Available unlined or lined (all of these linings are available with Eurohem or a double-turned hem):
 - flair21's 01000 lining in your choice of white (10), antique white (11), alabaster (12) or cream (15)
 - flair21's room-darkening 01002 lining in white (10) or antique white (11) (Only in combination with select flair21 fabrics; refer to the Style Recommendations at flair21.com)
- Interlining is recommended for use with silks, because this natural fiber is very UV sensitive. Interlining is also available for use with other lightweight fabrics. Interlining is always an upgrade.
- Panels are finished with corner weights (with the exception of open-weave fabrics).
- Double 1 ½" side hem is standard. Side hems are blind stitched (with the exception of open-weave fabrics).
- Lengths up to 126" will have a ¼" tolerance. Lengths over 126" will have a 1" tolerance.
- Maximum finished lengths are determined by the fabric collection and drapery style—see the details above each pricing chart. For extra long lengths, contact Customer Service for pricing.
- Trim or banding is available as an upgrade.

HOW TO MEASURE FOR DRAPERIES & PANELS

DECORATIVE RODS are designed to show as part of the overall window treatment. They can be wood or metal in a variety of colors and finishes. Many finial and end cap shapes and sizes are available to complement and complete the design statement. These rods can be used for draperies, side panels or top treatments.

Pleats will ride below the rod. Decorative rods are used with rings for pleated and ring top draperies, side panels or valances; they are used without rings for grommet and rod pocket draperies, valances or other top treatments. Select styles can be fitted with traverse hardware to be cord draw.

STANDARD TRAVERSE ROD is a metal rod strung with cords for controlling the draw of the draperies. The rod can be made to accommodate a split draw (for a pair of draperies), or a one way draw (for a single panel). The pleats will ride in front of the rod as they traverse. Standard traverse rods are only used for pleated draperies.

Decorator Tip: This rod is utilitarian in design, and it is common to hide it with a valance or other type of top treatment.

DRAPERY LENGTH

- Inside mount — Measure inside the casing to the floor or casing at the bottom of the window. Measure in three places, each side and middle. Use the smallest measurement. Subtract 1" for clearance to arrive at the finished length.
- Outside mount — Measure at least 2" to 4" above the window to the floor. Measure in three places, and use the smallest measurement. Subtract 1" for clearance, to arrive at the finished length.

PUDDLED DRAPERIES are a style in which the bottom hem rests on the floor. There are two looks within this relaxed style:

- Break — To create a break on the floor, add 2" to 4" to the length of the draperies instead of subtracting for clearance.
- Puddle — For a puddle effect, add 8" to 18" depending on the amount of puddle desired and the scale of the window.
- When ordering, be sure to include the amount of break or puddle, in the finished length. Breaking or Puddling draperies creates a very dramatic look. For safety, please be sure that there is ample floor space, for fabric to rest on the floor.

HOW TO MEASURE FOR DRAPERIES & PANELS

MEASURING A DECORATIVE ROD WITHOUT RINGS

- Measure the width of the space you want the panels to occupy on the rod.
- When ordering a stationary panel for each end of the rod, they are commonly ordered as two separate panels, or you can add the two together for a pair measurement.
- Remember to add return(s) if you desire and your panel style allows.
- For measuring length, see directions under each style description.

MEASURING A DECORATIVE ROD WITH RINGS—CENTER SPLIT / SPLIT DRAW

- The first / last ring should be between the bracket and the finial or end cap.
- The width of the rod is measured from the outside edge of the ring on one end of the rod, to outside edge of the ring on the opposite end of the rod. This is the face width or rod width.
- At the ends of the rod, measure the distance from the center of the rod to the wall, this is the return.
- If your decorative rod is fitted with traverse cord controls, the masters will cross over each other in the center of the rod, when closed. The space where they cross over is the overlap; the most common overlap size is 3 ½".
- For hand draw or baton draw, please note that the rings will not cross over each other in the center of the rod. However, you will still want to allow for a little extra fabric to overlap, which reduces the light gap in the center of your window. This is the overlap.
- When a panel is hand or baton drawn, it is common for the fabric to 'spring back' when released. Many decorators add extra in the width to allow for this. It is your choice whether or not to make this addition, and if so, how much.
- Add together the rod width, two returns (one on each end), one overlap and spring back (if desired). These will equal the finished width.
- Divide the finished width by 2, to find the width of each half of the pair or left and right panels.
- For length, measure from the bottom of the ring to your desired length.

MEASURING A DECORATIVE ROD WITH RINGS—ONE WAY DRAW

- The width of the rod is measured from the outside edge of the ring on the return end (this last ring should be between the bracket and finial or end cap) to the space between the bracket and finial or end cap on the opposite end of the rod. This is the face width or rod width.
- At the end of the rod, measure the distance from the center of the rod to the wall, this is the return.
- On the leading edge of the panel, there will be a space from the side of the panel to the first pleat, the standard size for this space is 3 ½". The minimum is 1 ½". You can enter the desired size in the box marked for overlap.
- When a panel is hand or baton drawn, it is common for the fabric to 'spring back' when released. Many decorators add extra in the width to allow for this. It is your choice whether or not to make this addition, and if so, how much.
- Add together the rod width, one return and spring back (if desired). These will equal the finished width.
- For length, measure from the bottom of the ring to your desired length

MEASURING A STANDARD TRAVERSE ROD—CENTER SPLIT / SPLIT DRAW

- Measure the width of the rod from end to end, this is the face width or rod width.
- At the ends of the rod, measure the distance from the front of the rod to the wall, this is the return.
- The masters will cross over each other in the center of the rod when closed. The space they cross over is the overlap. The most common overlap size is 3 ½".
- Add together the rod width, two returns (one on each end) and one overlap. These will equal the finished width.
- Divide the finished width by 2, to find the width of each half of the pair or left and right panels.
- For length, measure from the top of the rod to your desired length.

MEASURING A STANDARD TRAVERSE ROD—ONE WAY DRAW

- Measure the width of the rod from end to end, this is the face width or rod width.
- At the end of the rod, measure the distance from the front of the rod to the wall, this is the return.
- If you desire, you can add for the leading edge of the drapery to go beyond the end of the rod when closed. This is the leading edge allowance. It is your choice whether or not to make this addition, and if so, how much.
- On the leading edge of the panel, there will be a space from the side of the panel to the first pleat, the standard size for this space is 3 ½". The minimum is 1 ½". You can enter the desired space in the box marked for overlap.
- Add together the rod width, one return and the leading edge allowance (if desired). These equal the finished width.
- For length, measure from the top of the rod to your desired length.

PLEATED DRAPERIES

The pricing charts on the following pages are for pinch, goblet, bohemian, box, windsor, pencil and cartridge pleated draperies. Featured below are our top-selling pleat styles.

- A 4" buckram is standard, 5" buckram is available at no additional charge and an 8" or 10" buckram is available as an upgrade.
- Transparent buckram is available upon request; it is softer (and therefore less rigid) than the standard buckram.
- Specify your desired return size; the most common is 3 ½" and the minimum is 1 ½".
- The standard overlap is 3 ½", with a minimum of 1 ½". Please specify if other than standard.
- Draperies are pre-pinned, so please specify the pin setting.
- For pleated draperies being installed on a decorative rod, measure the length from the bottom of the ring to your desired length.
- For pleated draperies being installed on a standard traverse rod, measure the length from the top of the rod to your desired length.

SHIPPING: Pleated draperies will be fan folded with the buckram between the pleats, folded toward the back.

INSTALLING: When installing on a decorative rod with rings, do not re-fold the buckram. For a standard traverse rod, please re-fold the buckram toward the front, so the draperies can traverse correctly on the rod.

PINCH PLEAT DRAPERIES

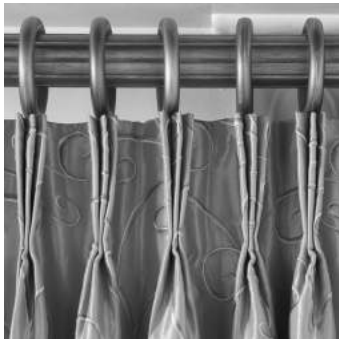

- Standard 3-finger pinch pleats (3pp) are hand folded to form 3 equal fingers.
- The fingers are folded together and tacked ½" up from bottom of the buckram (approximately 1" from the top). However, if the fabric is too thick, the tack will be below the buckram.
- The bottom of the drapery will have a Eurohem or a double-turned hem—your choice, as the fabric allows.

Pleat Recommendations Based on Fullness:

- 2 ½ – 4 fullness: 3pp
- >4 fullness: 4pp or 5pp

BOHEMIAN PLEAT DRAPERIES



- Pleats are hand folded to form 3 equal fingers.
- Pleats are tacked ½" down from top and ¼" in from the front.
- The bottom of the drapery will have a Eurohem or a double-turned hem—your choice, as the fabric allows.

GOBLET PLEAT DRAPERIES

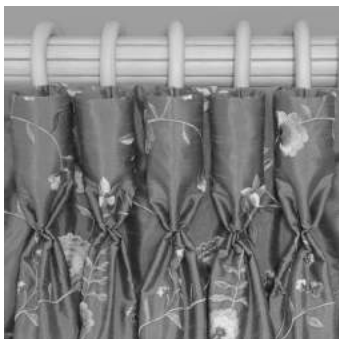

- Pleats are hand folded to form 3 equal fingers.
- Tack will be ½" below the buckram.
- At installation, the pleat is opened and filled with plastic tubes (included with order), to fill the goblets.
- The bottom of the drapery will have a Eurohem or a double-turned hem—your choice, as the fabric allows.
- The minimum buckram for Goblet pleats is 5".
- 2 ½" fullness is recommended.

Decorator Tip: The pleats will not stack tight because of the goblets' dimension; those dimensions are determined by the fullness and fabric weight. Please allow for this when estimating stack space for your client.

ORDERING PLEATED DRAPERIES

- 1- Determine the quantity, and if it is a pair or single panel.
- 2- Choose a pleat style and fullness.
- 3- Select a fabric design and color for your pleated draperies. (Make sure your selection is suitable for drapery treatments. See the Recommended Applications at flair21.com.)
- 4- Mark the desired hem style (Eurohem or double-turned hem, as the fabric allows) and size.
- 5- Select a lining design, color and hem. NOTE: room-darkening lining cannot be used with sheer fabrics.
- 6- Indicate if interlining is desired. NOTE: Interlining is recommended for select silks and faux silks (see the Properties and Recommended Applications at flair21.com).
- 7- Determine the finished width and length of your drapery (including rod width, overlap, return(s) and any other additions).
- 8- Record the return size and overlap size.
- 9- Calculate the width of the left and/or right panels.
- 10- Indicate your desired pin setting (please refer to the [flair21](http://flair21.com) Drapery Order Form for available choices).
- 11- For a quick customer estimate: identify the fabric series number at flair21.com or in the appropriate Fabric Pricing Guide. Then, in this Chart Pricing Guide, find the chart matching your fabric width (wide- or narrow-width), fullness, lining and hem selections. Follow down the left column to your series number and go across to your width (if your width is between sizes, go up to the next higher size). For narrow-width fabrics, you will need to locate the correct chart for your series number, and then find the price based on your length and width.
- 12- Choose (if desired) tieback(s) shape and finish with pricing on pages 87–89 and 212-213 in this Chart Pricing Guide.
- 13- Add the subtotals from steps 11 and 12 to determine your total retail price.

PRICE EXAMPLE: PLEATED DRAPERIES

- 1- One pair
- 2- Bohemian Pleat, 2 ½ fullness
- 3- Fabric 1212 0/362-51 (Narrow-Width)
- 4- All Décor 54 fabrics have double-turned, 4" standard hems
- 5- Lining 01000 0/10-118 with 3" hem (the lining hem is typically 1" less than the face fabric hem)
- 6- No interlining desired
- 7- Finished width 60", finished length 92"
- 8- Return: 3 ½", overlap: 3 ½"
- 9- Left panel: 30", right panel: 30"
- 10- Pin setting: ¼"
- 11- Series 14 (found in Fabric Pricing Guide). Go to page 146 for pleated draperies (using narrow-width fabric) with 2.5 fullness, lined. Look at the chart for Series 14, go down the left side to 96" (must round up) and across to 63" (again, rounding up) = \$790.
- 12- No tiebacks desired.
- 13- \$790 (Estimated) Total

FLAT DRAPERIES

- Flat draperies do not have pleats—the fullness on the rod should be dressed as desired by the decorator.
- Since flat draperies need to be dressed every time they are moved, they work best as stationary panels.
- When ordering a stationary panel for each end of the rod, they are commonly ordered as two separate panels, or you can add the two together for a pair measurement.

SHIPPING: Flat draperies are flat folded for shipment.

GROMMET DRAPERIES



- The top features a fabric-covered buckram, sandwiched between 2 round metal pieces, forming the grommet. Visit flair21.com to view the grommet color selections available.
- The bottom of the drapery will have a Eurohem or a double-turned hem—your choice, as the fabric allows.
- We suggest you allow at least $\frac{3}{8}$ " of space between the inside diameter (ID) of grommet and the diameter of the rod. This space is necessary for the grommets to easily slide on the rod.
NOTE: Grommets slide easiest on a metal rod with ample clearance.
- Space between grommets will depend on the width of panel, the size of the grommet, and the number of grommets.
- There must be an even number of grommets on each panel.

• We suggest spacing the grommets approximately 6" apart. Customer service can compute the number of grommets, or you can request a certain number of grommets and customer service will compute for viability.

• The minimum space required from the side of the panel to the edge of the first / last grommet is $1\frac{1}{2}$ ", this is also the standard. A larger space can be requested.

• 3" grommets require a minimum of 5" buckram.

• If you desire a return, please indicate on the order form. The return is measured from the edge of the last grommet to the side of the panel.

MEASURING LENGTH: Measure from the top of the rod to your desired length. The top of the panel will be slightly above the top of the rod. To find the amount to add for this, please see the column "Add for Finished Length" in the chart below. **Your ordered length will be the flat finished length of the drapery; flair21 makes no additions or subtractions.**

GROMMET SIZE #	INSIDE DIAMETER	OUTSIDE DIAMETER	MAX. ROD DIAMETER	ADD FOR FINISHED LENGTH	GROMMET COLORS AVAILABLE					
					BRASS	NICKEL	BLACK	SATIN	GOLD	COPPER
#2	$\frac{3}{8}$ "	$\frac{3}{4}$ "	Euro Wire Rod	$\frac{5}{8}$ "	✓	✓	✓	✓		
#4	$\frac{1}{2}$ "	1"	Wire Rod - $\frac{1}{4}$ "	$\frac{3}{4}$ "	✓	✓	✓			
#6	$\frac{3}{4}$ "	$1\frac{1}{4}$ "	$\frac{1}{4}$ " - $\frac{1}{2}$ "	$\frac{3}{4}$ "	✓	✓	✓	✓	✓	✓
#8	$1\frac{1}{8}$ "	$1\frac{13}{16}$ "	$\frac{1}{2}$ " - $\frac{7}{8}$ "	$\frac{7}{8}$ "	✓	✓	✓	✓	✓	✓
#10	$1\frac{7}{16}$ "	$2\frac{5}{16}$ "	$\frac{7}{8}$ " - $1\frac{1}{4}$ "	1"	✓	✓	✓	✓	✓	✓
#12	$1\frac{9}{16}$ "	$2\frac{7}{16}$ "	$1\frac{1}{4}$ " - $1\frac{1}{2}$ "	1"	✓	✓	✓	✓	✓	✓
#15	2"	$2\frac{7}{8}$ "	$1\frac{1}{2}$ "	1"	✓	✓	✓	✓	✓	✓
#18	$2\frac{1}{2}$ "	$3\frac{3}{4}$ "	2"	$1\frac{1}{8}$ "	✓	✓	✓	✓	✓	✓
#20	3"	$4\frac{1}{4}$ "	$2\frac{1}{2}$ "	$1\frac{1}{8}$ "	✓	✓	✓	✓	✓	✓

ORDERING GROMMET DRAPERIES

- 1- Determine the quantity, and if it is a pair or single panel.
- 2- Choose desired fullness and grommet size, color and approximate spacing.
- 3- Select a fabric design and color for your grommet draperies. (Make sure your selection is suitable for drapery treatments. See the Recommended Applications at flair21.com.)
- 4- Mark the desired hem style (Eurohem or double-turned hem, as the fabric allows) and size.
- 5- Select a lining design, color and hem. NOTE: room-darkening lining cannot be used with sheer fabrics.
- 6- Indicate if interlining is desired. NOTE: Interlining is recommended for select silks and faux silks (see the Properties and Recommended Applications at flair21.com).
- 7- Determine the finished width and length of your drapery.
- 8- Calculate the width of the left and/or right panels.
- 9- For a quick customer estimate: identify the fabric series number at flair21.com or in the appropriate Fabric Pricing Guide. Then, in this Chart Pricing Guide, find the chart matching your fabric width (wide- or narrow-width), fullness, lining and hem selections. Follow down the left column to your series number and go across to your width (if your width is between sizes, go up to the next higher size). For narrow-width fabrics, you will need to locate the correct chart for your series number, and then find the price based on your length and width.
- 10- Choose (if desired) tieback(s) shape and finish with pricing on pages 88–90 and 213-214 in this Chart Pricing Guide.
- 11- Add the subtotals from steps 9 and 10 to determine your total retail price.

PRICE EXAMPLE: GROMMET DRAPERIES

- 1- One panel
- 2- 2 ½ fullness — 2" Nickel Grommets with 6" spacing
- 3- Fabric 00117 1/12-118 (Wide-Width)
- 4- Eurohem chosen
- 5- Lining 01000 1/10-118 with Eurohem
- 6- No interlining
- 7- Finished width 40", finished length 92"
- 8- Left panel: 40"
- 9- Series 22 (found in Fabric Pricing Guide). Go to page 53 for grommet draperies (using wide-width fabric) with 2.5 fullness, lined with Eurohem. Go down the left side to Series 22 and across to 48" (round up) = \$579.
- 10- No tiebacks desired.
- 11- \$579 (Estimated) Total

RING TOP DRAPERIES



- The top of each panel is soft—no buckram is used—it is finished with a fabric-covered micro welt. There is a 4" fabric face on the back of the panel at the top.
- The bottom of the drapery will have a Eurohem or a double-turned hem—your choice, as the fabric allows.
- Clip rings are suggested for use on the top (not included with draperies).
- The number of clip rings used is a design feature to be decided by the decorator. The larger the space, the more the top will relax. Relaxing at the top can cause a slight relaxing at the bottom of the drapery, so be sure to allow enough clearance at the bottom of your drapery.
- Any desired return can be achieved by where the last clip ring is attached.
- A contrasting, fabric-covered micro welt is available as an upgrade.

MEASURING LENGTH: Measure from inside the clip, which will hold the fabric, to your desired length.

ORDERING RING TOP DRAPERIES

- 1- Determine the quantity, and if it is a pair or single panel.
- 2- Choose desired fullness.
- 3- Select a fabric design and color for your ring top draperies. (Make sure your selection is suitable for drapery treatments. See the Recommended Applications at flair21.com.)
- 4- Mark the desired hem style (Eurohem or double-turned hem, as the fabric allows) and size.
- 5- Select a lining design, color and hem. NOTE: room-darkening lining cannot be used with sheer fabrics.
- 6- Indicate if interlining is desired. NOTE: Interlining is recommended for select silks and faux silks (see the Properties and Recommended Applications at flair21.com).
- 7- Determine the finished width and length of your drapery.
- 8- Calculate the width of the left and/or right panels.
- 9- For a quick customer estimate: identify the fabric series number at flair21.com or in the appropriate Fabric Pricing Guide. Then, in this Chart Pricing Guide, find the chart matching your fabric width (wide- or narrow-width), fullness, lining and hem selections. Follow down the left column to your series number and go across to your width (if your width is between sizes, go up to the next higher size). For narrow-width fabrics, you will need to locate the correct chart for your series number, and then find the price based on your length and width.
- 10- Choose (if desired) tieback(s) shape and finish with pricing on pages 88–90 and 213–214 in this Chart Pricing Guide.
- 11- Add the subtotals from steps 9 and 10 to determine your total retail price.

PRICE EXAMPLE: RING TOP DRAPERIES

- 1- One panel
- 2- 2 ½ fullness
- 3- Fabric 00116 1/10-118 (Wide-Width)
- 4- Eurohem chosen
- 5- Unlined
- 6- No interlining
- 7- Finished width 40", finished length 92"
- 8- Right panel: 40"
- 9- Series 24 (found in Fabric Pricing Guide). Go to page 60 for ring top draperies (using wide-width fabric) with 2.5 fullness, unlined with Eurohem. Go down the left side to Series 24 and across to 48" (rounding up) = \$469.
- 10- No tiebacks desired.
- 11- \$469 (Estimated) Total

ROD POCKET DRAPERIES



- The soft top can be made with a pocket alone, or a pocket with a heading.
- When the drapery is gathered on the rod, the heading appears as a ruffle.
- Remember to include the heading when calculating the finished length.
- There are no returns on rod pocket draperies.
- When the fabric is gathered on the rod, it causes the overall length to draw up, this is called “rod take-up”.
- We recommend you add to your length to allow for this loss, but it is your choice to make this addition, and if so, how much.
- The amount of loss is influenced by: diameter of the rod, size of the pocket, fullness of the drapery and thickness of the fabric.

- See the chart below for approximate rod take-up and suggested pocket size for various rod types and sizes.
- If your selected fabric is thick or your drapery has a high fullness, you may want to order a larger pocket.
- Your ordered length will be the flat finished length (including pocket and any heading); flair21 makes no additions or subtractions.

SINGLE POCKET

- This style has a pocket on the top of the drapery.
- It can be made with or without a heading.
- The bottom of the drapery will have a Eurohem or a double-turned hem—your choice, as the fabric allows.

MEASURING LENGTH: Measure from the top of the rod to your desired length, and make any desired additions for rod take-up and/or heading.

DOUBLE POCKET

- This style has a pocket on both the top and bottom of the panel.
- It can be made with or without headings.

MEASURING LENGTH: Measure from the top of the top rod to the bottom of the bottom rod, and make any desired additions for rod take-up and/or heading.

HOURGLASS PANEL

- A double pocket with the center angled to achieve an hourglass shape.
- Gathered center area is 1/3 of the total rod width. A straight tieback with Velcro closure finishes the center.
- It can be made with or without headings.

MEASURING LENGTH: Measure from the top of the top rod to the bottom of the bottom rod, and make any desired additions for rod take-up and/or heading. flair21 will make all calculations for hourglass shape.

ROD TYPE	ROD SIZE	SUGGESTED POCKET SIZE	APPROX. ROD TAKE-UP
Sash Rod / Standard Curtain Rod	1"	1 1/2"	1/2"
Round Pole—Wood or Metal	1"	2 3/8"	5/8"
Round Pole—Wood or Metal	1 1/4"	2 3/4"	3/4"
Round Pole—Wood or Metal	1 3/8"	3"	1"
Round Pole—Wood or Metal	2"	4 1/4"	1 1/4"
Round Pole—Wood or Metal	2 1/2"	5"	1 3/4"
Round Pole—Wood or Metal	3"	5 3/4"	2 1/4"
Continental I	4 1/4"	5 1/2"	5/8"
Continental I	2 1/4"	4 1/4"	5/8"
Faux Wood Valance	3 5/8"	5"	3/4"

ORDERING ROD POCKET DRAPERIES

- 1- Determine the quantity, and if it is a pair or single panel.
- 2- Choose desired fullness, and specify single or double pocket, pocket size(s) (top/bottom) and heading size (if applicable).
- 3- Select a fabric design and color for your rod pocket draperies. (Make sure your selection is suitable for drapery treatments. See the Recommended Applications at flair21.com.)
- 4- Mark the desired hem style (Eurohem or double-turned hem, as the fabric allows) and size.
- 5- Select a lining design, color and hem. NOTE: room-darkening lining cannot be used with sheer fabrics.
- 6- Indicate if interlining is desired. NOTE: Interlining is recommended for select silks and faux silks (see the Properties and Recommended Applications at flair21.com).
- 7- Determine the finished length and width of your drapery.
- 8- Calculate the width of the left and/or right panels.
- 9- For a quick customer estimate: identify the fabric series number at flair21.com or in the appropriate Fabric Pricing Guide. Then in this Chart Pricing Guide find the chart matching your fabric width (wide- or narrow-width), pocket/hem, fullness and lining selections. Follow down the left column to your series number and go across to your width (if your width is between sizes, go up to the next higher size). For narrow-width fabrics, you will need to locate the correct chart for your series number, and then find the price based on your length and width.
- 10- Choose (if desired) tieback(s) shape and finish with pricing on pages 88–90 and 213-214 in this Chart Pricing Guide.
- 11- Add the subtotals from steps 9 and 10 to determine your total retail price.

PRICE EXAMPLE: ROD POCKET DRAPERIES

- 1- One panel
- 2- 2 ½ fullness — 3" Double Pockets
- 3- Fabric 03005 0/11-118 (Wide-Width)
- 4- Double Pocket—no bottom hem
- 5- Lining 01000 0/10-118
- 6- No interlining
- 7- Finished length 92", finished width 40"
- 8- Left panel: 40"
- 9- Series 10 (found in Fabric Pricing Guide). Go to page 75 for double rod pocket draperies (using wide-width fabric) with 2.5 fullness, lined. Go down the left side to Series 10 and across to 48" (round up) = \$377.
- 10- No tiebacks desired.
- 11- \$377 (Estimated) Total.

TIEBACKS

- Tiebacks have Dacron filling inside for a slightly padded effect. (Buckram can be requested instead, at no additional charge).
- Small rings are sewn on the back for installation (with the exception of tiebacks for an hourglass panel, which have Velcro® closure).
- Tiebacks are available in three standard widths. Please indicate on the order form if you want a size other than standard.

SHAPE & FINISH OPTIONS



Straight Diagram



Straight Standard – 3.5"



Straight with trim (on bottom)



Straight with cord (all the way around)

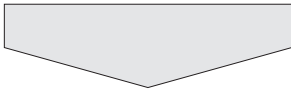

Tapered Diagram



Tapered – 2" sides, 4" center



Tapered with trim (on bottom)



Tapered with cord (all the way around)



Contoured Diagram



Contoured – 2" sides, 4" center



Contoured with trim (on bottom)



Contoured with cord (all the way around)

BOARD MOUNT TOP TREATMENTS

- Treatment styles, details and pictures below.
- 3 ½" return is standard, 5 ½" and 7 ½" returns available as an upgrade.
- Maximum width for one section is up to 92" (depending on the style chosen); oversized widths 92" – 184" will be hinged.
- Oversized boards shipped without hinging will be shipped LTL with additional charges.

SHAPED KICK PLEAT VALANCE



- Center scallop with angled ends, self lined
- Evenly spaced kick pleats approximately 16"
- Board mounted, not a washable treatment
- Top finished with ¼" welt
- Optional Velcro® with no welt (only with wide-width fabric)
- Number of scallops will be determined by the treatment width
- Specify length of center scallop; short point will be 2" shorter, ends will be 2" longer.

UPGRADES: Interlining • Contrast welt • Trim • Contrast lined • Specify number of scallops

ARCH-SHAPED VALANCE



- Board mounted, not a washable treatment
- Top finished with ¼" welt
- Optional Velcro® with no welt (only with wide-width fabric)
- Self lined
- Specify short point, long point will be 13 ½" longer
- Number of center box pleats will be determined by the treatment width

UPGRADES: Interlining • Contrast welt • Trim • Contrast lined • Specify number of box pleats

BOX PLEATED VALANCE

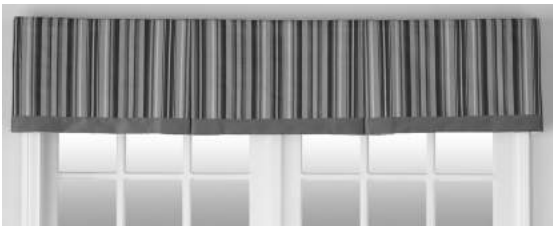

- A tailored, box pleated valance (shown with band on bottom)
- Board mounted, not a washable treatment
- Self lined
- Specify length 10" – 24"
- Pleats spaced approximately 17" apart
- Half pleat on corner

UPGRADES: Interlining • Trim • Band on bottom • Specify pleat spacing • Velcro (only with wide-width fabrics)

SCALLOP-SHAPED VALANCE



- Board mounted, not a washable treatment
- Top finished with ½" welt
- Optional Velcro® with no welt (only with wide-width fabric)
- Self lined
- Space between jabots is approximately 15"
- Specify length of scallops; jabots will be 2" shorter than scallops

UPGRADES: Interlining • Trim • Contrast welt • Contrast lining • Specify pleat spacing

ROD MOUNT TOP TREATMENTS

Rods not included. Treatment styles, details and pictures below.

GATHERED SLEEVE VALANCE



- 3 ½" sleeve
 - 5 ½" sleeve
 - Sheers will be 3X fullness
 - Drapery weight fabrics will be 2.5X fullness
 - Double layer (available only with wide-width fabrics) if specified
- UPGRADES: Specify fullness • Specify alternate pocket size

GROMMET VALANCE



- Length up to 24"
 - Lined
 - Specify grommet size and color
 - Space between grommets is approximately 6"
- UPGRADES: Interlining • Trim • Banding • Lengths over 24"

GATHERED SLEEVE VALANCE (WITH TOP & BOTTOM HEADERS)



- 3 ½" sleeve has 1 ½" headings on top and bottom
 - 5 ½" sleeve has 2" headings on top and bottom
 - Sheers will be 3X fullness
 - Drapery weight fabrics will be 2.5X fullness
 - Double layer (available only with wide-width fabrics) if specified
- UPGRADES: Specify fullness • Alternate pocket size • Alternate header size

PLEATED VALANCE

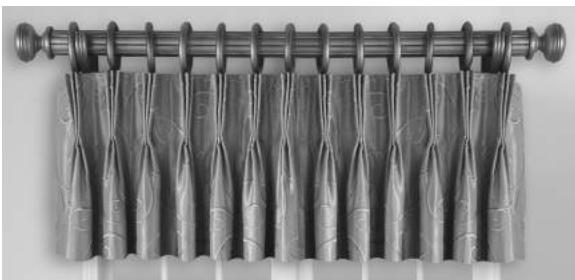

- Length up to 24"
 - Lined
 - Specify pleat style
 - Pinch and bohemian pleat will have a 4" buckram
 - Goblet pleat will have a 5" buckram
- UPGRADES: Interlining • Trim • Banding • Length over 24"

RING TOP VALANCE



- Length up to 24"
 - Lined
 - Micro welt covered in same fabric
 - Clip rings are suggested for use on the top (not included)
 - The number of clips used is a design feature determined by the decorator
- UPGRADES: Interlining • Trim • Banding • Length over 24" • Contrast-covered micro welt

ROD MOUNT TOP TREATMENTS

Rods not included. Treatment styles, details and pictures below.

ROD POCKET VALANCE

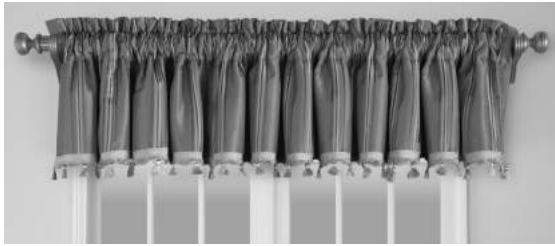

- Length up to 24"
- Lined
- Specify pocket size
- Specify header size (if desired)

UPGRADES: Interlining • Trim • Banding • Lengths over 24" • Contrast covered micro welt

BOARD MOUNT SWAGS

- Treatment styles, details and pictures below.
- 3 ½" return is standard, 5 ½" and 7 ½" returns available as an upgrade.
- Maximum width for one section is up to 92" (depending on the style chosen); oversized widths 92" – 184" will be hinged.
- Oversized boards shipped without hinging will be shipped LTL with additional charges.

BELL SWAG VALANCE



- Board mounted, not a washable treatment
- Contrast lined
- Swags are cut on the bias, unless otherwise requested
- Specify length: 16", 18" or 20"
- Swag width approximately 26"
- Number of swags determined by treatment width — minimum width is 31"

UPGRADES: Interlining • Trim • Banding • Specify number of swags • Velcro (only with wide-width fabrics)

TRADITIONAL SWAG VALANCE



- Board mounted, not a washable treatment
- Cascades contrast lined
- Swags are cut on the bias, unless otherwise requested
- Swag lined with standard lining
- Swag length is 18"
- Cascades up to 36"
- Number of swags determined by treatment width — minimum width is 30"
- For multiple swags, please specify swag placement (see page 19 for a diagram)

UPGRADES: Interlining • Trim • Banding on bottom of swag
Specify number of swags • Velcro (only with wide-width fabrics)
• Choice of lining on swag and/or cascade • Cascade length up to 110"

ROD MOUNT SWAGS

Rods not included. Treatment styles, details and pictures below.

ROUNDED SWAG VALANCE WITH CASCADE



- Swags are cut on the bias, unless otherwise requested
- Self lined
- One cascade (left OR right) — (two shown with contrast lining over pleated panels)

UPGRADES: Interlining • Trim • Contrast lining

POLE SWAG



- Swags are cut on the bias, unless otherwise requested
- Self lined
- Velcro provided for mounting to the rod
- Number of swags determined by treatment width
- Specify swag placement (see page 19 for a diagram)

- Swag sets 60" – 80" will have an 18" drop with cascades 12" wide
- Swag sets 80" – 144" will have a 24" drop with cascades 16" wide
- Cascades up to 36" long, please specify desired length

UPGRADES: Interlining • Trim • Specify number of swags • Returns
• Cascades up to 110" long

POINTED BELL SWAG



- Swags are cut on the bias, unless otherwise requested
- Bell swag is self lined

UPGRADES: Interlining • Trim • Contrast lining

ROUNDED SWAG

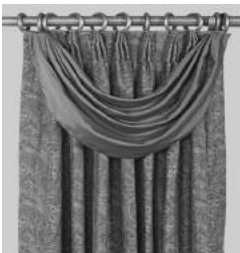

- Swags are cut on the bias, unless otherwise requested
- The swag is self lined

UPGRADES: Interlining • Trim

SWAG PLACEMENT & OPTIONS

For traditional Board Mount and Pole Swags.

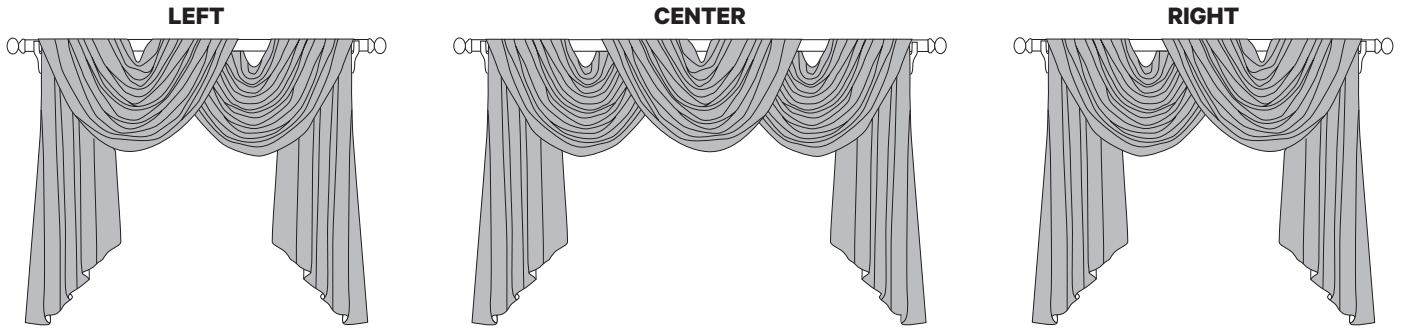

SWAG STANDARDS & OPTIONS

MIN & MAX WIDTH PER SWAG

BELL SWAG VALANCE		
# Swags	Min. board width	Max. board width
1	17"	41"
2	31"	79"
3	45"	117"
4	59"	155"
5	73"	192"
6	87"	192"
7	101"	192"

TRADITIONAL SWAG VALANCE		
# Swags	Min. board width	Max. board width
1	30"	50"
2	45"	85"
3	60"	120"
4	75"	155"
5	90"	184"
6	105"	184"
7	120"	184"

POLE SWAG		
# Swags	Min. pole width	Max. pole width
1	30"	54"
2	50"	98"
3	70"	142"
4	90"	186"
5	110"	230"
6	130"	274"

STANDARD NUMBER OF SWAGS PER WIDTH

BELL SWAG VALANCE		
# Swags	Min. board width	Max. board width
1	17"	30 7/8"
2	31"	66"
3	66 1/8"	92"
4	91 1/8"	118"
5	118 1/8"	144"
6	144 1/8"	170"
7	170 1/8"	192"

TRADITIONAL SWAG VALANCE		
# Swags	Min. board width	Max. board width
1	30"	48"
2	48 1/8"	72"
3	72 1/8"	96"
4	96 1/8"	120"
5	120 1/8"	144"
6	144 1/8"	168"
7	168 1/8"	184"

POLE SWAG		
# Swags	Min. pole width	Max. pole width
1	30"	50"
2	50 1/8"	92"
3	92 1/8"	124"
4	124 1/8"	156"
5	156 1/8"	188"
6	188 1/8"	220"

POUF SWAGS

Rods not included. Treatment styles, details and pictures below.

STRAIGHT TOP, MULTIPLE SWAG WITH TAILS AND POUFS



- Wide-width fabric only
- Number of swags determined by treatment width; swags are cut on the bias
- Self lined
- Tails and poufs attached
- Tail length up to 36", please specify
- Ring mount, please specify ring-to-ring measurement
- Minimum width is 48" — Maximum width is 144"

UPGRADES: Tails up to 110" long • Specify the number of swags • Use 2 colors of the same fabric

RELAXED TOP, SINGLE SWAG WITH TAILS AND POUFS



- Wide-width fabric only
- Swags are cut on the bias
- Self lined
- Tails and poufs attached
- Tail length up to 36", please specify
- Ring mount, please specify ring-to-ring measurement
- Minimum width is 36" — Maximum width is 120"

UPGRADES: Tails up to 110" long • Use 2 colors of the same fabric

RELAXED TOP, MULTIPLE SWAG WITH TAILS AND POUFS



- Wide-width fabric only
- Number of swags determined by treatment width; swags are cut on the bias
- Self lined
- Tails and poufs attached
- Tail length up to 36", please specify
- Ring mount, please specify ring-to-ring measurement
- Minimum width is 48" — Maximum width is 144"

UPGRADES: Tails up to 110" long • Specify the number of swags • Use 2 colors of the same fabric

STRAIGHT TOP, SINGLE SWAG WITH TAILS AND POUFS



- Wide-width fabric only
- Number of swags determined by treatment width; swags are cut on the bias
- Self lined
- Tails and poufs attached
- Tail length up to 36", please specify
- Ring mount, please specify ring-to-ring measurement
- Minimum width is 36" — Maximum width is 120"

UPGRADES: Tails up to 110" long • Use 2 colors of the same fabric

RIPPLEFOLD

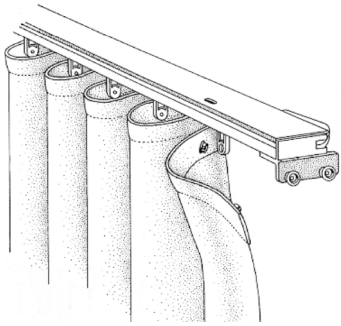

- Panels manufactured specifically for the Kirsch Ripplefold drapery snap system. The drapery panels snap onto carriers that swivel, eliminating 'flat' drapery areas. flair21 uses Kirsch specifications when making Ripplefold draperies.
- A permanently stiffened, nylon snap tape is stitched to the top of a flat panel.
- The snaps on the nylon snap tape are 4 ¼" on center (regardless of the drapery fullness).
- Headings suspended under the track cannot tip or sag.
- The bottom of the drapery will have a Eurohem or a double-turned hem—your choice, as the fabric allows.
- Available unlined or lined (all of these linings are available with a Eurohem or double-turned hem):
 - flair21's O1000 lining in your choice of white (10), antique white (11), alabaster (12) or cream (15)
 - flair21's room-darkening O1002 lining (cannot be used with sheer fabrics) in white (10) or antique white (11)
- Interlining is recommended for use with silks, because this natural fiber is very UV sensitive. Interlining is also available for use with other lightweight fabrics. Interlining is always an upgrade.
- Panels are finished with corner weights (with the exception of open-weave fabrics).
- Double 1 ½" side hem is standard. Side hems are blind stitched (with the exception of open-weave fabrics).
- Lengths up to 134" will have a ¼" tolerance. Lengths over 134" will have a 1" tolerance.
- Maximum finished lengths are determined by the fabric design and hem—see the details above each pricing chart. Extra long lengths are available, for pricing, please submit a quote request via fax or email.
- Trim or banding applied to the leading edge or the hem, is available as an upgrade.
- The fullness is determined by the spacing of the carriers on the rod (not by the snap tape), draperies can be 60%, 80%, 100% or 120% fullness
- On the rod, there is a master on each leading edge. One on a one-way draw, two on a split draw. There are two different types of master:
 - Butt-Master (this type cannot be baton draw): Butt together in center for a continuous looking flow in drapery folds, on a split draw. Butt master is to be used for a one-way draw.
 - Overlap Master (can be cord draw or baton draw): Overlap in center for best privacy, also assures less light gap.
- flair21 will add an extra snap on the leading edge or return end of the drapery, according to Kirsch directions, depending on the type of master.

HOW TO MEASURE FOR RIPPLEFOLD

- Measure the width of the rod from end to end; this is the face width or rod width. Do not add for return or overlap.
- Divide this number in half to find the panel size, left and right.
- To determine the fullness on an existing rod. Measure the space between carriers.
 - 60% (1.6 Fullness) = 2 5/8" space
 - 80% (1.8 Fullness) = 2 3/8" space
 - 100% (2 Fullness) = 2 1/8" space
 - 120% (2.2 Fullness) = 1 7/8" space
- You will need to determine the type of master for the order form:
 - Butt Master: each master will have two snaps on the side. The two snaps on the left master will 'butt' up to the two snaps on the right master.
 - Overlap Master: the masters will cross over each other in the center of the rod when closed.
- Overlap Masters are available with two types of batons:
 - Clip on style: the baton clips onto the master (no baton reinforcement is used).
 - Screw in style: the baton is attached through the fabric and into the master with a screw. This style needs a baton reinforcement attached to the leading edge of the drapery. A baton reinforcement is an upgrade.
- The Kirsch specifications include fabric to go around the end of the rod. The fabric will hide the end of the rod, but will not go all the way to the wall. If you would like the fabric return to go all the way to the wall, please tell us the amount we need to add. On the return end of the rod, measure from the back of the rod end cap to the wall. (Please enter this amount separately; do NOT add it to the rod/face width. flair21 will add this extra amount as necessary.)
- Length: Measure from the bottom of the rod to your desired length.

ORDERING RIPPLEFOLD

- 1- Determine the quantity, and if it is a pair or a panel.
- 2- Select a fabric design and color for your Ripplefold treatment. (Make sure your selection is suitable for Ripplefold. See the Recommended Applications at flair21.com.)
- 3- Mark the desired hem style (Eurohem or double-turned hem, as the fabric allows) and size.
- 4- Select a lining design, color and hem. NOTE: room-darkening lining cannot be used with sheer fabrics.
- 5- Indicate if interlining is desired. NOTE: Interlining is recommended for select silks and faux silks (see the Properties and Recommended Applications at flair21.com).
- 6- Choose your desired type of master: Butt Master or Overlap Master.
- 7- Determine your desired fullness: 60%, 80%, 100% or 120%.
- 8- Determine your rod width and finished length.
- 9- Calculate the width of the left and/or right panels.
- 10- Indicate any extra fabric desired on the return.
- 11- For a quick customer estimate: identify the fabric series number at flair21.com or in the appropriate Fabric Pricing Guide. Then, in this Chart Pricing Guide, find the chart matching your fabric width (wide- or narrow-width), fullness, lining and hem selections. Follow down the left column to your series number and go across to your width (if your width is between sizes, go up to the next higher size). For narrow-width fabrics, you will need to find your price based on the length and width.

PRICE EXAMPLE: RIPPLEFOLD

- 1- One panel
- 2- Fabric 00101 1/602-118 (Wide-Width)
- 3- Eurohem
- 4- Unlined
- 5- No interlining
- 6- Overlap Master
- 7- 120% Fullness
- 8- Rod width 92", finished length 86"
- 9- Right panel: 92"
- 10- No extra on return
- 11- Series 24 (found in Fabric Pricing Guide). Go to page 97 for Ripplefold treatments (using wide-width fabric), 120% fullness, unlined with Eurohem. Go down the left side to series 24 and across to 96" (must round up) = \$843 (Estimated) Total.

CORDON



Cordon's wide range of colors and unique design makes it easy to create a modern, elegant statement in residential and commercial spaces. Cordon catches the eye and makes a bold statement in offices, stores, suites and exhibition stands—as window treatments, room partitions or a variety of other uses.

- Sold in various lengths (see below), per yard, with a 4" header, or upgrade with a velcro, rod pocket, shirring tape, grommet or snap tape header.
- Guaranteed five years not to shrink, stretch or fade.
- Fiber Content: 100% Polyester — Inherently Flame Retardant (IFR)
- Available in 15 unique colors with everything from black and white to gold and candy apple red.

TO CLEAN: Before washing, remove any drapery hooks and tie the single strings together at the top, middle and bottom. Wash on the warm cycle in a lingerie bag or pillow case. After washing, remove the ties and re-hang damp. **Do not put in the dryer.**

ITEM	LENGTH	RETAIL PRICE / YARD	SERIES NUMBER
Cordon 9705	90"	\$140	34
	106"	\$178	37
	126"	\$178	37
	157"	\$200	38
	197"	\$200	38
	236"	\$200	38

FINISHING OPTIONS & PRICING

For finished, ready-to-hang panels, choose your desired length, multiply by the number of yards required, and then add the (per yard) finishing prices below. **NOTE:** Remember to multiply the desired finishing option(s) by the number of yards ordered.

Special finishing, such as pattern cuts and multicolor panels (linear or stacked), is available; contact customer service for details.

CUT TO LENGTH: \$41 PER YARD

VELCRO, TAPE OR ROD POCKET HEADER: \$54 PER YARD



SHIRRING TAPE

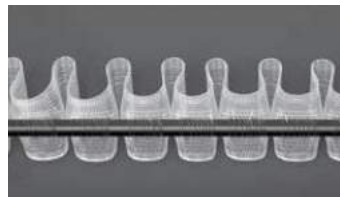

2" BACK-TAB TAPE

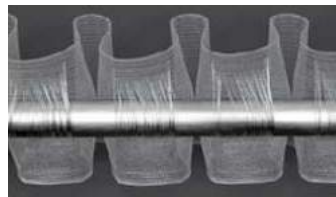

4" BACK-TAB TAPE



VELCRO TAPE

GROMMET HEADER: \$94 PER YARD

- Metal grommets
- Choose 1" or 1.5" (inside) diameter
- Colors: Brass, Brushed Brass, Copper, Black, Steel or Chrome
- Typical spacing between grommets is 5.5"-7", or you may specify
- MUST have an even number of grommets

VERTICAL WRAP FOR EXISTING SYSTEMS

- Like a slipcover that easily installs over existing verticals.
 - The fabric has a snap tape sewn across the top and a tack at the bottom to make a pocket.
 - Snap the fabric over the top of the vane, and then slip the vane into the bottom pocket.
- **For existing vertical blinds with 3 ½" vanes only.**
- **Maximum vane length is 114". flair21 will add ¼" of fabric to cover the vane.** Extra long wraps (for vanes longer than 114") are available, for pricing, please submit a quote request via fax or email.
- **All Vertical Wraps feature Eurohem only. The Eurohem will hang just below the vane.**
 - A ¼" is added to the specified vane length to completely cover the vane.
 - It is important to verify that there is sufficient clearance between the bottom of the vane and the floor or window sill to accommodate the Eurohem.

TO CLEAN: simply unsnap, wash in warm water on the gentle cycle, re-hang damp, smooth any folds (to minimize wrinkles) and air dry.

TO STEAM: leave the fabric attached at the top, remove the vane from the bottom tack, hold the fabric away from the vanes, and steam from top to bottom. Do not put steam directly onto the PVC vanes, as this may cause the vanes to warp. After steaming the fabric, reinsert the vane into the bottom of the wrap.

NOTE: When installing Vertical Wraps on an existing vertical, keep in mind that if the corners of your vanes are not rounded they may snag the fabric. Therefore, take care when slipping the vanes into the bottom pockets. **Snags in the fabric pocket are NOT a manufacturing defect**, and no credit will be issued.

ORDERING A VERTICAL WRAP FOR EXISTING SYSTEMS

- 1- Determine quantity needed (for a split draw, you will need to order two panels).
- 2- Select a fabric design and color for your Vertical Wrap. (Make sure your selection is suitable for a Vertical Wrap. See the Recommended Applications at flair21.com.)
- 3- Give the number of vanes and the exact length of the vanes. **NOTE: The treatment will be ¼" longer to completely cover the vanes; WATCH OUT FOR CLEARANCE TO FLOOR/WINDOW SILL!**
- 4- For a quick customer estimate: identify the fabric series number at flair21.com or in the appropriate Fabric Pricing Guide. Then, in this Chart Pricing Guide, match that series number with the number of vanes from the existing vertical.
- 5- You can also order a Shirred sleeve for a valance when ordering a Vertical Wrap without the hardware. Specify rod width, fullness, pocket size and header size (if necessary) when ordering. We suggest ordering the sleeve slightly larger than the valance that you are covering to allow for smooth installation and adjustments.

PRICE EXAMPLE: VERTICAL WRAP FOR EXISTING SYSTEMS

- 1- Pricing for one panel
- 2- Fabric: 03005 1/901-118 (Wide-Width)
- 3- Number of vanes: 22, and length of vanes: 87"
- 4- Series 10 (found in Fabric Pricing Guide). Go to the Vertical Wrap chart on page 99. Since the number of vanes is 22, you will need to go up to 25. Go down the left side to series 10 and across to 25 = \$576 (Estimated) Total
- 5- No Shirred sleeve desired

VERTICAL WRAP COMPLETE



- Heavy-duty vertical track system capable of rotating and traversing at widths up to 240" for residential and commercial applications.
- The system is completed with the flair21 fabric of your choice.
- The fabric has snap tape sewn across the top, a tack at the bottom to make a pocket, and Eurohem, to hang below the bottom of the vane.
- Each system comes with your choice of valance: Shirred fabric sleeve (matching your wrap), faux wood valance (in white or ivory) or (with a surcharge) reeded hardwood valance (choice of four colors).
- The vanes are 3 1/2" flat with rounded corners, and available in three colors: white, ivory, and alabaster.

• **Maximum width is 240". Maximum overall length (from top of headrail to bottom of Eurohem) is 114", and the minimum overall length is 55".** Extra long wraps are available up to 192", for pricing, please submit a quote request via fax or email.

OPERATION: Child-safe cord, baton or motorized. Available stack configurations: one-way or split. The (24", 36", 48" or 60" white) baton-controlled system is only available on one-way systems. There is a surcharge for motorized tracks, call customer service for more info.

HEAD RAIL: Made of extruded aluminum alloy, 1 1/2" wide X 1" high. The extrusion has a wall thickness of .045" with a brushed aluminum finish.

TILT SHAFT: Made of extruded aluminum alloy, 1/4" diameter, single groove.

CARRIER: Each carrier is 5/16" wide with two wheels, molded of self lubricating plastic. The carriers have a geared clutch system for overload protection and a steel clutch spring to reinforce positive action. There also is a unique stabilizer bar designed to provide smooth traversing. The hooks of the carrier are made of clear, ultra-violet resistant lexan and are replaceable even while the unit is installed. The carriers provide the vanes with 185° rotation capability to provide full vane closure and will stay in position unless reset. Maximum vane weight 1 1/4 pounds.

CONTROL CHAIN: The control chain is made of Celcon beads molded onto a nylon cord. One full cycle of the chain will self align the vanes.

SPACER LINKS: The spacers, made of flexible, corrosion proof, stainless steel, are interlocked between carriers to provide smooth traversing.

END CAPS: All Vertical Wrap tracks are manufactured with completely covered end caps, concealing internal parts for a custom, finished appearance. The end caps are molded of self lubrication plastic and their unique design allows for only 1/4" light gap on the control end of an inside mount vertical. The Vertical Wrap system comes with a 4-to-1 ratio rotation mechanism (46" of control chain required to rotate 180°).

Headrail	
Depth:	1 1/2"
Height:	1"

Space from Center of Carrier to Wall	
Minimum:	2 5/8"
Maximum:	4 3/4"

Space Required for Inside Mount (IB)	
Flush Mount	4"
Fully Recessed (including vanes)	5"

Maximum Space Between Mounting Brackets:	15"
---	-----

Minimum Width:	10"
-----------------------	-----

Maximum Width (Split Draw):	240"
------------------------------------	------

Maximum Width (One-Way Draw):	170"
--------------------------------------	------

Maximum Weight (Baton Control):	14 lbs.
--	---------

Minimum Overall Length:	55"
--------------------------------	-----

Maximum Vane Length:	192"
-----------------------------	------

STACK: 5/16" wide carrier and 1/4" light gap end cap allows for very tight stacking. A 122" one-way draw track stacks to just 15" of space. (See stack back chart on page 27)

TO CLEAN: simply unsnap, wash in warm water on the gentle cycle, rehang damp, smooth any folds (to minimize wrinkles) and air dry.

TO STEAM: leave the fabric attached at the top, remove the vane from the bottom tack, hold the fabric away from the vanes, and steam from top to bottom. Do not put steam directly onto the PVC vanes, as this may cause the vanes to warp. After steaming the fabric, reinsert the vane into the bottom of the wrap.

NOTE: The final vane count for Vertical Wrap complete systems is dependent upon the mount and type of draw chosen.

Keep in mind that the corners of the vanes may snag the fabric. Therefore, take care when slipping the vanes into the bottom pockets. **Snags in the fabric pocket are NOT a manufacturing defect**, and no credit will be issued.

Widths and lengths larger than 105" will be shipped LTL with additional charges. (See page 249 of this guide for shipping charges).

HOW TO MEASURE FOR VERTICAL WRAP SYSTEMS

INSIDE MOUNT

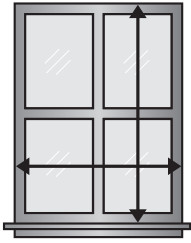

- For the **length**, use the smallest measurement from inside the top casing of the window to inside the bottom casing or the floor.
- To find the **width**, measure inside the window casing from left to right.
- **flair21 will take $\frac{3}{8}$ " deduction for width and length** to allow for clearance.
- Standard return for the valance on an inside mount is 3 $\frac{1}{2}$ ", if no return is needed please specify.
- Inside mount Vertical Wraps will have a 'false vane' on the return side (i.e. a one-way draw will have one false vane and a split draw will have two false vanes). The false vane(s) will not turn with the true vanes—this helps eliminate any light gap. If you choose not to have a false vane(s), please indicate on your order.

OUTSIDE MOUNT

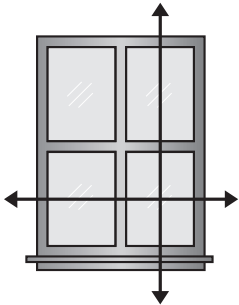

- Measure the **width** and **length** you wish to cover (NOTE: This is typically 2" to 4" from the outside edge of the window—from the top of the headrail, to the bottom of the Eurohem).
- **flair21 does NOT make any deductions** or additions.

DESIGNER'S TIP

- For the **length**, it is good to **measure from 4" to 6" above the casing** to just above the floor. Hanging your treatment higher will give your room the illusion of taller ceilings and bigger windows.
- You can also create the illusion of larger windows by **allowing the treatment to stack next to the window** instead of covering it. The track should **extend beyond the window**—depending on the width of the treatment—to allow for stack-back. See the chart on the next page to help determine the stack back space required.

ORDERING VERTICAL WRAP COMPLETE

- 1- Determine quantity needed.
- 2- Select a fabric design and color for your Vertical Wrap. (Make sure your selection is suitable for Vertical Wraps. See the Recommended Applications at flair21.com.)
- 3- Determine desired mount (inside or outside) and stack (left, right or center split).
- 4- Determine exact blind width (headrail width) and length (from the top of the headrail to the bottom of the fabric).
- 5- For a quick estimate: identify the fabric series number at flair21.com or in the appropriate Fabric Pricing Guide. Then, in this Chart Pricing Guide, match that series number with blind width under the appropriate chart for the desired mount/stack.
- 6- Choose desired vane color (white, ivory or alabaster).
- 7- Choose desired control position (left or right). (The cord is the same length as the vane unless specified otherwise).
- 8- Choose desired valance. A faux wood or shirred sleeve valance can be ordered at no charge. A Hardwood Reeded Pole Valance is available as an upgrade (see page 28 for available finials and finishes).

NOTE: Pricing charts are according to the mount and draw chosen. Follow the instructions below, and go to the appropriate chart.

PRICE EXAMPLE: VERTICAL WRAP COMPLETE

- 1- Pricing for one system
- 2- Fabric: 03005 1/12-118 (Wide-Width)
- 3- Outside mount, stack left
- 4- 112" x 90 $\frac{1}{2}$ "
- 5- Series 10 (found in Fabric Pricing Guide). Go to the Outside Mount One-Way Vertical Wrap chart on page 101. Since the width is 112", you will need to go up to 120" on the chart. Go down the left side to series 10 and across to 120" = retail price of \$1362
- 6- Vane color: white
- 7- Control: left
- 8- Valance: Reeded fascia in mahogany color with returns. (7 $\frac{1}{2}$ " is the standard for wood valance return). Wood valance upgrade pricing is on page 28.
 - 112" + 7 $\frac{1}{2}$ " + 7 $\frac{1}{2}$ " = 127" or 10 $\frac{1}{2}$ ', so round up to 11' x \$25 = \$275
 - System price of \$1362 + valance upgrades at \$275 = \$1637 (Estimated) Total
 - If finials or end caps are used, take the face width (rounded up to the nearest foot) and add the cost of the finials/end caps.

VERTICAL WRAP OPENING, STACK BACK & TRACK SIZE NEEDED

Use the charts below to find the stack back and track size needed for your window/door opening. All measurements are in inches.

ONE WAY		
Opening To Clear	Stack Back	Track Size Needed
7 1/8	3	10
9 7/8	3 1/4	13 1/8
12 3/4	3 5/8	16 1/4
15 1/2	3 7/8	19 3/8
18 3/8	4 1/4	22 1/2
21	4 1/2	25 1/2
23 7/8	4 7/8	28 5/8
26 5/8	5 1/8	31 3/4
29 1/2	5 1/2	34 7/8
32 1/4	5 3/4	38
35 1/8	6 1/8	41 1/8
37 7/8	6 3/8	44 1/4
40 3/4	6 3/4	47 3/8
43 3/8	7	50 3/8
46 1/4	7 3/8	53 1/2
49	7 5/8	56 5/8
51 7/8	8	59 3/4
54 5/8	8 1/4	62 7/8
57 1/2	8 5/8	66
60 1/4	8 7/8	69 1/8
63 1/8	9 1/4	72 1/4
65 3/4	9 1/2	75 1/4
68 5/8	9 7/8	78 3/8
71 3/8	10 1/8	81 1/2
74 1/4	10 1/2	84 5/8
77	10 3/4	87 3/4
79 7/8	11 1/8	90 7/8
82 5/8	11 3/8	94
85 1/2	11 3/4	97 1/8
88 1/4	12	100 1/4
91	12 3/8	103 1/4
93 3/4	12 5/8	106 3/8
96 5/8	13	109 1/2
99 3/8	13 1/4	112 5/8
102 1/4	13 5/8	115 3/4
105	13 7/8	118 7/8
107 7/8	14 1/4	122
110 5/8	14 1/2	125 1/8
113 3/8	14 7/8	128 1/8
116 1/8	15 1/8	131 1/4
119	15 1/2	134 3/8
121 3/4	15 3/4	137 1/2
124 5/8	16 1/8	140 5/8
127 3/8	16 3/8	143 3/4
130 1/4	16 3/4	146 7/8
133	17	150
135 7/8	17 3/8	153 1/8
138 1/2	17 5/8	156 1/8
141 3/8	18	159 1/4
144 1/8	18 1/4	162 3/8
147	18 5/8	165 1/2
149 3/4	18 7/8	168 5/8
152 5/8	19 1/4	170

Maximum Width (One-Way Draw): 170"

SPLIT DRAW		
Opening To Clear	Stack Back	Track Size Needed
7 1/4	2 5/8	12 1/2
12 7/8	3	18 3/4
18 1/2	3 1/4	25
24	3 5/8	31 1/8
29 5/8	3 7/8	37 3/8
35 1/4	4 1/4	43 5/8
40 7/8	4 1/2	49 7/8
46 3/8	4 7/8	56
52	5 1/8	62 1/4
57 5/8	5 1/2	68 1/2
63 1/4	5 3/4	74 3/4
68 7/8	6 1/8	81
74 3/8	6 3/8	87 1/8
80	6 3/4	93 3/8
85 5/8	7	99 5/8
91 1/4	7 3/8	105 7/8
96 3/4	7 5/8	112
102 3/8	8	118 1/4
108	8 1/4	124 1/2
113 5/8	8 5/8	130 3/4
119 1/8	8 7/8	136 7/8
124 3/4	9 1/4	143 1/8
130 3/8	9 1/2	149 3/8
136	9 7/8	155 5/8
141 1/2	10 1/8	161 3/4
147 1/8	10 1/2	168
152 3/4	10 3/4	174 1/4
158 3/8	11 1/8	180 1/2
164	11 3/8	186 3/4
169 1/2	11 3/4	192 7/8
175 1/8	12	199 1/8
180 3/4	12 3/8	205 3/8
186 3/8	12 5/8	211 5/8
191 7/8	13	217 3/4
197 1/2	13 1/4	224
203 1/8	13 5/8	230 1/4
208 3/4	13 7/8	236 1/2
211 5/8	14 1/4	240

Maximum Width (Split Draw): 240"

VALANCES FOR VERTICAL WRAP SYSTEMS

STANDARD FAUX WOOD -OR- SHIRRED SLEEVE VALANCE

- The faux wood valance (in white or ivory) or shirred sleeve (in the same fabric as the wrap) is available at no charge.
- It is not necessary to give sizes, but you must fill in the appropriate information on the Vertical Wrap order form.
- The valance is 3 1/2" tall. For an outside mount, the standard return is 8 1/2" and 5 1/2" is the minimum. For an inside mount, the standard return is 2 1/2". Please specify if you do not want a return.



Faux Wood Valance

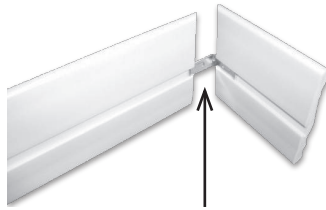

Returns are easily attached to the valance by sliding a small, L-shaped corner key into the groove on each corresponding piece.

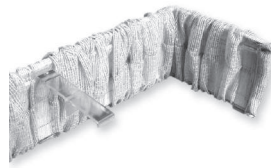

Shirred Sleeve Valance

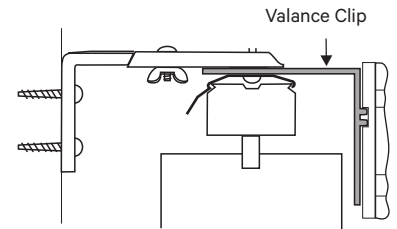

The valance is easily attached to the headrail by snapping the mounting clips (attached to the valance clips) onto the top of the headrail, then snapping the completed valance (with returns) onto the valance clips.

REEDED HARD WOOD VALANCE

- The hard wood valance fascia is available as an upgrade for Vertical Wrap complete systems in 16' reeded half-round poles.
- You have your choice of finials, end caps, or returns—available in four colors: Mahogany, Bronze, Black and Walnut.
- If no return is specified, the standard return on an outside mount is 7 1/2" and 3 1/2" on an inside mount.



Returns are hinged for easy installation.

The valance easily snaps onto the top of the headrail.

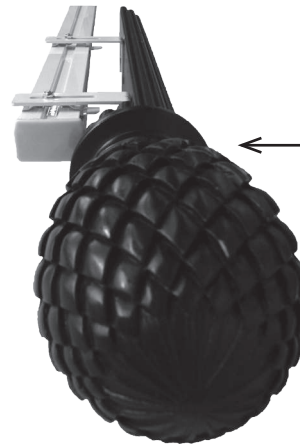

The finials screw into pre-drilled holes on both sides of the valance.

WOOD VALANCE PARTS

Part Number	Reeded Fascia 16'/Half Round	Retail Price
32-616-03	Mahogany	\$25 / Foot
32-616-17	Bronze	\$ 30 / Foot
32-616-45	Black	\$ 25 / Foot
32-616-55	Walnut	\$ 25 / Foot

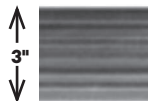

Part Number	Pine Cone Finial	Retail Price
34-115-03	Mahogany	\$54 Each
34-115-17	Bronze	\$66 Each
34-115-45	Black	\$54 Each
34-115-55	Walnut	\$54 Each

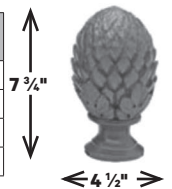

Part Number	Reeded Ball Finial	Retail Price
34-108-03	Mahogany	\$49 Each
34-108-17	Bronze	\$59 Each
34-108-45	Black	\$49 Each
34-108-55	Walnut	\$49 Each

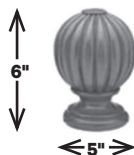

Part Number	End Cap	Retail Price
33-140-03	Mahogany	\$20 Each
33-140-17	Bronze	\$25 Each
33-140-45	Black	\$20 Each
33-140-55	Walnut	\$20 Each

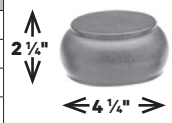

Part Number	Newport Finial	Retail Price
34-128-03	Mahogany	\$54 Each
34-128-17	Bronze	\$66 Each
34-128-45	Black	\$54 Each
34-128-55	Walnut	\$54 Each

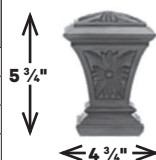

PANEL GLIDE FOR EXISTING SYSTEMS

- A fabric panel treatment with Velcro® sewn across the top of the panel.
- On the top of every panel is a clear fabric protection shield to prevent damage due to rubbing on the hardware.
- There is a weight bar in the bottom of each panel for added stability.
- **Maximum length is 110"**. Extra Long panels are available, for pricing, please submit a quote request via fax or email.
- The size and number of panels will be determined by your existing hardware.

ORDERING PANEL GLIDE FOR EXISTING SYSTEMS

- 1- Select a fabric design and color for your Panel Glide. (Make sure your selection is suitable for Panel Glide. See the Recommended Applications at flair21.com.)
- 2- Determine whether the panel will be unlined, lined or self-lined, and select the design and color.
- 3- Specify number of panels.
- 4- Specify the exact length and width of each panel (maximum length is 110").
- 5- For a quick estimate: identify the fabric series number at flair21.com or in the appropriate Fabric Pricing Guide. Then, in this Chart Pricing Guide, match that series number with the panel width under the appropriate chart based on your lining and fabric width. For narrow-width fabrics, you will need to find your price based on the length and width.

PRICE EXAMPLE: PANEL GLIDE FOR EXISTING HARDWARE

- 1- Fabric: 1215 0/972-118 (Narrow-Width)
- 2- Unlined
- 3- 5 Panels
- 4- 24" wide x 90" long
- 5- Series 12 (found in Fabric Pricing Guide). Go to the section for narrow-width fabrics and look at the chart for unlined panel glides on page 231. Go down the left side to series 12, 96" (rounding up) and across to 24" = retail price of \$151 per panel. Multiply by 5 for the number of panels = \$755 (Estimated) Total.

PANEL GLIDE COMPLETE

- A panel track up to 19' long with flat fabric panels that attach using Velcro®.
- The sliding metal profile with Velcro® strip is easily removed and reattached for convenient window access.
- There is a weight bar in the bottom of each panel for added stability.
- **Maximum width is 228". Maximum length (including headrail) is 112".** Extra Long panels are available, for pricing, please submit a quote request via fax or email.
- Choose wall or ceiling mount with a combination of 2 to 18 panels.
- One-way or center split; baton or cord drawn.
- **The average panel size is 20" to 30"**; the width of your panel is also the width of your stack back.
- With less than 3/8" space between panels, Panel Glide complete systems have a minimal mounting depth.
- The fabric panels can be unlined, lined or self-lined.
- On the top of every panel is a clear fabric protection shield to prevent damage due to rubbing on the hardware.
- All of the hardware required for installation is provided with every order.

PANEL GLIDE COMPLETE SPECIFICATIONS

Headrail Height:	5/8"
Space from top of mounting bracket to top of panel:	13/16"
Minimum space from center of 1st channel to wall:	1/2"
Distance between channels (center to center):	11/16"
Maximum Width (single track):	19'
Maximum Width (2 tracks butt end to end must be ceiling mount):	38'
Minimum Width:	20"
Standard Baton Size (other sizes available):	45"
Space Required for Inside Mount (IB)	
Two Channels: (not available with motorization)	2 1/8"
Three Channels:	2 3/8"
Four Channels:	3 1/16"
Five Channels:	3 5/8"

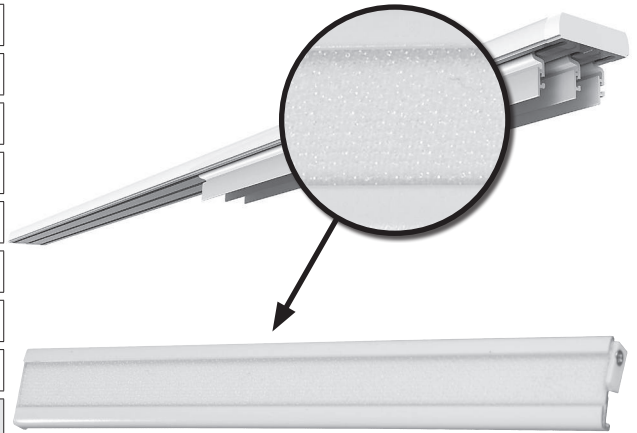

A Velcro® strip is adhered to the hardware for the attachment of the fabric panel.

Widths and lengths larger than 105" will be shipped LTL with additional charges. (See page 249 of this guide for shipping charges).

HOW TO MEASURE FOR PANEL GLIDE SYSTEMS

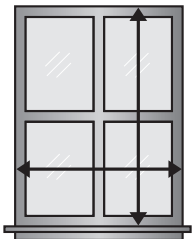

INSIDE MOUNT

- Measure the inside width of the window frame in three places: top, middle, and bottom. Then, measure the length in three places: both sides and the center. Use the smallest measurements.
- **flair21 will take 3/8" deduction for width and length.**

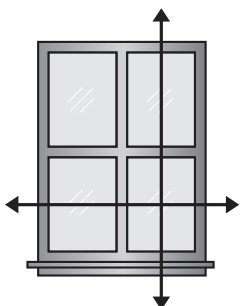

OUTSIDE MOUNT

- Measure the width and length you wish to cover (NOTE: This is typically 2"- 4" from the outside edge of the window—from the top of the headrail, to the bottom of the fabric panel).
- **flair21 DOES NOT make any deductions or additions.**

ORDERING PANEL GLIDE COMPLETE

- 1- Determine quantity.
- 2- Select a fabric design and color for your Panel Glide. (Make sure your selection is suitable for a Panel Glide system. See the Recommended Applications at flair21.com.)
- 3- Determine whether the panel will be unlined, lined or self-lined and specify the design and color. **NOTE: Interlining is recommended for select silks and faux silks** (see the Properties and Recommended Applications at flair21.com).
- 4- Specify the exact width of the headrail and total length of the treatment (maximum length is 112" from top of headrail to bottom of fabric panel).
- 5- Specify number of panels. **(See the suggested track configurations on pages 32 and 33).**
- 6- Determine stack: left, right or split draw.
- 7- Divide the width of the headrail by the number of panels and add your desired overlap for each panel. (4" is the standard overlap for glide panels, but you may specify if you want a different overlap size; this will determine the approximate width for each panel.)
- 8- For a quick estimate: identify the fabric series number at flair21.com or in the appropriate Fabric Pricing Guide. Then, in this Chart Pricing Guide, find the chart matching your fabric width (wide- or narrow-width) and lining selection. Match the series number with the panel width under the appropriate chart (for narrow-width fabrics, you will need to match the length with the width and series number). Multiply by the number of panels to determine your total panel price.
- 9- **See the hardware pricing chart at the bottom of this page to determine your Panel Glide hardware cost.** Add this to the total panel price for your grand total.
- 10- Determine mount: ceiling or wall.
- 11- Determine control: baton, cord left or cord right (specify cord length—standard is 1" shorter than the panel).

PRICE EXAMPLE: PANEL GLIDE COMPLETE

- 1- 1 system
- 2- Fabric: 00111 1/968-118 (Wide-Width)
- 3- Lining: 01000 0/10-118
- 4- 120" wide headrail and 92" overall length
- 5- 6 panels
- 6- Split Draw
- 7- $120" \text{ headrail} / 6 \text{ panels} = 20" + 4" \text{ overlap} = 24" \text{ wide panels}$
- 8- Series 26 (found in Fabric Pricing Guide). Go to the section for wide-width fabrics and look at the chart for lined Panel Glides on page 102. Go down the left side to series 26 and across to 24" = retail price of \$207 per panel. Multiply by 6 for the number of panels = \$1242 (Estimated) panel total
- 9- A split draw with 6 panels requires one 4-channel track. A 120" 4-channel track is \$435.
\$1242 total panel price + \$435 for hardware = \$1677 (Estimated) Total
- 10- Ceiling mount
- 11- Control: cord right

(See the suggested track configurations on pages 32 and 33)

PANEL GLIDE COMPLETE HARDWARE PRICING									
UP TO:	36"	48"	60"	72"	96"	120"	144"	168"	192"
2 Channel	125	152	180	209	265	320	370	430	485
3 Channel	135	169	203	236	304	371	439	506	574
4 Channel	151	192	232	273	354	435	516	597	678
5 Channel	167	213	259	305	397	489	581	672	764

PANEL GLIDE COMPLETE SUGGESTED TRACK CONFIGURATIONS

SPLIT DRAW

Total Panels Needed: 2 | Total Tracks and Channels Required: One 2-Channel Track | Mounting Depth Required: 1 1/2"



Total Panels Needed: 4 | Total Tracks and Channels Required: One 3-Channel Track | Mounting Depth Required: 2"



Total Panels Needed: 6 | Total Tracks and Channels Required: One 4-Channel Track | Mounting Depth Required: 2 5/8"



Total Panels Needed: 8 | Total Tracks and Channels Required: One 5-Channel Track | Mounting Depth Required: 3 3/8"



Total Panels Needed: 10 | Total Tracks and Channels Required: Two 3-Channel Tracks | Mounting Depth Required: 4 1/8"

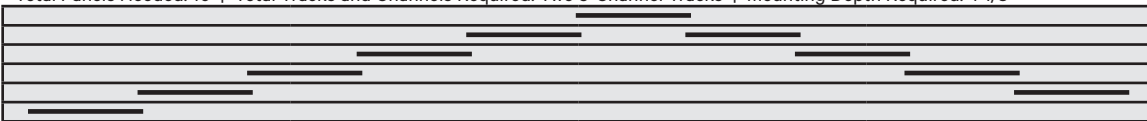

Total Panels Needed: 12 | Total Tracks and Channels Required: One 3-Channel Track & One 4-Channel Track | Mounting Depth Required: 4 3/4"



Total Panels Needed: 14 | Total Tracks and Channels Required: Two 4-Channel Tracks | Mounting Depth Required: 5 3/4"



Total Panels Needed: 16 | Total Tracks and Channels Required: One 4-Channel Track & One 5-Channel Track | Mounting Depth Required: 6 1/4"

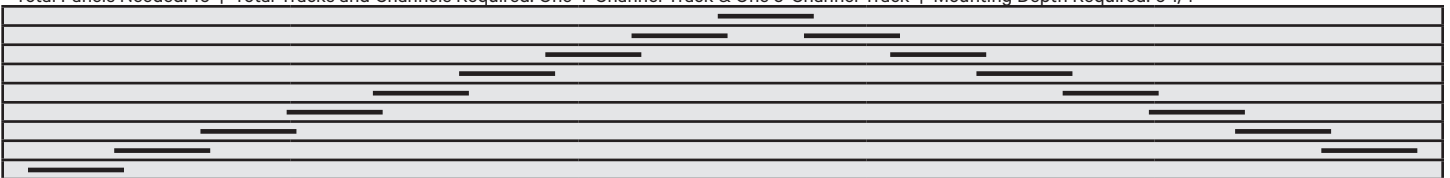

Total Panels Needed: 18 | Total Tracks and Channels Required: Two 5-Channel Tracks | Mounting Depth Required: 6 7/8"

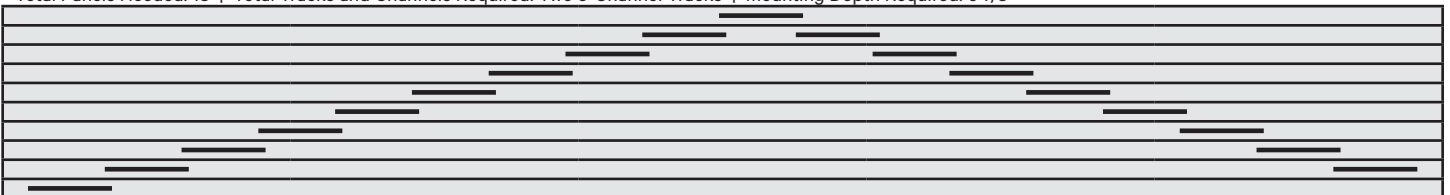

NOTE:

- Your order must indicate whether you want a one-way or split draw.
- For a split draw, the front left AND front right panel will be stationary unless otherwise specified.

PANEL GLIDE COMPLETE SUGGESTED TRACK CONFIGURATIONS

ONE-WAY DRAW (LEFT STACK SHOWN)

Total Panels Needed: 2 | Total Tracks and Channels Required: One 2-Channel Track | Mounting Depth Required: 1 1/2"



Total Panels Needed: 3 | Total Tracks and Channels Required: One 3-Channel Track | Mounting Depth Required: 2"

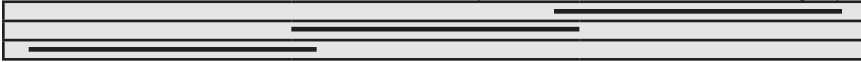

Total Panels Needed: 4 | Total Tracks and Channels Required: One 4-Channel Track | Mounting Depth Required: 2 5/8"



Total Panels Needed: 5 | Total Tracks and Channels Required: One 5-Channel Track | Mounting Depth Required: 3 3/8"

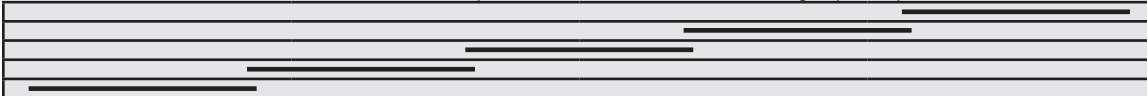

Total Panels Needed: 6 | Total Tracks and Channels Required: Two 3-Channel Tracks | Mounting Depth Required: 4 1/8"

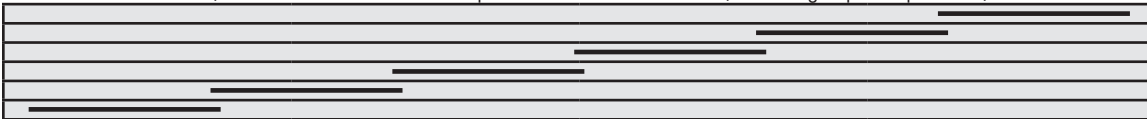

Total Panels Needed: 7 | Total Tracks and Channels Required: One 3-Channel Track & One 4-Channel Track | Mounting Depth Required: 4 3/4"



Total Panels Needed: 8 | Total Tracks and Channels Required: Two 4-Channel Tracks | Mounting Depth Required: 5 3/4"

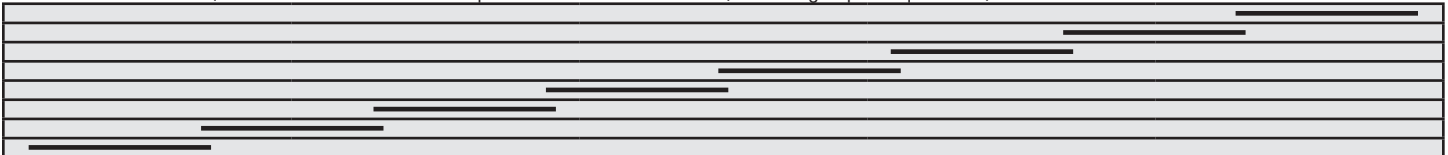

Total Panels Needed: 9 | Total Tracks and Channels Required: One 4-Channel Track & One 5-Channel Track | Mounting Depth Required: 6 1/4"

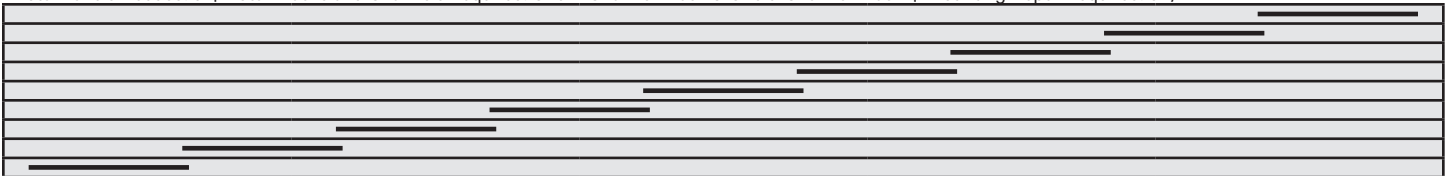

Total Panels Needed: 10 | Total Tracks and Channels Required: Two 5-Channel Tracks | Mounting Depth Required: 6 7/8"

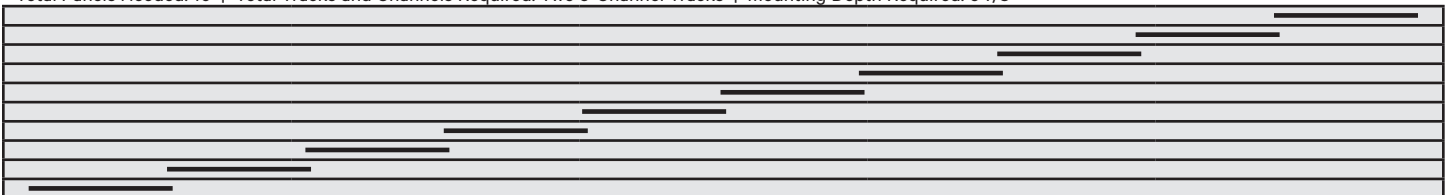

NOTE:

- Your order must indicate whether you want a one-way or split draw.
- For a left stack, the front left panel will be stationary unless otherwise specified.
- For a right stack, the front right panel will be stationary unless otherwise specified.

MOTORIZED PANEL GLIDE SYSTEMS

- The intelligent, built-in motor is self-learning, easy to program and offers aesthetic design integration.
- Motorization is compatible with home automation.
- The motorized system works on radio frequency that allows for wireless programming and operation from a distance.
- All motorized systems have a 12' long cord that plugs into the motor and a transformer on the other end that plugs into the wall.
- The intelligent motor automatically detects its power source for optimized energy efficiency.
- No extra modules are required for installation.
- **The minimum mounting depth required for an inside mount varies depending upon the number of channels.**
- **The maximum width of 19' is dependent upon the overall weight of the system—heavier fabrics may have a lower max width**
- The motor can only mount on the left side of the track.
- Each multi-channel remote can be paired to multiple systems and even different styles. With a single touch, you can operate every system in your home as long as each consecutive system is within 98' of the previous one.

MOTORIZED PANEL GLIDE SYSTEM SPECIFICATIONS

Maximum Width:	19'
Maximum Weight:	33 lbs.
Width of Motor:	8 ¹⁵ / ₁₆ "
Height of Motor:	1 ³ / ₈ "
Motor Depth	
Three Channels:	3 ¹ / ₄ "
Four Channels:	3 ¹⁵ / ₁₆ "
Five Channels:	4 ⁵ / ₈ "
Space Required for Inside Mount (IB)	
Two Channels not available with motorization	
Three Channels:	4 ¹ / ₄ "
Four Channels:	4 ¹ / ₄ "
Five Channels:	4 ¹⁵ / ₁₆ "



Widths and lengths larger than 105" will be shipped LTL with additional charges. (See page 249 of this guide for shipping charges).

ORDERING MOTORIZED PANEL GLIDE SYSTEM

Simply add the surcharge (below) to the price for your complete panel glide system.

MOTORIZED PANEL GLIDE SYSTEM SURCHARGE				
	Power	Package Description	Properties	Retail Price
Motorized Panel Glide	Transformer	DC motor, with wall plug transformer Multi-channel remote in Pearl White	Transformer comes with 12' long cable 32' extension cable available	\$600

Motor is built into the back of the headrail, and always on the left side, regardless of the stack.

FABRIC SHADES

- Available in 11 popular shade styles that can all be lined—with the exception of the **Austrian, which is always unlined.**
 - Roman shades fold up when raised, resulting in a decorative stack of folds on the bottom of the raised shade.
 - **Available in board mount or headrail mount**
 - **Weight limit for headrail mount shades: 13 pounds for manual operation and 9 ½ pounds for motorized shades.**
 - Depending on the dimensions of the shade and the weight of the selected fabric, a board mount might be required.**
 - For side-by-side shades that are ordered at the same time in the identical style, fabric, color, lining, height, lift system and mounting style, the fold alignment tolerance is guaranteed to be within ¼". (The order **MUST** indicate that the shades are to hang side-by-side.)
 - **Small needle holes may be visible through stitched areas on select shades—particularly where the pockets and rings are sewn. This is most noticeable with room-darkening lining. This is NOT a manufacturing defect and no credit will be issued.** flair21's flat and back slat shade styles feature a unique fabrication technique eliminating any stitch hole concerns.
- NOTE:** If you select a shade style with a shaped bottom, you can choose the length to be measured to the bottom of the scallop or to the bottom of the weight bar. You can also elect to have the shade straight on the bottom when the shade is in the closed position. In this case, the shape will reveal itself when the shade is raised.

FABRIC SHADE FEATURES

CHILD-SAFETY

- flair21 fabricates shades in compliance with the ANSI (American National Standards Institute) child safety regulations.
- Our clear, UV-stable rings and ring locks prevent dangerous cord loops. (Depending on the style, rings are sewn approx. 5", 6" or 7" apart.)
- The manually-operated control cord (bead chain) features a child-safe clutch system and wall-mounted tension device.

MOTORIZED OPERATION

- The ultimate in functionality and convenience.
- Control multiple shades with a single remote or integrate into an existing home automation system.

QUICK TURN AROUND

- Get custom shades in as little as 15 business days for in-stock fabrics.

EASILY ADJUSTABLE

- flair21 utilizes a unique cord adjuster orb, so you can easily level and adjust the overall height of your shades.

BLACKOUT

- In addition to using a true blackout lining (not dim out), our unique fabrication technique (on Flat and Back Slat Roman Shades) eliminates all pinholes for a more effective room-darkening shade.

MINIMAL DRESSING

flair21 shades are crafted to fall into a symmetrical stack with minimal to no dressing required (depending on shade style and fabric selection).

EXTENSIVE SELECTION

- Available in 11 different styles and over 225 high quality fabrics—all hand crafted to your exact specifications.

MANUAL BOARD MOUNT FABRIC SHADE

- Board mount shades are stapled to wood, referred to as a dust board.
 - Each dust board is covered with the same face fabric as the shade.
 - flair21 uses a 2" wide dust board, giving you a 2" return. (A 5 ½" dust board is available upon request.)
 - NOTE: Board Mount Fabric Shades with motorization require a 3 ½" board with a projection of 3 ½".**
- flair21 uses the child-safe RollEase® clutch system for board mounted shades with manual control.
 - This system requires 2" of space, and therefore, the return cannot be smaller than 2".**
- **The minimum width for a functioning board mounted shade is 24".**
- All of the hardware required for installation is provided with every order.

STANDARD FRONT MOUNT

- The shade mounts on the front edge of the dust board.
- The hardware is mounted on the bottom of the dust board, behind the shade.
- The beaded chain control cord is behind the shade so that it is not visible from the front of the shade.

MANUAL BOARD MOUNT FABRIC SHADE SPECIFICATIONS

Maximum Width:	108"
Minimum Width:	24"
Maximum Length:	144"
Minimum Length:	27 ⅝"
Space Required for Inside Mount (IB):	2"
Maximum Weight:	30 lbs.

Widths and lengths larger than 105" will be shipped LTL with additional charges. (See page 249 of this guide for shipping charges).

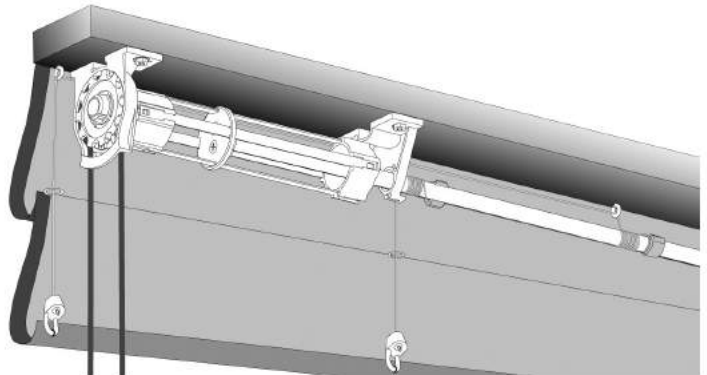

HOW TO MEASURE FOR FABRIC SHADES

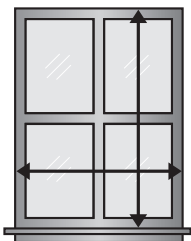

INSIDE MOUNT

- Measure the inside width of the window frame in three places: top, middle, and bottom. Then, measure the length in three places: both sides and the center. Use the smallest measurements.
- **flair21 will take ¼" deduction off the width for an inside mount shade.**

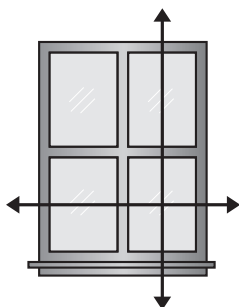

OUTSIDE MOUNT

- Measure the width and length you wish to cover (NOTE: This is typically 2"– 4" from the outside edge of the window—from the top of the headrail, to the bottom of the fabric).
- **flair21 DOES NOT make any deductions or additions.**

MOTORIZED BOARD MOUNT FABRIC SHADE

- Easy and efficient installation, programming and operation.
- The intelligent, built-in motor is self-learning, easy to program and offers aesthetic design integration.
- Motorization is compatible with home automation.
- The motorized system works on radio frequency that allows for wireless programming and operation from a distance.
- Board Mount Fabric Shades are only available with a wall plug.
- The intelligent motor automatically detects its power source for optimized energy efficiency.
- Motorized Board Mount Fabric Shades require a 3 1/2" board with a projection of 3 1/2".
- No extra modules are required for installation.
- No control cords.
- The motor is hidden inside the tube, which is mounted under the board.
- Each multi-channel remote can be paired to multiple systems and even different styles. With a single touch, you can operate every system in your home as long as each consecutive system is within 98' of the previous one.

MOTORIZED BOARD MOUNT FABRIC SHADE SPECIFICATIONS

Maximum Width:	141"
Minimum Width:	30"
Maximum Length:	137"
Width of Motor:	8 15/16"
Space Required for Inside Mount (IB):	3 1/2"
Maximum Weight:	41 lbs.



Widths and lengths larger than 105" will be shipped LTL with additional charges. (See page 249 of this guide for shipping charges).

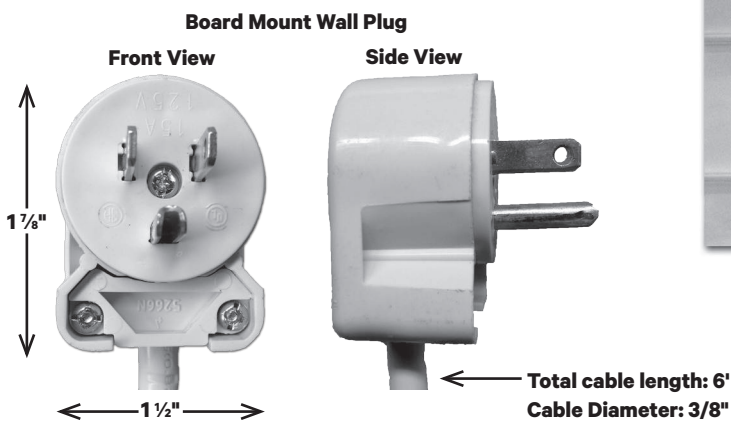

MOTORIZED BOARD MOUNT FABRIC SHADE SURCHARGE				
	Power	Package Description	Properties	Retail Price
Motorized Board Mount	Plug/Direct Connection	Tubular motor with built-in wall plug Multi-channel remote in Pearl White	Shade stapled to a 3 1/2" wood dust board Tubular motor will be mounted under board	\$800

Motor is built into the tube (for board mount).

ORDERING BOARD MOUNT FABRIC SHADES

- 1- Determine quantity.
- 2- Select fabrication style (e.g. Back Slat Roman Shade).
- 3- Select a fabric design and color for your fabric shade. (Make sure your selection is suitable for fabric shades. See the Recommended Applications at flair21.com.)
- 4- Specify the width and length of the shade (The length of the shade can vary depending on the style and where you want the bottom of the shade to hang. Refer to 'shade bottom' and 'length measured to' on the order form to determine the finished length.)
- 5- Determine whether the shade will be lined or unlined (**all Décor 54 shades are recommended lined only**), and select the design and color.
- 6- Indicate if interlining is desired. **NOTE: Interlining is recommended for select silks and faux silks** (see the Properties and Recommended Applications at flair21.com).
- 7- For a quick estimate: identify the fabric series number at flair21.com or in the appropriate Fabric Pricing Guide. Then, in this Chart Pricing Guide, find the section matching your fabric width (wide- or narrow-width), fabrication, and lining selections. Find the page with the chart for the series number you found, and find the price based on your width and length.
- 8- Specify control position: left or right.
- 9- Specify the mount and bracket: board mount with fabric cover or headrail mount with Velcro[®]; inside or outside brackets.
- 10- Specify any upgrades: you can order a 6" fabric valance for the front of your shade. The valance fabric can be the same fabric as the shade or out of a coordinating/contrasting fabric. You can also order a 6" back-mounted valance for the back edge of the dust board at no charge. This valance is made out of the same fabric as the lining of the shade. The purpose of this valance is to hide the hardware from the outside of the window.
- 11- *For motorization: add the surcharge to the shade price found in the charts.

PRICE EXAMPLE: MANUAL BOARD MOUNT FABRIC SHADE

- 1- Quantity = 1
- 2- Back Slat Roman Shade
- 3- Fabric: 1202 0/682-59 (Narrow-Width)
- 4- 48" x 60"
- 5- Lining: 01000 0/10-118
- 6- No Interlining
- 7- Series 11 (found in Fabric Pricing Guide). Go to page 239 for Back Slat Lined Roman Shades using narrow-width fabric. Look at the chart for series 11, go down the left side to 60" and across to 48" = retail price of \$602 (Estimated) Total.
- 8- Control: left
- 9- Mount: board mount and outside brackets
- 10- No upgrades
- 11- Manual operation chosen

MANUAL HEADRAIL MOUNT FABRIC SHADE

- A new roman shade system, which uses a modern, slim, metal headrail design with Velcro®.
- The shade is attached to the front of the headrail using Velcro®, and can easily be detached and reattached for convenient cleaning.
- The headrail has a built-in, child-safe clutch system with quiet and efficient operation.
- Brackets with slim installation clips (and all other hardware required for installation) are provided with every order.
- **There is a strict weight limit of 13 pounds for manual operation headrail mount shades and 9 ½ pounds for motorized shades.**
 —Depending on the dimensions of the shade and the weight of the selected fabric, a board mount might be required.
- Installing Inside Mount (IB):
 —Minimum depth for IB flush mount: 1 ½"
 —Minimum depth for IB mount, not flush with the opening: 5/8"
- The minimum width for a functioning headrail-mounted shade with manual operation is 13".

MANUAL HEADRAIL MOUNT FABRIC SHADE SPECIFICATIONS

Headrail	
Depth:	1 ½"
Height:	1 3/8"
Maximum Width (Wide-Width Fabrics):	141"
Maximum Width (Narrow-Width Fabrics):	112"
Minimum Width:	13"
Maximum Length:	137"
Minimum Length:	22 5/8"
Maximum Weight:	13 lbs.
Space Range for Inside Mount (IB):	5/8"–1 ½"

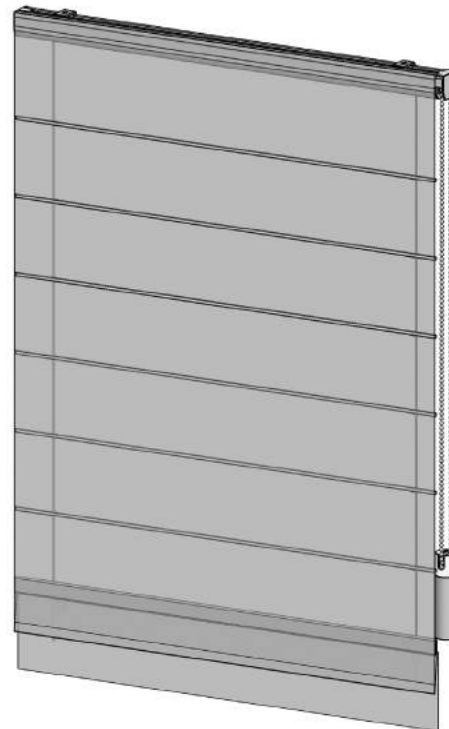

***Specific limitations apply for individual shade styles and lining selection. (See note above each pricing chart).**

Widths and lengths larger than 105" will be shipped LTL with additional charges. (See page 249 of this guide for shipping charges).



Lift Cord Spool

MOTORIZED HEADRAIL MOUNT FABRIC SHADE

- Easy and efficient installation, programming and operation.
- The intelligent, built-in motor is self-learning, easy to program and offers aesthetic design integration.
- Motorization is compatible with home automation.
- The motorized system works on radio frequency that allows for wireless programming and operation from a distance.
- All motorized systems have a 12' long cord that plugs into the motor and a transformer on the other end that plugs into the wall.
- The intelligent motor automatically detects its power source for optimized energy efficiency.
- No extra modules are required for installation.
- No control cords.
- The motor is hidden inside the headrail.
- Each multi-channel remote can be paired to multiple systems and even different styles. With a single touch, you can operate every system in your home as long as each consecutive system is within 98' of the previous one.

MOTORIZED HEADRAIL MOUNT FABRIC SHADE SPECIFICATIONS

Headrail	
Depth:	1 ½"
Height:	1 ⅜"
Maximum Width (Wide-Width Fabrics):	111"
Maximum Width (Narrow-Width Fabrics):	77"
Minimum Width:	24 ¼"
Maximum Length:	137"
Maximum Weight:	9 ½ lbs.
Space Range for Inside Mount (IB):	5/8"-1 ½"

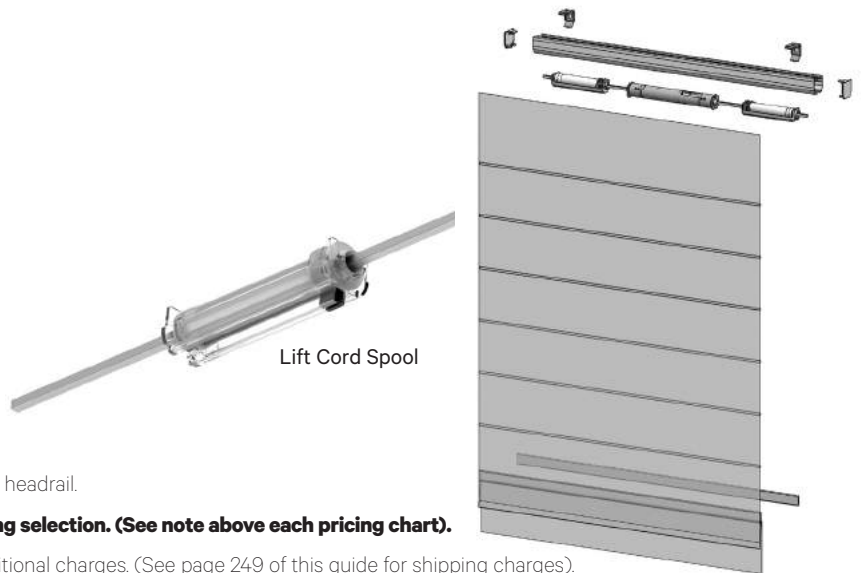

No additional space is required for the motor since it is inside the headrail.

***Specific limitations apply for individual shade styles and lining selection. (See note above each pricing chart).**

Widths and lengths larger than 105" will be shipped LTL with additional charges. (See page 249 of this guide for shipping charges).

MOTORIZED HEADRAIL MOUNT FABRIC SHADE SURCHARGE				
	Power	Package Description	Properties	Retail Price
Motorized Headrail Mount	Transformer	Middle motor with wall plug transformer Multi-channel remote in Pearl White	Shade attached with Velcro to metal headrail Middle motor is mounted inside headrail	\$600

ORDERING HEADRAIL MOUNT FABRIC SHADES

- 1- Determine quantity.
- 2- Select fabrication style (e.g. Flat Roman Shade).
- 3- Select a fabric design and color for your fabric shade. (Make sure your selection is suitable for fabric shades. See the Recommended Applications at flair21.com.)
- 4- Specify the width and length of the shade (The length of the shade can vary depending on the style and where you want the bottom of the shade to hang. Refer to 'shade bottom' and 'length measured to' on the order form to determine the finished length.)
- 5- Determine whether the shade will be lined or unlined (**all Décor 54 shades are recommended lined only**), and select the design and color.
- 6- Indicate if interlining is desired. **NOTE: Interlining is recommended for select silks and faux silks** (see the Properties and Recommended Applications at flair21.com).
- 7- For a quick estimate: identify the fabric series number at flair21.com or in the appropriate Fabric Pricing Guide. Then, in this Chart Pricing Guide, find the section with your fabric width (wide- or narrow-width), fabrication, and lining selections. Look at the chart for the series number you found, and find the price based on your width/length.
- 8- Specify control position: left or right.
- 9- Specify the mount and bracket: board mount with fabric cover or headrail mount with Velcro®; inside or outside brackets
- 10- Specify any upgrades: you can order a 6" fabric valance for the front of your shade. The valance fabric can be the same fabric as the shade or out of a contrasting or coordinating fabric. You can also order a 6" back-mounted valance for the back edge of the dust board. This valance is made out of the same fabric as the lining of the shade. The purpose of this valance is to hide the controls from the outside of the window.
- 11- *For motorization: add the surcharge to the shade price found in the charts.

PRICE EXAMPLE: MOTORIZED HEADRAIL MOUNT FABRIC SHADE

- 1- Quantity = 1
- 2- Flat Roman Shade
- 3- Fabric: 00114 1/10-112 (Wide-Width)
- 4- 48" x 60"
- 5- No Lining
- 6- No Interlining
- 7- Series 26 (found in Fabric Pricing Guide). Go to page 108 for Flat Unlined Roman Shades using wide-width fabric. Look at the chart for series 26, go down the left side to 60" and across to 48" = \$563 (Estimated) Total.
- 8- Control: *no control with motorization
- 9- Mount: headrail mount with Velcro® and outside brackets
- 10- Motorization upgrade chosen
- 11- \$563 (Shade) + \$600 (Motorization) = \$1163 (Estimated) Total

WIDE-WIDTH FABRIC (102" – 130")

PRICING CHARTS

NOTE: Our price charts make it easy to estimate the price of your window treatment based on standard widths and lengths. If your measurements fall in-between two sizes, your actual price (stated on the order confirmation) will be based on the EXACT width and length of your order.

Pricing Charts do NOT reflect the additional yardage that may be required for pattern matching.

Shipping charges will be added at a \$20 flat-rate per order, with the exception of oversized/overweight shipments requiring LTL (see page 249 in this guide for additional information).

PLEATED DRAPERIES: 2.5 Fullness — Unlined

Maximum length 109" with Eurohem (exceptions may apply). Sizes and series numbers beyond what is listed in the charts below are available—please submit these quote requests via fax or email.

Series		Finished Pair or Panel Width									
		36"	48"	60"	72"	84"	96"	108"	120"	132"	144"
07	Eurohem	161	214	257	310	364	407	460	513	556	610
08	Eurohem	176	234	279	338	396	442	500	558	604	662
09	Eurohem	188	250	297	360	422	470	532	594	642	704
10	Eurohem	200	266	315	382	448	498	564	630	680	746
11	Eurohem	212	282	333	404	474	526	596	666	718	788
12	Eurohem	224	298	351	426	500	554	628	702	756	830
13	Eurohem	236	314	369	448	526	582	660	738	794	872
14	Eurohem	248	330	387	470	552	610	692	774	832	914
15	Eurohem	260	346	405	492	578	638	724	810	870	956
16	Eurohem	272	362	423	514	604	666	756	846	908	998
17	Eurohem	284	378	441	536	630	694	788	882	946	1,040
18	Eurohem	296	394	459	558	656	722	820	918	984	1,082
19	Eurohem	308	410	477	580	682	750	852	954	1,022	1,124
20	Eurohem	320	426	495	602	708	778	884	990	1,060	1,166
21	Eurohem	332	442	513	624	734	806	916	1,026	1,098	1,208
22	Eurohem	344	458	531	646	760	834	948	1,062	1,136	1,250
23	Eurohem	356	474	549	668	786	862	980	1,098	1,174	1,292
24	Eurohem	368	490	567	690	812	890	1,012	1,134	1,212	1,334
25	Eurohem	386	514	594	723	851	932	1,060	1,188	1,269	1,397
26	Eurohem	398	530	612	745	877	960	1,092	1,224	1,307	1,439
27	Eurohem	410	546	630	767	903	988	1,124	1,260	1,345	1,481
28	Eurohem	422	562	648	789	929	1,016	1,156	1,296	1,383	1,523
29	Eurohem	434	578	666	811	955	1,044	1,188	1,332	1,421	1,565
30	Eurohem	452	602	693	844	994	1,086	1,236	1,386	1,478	1,628
31	Eurohem	461	614	707	860	1,014	1,107	1,260	1,413	1,506	1,660
32	Eurohem	473	630	725	882	1,040	1,135	1,292	1,449	1,544	1,702
33	Eurohem	488	650	747	910	1,072	1,170	1,332	1,494	1,592	1,754
34	Eurohem	518	690	792	965	1,137	1,240	1,412	1,584	1,687	1,859
35	Eurohem	548	730	837	1,020	1,202	1,310	1,492	1,674	1,782	1,964
36	Eurohem	584	778	891	1,086	1,280	1,394	1,588	1,782	1,896	2,090

Maximum length 101" with 4" hem (exceptions may apply).

Series		Finished Pair or Panel Width									
		36"	48"	60"	72"	84"	96"	108"	120"	132"	144"
07	Hemmed	166	221	266	321	376	421	476	531	576	631
08	Hemmed	181	241	288	349	409	456	516	576	624	684
09	Hemmed	193	257	306	371	435	484	548	612	662	726
10	Hemmed	205	273	324	393	461	512	580	648	700	768
11	Hemmed	217	289	342	415	487	540	612	684	738	810
12	Hemmed	229	305	360	437	513	568	644	720	776	852
13	Hemmed	241	321	378	459	539	596	676	756	814	894
14	Hemmed	253	337	396	481	565	624	708	792	852	936
15	Hemmed	265	353	414	503	591	652	740	828	890	978
16	Hemmed	277	369	432	525	617	680	772	864	928	1,020
17	Hemmed	289	385	450	547	643	708	804	900	966	1,062
18	Hemmed	301	401	468	569	669	736	836	936	1,004	1,104
19	Hemmed	313	417	486	591	695	764	868	972	1,042	1,146
20	Hemmed	325	433	504	613	721	792	900	1,008	1,080	1,188
21	Hemmed	337	449	522	635	747	820	932	1,044	1,118	1,230
22	Hemmed	349	465	540	657	773	848	964	1,080	1,156	1,272
23	Hemmed	361	481	558	679	799	876	996	1,116	1,194	1,314
24	Hemmed	373	497	576	701	825	904	1,028	1,152	1,232	1,356
25	Hemmed	391	521	603	734	864	946	1,076	1,206	1,289	1,419
26	Hemmed	403	537	621	756	890	974	1,108	1,242	1,327	1,461
27	Hemmed	415	553	639	778	916	1,002	1,140	1,278	1,365	1,503
28	Hemmed	427	569	657	800	942	1,030	1,172	1,314	1,403	1,545
29	Hemmed	439	585	675	822	968	1,058	1,204	1,350	1,441	1,587
30	Hemmed	457	609	702	855	1,007	1,100	1,252	1,404	1,498	1,650
31	Hemmed	466	621	716	871	1,026	1,121	1,276	1,431	1,526	1,681
32	Hemmed	478	637	734	893	1,052	1,149	1,308	1,467	1,564	1,723
33	Hemmed	493	657	756	921	1,085	1,184	1,348	1,512	1,612	1,776
34	Hemmed	523	697	801	976	1,150	1,254	1,428	1,602	1,707	1,881
35	Hemmed	553	737	846	1,031	1,215	1,324	1,508	1,692	1,802	1,986
36	Hemmed	589	785	900	1,097	1,293	1,408	1,604	1,800	1,916	2,112

PLEATED DRAPERIES: 2.5 Fullness — Lined (Lining 01000)

Maximum length 109" with Eurohem (exceptions may apply). Sizes and series numbers beyond what is listed in the charts below are available—please submit these quote requests via fax or email.

Series		Finished Pair or Panel Width									
		36"	48"	60"	72"	84"	96"	108"	120"	132"	144"
07	Eurohem	264	351	414	502	589	652	740	827	890	978
08	Eurohem	279	371	436	529	622	687	780	872	937	1,030
09	Eurohem	291	387	454	551	648	715	812	908	975	1,072
10	Eurohem	303	403	472	573	674	743	844	944	1,013	1,114
11	Eurohem	315	419	490	595	700	771	876	980	1,051	1,156
12	Eurohem	327	435	508	617	726	799	908	1,016	1,089	1,198
13	Eurohem	339	451	526	639	752	827	940	1,052	1,127	1,240
14	Eurohem	351	467	544	661	778	855	972	1,088	1,165	1,282
15	Eurohem	363	483	562	683	804	883	1,004	1,124	1,203	1,324
16	Eurohem	375	499	580	705	830	911	1,036	1,160	1,241	1,366
17	Eurohem	387	515	598	727	856	939	1,068	1,196	1,279	1,408
18	Eurohem	399	531	616	749	882	967	1,100	1,232	1,317	1,450
19	Eurohem	411	547	634	771	908	995	1,132	1,268	1,355	1,492
20	Eurohem	423	563	652	793	934	1,023	1,164	1,304	1,393	1,534
21	Eurohem	435	579	670	815	960	1,051	1,196	1,340	1,431	1,576
22	Eurohem	447	595	688	837	986	1,079	1,228	1,376	1,469	1,618
23	Eurohem	459	611	706	859	1,012	1,107	1,260	1,412	1,507	1,660
24	Eurohem	471	627	724	881	1,038	1,135	1,292	1,448	1,545	1,702
25	Eurohem	489	651	751	914	1,077	1,177	1,340	1,502	1,602	1,765
26	Eurohem	501	667	769	936	1,103	1,205	1,372	1,538	1,640	1,807
27	Eurohem	513	683	787	958	1,129	1,233	1,404	1,574	1,678	1,849
28	Eurohem	525	699	805	980	1,155	1,261	1,436	1,610	1,716	1,891
29	Eurohem	537	715	823	1,002	1,181	1,289	1,468	1,646	1,754	1,933
30	Eurohem	555	739	850	1,035	1,220	1,331	1,516	1,700	1,811	1,996
31	Eurohem	564	751	864	1,052	1,239	1,352	1,540	1,727	1,840	2,028
32	Eurohem	576	767	882	1,074	1,265	1,380	1,572	1,763	1,878	2,070
33	Eurohem	591	787	904	1,101	1,298	1,415	1,612	1,808	1,925	2,122
34	Eurohem	621	827	949	1,156	1,363	1,485	1,692	1,898	2,020	2,227
35	Eurohem	651	867	994	1,211	1,428	1,555	1,772	1,988	2,115	2,332
36	Eurohem	687	915	1,048	1,277	1,506	1,639	1,868	2,096	2,229	2,458

Maximum length 101" with 4" hem (exceptions may apply).

Series		Finished Pair or Panel Width									
		36"	48"	60"	72"	84"	96"	108"	120"	132"	144"
07	Hemmed	284	379	448	543	637	707	801	896	965	1,060
08	Hemmed	299	399	471	570	670	742	841	941	1,013	1,112
09	Hemmed	311	415	489	592	696	770	873	977	1,051	1,154
10	Hemmed	323	431	507	614	722	798	905	1,013	1,089	1,196
11	Hemmed	335	447	525	636	748	826	937	1,049	1,127	1,238
12	Hemmed	347	463	543	658	774	854	969	1,085	1,165	1,280
13	Hemmed	359	479	561	680	800	882	1,001	1,121	1,203	1,322
14	Hemmed	371	495	579	702	826	910	1,033	1,157	1,241	1,364
15	Hemmed	383	511	597	724	852	938	1,065	1,193	1,279	1,406
16	Hemmed	395	527	615	746	878	966	1,097	1,229	1,317	1,448
17	Hemmed	407	543	633	768	904	994	1,129	1,265	1,355	1,490
18	Hemmed	419	559	651	790	930	1,022	1,161	1,301	1,393	1,532
19	Hemmed	431	575	669	812	956	1,050	1,193	1,337	1,431	1,574
20	Hemmed	443	591	687	834	982	1,078	1,225	1,373	1,469	1,616
21	Hemmed	455	607	705	856	1,008	1,106	1,257	1,409	1,507	1,658
22	Hemmed	467	623	723	878	1,034	1,134	1,289	1,445	1,545	1,700
23	Hemmed	479	639	741	900	1,060	1,162	1,321	1,481	1,583	1,742
24	Hemmed	491	655	759	922	1,086	1,190	1,353	1,517	1,621	1,784
25	Hemmed	509	679	786	955	1,125	1,232	1,401	1,571	1,678	1,847
26	Hemmed	521	695	804	977	1,151	1,260	1,433	1,607	1,716	1,889
27	Hemmed	533	711	822	999	1,177	1,288	1,465	1,643	1,754	1,931
28	Hemmed	545	727	840	1,021	1,203	1,316	1,497	1,679	1,792	1,973
29	Hemmed	557	743	858	1,043	1,229	1,344	1,529	1,715	1,830	2,015
30	Hemmed	575	767	885	1,076	1,268	1,386	1,577	1,769	1,887	2,078
31	Hemmed	584	779	898	1,093	1,287	1,407	1,601	1,796	1,915	2,110
32	Hemmed	596	795	916	1,115	1,313	1,435	1,633	1,832	1,953	2,152
33	Hemmed	611	815	939	1,142	1,346	1,470	1,673	1,877	2,001	2,204
34	Hemmed	641	855	984	1,197	1,411	1,540	1,753	1,967	2,096	2,309
35	Hemmed	671	895	1,029	1,252	1,476	1,610	1,833	2,057	2,191	2,414
36	Hemmed	707	943	1,083	1,318	1,554	1,694	1,929	2,165	2,305	2,540

PLEATED DRAPERIES: 3 Fullness — Unlined

Maximum length 109" with Eurohem (exceptions may apply). Sizes and series numbers beyond what is listed in the charts below are available—please submit these quote requests via fax or email.

Series		Finished Pair or Panel Width									
		36"	48"	60"	72"	84"	96"	108"	120"	132"	144"
07	Eurohem	171	225	278	331	385	438	492	545	598	652
08	Eurohem	189	247	305	364	422	481	539	597	656	714
09	Eurohem	203	265	327	390	452	515	577	639	702	764
10	Eurohem	217	283	349	416	482	549	615	681	748	814
11	Eurohem	231	301	371	442	512	583	653	723	794	864
12	Eurohem	245	319	393	468	542	617	691	765	840	914
13	Eurohem	259	337	415	494	572	651	729	807	886	964
14	Eurohem	273	355	437	520	602	685	767	849	932	1,014
15	Eurohem	287	373	459	546	632	719	805	891	978	1,064
16	Eurohem	301	391	481	572	662	753	843	933	1,024	1,114
17	Eurohem	315	409	503	598	692	787	881	975	1,070	1,164
18	Eurohem	329	427	525	624	722	821	919	1,017	1,116	1,214
19	Eurohem	343	445	547	650	752	855	957	1,059	1,162	1,264
20	Eurohem	357	463	569	676	782	889	995	1,101	1,208	1,314
21	Eurohem	371	481	591	702	812	923	1,033	1,143	1,254	1,364
22	Eurohem	385	499	613	728	842	957	1,071	1,185	1,300	1,414
23	Eurohem	399	517	635	754	872	991	1,109	1,227	1,346	1,464
24	Eurohem	413	535	657	780	902	1,025	1,147	1,269	1,392	1,514
25	Eurohem	434	562	690	819	947	1,076	1,204	1,332	1,461	1,589
26	Eurohem	448	580	712	845	977	1,110	1,242	1,374	1,507	1,639
27	Eurohem	462	598	734	871	1,007	1,144	1,280	1,416	1,553	1,689
28	Eurohem	476	616	756	897	1,037	1,178	1,318	1,458	1,599	1,739
29	Eurohem	490	634	778	923	1,067	1,212	1,356	1,500	1,645	1,789
30	Eurohem	511	661	811	962	1,112	1,263	1,413	1,563	1,714	1,864
31	Eurohem	521	675	828	981	1,135	1,288	1,442	1,595	1,748	1,902
32	Eurohem	535	693	850	1,007	1,165	1,322	1,480	1,637	1,794	1,952
33	Eurohem	553	715	877	1,040	1,202	1,365	1,527	1,689	1,852	2,014
34	Eurohem	588	760	932	1,105	1,277	1,450	1,622	1,794	1,967	2,139
35	Eurohem	623	805	987	1,170	1,352	1,535	1,717	1,899	2,082	2,264
36	Eurohem	665	859	1,053	1,248	1,442	1,637	1,831	2,025	2,220	2,414

Maximum length 101" with 4" hem (exceptions may apply).

Series		Finished Pair or Panel Width									
		36"	48"	60"	72"	84"	96"	108"	120"	132"	144"
07	Hemmed	177	232	287	342	397	453	508	563	618	673
08	Hemmed	194	254	314	375	435	495	555	615	676	736
09	Hemmed	208	272	336	401	465	529	593	657	722	786
10	Hemmed	222	290	358	427	495	563	631	699	768	836
11	Hemmed	236	308	380	453	525	597	669	741	814	886
12	Hemmed	250	326	402	479	555	631	707	783	860	936
13	Hemmed	264	344	424	505	585	665	745	825	906	986
14	Hemmed	278	362	446	531	615	699	783	867	952	1,036
15	Hemmed	292	380	468	557	645	733	821	909	998	1,086
16	Hemmed	306	398	490	583	675	767	859	951	1,044	1,136
17	Hemmed	320	416	512	609	705	801	897	993	1,090	1,186
18	Hemmed	334	434	534	635	735	835	935	1,035	1,136	1,236
19	Hemmed	348	452	556	661	765	869	973	1,077	1,182	1,286
20	Hemmed	362	470	578	687	795	903	1,011	1,119	1,228	1,336
21	Hemmed	376	488	600	713	825	937	1,049	1,161	1,274	1,386
22	Hemmed	390	506	622	739	855	971	1,087	1,203	1,320	1,436
23	Hemmed	404	524	644	765	885	1,005	1,125	1,245	1,366	1,486
24	Hemmed	418	542	666	791	915	1,039	1,163	1,287	1,412	1,536
25	Hemmed	439	569	699	830	960	1,090	1,220	1,350	1,481	1,611
26	Hemmed	453	587	721	856	990	1,124	1,258	1,392	1,527	1,661
27	Hemmed	467	605	743	882	1,020	1,158	1,296	1,434	1,573	1,711
28	Hemmed	481	623	765	908	1,050	1,192	1,334	1,476	1,619	1,761
29	Hemmed	495	641	787	934	1,080	1,226	1,372	1,518	1,665	1,811
30	Hemmed	516	668	820	973	1,125	1,277	1,429	1,581	1,734	1,886
31	Hemmed	527	682	837	992	1,147	1,303	1,458	1,613	1,768	1,923
32	Hemmed	541	700	859	1,018	1,177	1,337	1,496	1,655	1,814	1,973
33	Hemmed	558	722	886	1,051	1,215	1,379	1,543	1,707	1,872	2,036
34	Hemmed	593	767	941	1,116	1,290	1,464	1,638	1,812	1,987	2,161
35	Hemmed	628	812	996	1,181	1,365	1,549	1,733	1,917	2,102	2,286
36	Hemmed	670	866	1,062	1,259	1,455	1,651	1,847	2,043	2,240	2,436

PLEATED DRAPERIES: 3 Fullness — Lined (Lining 01000)

Maximum length 109" with Eurohem (exceptions may apply). Sizes and series numbers beyond what is listed in the charts below are available—please submit these quote requests via fax or email.

Series		Finished Pair or Panel Width									
		36"	48"	60"	72"	84"	96"	108"	120"	132"	144"
07	Eurohem	289	376	464	552	639	727	815	902	990	1,078
08	Eurohem	306	399	491	584	677	769	862	955	1,047	1,140
09	Eurohem	320	417	513	610	707	803	900	997	1,093	1,190
10	Eurohem	334	435	535	636	737	837	938	1,039	1,139	1,240
11	Eurohem	348	453	557	662	767	871	976	1,081	1,185	1,290
12	Eurohem	362	471	579	688	797	905	1,014	1,123	1,231	1,340
13	Eurohem	376	489	601	714	827	939	1,052	1,165	1,277	1,390
14	Eurohem	390	507	623	740	857	973	1,090	1,207	1,323	1,440
15	Eurohem	404	525	645	766	887	1,007	1,128	1,249	1,369	1,490
16	Eurohem	418	543	667	792	917	1,041	1,166	1,291	1,415	1,540
17	Eurohem	432	561	689	818	947	1,075	1,204	1,333	1,461	1,590
18	Eurohem	446	579	711	844	977	1,109	1,242	1,375	1,507	1,640
19	Eurohem	460	597	733	870	1,007	1,143	1,280	1,417	1,553	1,690
20	Eurohem	474	615	755	896	1,037	1,177	1,318	1,459	1,599	1,740
21	Eurohem	488	633	777	922	1,067	1,211	1,356	1,501	1,645	1,790
22	Eurohem	502	651	799	948	1,097	1,245	1,394	1,543	1,691	1,840
23	Eurohem	516	669	821	974	1,127	1,279	1,432	1,585	1,737	1,890
24	Eurohem	530	687	843	1,000	1,157	1,313	1,470	1,627	1,783	1,940
25	Eurohem	551	714	876	1,039	1,202	1,364	1,527	1,690	1,852	2,015
26	Eurohem	565	732	898	1,065	1,232	1,398	1,565	1,732	1,898	2,065
27	Eurohem	579	750	920	1,091	1,262	1,432	1,603	1,774	1,944	2,115
28	Eurohem	593	768	942	1,117	1,292	1,466	1,641	1,816	1,990	2,165
29	Eurohem	607	786	964	1,143	1,322	1,500	1,679	1,858	2,036	2,215
30	Eurohem	628	813	997	1,182	1,367	1,551	1,736	1,921	2,105	2,290
31	Eurohem	639	826	1,014	1,202	1,389	1,577	1,765	1,952	2,140	2,328
32	Eurohem	653	844	1,036	1,228	1,419	1,611	1,803	1,994	2,186	2,378
33	Eurohem	670	867	1,063	1,260	1,457	1,653	1,850	2,047	2,243	2,440
34	Eurohem	705	912	1,118	1,325	1,532	1,738	1,945	2,152	2,358	2,565
35	Eurohem	740	957	1,173	1,390	1,607	1,823	2,040	2,257	2,473	2,690
36	Eurohem	782	1,011	1,239	1,468	1,697	1,925	2,154	2,383	2,611	2,840

Maximum length 101" with 4" hem (exceptions may apply).

Series		Finished Pair or Panel Width									
		36"	48"	60"	72"	84"	96"	108"	120"	132"	144"
07	Hemmed	309	404	498	593	687	782	876	971	1,065	1,160
08	Hemmed	327	426	526	625	725	824	924	1,023	1,123	1,222
09	Hemmed	341	444	548	651	755	858	962	1,065	1,169	1,272
10	Hemmed	355	462	570	677	785	892	1,000	1,107	1,215	1,322
11	Hemmed	369	480	592	703	815	926	1,038	1,149	1,261	1,372
12	Hemmed	383	498	614	729	845	960	1,076	1,191	1,307	1,422
13	Hemmed	397	516	636	755	875	994	1,114	1,233	1,353	1,472
14	Hemmed	411	534	658	781	905	1,028	1,152	1,275	1,399	1,522
15	Hemmed	425	552	680	807	935	1,062	1,190	1,317	1,445	1,572
16	Hemmed	439	570	702	833	965	1,096	1,228	1,359	1,491	1,622
17	Hemmed	453	588	724	859	995	1,130	1,266	1,401	1,537	1,672
18	Hemmed	467	606	746	885	1,025	1,164	1,304	1,443	1,583	1,722
19	Hemmed	481	624	768	911	1,055	1,198	1,342	1,485	1,629	1,772
20	Hemmed	495	642	790	937	1,085	1,232	1,380	1,527	1,675	1,822
21	Hemmed	509	660	812	963	1,115	1,266	1,418	1,569	1,721	1,872
22	Hemmed	523	678	834	989	1,145	1,300	1,456	1,611	1,767	1,922
23	Hemmed	537	696	856	1,015	1,175	1,334	1,494	1,653	1,813	1,972
24	Hemmed	551	714	878	1,041	1,205	1,368	1,532	1,695	1,859	2,022
25	Hemmed	572	741	911	1,080	1,250	1,419	1,589	1,758	1,928	2,097
26	Hemmed	586	759	933	1,106	1,280	1,453	1,627	1,800	1,974	2,147
27	Hemmed	600	777	955	1,132	1,310	1,487	1,665	1,842	2,020	2,197
28	Hemmed	614	795	977	1,158	1,340	1,521	1,703	1,884	2,066	2,247
29	Hemmed	628	813	999	1,184	1,370	1,555	1,741	1,926	2,112	2,297
30	Hemmed	649	840	1,032	1,223	1,415	1,606	1,798	1,989	2,181	2,372
31	Hemmed	659	854	1,048	1,243	1,437	1,632	1,826	2,021	2,215	2,410
32	Hemmed	673	872	1,070	1,269	1,467	1,666	1,864	2,063	2,261	2,460
33	Hemmed	691	894	1,098	1,301	1,505	1,708	1,912	2,115	2,319	2,522
34	Hemmed	726	939	1,153	1,366	1,580	1,793	2,007	2,220	2,434	2,647
35	Hemmed	761	984	1,208	1,431	1,655	1,878	2,102	2,325	2,549	2,772
36	Hemmed	803	1,038	1,274	1,509	1,745	1,980	2,216	2,451	2,687	2,922

PLEATED DRAPERIES: 4 Fullness — Unlined

Maximum length 109" with Eurohem (exceptions may apply). Sizes and series numbers beyond what is listed in the charts below are available—please submit these quote requests via fax or email.

Series		Finished Pair or Panel Width									
		36"	48"	60"	72"	84"	96"	108"	120"	132"	144"
07	Eurohem	192	256	309	373	437	491	555	618	672	736
08	Eurohem	215	286	344	416	487	546	617	688	747	818
09	Eurohem	233	310	372	450	527	590	667	744	807	884
10	Eurohem	251	334	400	484	567	634	717	800	867	950
11	Eurohem	269	358	428	518	607	678	767	856	927	1,016
12	Eurohem	287	382	456	552	647	722	817	912	987	1,082
13	Eurohem	305	406	484	586	687	766	867	968	1,047	1,148
14	Eurohem	323	430	512	620	727	810	917	1,024	1,107	1,214
15	Eurohem	341	454	540	654	767	854	967	1,080	1,167	1,280
16	Eurohem	359	478	568	688	807	898	1,017	1,136	1,227	1,346
17	Eurohem	377	502	596	722	847	942	1,067	1,192	1,287	1,412
18	Eurohem	395	526	624	756	887	986	1,117	1,248	1,347	1,478
19	Eurohem	413	550	652	790	927	1,030	1,167	1,304	1,407	1,544
20	Eurohem	431	574	680	824	967	1,074	1,217	1,360	1,467	1,610
21	Eurohem	449	598	708	858	1,007	1,118	1,267	1,416	1,527	1,676
22	Eurohem	467	622	736	892	1,047	1,162	1,317	1,472	1,587	1,742
23	Eurohem	485	646	764	926	1,087	1,206	1,367	1,528	1,647	1,808
24	Eurohem	503	670	792	960	1,127	1,250	1,417	1,584	1,707	1,874
25	Eurohem	530	706	834	1,011	1,187	1,316	1,492	1,668	1,797	1,973
26	Eurohem	548	730	862	1,045	1,227	1,360	1,542	1,724	1,857	2,039
27	Eurohem	566	754	890	1,079	1,267	1,404	1,592	1,780	1,917	2,105
28	Eurohem	584	778	918	1,113	1,307	1,448	1,642	1,836	1,977	2,171
29	Eurohem	602	802	946	1,147	1,347	1,492	1,692	1,892	2,037	2,237
30	Eurohem	629	838	988	1,198	1,407	1,558	1,767	1,976	2,127	2,336
31	Eurohem	642	856	1,009	1,223	1,437	1,591	1,805	2,018	2,172	2,386
32	Eurohem	660	880	1,037	1,257	1,477	1,635	1,855	2,074	2,232	2,452
33	Eurohem	683	910	1,072	1,300	1,527	1,690	1,917	2,144	2,307	2,534
34	Eurohem	728	970	1,142	1,385	1,627	1,800	2,042	2,284	2,457	2,699
35	Eurohem	773	1,030	1,212	1,470	1,727	1,910	2,167	2,424	2,607	2,864
36	Eurohem	827	1,102	1,296	1,572	1,847	2,042	2,317	2,592	2,787	3,062

Maximum length 101" with 4" hem (exceptions may apply).

Series		Finished Pair or Panel Width									
		36"	48"	60"	72"	84"	96"	108"	120"	132"	144"
07	Hemmed	198	263	318	384	450	505	571	636	692	757
08	Hemmed	220	293	353	427	500	560	633	706	767	840
09	Hemmed	238	317	381	461	540	604	683	762	827	906
10	Hemmed	256	341	409	495	580	648	733	818	887	972
11	Hemmed	274	365	437	529	620	692	783	874	947	1,038
12	Hemmed	292	389	465	563	660	736	833	930	1,007	1,104
13	Hemmed	310	413	493	597	700	780	883	986	1,067	1,170
14	Hemmed	328	437	521	631	740	824	933	1,042	1,127	1,236
15	Hemmed	346	461	549	665	780	868	983	1,098	1,187	1,302
16	Hemmed	364	485	577	699	820	912	1,033	1,154	1,247	1,368
17	Hemmed	382	509	605	733	860	956	1,083	1,210	1,307	1,434
18	Hemmed	400	533	633	767	900	1,000	1,133	1,266	1,367	1,500
19	Hemmed	418	557	661	801	940	1,044	1,183	1,322	1,427	1,566
20	Hemmed	436	581	689	835	980	1,088	1,233	1,378	1,487	1,632
21	Hemmed	454	605	717	869	1,020	1,132	1,283	1,434	1,547	1,698
22	Hemmed	472	629	745	903	1,060	1,176	1,333	1,490	1,607	1,764
23	Hemmed	490	653	773	937	1,100	1,220	1,383	1,546	1,667	1,830
24	Hemmed	508	677	801	971	1,140	1,264	1,433	1,602	1,727	1,896
25	Hemmed	535	713	843	1,022	1,200	1,330	1,508	1,686	1,817	1,995
26	Hemmed	553	737	871	1,056	1,240	1,374	1,558	1,742	1,877	2,061
27	Hemmed	571	761	899	1,090	1,280	1,418	1,608	1,798	1,937	2,127
28	Hemmed	589	785	927	1,124	1,320	1,462	1,658	1,854	1,997	2,193
29	Hemmed	607	809	955	1,158	1,360	1,506	1,708	1,910	2,057	2,259
30	Hemmed	634	845	997	1,209	1,420	1,572	1,783	1,994	2,147	2,358
31	Hemmed	648	863	1,018	1,234	1,450	1,605	1,821	2,036	2,192	2,407
32	Hemmed	666	887	1,046	1,268	1,490	1,649	1,871	2,092	2,252	2,473
33	Hemmed	688	917	1,081	1,311	1,540	1,704	1,933	2,162	2,327	2,556
34	Hemmed	733	977	1,151	1,396	1,640	1,814	2,058	2,302	2,477	2,721
35	Hemmed	778	1,037	1,221	1,481	1,740	1,924	2,183	2,442	2,627	2,886
36	Hemmed	832	1,109	1,305	1,583	1,860	2,056	2,333	2,610	2,807	3,084

PLEATED DRAPERIES: 4 Fullness — Lined (Lining 01000)

Maximum length 109" with Eurohem (exceptions may apply). Sizes and series numbers beyond what is listed in the charts below are available—please submit these quote requests via fax or email.

Series		Finished Pair or Panel Width									
		36"	48"	60"	72"	84"	96"	108"	120"	132"	144"
07	Eurohem	339	451	539	652	764	852	965	1,077	1,165	1,278
08	Eurohem	361	481	574	694	814	907	1,027	1,147	1,240	1,360
09	Eurohem	379	505	602	728	854	951	1,077	1,203	1,300	1,426
10	Eurohem	397	529	630	762	894	995	1,127	1,259	1,360	1,492
11	Eurohem	415	553	658	796	934	1,039	1,177	1,315	1,420	1,558
12	Eurohem	433	577	686	830	974	1,083	1,227	1,371	1,480	1,624
13	Eurohem	451	601	714	864	1,014	1,127	1,277	1,427	1,540	1,690
14	Eurohem	469	625	742	898	1,054	1,171	1,327	1,483	1,600	1,756
15	Eurohem	487	649	770	932	1,094	1,215	1,377	1,539	1,660	1,822
16	Eurohem	505	673	798	966	1,134	1,259	1,427	1,595	1,720	1,888
17	Eurohem	523	697	826	1,000	1,174	1,303	1,477	1,651	1,780	1,954
18	Eurohem	541	721	854	1,034	1,214	1,347	1,527	1,707	1,840	2,020
19	Eurohem	559	745	882	1,068	1,254	1,391	1,577	1,763	1,900	2,086
20	Eurohem	577	769	910	1,102	1,294	1,435	1,627	1,819	1,960	2,152
21	Eurohem	595	793	938	1,136	1,334	1,479	1,677	1,875	2,020	2,218
22	Eurohem	613	817	966	1,170	1,374	1,523	1,727	1,931	2,080	2,284
23	Eurohem	631	841	994	1,204	1,414	1,567	1,777	1,987	2,140	2,350
24	Eurohem	649	865	1,022	1,238	1,454	1,611	1,827	2,043	2,200	2,416
25	Eurohem	676	901	1,064	1,289	1,514	1,677	1,902	2,127	2,290	2,515
26	Eurohem	694	925	1,092	1,323	1,554	1,721	1,952	2,183	2,350	2,581
27	Eurohem	712	949	1,120	1,357	1,594	1,765	2,002	2,239	2,410	2,647
28	Eurohem	730	973	1,148	1,391	1,634	1,809	2,052	2,295	2,470	2,713
29	Eurohem	748	997	1,176	1,425	1,674	1,853	2,102	2,351	2,530	2,779
30	Eurohem	775	1,033	1,218	1,476	1,734	1,919	2,177	2,435	2,620	2,878
31	Eurohem	789	1,051	1,239	1,502	1,764	1,952	2,215	2,477	2,665	2,928
32	Eurohem	807	1,075	1,267	1,536	1,804	1,996	2,265	2,533	2,725	2,994
33	Eurohem	829	1,105	1,302	1,578	1,854	2,051	2,327	2,603	2,800	3,076
34	Eurohem	874	1,165	1,372	1,663	1,954	2,161	2,452	2,743	2,950	3,241
35	Eurohem	919	1,225	1,442	1,748	2,054	2,271	2,577	2,883	3,100	3,406
36	Eurohem	973	1,297	1,526	1,850	2,174	2,403	2,727	3,051	3,280	3,604

Maximum length 101" with 4" hem (exceptions may apply).

Series		Finished Pair or Panel Width									
		36"	48"	60"	72"	84"	96"	108"	120"	132"	144"
07	Hemmed	359	479	573	693	812	907	1,026	1,146	1,240	1,360
08	Hemmed	382	509	608	735	862	962	1,089	1,216	1,315	1,442
09	Hemmed	400	533	636	769	902	1,006	1,139	1,272	1,375	1,508
10	Hemmed	418	557	664	803	942	1,050	1,189	1,328	1,435	1,574
11	Hemmed	436	581	692	837	982	1,094	1,239	1,384	1,495	1,640
12	Hemmed	454	605	720	871	1,022	1,138	1,289	1,440	1,555	1,706
13	Hemmed	472	629	748	905	1,062	1,182	1,339	1,496	1,615	1,772
14	Hemmed	490	653	776	939	1,102	1,226	1,389	1,552	1,675	1,838
15	Hemmed	508	677	804	973	1,142	1,270	1,439	1,608	1,735	1,904
16	Hemmed	526	701	832	1,007	1,182	1,314	1,489	1,664	1,795	1,970
17	Hemmed	544	725	860	1,041	1,222	1,358	1,539	1,720	1,855	2,036
18	Hemmed	562	749	888	1,075	1,262	1,402	1,589	1,776	1,915	2,102
19	Hemmed	580	773	916	1,109	1,302	1,446	1,639	1,832	1,975	2,168
20	Hemmed	598	797	944	1,143	1,342	1,490	1,689	1,888	2,035	2,234
21	Hemmed	616	821	972	1,177	1,382	1,534	1,739	1,944	2,095	2,300
22	Hemmed	634	845	1,000	1,211	1,422	1,578	1,789	2,000	2,155	2,366
23	Hemmed	652	869	1,028	1,245	1,462	1,622	1,839	2,056	2,215	2,432
24	Hemmed	670	893	1,056	1,279	1,502	1,666	1,889	2,112	2,275	2,498
25	Hemmed	697	929	1,098	1,330	1,562	1,732	1,964	2,196	2,365	2,597
26	Hemmed	715	953	1,126	1,364	1,602	1,776	2,014	2,252	2,425	2,663
27	Hemmed	733	977	1,154	1,398	1,642	1,820	2,064	2,308	2,485	2,729
28	Hemmed	751	1,001	1,182	1,432	1,682	1,864	2,114	2,364	2,545	2,795
29	Hemmed	769	1,025	1,210	1,466	1,722	1,908	2,164	2,420	2,605	2,861
30	Hemmed	796	1,061	1,252	1,517	1,782	1,974	2,239	2,504	2,695	2,960
31	Hemmed	809	1,079	1,273	1,543	1,812	2,007	2,276	2,546	2,740	3,010
32	Hemmed	827	1,103	1,301	1,577	1,852	2,051	2,326	2,602	2,800	3,076
33	Hemmed	850	1,133	1,336	1,619	1,902	2,106	2,389	2,672	2,875	3,158
34	Hemmed	895	1,193	1,406	1,704	2,002	2,216	2,514	2,812	3,025	3,323
35	Hemmed	940	1,253	1,476	1,789	2,102	2,326	2,639	2,952	3,175	3,488
36	Hemmed	994	1,325	1,560	1,891	2,222	2,458	2,789	3,120	3,355	3,686

GROMMET: 2 Fullness — Unlined

Maximum length 109" with Eurohem (exceptions may apply). Sizes and series numbers beyond what is listed in the charts below are available—please submit these quote requests via fax or email.

Series		Finished Pair or Panel Width									
		36"	48"	60"	72"	84"	96"	108"	120"	132"	144"
07	Eurohem	135	172	220	258	296	344	382	419	468	505
08	Eurohem	147	187	240	281	321	374	414	454	508	548
09	Eurohem	157	199	256	299	341	398	440	482	540	582
10	Eurohem	167	211	272	317	361	422	466	510	572	616
11	Eurohem	177	223	288	335	381	446	492	538	604	650
12	Eurohem	187	235	304	353	401	470	518	566	636	684
13	Eurohem	197	247	320	371	421	494	544	594	668	718
14	Eurohem	207	259	336	389	441	518	570	622	700	752
15	Eurohem	217	271	352	407	461	542	596	650	732	786
16	Eurohem	227	283	368	425	481	566	622	678	764	820
17	Eurohem	237	295	384	443	501	590	648	706	796	854
18	Eurohem	247	307	400	461	521	614	674	734	828	888
19	Eurohem	257	319	416	479	541	638	700	762	860	922
20	Eurohem	267	331	432	497	561	662	726	790	892	956
21	Eurohem	277	343	448	515	581	686	752	818	924	990
22	Eurohem	287	355	464	533	601	710	778	846	956	1,024
23	Eurohem	297	367	480	551	621	734	804	874	988	1,058
24	Eurohem	307	379	496	569	641	758	830	902	1,020	1,092
25	Eurohem	322	397	520	596	671	794	869	944	1,068	1,143
26	Eurohem	332	409	536	614	691	818	895	972	1,100	1,177
27	Eurohem	342	421	552	632	711	842	921	1,000	1,132	1,211
28	Eurohem	352	433	568	650	731	866	947	1,028	1,164	1,245
29	Eurohem	362	445	584	668	751	890	973	1,056	1,196	1,279
30	Eurohem	377	463	608	695	781	926	1,012	1,098	1,244	1,330
31	Eurohem	385	472	620	708	796	944	1,032	1,119	1,268	1,355
32	Eurohem	395	484	636	726	816	968	1,058	1,147	1,300	1,389
33	Eurohem	407	499	656	749	841	998	1,090	1,182	1,340	1,432
34	Eurohem	432	529	696	794	891	1,058	1,155	1,252	1,420	1,517
35	Eurohem	457	559	736	839	941	1,118	1,220	1,322	1,500	1,602
36	Eurohem	487	595	784	893	1,001	1,190	1,298	1,406	1,596	1,704

Maximum length 101" with 4" hem (exceptions may apply).

Series		Finished Pair or Panel Width									
		36"	48"	60"	72"	84"	96"	108"	120"	132"	144"
07	Hemmed	149	191	244	287	329	382	425	467	520	563
08	Hemmed	161	206	264	309	354	412	457	502	560	605
09	Hemmed	171	218	280	327	374	436	483	530	592	639
10	Hemmed	181	230	296	345	394	460	509	558	624	673
11	Hemmed	191	242	312	363	414	484	535	586	656	707
12	Hemmed	201	254	328	381	434	508	561	614	688	741
13	Hemmed	211	266	344	399	454	532	587	642	720	775
14	Hemmed	221	278	360	417	474	556	613	670	752	809
15	Hemmed	231	290	376	435	494	580	639	698	784	843
16	Hemmed	241	302	392	453	514	604	665	726	816	877
17	Hemmed	251	314	408	471	534	628	691	754	848	911
18	Hemmed	261	326	424	489	554	652	717	782	880	945
19	Hemmed	271	338	440	507	574	676	743	810	912	979
20	Hemmed	281	350	456	525	594	700	769	838	944	1,013
21	Hemmed	291	362	472	543	614	724	795	866	976	1,047
22	Hemmed	301	374	488	561	634	748	821	894	1,008	1,081
23	Hemmed	311	386	504	579	654	772	847	922	1,040	1,115
24	Hemmed	321	398	520	597	674	796	873	950	1,072	1,149
25	Hemmed	336	416	544	624	704	832	912	992	1,120	1,200
26	Hemmed	346	428	560	642	724	856	938	1,020	1,152	1,234
27	Hemmed	356	440	576	660	744	880	964	1,048	1,184	1,268
28	Hemmed	366	452	592	678	764	904	990	1,076	1,216	1,302
29	Hemmed	376	464	608	696	784	928	1,016	1,104	1,248	1,336
30	Hemmed	391	482	632	723	814	964	1,055	1,146	1,296	1,387
31	Hemmed	399	491	644	737	829	982	1,075	1,167	1,320	1,413
32	Hemmed	409	503	660	755	849	1,006	1,101	1,195	1,352	1,447
33	Hemmed	421	518	680	777	874	1,036	1,133	1,230	1,392	1,489
34	Hemmed	446	548	720	822	924	1,096	1,198	1,300	1,472	1,574
35	Hemmed	471	578	760	867	974	1,156	1,263	1,370	1,552	1,659
36	Hemmed	501	614	808	921	1,034	1,228	1,341	1,454	1,648	1,761

GROMMET: 2 Fullness — Lined (Lining 01000)

Maximum length 109" with Eurohem (exceptions may apply). Sizes and series numbers beyond what is listed in the charts below are available—please submit these quote requests via fax or email.

Series		Finished Pair or Panel Width									
		36"	48"	60"	72"	84"	96"	108"	120"	132"	144"
07	Eurohem	226	285	368	427	485	569	628	686	770	828
08	Eurohem	239	300	388	449	510	599	660	721	810	871
09	Eurohem	249	312	404	467	530	623	686	749	842	905
10	Eurohem	259	324	420	485	550	647	712	777	874	939
11	Eurohem	269	336	436	503	570	671	738	805	906	973
12	Eurohem	279	348	452	521	590	695	764	833	938	1,007
13	Eurohem	289	360	468	539	610	719	790	861	970	1,041
14	Eurohem	299	372	484	557	630	743	816	889	1,002	1,075
15	Eurohem	309	384	500	575	650	767	842	917	1,034	1,109
16	Eurohem	319	396	516	593	670	791	868	945	1,066	1,143
17	Eurohem	329	408	532	611	690	815	894	973	1,098	1,177
18	Eurohem	339	420	548	629	710	839	920	1,001	1,130	1,211
19	Eurohem	349	432	564	647	730	863	946	1,029	1,162	1,245
20	Eurohem	359	444	580	665	750	887	972	1,057	1,194	1,279
21	Eurohem	369	456	596	683	770	911	998	1,085	1,226	1,313
22	Eurohem	379	468	612	701	790	935	1,024	1,113	1,258	1,347
23	Eurohem	389	480	628	719	810	959	1,050	1,141	1,290	1,381
24	Eurohem	399	492	644	737	830	983	1,076	1,169	1,322	1,415
25	Eurohem	414	510	668	764	860	1,019	1,115	1,211	1,370	1,466
26	Eurohem	424	522	684	782	880	1,043	1,141	1,239	1,402	1,500
27	Eurohem	434	534	700	800	900	1,067	1,167	1,267	1,434	1,534
28	Eurohem	444	546	716	818	920	1,091	1,193	1,295	1,466	1,568
29	Eurohem	454	558	732	836	940	1,115	1,219	1,323	1,498	1,602
30	Eurohem	469	576	756	863	970	1,151	1,258	1,365	1,546	1,653
31	Eurohem	476	585	768	877	985	1,169	1,278	1,386	1,570	1,678
32	Eurohem	486	597	784	895	1,005	1,193	1,304	1,414	1,602	1,712
33	Eurohem	499	612	804	917	1,030	1,223	1,336	1,449	1,642	1,755
34	Eurohem	524	642	844	962	1,080	1,283	1,401	1,519	1,722	1,840
35	Eurohem	549	672	884	1,007	1,130	1,343	1,466	1,589	1,802	1,925
36	Eurohem	579	708	932	1,061	1,190	1,415	1,544	1,673	1,898	2,027

Maximum length 101" with 4" hem (exceptions may apply).

Series		Finished Pair or Panel Width									
		36"	48"	60"	72"	84"	96"	108"	120"	132"	144"
07	Hemmed	241	304	392	456	519	607	671	734	822	886
08	Hemmed	253	319	412	478	544	637	703	769	862	928
09	Hemmed	263	331	428	496	564	661	729	797	894	962
10	Hemmed	273	343	444	514	584	685	755	825	926	996
11	Hemmed	283	355	460	532	604	709	781	853	958	1,030
12	Hemmed	293	367	476	550	624	733	807	881	990	1,064
13	Hemmed	303	379	492	568	644	757	833	909	1,022	1,098
14	Hemmed	313	391	508	586	664	781	859	937	1,054	1,132
15	Hemmed	323	403	524	604	684	805	885	965	1,086	1,166
16	Hemmed	333	415	540	622	704	829	911	993	1,118	1,200
17	Hemmed	343	427	556	640	724	853	937	1,021	1,150	1,234
18	Hemmed	353	439	572	658	744	877	963	1,049	1,182	1,268
19	Hemmed	363	451	588	676	764	901	989	1,077	1,214	1,302
20	Hemmed	373	463	604	694	784	925	1,015	1,105	1,246	1,336
21	Hemmed	383	475	620	712	804	949	1,041	1,133	1,278	1,370
22	Hemmed	393	487	636	730	824	973	1,067	1,161	1,310	1,404
23	Hemmed	403	499	652	748	844	997	1,093	1,189	1,342	1,438
24	Hemmed	413	511	668	766	864	1,021	1,119	1,217	1,374	1,472
25	Hemmed	428	529	692	793	894	1,057	1,158	1,259	1,422	1,523
26	Hemmed	438	541	708	811	914	1,081	1,184	1,287	1,454	1,557
27	Hemmed	448	553	724	829	934	1,105	1,210	1,315	1,486	1,591
28	Hemmed	458	565	740	847	954	1,129	1,236	1,343	1,518	1,625
29	Hemmed	468	577	756	865	974	1,153	1,262	1,371	1,550	1,659
30	Hemmed	483	595	780	892	1,004	1,189	1,301	1,413	1,598	1,710
31	Hemmed	491	604	792	906	1,019	1,207	1,321	1,434	1,622	1,736
32	Hemmed	501	616	808	924	1,039	1,231	1,347	1,462	1,654	1,770
33	Hemmed	513	631	828	946	1,064	1,261	1,379	1,497	1,694	1,812
34	Hemmed	538	661	868	991	1,114	1,321	1,444	1,567	1,774	1,897
35	Hemmed	563	691	908	1,036	1,164	1,381	1,509	1,637	1,854	1,982
36	Hemmed	593	727	956	1,090	1,224	1,453	1,587	1,721	1,950	2,084

GROMMET: 2.5 Fullness — Unlined

Maximum length 109" with Eurohem (exceptions may apply). Sizes and series numbers beyond what is listed in the charts below are available—please submit these quote requests via fax or email.

Series		Finished Pair or Panel Width									
		36"	48"	60"	72"	84"	96"	108"	120"	132"	144"
07	Eurohem	145	193	231	279	327	365	413	461	499	547
08	Eurohem	160	213	253	307	360	400	453	506	547	600
09	Eurohem	172	229	271	329	386	428	485	542	585	642
10	Eurohem	184	245	289	351	412	456	517	578	623	684
11	Eurohem	196	261	307	373	438	484	549	614	661	726
12	Eurohem	208	277	325	395	464	512	581	650	699	768
13	Eurohem	220	293	343	417	490	540	613	686	737	810
14	Eurohem	232	309	361	439	516	568	645	722	775	852
15	Eurohem	244	325	379	461	542	596	677	758	813	894
16	Eurohem	256	341	397	483	568	624	709	794	851	936
17	Eurohem	268	357	415	505	594	652	741	830	889	978
18	Eurohem	280	373	433	527	620	680	773	866	927	1,020
19	Eurohem	292	389	451	549	646	708	805	902	965	1,062
20	Eurohem	304	405	469	571	672	736	837	938	1,003	1,104
21	Eurohem	316	421	487	593	698	764	869	974	1,041	1,146
22	Eurohem	328	437	505	615	724	792	901	1,010	1,079	1,188
23	Eurohem	340	453	523	637	750	820	933	1,046	1,117	1,230
24	Eurohem	352	469	541	659	776	848	965	1,082	1,155	1,272
25	Eurohem	370	493	568	692	815	890	1,013	1,136	1,212	1,335
26	Eurohem	382	509	586	714	841	918	1,045	1,172	1,250	1,377
27	Eurohem	394	525	604	736	867	946	1,077	1,208	1,288	1,419
28	Eurohem	406	541	622	758	893	974	1,109	1,244	1,326	1,461
29	Eurohem	418	557	640	780	919	1,002	1,141	1,280	1,364	1,503
30	Eurohem	436	581	667	813	958	1,044	1,189	1,334	1,421	1,566
31	Eurohem	445	593	681	829	977	1,065	1,213	1,361	1,449	1,597
32	Eurohem	457	609	699	851	1,003	1,093	1,245	1,397	1,487	1,639
33	Eurohem	472	629	721	879	1,036	1,128	1,285	1,442	1,535	1,692
34	Eurohem	502	669	766	934	1,101	1,198	1,365	1,532	1,630	1,797
35	Eurohem	532	709	811	989	1,166	1,268	1,445	1,622	1,725	1,902
36	Eurohem	568	757	865	1,055	1,244	1,352	1,541	1,730	1,839	2,028

Maximum length 101" with 4" hem (exceptions may apply).

Series		Finished Pair or Panel Width									
		36"	48"	60"	72"	84"	96"	108"	120"	132"	144"
07	Hemmed	159	212	255	308	361	403	456	509	552	605
08	Hemmed	174	232	277	335	393	438	496	554	599	657
09	Hemmed	186	248	295	357	419	466	528	590	637	699
10	Hemmed	198	264	313	379	445	494	560	626	675	741
11	Hemmed	210	280	331	401	471	522	592	662	713	783
12	Hemmed	222	296	349	423	497	550	624	698	751	825
13	Hemmed	234	312	367	445	523	578	656	734	789	867
14	Hemmed	246	328	385	467	549	606	688	770	827	909
15	Hemmed	258	344	403	489	575	634	720	806	865	951
16	Hemmed	270	360	421	511	601	662	752	842	903	993
17	Hemmed	282	376	439	533	627	690	784	878	941	1,035
18	Hemmed	294	392	457	555	653	718	816	914	979	1,077
19	Hemmed	306	408	475	577	679	746	848	950	1,017	1,119
20	Hemmed	318	424	493	599	705	774	880	986	1,055	1,161
21	Hemmed	330	440	511	621	731	802	912	1,022	1,093	1,203
22	Hemmed	342	456	529	643	757	830	944	1,058	1,131	1,245
23	Hemmed	354	472	547	665	783	858	976	1,094	1,169	1,287
24	Hemmed	366	488	565	687	809	886	1,008	1,130	1,207	1,329
25	Hemmed	384	512	592	720	848	928	1,056	1,184	1,264	1,392
26	Hemmed	396	528	610	742	874	956	1,088	1,220	1,302	1,434
27	Hemmed	408	544	628	764	900	984	1,120	1,256	1,340	1,476
28	Hemmed	420	560	646	786	926	1,012	1,152	1,292	1,378	1,518
29	Hemmed	432	576	664	808	952	1,040	1,184	1,328	1,416	1,560
30	Hemmed	450	600	691	841	991	1,082	1,232	1,382	1,473	1,623
31	Hemmed	459	612	705	858	1,011	1,103	1,256	1,409	1,502	1,655
32	Hemmed	471	628	723	880	1,037	1,131	1,288	1,445	1,540	1,697
33	Hemmed	486	648	745	907	1,069	1,166	1,328	1,490	1,587	1,749
34	Hemmed	516	688	790	962	1,134	1,236	1,408	1,580	1,682	1,854
35	Hemmed	546	728	835	1,017	1,199	1,306	1,488	1,670	1,777	1,959
36	Hemmed	582	776	889	1,083	1,277	1,390	1,584	1,778	1,891	2,085

GROMMET: 2.5 Fullness — Lined (Lining 01000)

Maximum length 109" with Eurohem (exceptions may apply). Sizes and series numbers beyond what is listed in the charts below are available—please submit these quote requests via fax or email.

Series		Finished Pair or Panel Width									
		36"	48"	60"	72"	84"	96"	108"	120"	132"	144"
07	Eurohem	251	335	393	477	560	619	703	786	845	928
08	Eurohem	266	355	416	504	593	654	743	831	892	981
09	Eurohem	278	371	434	526	619	682	775	867	930	1,023
10	Eurohem	290	387	452	548	645	710	807	903	968	1,065
11	Eurohem	302	403	470	570	671	738	839	939	1,006	1,107
12	Eurohem	314	419	488	592	697	766	871	975	1,044	1,149
13	Eurohem	326	435	506	614	723	794	903	1,011	1,082	1,191
14	Eurohem	338	451	524	636	749	822	935	1,047	1,120	1,233
15	Eurohem	350	467	542	658	775	850	967	1,083	1,158	1,275
16	Eurohem	362	483	560	680	801	878	999	1,119	1,196	1,317
17	Eurohem	374	499	578	702	827	906	1,031	1,155	1,234	1,359
18	Eurohem	386	515	596	724	853	934	1,063	1,191	1,272	1,401
19	Eurohem	398	531	614	746	879	962	1,095	1,227	1,310	1,443
20	Eurohem	410	547	632	768	905	990	1,127	1,263	1,348	1,485
21	Eurohem	422	563	650	790	931	1,018	1,159	1,299	1,386	1,527
22	Eurohem	434	579	668	812	957	1,046	1,191	1,335	1,424	1,569
23	Eurohem	446	595	686	834	983	1,074	1,223	1,371	1,462	1,611
24	Eurohem	458	611	704	856	1,009	1,102	1,255	1,407	1,500	1,653
25	Eurohem	476	635	731	889	1,048	1,144	1,303	1,461	1,557	1,716
26	Eurohem	488	651	749	911	1,074	1,172	1,335	1,497	1,595	1,758
27	Eurohem	500	667	767	933	1,100	1,200	1,367	1,533	1,633	1,800
28	Eurohem	512	683	785	955	1,126	1,228	1,399	1,569	1,671	1,842
29	Eurohem	524	699	803	977	1,152	1,256	1,431	1,605	1,709	1,884
30	Eurohem	542	723	830	1,010	1,191	1,298	1,479	1,659	1,766	1,947
31	Eurohem	551	735	843	1,027	1,210	1,319	1,503	1,686	1,795	1,978
32	Eurohem	563	751	861	1,049	1,236	1,347	1,535	1,722	1,833	2,020
33	Eurohem	578	771	884	1,076	1,269	1,382	1,575	1,767	1,880	2,073
34	Eurohem	608	811	929	1,131	1,334	1,452	1,655	1,857	1,975	2,178
35	Eurohem	638	851	974	1,186	1,399	1,522	1,735	1,947	2,070	2,283
36	Eurohem	674	899	1,028	1,252	1,477	1,606	1,831	2,055	2,184	2,409

Maximum length 101" with 4" hem (exceptions may apply).

Series		Finished Pair or Panel Width									
		36"	48"	60"	72"	84"	96"	108"	120"	132"	144"
07	Hemmed	266	354	417	506	594	657	746	834	897	986
08	Hemmed	281	374	440	533	627	692	786	879	945	1,038
09	Hemmed	293	390	458	555	653	720	818	915	983	1,080
10	Hemmed	305	406	476	577	679	748	850	951	1,021	1,122
11	Hemmed	317	422	494	599	705	776	882	987	1,059	1,164
12	Hemmed	329	438	512	621	731	804	914	1,023	1,097	1,206
13	Hemmed	341	454	530	643	757	832	946	1,059	1,135	1,248
14	Hemmed	353	470	548	665	783	860	978	1,095	1,173	1,290
15	Hemmed	365	486	566	687	809	888	1,010	1,131	1,211	1,332
16	Hemmed	377	502	584	709	835	916	1,042	1,167	1,249	1,374
17	Hemmed	389	518	602	731	861	944	1,074	1,203	1,287	1,416
18	Hemmed	401	534	620	753	887	972	1,106	1,239	1,325	1,458
19	Hemmed	413	550	638	775	913	1,000	1,138	1,275	1,363	1,500
20	Hemmed	425	566	656	797	939	1,028	1,170	1,311	1,401	1,542
21	Hemmed	437	582	674	819	965	1,056	1,202	1,347	1,439	1,584
22	Hemmed	449	598	692	841	991	1,084	1,234	1,383	1,477	1,626
23	Hemmed	461	614	710	863	1,017	1,112	1,266	1,419	1,515	1,668
24	Hemmed	473	630	728	885	1,043	1,140	1,298	1,455	1,553	1,710
25	Hemmed	491	654	755	918	1,082	1,182	1,346	1,509	1,610	1,773
26	Hemmed	503	670	773	940	1,108	1,210	1,378	1,545	1,648	1,815
27	Hemmed	515	686	791	962	1,134	1,238	1,410	1,581	1,686	1,857
28	Hemmed	527	702	809	984	1,160	1,266	1,442	1,617	1,724	1,899
29	Hemmed	539	718	827	1,006	1,186	1,294	1,474	1,653	1,762	1,941
30	Hemmed	557	742	854	1,039	1,225	1,336	1,522	1,707	1,819	2,004
31	Hemmed	566	754	867	1,056	1,244	1,357	1,546	1,734	1,847	2,036
32	Hemmed	578	770	885	1,078	1,270	1,385	1,578	1,770	1,885	2,078
33	Hemmed	593	790	908	1,105	1,303	1,420	1,618	1,815	1,933	2,130
34	Hemmed	623	830	953	1,160	1,368	1,490	1,698	1,905	2,028	2,235
35	Hemmed	653	870	998	1,215	1,433	1,560	1,778	1,995	2,123	2,340
36	Hemmed	689	918	1,052	1,281	1,511	1,644	1,874	2,103	2,237	2,466

GROMMET: 3 Fullness — Unlined

Maximum length 109" with Eurohem (exceptions may apply). Sizes and series numbers beyond what is listed in the charts below are available—please submit these quote requests via fax or email.

Series		Finished Pair or Panel Width									
		36"	48"	60"	72"	84"	96"	108"	120"	132"	144"
07	Eurohem	156	204	252	300	348	397	445	493	541	589
08	Eurohem	173	226	279	333	386	439	492	545	599	652
09	Eurohem	187	244	301	359	416	473	530	587	645	702
10	Eurohem	201	262	323	385	446	507	568	629	691	752
11	Eurohem	215	280	345	411	476	541	606	671	737	802
12	Eurohem	229	298	367	437	506	575	644	713	783	852
13	Eurohem	243	316	389	463	536	609	682	755	829	902
14	Eurohem	257	334	411	489	566	643	720	797	875	952
15	Eurohem	271	352	433	515	596	677	758	839	921	1,002
16	Eurohem	285	370	455	541	626	711	796	881	967	1,052
17	Eurohem	299	388	477	567	656	745	834	923	1,013	1,102
18	Eurohem	313	406	499	593	686	779	872	965	1,059	1,152
19	Eurohem	327	424	521	619	716	813	910	1,007	1,105	1,202
20	Eurohem	341	442	543	645	746	847	948	1,049	1,151	1,252
21	Eurohem	355	460	565	671	776	881	986	1,091	1,197	1,302
22	Eurohem	369	478	587	697	806	915	1,024	1,133	1,243	1,352
23	Eurohem	383	496	609	723	836	949	1,062	1,175	1,289	1,402
24	Eurohem	397	514	631	749	866	983	1,100	1,217	1,335	1,452
25	Eurohem	418	541	664	788	911	1,034	1,157	1,280	1,404	1,527
26	Eurohem	432	559	686	814	941	1,068	1,195	1,322	1,450	1,577
27	Eurohem	446	577	708	840	971	1,102	1,233	1,364	1,496	1,627
28	Eurohem	460	595	730	866	1,001	1,136	1,271	1,406	1,542	1,677
29	Eurohem	474	613	752	892	1,031	1,170	1,309	1,448	1,588	1,727
30	Eurohem	495	640	785	931	1,076	1,221	1,366	1,511	1,657	1,802
31	Eurohem	506	654	802	950	1,098	1,247	1,395	1,543	1,691	1,839
32	Eurohem	520	672	824	976	1,128	1,281	1,433	1,585	1,737	1,889
33	Eurohem	537	694	851	1,009	1,166	1,323	1,480	1,637	1,795	1,952
34	Eurohem	572	739	906	1,074	1,241	1,408	1,575	1,742	1,910	2,077
35	Eurohem	607	784	961	1,139	1,316	1,493	1,670	1,847	2,025	2,202
36	Eurohem	649	838	1,027	1,217	1,406	1,595	1,784	1,973	2,163	2,352

Maximum length 101" with 4" hem (exceptions may apply).

Series		Finished Pair or Panel Width									
		36"	48"	60"	72"	84"	96"	108"	120"	132"	144"
07	Hemmed	170	223	276	329	382	435	488	541	594	647
08	Hemmed	187	245	303	361	419	477	535	593	651	709
09	Hemmed	201	263	325	387	449	511	573	635	697	759
10	Hemmed	215	281	347	413	479	545	611	677	743	809
11	Hemmed	229	299	369	439	509	579	649	719	789	859
12	Hemmed	243	317	391	465	539	613	687	761	835	909
13	Hemmed	257	335	413	491	569	647	725	803	881	959
14	Hemmed	271	353	435	517	599	681	763	845	927	1,009
15	Hemmed	285	371	457	543	629	715	801	887	973	1,059
16	Hemmed	299	389	479	569	659	749	839	929	1,019	1,109
17	Hemmed	313	407	501	595	689	783	877	971	1,065	1,159
18	Hemmed	327	425	523	621	719	817	915	1,013	1,111	1,209
19	Hemmed	341	443	545	647	749	851	953	1,055	1,157	1,259
20	Hemmed	355	461	567	673	779	885	991	1,097	1,203	1,309
21	Hemmed	369	479	589	699	809	919	1,029	1,139	1,249	1,359
22	Hemmed	383	497	611	725	839	953	1,067	1,181	1,295	1,409
23	Hemmed	397	515	633	751	869	987	1,105	1,223	1,341	1,459
24	Hemmed	411	533	655	777	899	1,021	1,143	1,265	1,387	1,509
25	Hemmed	432	560	688	816	944	1,072	1,200	1,328	1,456	1,584
26	Hemmed	446	578	710	842	974	1,106	1,238	1,370	1,502	1,634
27	Hemmed	460	596	732	868	1,004	1,140	1,276	1,412	1,548	1,684
28	Hemmed	474	614	754	894	1,034	1,174	1,314	1,454	1,594	1,734
29	Hemmed	488	632	776	920	1,064	1,208	1,352	1,496	1,640	1,784
30	Hemmed	509	659	809	959	1,109	1,259	1,409	1,559	1,709	1,859
31	Hemmed	520	673	826	979	1,132	1,285	1,438	1,591	1,744	1,897
32	Hemmed	534	691	848	1,005	1,162	1,319	1,476	1,633	1,790	1,947
33	Hemmed	551	713	875	1,037	1,199	1,361	1,523	1,685	1,847	2,009
34	Hemmed	586	758	930	1,102	1,274	1,446	1,618	1,790	1,962	2,134
35	Hemmed	621	803	985	1,167	1,349	1,531	1,713	1,895	2,077	2,259
36	Hemmed	663	857	1,051	1,245	1,439	1,633	1,827	2,021	2,215	2,409

GROMMET: 3 Fullness — Lined (Lining 01000)

Maximum length 109" with Eurohem (exceptions may apply). Sizes and series numbers beyond what is listed in the charts below are available—please submit these quote requests via fax or email.

Series		Finished Pair or Panel Width									
		36"	48"	60"	72"	84"	96"	108"	120"	132"	144"
07	Eurohem	276	360	443	527	610	694	778	861	945	1,028
08	Eurohem	294	382	471	559	648	736	825	914	1,002	1,091
09	Eurohem	308	400	493	585	678	770	863	956	1,048	1,141
10	Eurohem	322	418	515	611	708	804	901	998	1,094	1,191
11	Eurohem	336	436	537	637	738	838	939	1,040	1,140	1,241
12	Eurohem	350	454	559	663	768	872	977	1,082	1,186	1,291
13	Eurohem	364	472	581	689	798	906	1,015	1,124	1,232	1,341
14	Eurohem	378	490	603	715	828	940	1,053	1,166	1,278	1,391
15	Eurohem	392	508	625	741	858	974	1,091	1,208	1,324	1,441
16	Eurohem	406	526	647	767	888	1,008	1,129	1,250	1,370	1,491
17	Eurohem	420	544	669	793	918	1,042	1,167	1,292	1,416	1,541
18	Eurohem	434	562	691	819	948	1,076	1,205	1,334	1,462	1,591
19	Eurohem	448	580	713	845	978	1,110	1,243	1,376	1,508	1,641
20	Eurohem	462	598	735	871	1,008	1,144	1,281	1,418	1,554	1,691
21	Eurohem	476	616	757	897	1,038	1,178	1,319	1,460	1,600	1,741
22	Eurohem	490	634	779	923	1,068	1,212	1,357	1,502	1,646	1,791
23	Eurohem	504	652	801	949	1,098	1,246	1,395	1,544	1,692	1,841
24	Eurohem	518	670	823	975	1,128	1,280	1,433	1,586	1,738	1,891
25	Eurohem	539	697	856	1,014	1,173	1,331	1,490	1,649	1,807	1,966
26	Eurohem	553	715	878	1,040	1,203	1,365	1,528	1,691	1,853	2,016
27	Eurohem	567	733	900	1,066	1,233	1,399	1,566	1,733	1,899	2,066
28	Eurohem	581	751	922	1,092	1,263	1,433	1,604	1,775	1,945	2,116
29	Eurohem	595	769	944	1,118	1,293	1,467	1,642	1,817	1,991	2,166
30	Eurohem	616	796	977	1,157	1,338	1,518	1,699	1,880	2,060	2,241
31	Eurohem	626	810	993	1,177	1,360	1,544	1,728	1,911	2,095	2,278
32	Eurohem	640	828	1,015	1,203	1,390	1,578	1,766	1,953	2,141	2,328
33	Eurohem	658	850	1,043	1,235	1,428	1,620	1,813	2,006	2,198	2,391
34	Eurohem	693	895	1,098	1,300	1,503	1,705	1,908	2,111	2,313	2,516
35	Eurohem	728	940	1,153	1,365	1,578	1,790	2,003	2,216	2,428	2,641
36	Eurohem	770	994	1,219	1,443	1,668	1,892	2,117	2,342	2,566	2,791

Maximum length 101" with 4" hem (exceptions may apply).

Series		Finished Pair or Panel Width									
		36"	48"	60"	72"	84"	96"	108"	120"	132"	144"
07	Hemmed	291	379	467	556	644	732	821	909	997	1,086
08	Hemmed	308	401	495	588	682	775	868	962	1,055	1,148
09	Hemmed	322	419	517	614	712	809	906	1,004	1,101	1,198
10	Hemmed	336	437	539	640	742	843	944	1,046	1,147	1,248
11	Hemmed	350	455	561	666	772	877	982	1,088	1,193	1,298
12	Hemmed	364	473	583	692	802	911	1,020	1,130	1,239	1,348
13	Hemmed	378	491	605	718	832	945	1,058	1,172	1,285	1,398
14	Hemmed	392	509	627	744	862	979	1,096	1,214	1,331	1,448
15	Hemmed	406	527	649	770	892	1,013	1,134	1,256	1,377	1,498
16	Hemmed	420	545	671	796	922	1,047	1,172	1,298	1,423	1,548
17	Hemmed	434	563	693	822	952	1,081	1,210	1,340	1,469	1,598
18	Hemmed	448	581	715	848	982	1,115	1,248	1,382	1,515	1,648
19	Hemmed	462	599	737	874	1,012	1,149	1,286	1,424	1,561	1,698
20	Hemmed	476	617	759	900	1,042	1,183	1,324	1,466	1,607	1,748
21	Hemmed	490	635	781	926	1,072	1,217	1,362	1,508	1,653	1,798
22	Hemmed	504	653	803	952	1,102	1,251	1,400	1,550	1,699	1,848
23	Hemmed	518	671	825	978	1,132	1,285	1,438	1,592	1,745	1,898
24	Hemmed	532	689	847	1,004	1,162	1,319	1,476	1,634	1,791	1,948
25	Hemmed	553	716	880	1,043	1,207	1,370	1,533	1,697	1,860	2,023
26	Hemmed	567	734	902	1,069	1,237	1,404	1,571	1,739	1,906	2,073
27	Hemmed	581	752	924	1,095	1,267	1,438	1,609	1,781	1,952	2,123
28	Hemmed	595	770	946	1,121	1,297	1,472	1,647	1,823	1,998	2,173
29	Hemmed	609	788	968	1,147	1,327	1,506	1,685	1,865	2,044	2,223
30	Hemmed	630	815	1,001	1,186	1,372	1,557	1,742	1,928	2,113	2,298
31	Hemmed	641	829	1,017	1,206	1,394	1,582	1,771	1,959	2,147	2,336
32	Hemmed	655	847	1,039	1,232	1,424	1,616	1,809	2,001	2,193	2,386
33	Hemmed	672	869	1,067	1,264	1,462	1,659	1,856	2,054	2,251	2,448
34	Hemmed	707	914	1,122	1,329	1,537	1,744	1,951	2,159	2,366	2,573
35	Hemmed	742	959	1,177	1,394	1,612	1,829	2,046	2,264	2,481	2,698
36	Hemmed	784	1,013	1,243	1,472	1,702	1,931	2,160	2,390	2,619	2,848

GROMMET: 4 Fullness — Unlined

Maximum length 109" with Eurohem (exceptions may apply). Sizes and series numbers beyond what is listed in the charts below are available—please submit these quote requests via fax or email.

Series		Finished Pair or Panel Width									
		36"	48"	60"	72"	84"	96"	108"	120"	132"	144"
07	Eurohem	177	235	283	342	401	449	508	566	615	673
08	Eurohem	199	265	318	385	451	504	570	636	690	756
09	Eurohem	217	289	346	419	491	548	620	692	750	822
10	Eurohem	235	313	374	453	531	592	670	748	810	888
11	Eurohem	253	337	402	487	571	636	720	804	870	954
12	Eurohem	271	361	430	521	611	680	770	860	930	1,020
13	Eurohem	289	385	458	555	651	724	820	916	990	1,086
14	Eurohem	307	409	486	589	691	768	870	972	1,050	1,152
15	Eurohem	325	433	514	623	731	812	920	1,028	1,110	1,218
16	Eurohem	343	457	542	657	771	856	970	1,084	1,170	1,284
17	Eurohem	361	481	570	691	811	900	1,020	1,140	1,230	1,350
18	Eurohem	379	505	598	725	851	944	1,070	1,196	1,290	1,416
19	Eurohem	397	529	626	759	891	988	1,120	1,252	1,350	1,482
20	Eurohem	415	553	654	793	931	1,032	1,170	1,308	1,410	1,548
21	Eurohem	433	577	682	827	971	1,076	1,220	1,364	1,470	1,614
22	Eurohem	451	601	710	861	1,011	1,120	1,270	1,420	1,530	1,680
23	Eurohem	469	625	738	895	1,051	1,164	1,320	1,476	1,590	1,746
24	Eurohem	487	649	766	929	1,091	1,208	1,370	1,532	1,650	1,812
25	Eurohem	514	685	808	980	1,151	1,274	1,445	1,616	1,740	1,911
26	Eurohem	532	709	836	1,014	1,191	1,318	1,495	1,672	1,800	1,977
27	Eurohem	550	733	864	1,048	1,231	1,362	1,545	1,728	1,860	2,043
28	Eurohem	568	757	892	1,082	1,271	1,406	1,595	1,784	1,920	2,109
29	Eurohem	586	781	920	1,116	1,311	1,450	1,645	1,840	1,980	2,175
30	Eurohem	613	817	962	1,167	1,371	1,516	1,720	1,924	2,070	2,274
31	Eurohem	627	835	983	1,192	1,401	1,549	1,758	1,966	2,115	2,323
32	Eurohem	645	859	1,011	1,226	1,441	1,593	1,808	2,022	2,175	2,389
33	Eurohem	667	889	1,046	1,269	1,491	1,648	1,870	2,092	2,250	2,472
34	Eurohem	712	949	1,116	1,354	1,591	1,758	1,995	2,232	2,400	2,637
35	Eurohem	757	1,009	1,186	1,439	1,691	1,868	2,120	2,372	2,550	2,802
36	Eurohem	811	1,081	1,270	1,541	1,811	2,000	2,270	2,540	2,730	3,000

Maximum length 101" with 4" hem (exceptions may apply).

Series		Finished Pair or Panel Width									
		36"	48"	60"	72"	84"	96"	108"	120"	132"	144"
07	Hemmed	191	254	307	371	434	487	551	614	667	731
08	Hemmed	213	284	342	413	484	542	613	684	742	813
09	Hemmed	231	308	370	447	524	586	663	740	802	879
10	Hemmed	249	332	398	481	564	630	713	796	862	945
11	Hemmed	267	356	426	515	604	674	763	852	922	1,011
12	Hemmed	285	380	454	549	644	718	813	908	982	1,077
13	Hemmed	303	404	482	583	684	762	863	964	1,042	1,143
14	Hemmed	321	428	510	617	724	806	913	1,020	1,102	1,209
15	Hemmed	339	452	538	651	764	850	963	1,076	1,162	1,275
16	Hemmed	357	476	566	685	804	894	1,013	1,132	1,222	1,341
17	Hemmed	375	500	594	719	844	938	1,063	1,188	1,282	1,407
18	Hemmed	393	524	622	753	884	982	1,113	1,244	1,342	1,473
19	Hemmed	411	548	650	787	924	1,026	1,163	1,300	1,402	1,539
20	Hemmed	429	572	678	821	964	1,070	1,213	1,356	1,462	1,605
21	Hemmed	447	596	706	855	1,004	1,114	1,263	1,412	1,522	1,671
22	Hemmed	465	620	734	889	1,044	1,158	1,313	1,468	1,582	1,737
23	Hemmed	483	644	762	923	1,084	1,202	1,363	1,524	1,642	1,803
24	Hemmed	501	668	790	957	1,124	1,246	1,413	1,580	1,702	1,869
25	Hemmed	528	704	832	1,008	1,184	1,312	1,488	1,664	1,792	1,968
26	Hemmed	546	728	860	1,042	1,224	1,356	1,538	1,720	1,852	2,034
27	Hemmed	564	752	888	1,076	1,264	1,400	1,588	1,776	1,912	2,100
28	Hemmed	582	776	916	1,110	1,304	1,444	1,638	1,832	1,972	2,166
29	Hemmed	600	800	944	1,144	1,344	1,488	1,688	1,888	2,032	2,232
30	Hemmed	627	836	986	1,195	1,404	1,554	1,763	1,972	2,122	2,331
31	Hemmed	641	854	1,007	1,221	1,434	1,587	1,801	2,014	2,167	2,381
32	Hemmed	659	878	1,035	1,255	1,474	1,631	1,851	2,070	2,227	2,447
33	Hemmed	681	908	1,070	1,297	1,524	1,686	1,913	2,140	2,302	2,529
34	Hemmed	726	968	1,140	1,382	1,624	1,796	2,038	2,280	2,452	2,694
35	Hemmed	771	1,028	1,210	1,467	1,724	1,906	2,163	2,420	2,602	2,859
36	Hemmed	825	1,100	1,294	1,569	1,844	2,038	2,313	2,588	2,782	3,057

GROMMET: 4 Fullness — Lined (Lining 01000)

Maximum length 109" with Eurohem (exceptions may apply). Sizes and series numbers beyond what is listed in the charts below are available—please submit these quote requests via fax or email.

Series		Finished Pair or Panel Width									
		36"	48"	60"	72"	84"	96"	108"	120"	132"	144"
07	Eurohem	326	435	518	627	735	819	928	1,036	1,120	1,228
08	Eurohem	349	465	553	669	785	874	990	1,106	1,195	1,311
09	Eurohem	367	489	581	703	825	918	1,040	1,162	1,255	1,377
10	Eurohem	385	513	609	737	865	962	1,090	1,218	1,315	1,443
11	Eurohem	403	537	637	771	905	1,006	1,140	1,274	1,375	1,509
12	Eurohem	421	561	665	805	945	1,050	1,190	1,330	1,435	1,575
13	Eurohem	439	585	693	839	985	1,094	1,240	1,386	1,495	1,641
14	Eurohem	457	609	721	873	1,025	1,138	1,290	1,442	1,555	1,707
15	Eurohem	475	633	749	907	1,065	1,182	1,340	1,498	1,615	1,773
16	Eurohem	493	657	777	941	1,105	1,226	1,390	1,554	1,675	1,839
17	Eurohem	511	681	805	975	1,145	1,270	1,440	1,610	1,735	1,905
18	Eurohem	529	705	833	1,009	1,185	1,314	1,490	1,666	1,795	1,971
19	Eurohem	547	729	861	1,043	1,225	1,358	1,540	1,722	1,855	2,037
20	Eurohem	565	753	889	1,077	1,265	1,402	1,590	1,778	1,915	2,103
21	Eurohem	583	777	917	1,111	1,305	1,446	1,640	1,834	1,975	2,169
22	Eurohem	601	801	945	1,145	1,345	1,490	1,690	1,890	2,035	2,235
23	Eurohem	619	825	973	1,179	1,385	1,534	1,740	1,946	2,095	2,301
24	Eurohem	637	849	1,001	1,213	1,425	1,578	1,790	2,002	2,155	2,367
25	Eurohem	664	885	1,043	1,264	1,485	1,644	1,865	2,086	2,245	2,466
26	Eurohem	682	909	1,071	1,298	1,525	1,688	1,915	2,142	2,305	2,532
27	Eurohem	700	933	1,099	1,332	1,565	1,732	1,965	2,198	2,365	2,598
28	Eurohem	718	957	1,127	1,366	1,605	1,776	2,015	2,254	2,425	2,664
29	Eurohem	736	981	1,155	1,400	1,645	1,820	2,065	2,310	2,485	2,730
30	Eurohem	763	1,017	1,197	1,451	1,705	1,886	2,140	2,394	2,575	2,829
31	Eurohem	776	1,035	1,218	1,477	1,735	1,919	2,178	2,436	2,620	2,878
32	Eurohem	794	1,059	1,246	1,511	1,775	1,963	2,228	2,492	2,680	2,944
33	Eurohem	817	1,089	1,281	1,553	1,825	2,018	2,290	2,562	2,755	3,027
34	Eurohem	862	1,149	1,351	1,638	1,925	2,128	2,415	2,702	2,905	3,192
35	Eurohem	907	1,209	1,421	1,723	2,025	2,238	2,540	2,842	3,055	3,357
36	Eurohem	961	1,281	1,505	1,825	2,145	2,370	2,690	3,010	3,235	3,555

Maximum length 101" with 4" hem (exceptions may apply).

Series		Finished Pair or Panel Width									
		36"	48"	60"	72"	84"	96"	108"	120"	132"	144"
07	Hemmed	341	454	542	656	769	857	971	1,084	1,172	1,286
08	Hemmed	363	484	577	698	819	912	1,033	1,154	1,247	1,368
09	Hemmed	381	508	605	732	859	956	1,083	1,210	1,307	1,434
10	Hemmed	399	532	633	766	899	1,000	1,133	1,266	1,367	1,500
11	Hemmed	417	556	661	800	939	1,044	1,183	1,322	1,427	1,566
12	Hemmed	435	580	689	834	979	1,088	1,233	1,378	1,487	1,632
13	Hemmed	453	604	717	868	1,019	1,132	1,283	1,434	1,547	1,698
14	Hemmed	471	628	745	902	1,059	1,176	1,333	1,490	1,607	1,764
15	Hemmed	489	652	773	936	1,099	1,220	1,383	1,546	1,667	1,830
16	Hemmed	507	676	801	970	1,139	1,264	1,433	1,602	1,727	1,896
17	Hemmed	525	700	829	1,004	1,179	1,308	1,483	1,658	1,787	1,962
18	Hemmed	543	724	857	1,038	1,219	1,352	1,533	1,714	1,847	2,028
19	Hemmed	561	748	885	1,072	1,259	1,396	1,583	1,770	1,907	2,094
20	Hemmed	579	772	913	1,106	1,299	1,440	1,633	1,826	1,967	2,160
21	Hemmed	597	796	941	1,140	1,339	1,484	1,683	1,882	2,027	2,226
22	Hemmed	615	820	969	1,174	1,379	1,528	1,733	1,938	2,087	2,292
23	Hemmed	633	844	997	1,208	1,419	1,572	1,783	1,994	2,147	2,358
24	Hemmed	651	868	1,025	1,242	1,459	1,616	1,833	2,050	2,207	2,424
25	Hemmed	678	904	1,067	1,293	1,519	1,682	1,908	2,134	2,297	2,523
26	Hemmed	696	928	1,095	1,327	1,559	1,726	1,958	2,190	2,357	2,589
27	Hemmed	714	952	1,123	1,361	1,599	1,770	2,008	2,246	2,417	2,655
28	Hemmed	732	976	1,151	1,395	1,639	1,814	2,058	2,302	2,477	2,721
29	Hemmed	750	1,000	1,179	1,429	1,679	1,858	2,108	2,358	2,537	2,787
30	Hemmed	777	1,036	1,221	1,480	1,739	1,924	2,183	2,442	2,627	2,886
31	Hemmed	791	1,054	1,242	1,506	1,769	1,957	2,221	2,484	2,672	2,936
32	Hemmed	809	1,078	1,270	1,540	1,809	2,001	2,271	2,540	2,732	3,002
33	Hemmed	831	1,108	1,305	1,582	1,859	2,056	2,333	2,610	2,807	3,084
34	Hemmed	876	1,168	1,375	1,667	1,959	2,166	2,458	2,750	2,957	3,249
35	Hemmed	921	1,228	1,445	1,752	2,059	2,276	2,583	2,890	3,107	3,414
36	Hemmed	975	1,300	1,529	1,854	2,179	2,408	2,733	3,058	3,287	3,612

RING TOP: 2 Fullness — Unlined

Maximum length 96" with Eurohem (exceptions may apply). Sizes and series numbers beyond what is listed in the charts below are available—please submit these quote requests via fax or email.

Series		Finished Pair or Panel Width									
		36"	48"	60"	72"	84"	96"	108"	120"	132"	144"
07	Eurohem	135	172	221	258	296	344	382	420	468	506
08	Eurohem	147	187	241	281	321	374	415	455	508	548
09	Eurohem	157	199	257	299	341	398	441	483	540	582
10	Eurohem	167	211	273	317	361	422	467	511	572	616
11	Eurohem	177	223	289	335	381	446	493	539	604	650
12	Eurohem	187	235	305	353	401	470	519	567	636	684
13	Eurohem	197	247	321	371	421	494	545	595	668	718
14	Eurohem	207	259	337	389	441	518	571	623	700	752
15	Eurohem	217	271	353	407	461	542	597	651	732	786
16	Eurohem	227	283	369	425	481	566	623	679	764	820
17	Eurohem	237	295	385	443	501	590	649	707	796	854
18	Eurohem	247	307	401	461	521	614	675	735	828	888
19	Eurohem	257	319	417	479	541	638	701	763	860	922
20	Eurohem	267	331	433	497	561	662	727	791	892	956
21	Eurohem	277	343	449	515	581	686	753	819	924	990
22	Eurohem	287	355	465	533	601	710	779	847	956	1,024
23	Eurohem	297	367	481	551	621	734	805	875	988	1,058
24	Eurohem	307	379	497	569	641	758	831	903	1,020	1,092
25	Eurohem	322	397	521	596	671	794	870	945	1,068	1,143
26	Eurohem	332	409	537	614	691	818	896	973	1,100	1,177
27	Eurohem	342	421	553	632	711	842	922	1,001	1,132	1,211
28	Eurohem	352	433	569	650	731	866	948	1,029	1,164	1,245
29	Eurohem	362	445	585	668	751	890	974	1,057	1,196	1,279
30	Eurohem	377	463	609	695	781	926	1,013	1,099	1,244	1,330
31	Eurohem	385	472	621	708	796	944	1,032	1,120	1,268	1,356
32	Eurohem	395	484	637	726	816	968	1,058	1,148	1,300	1,390
33	Eurohem	407	499	657	749	841	998	1,091	1,183	1,340	1,432
34	Eurohem	432	529	697	794	891	1,058	1,156	1,253	1,420	1,517
35	Eurohem	457	559	737	839	941	1,118	1,221	1,323	1,500	1,602
36	Eurohem	487	595	785	893	1,001	1,190	1,299	1,407	1,596	1,704

Maximum length 88" with 4" hem (exceptions may apply).

Series		Finished Pair or Panel Width									
		36"	48"	60"	72"	84"	96"	108"	120"	132"	144"
07	Hemmed	142	182	233	273	313	364	404	444	495	535
08	Hemmed	154	197	253	295	338	394	436	479	535	577
09	Hemmed	164	209	269	313	358	418	462	507	567	611
10	Hemmed	174	221	285	331	378	442	488	535	599	645
11	Hemmed	184	233	301	349	398	466	514	563	631	679
12	Hemmed	194	245	317	367	418	490	540	591	663	713
13	Hemmed	204	257	333	385	438	514	566	619	695	747
14	Hemmed	214	269	349	403	458	538	592	647	727	781
15	Hemmed	224	281	365	421	478	562	618	675	759	815
16	Hemmed	234	293	381	439	498	586	644	703	791	849
17	Hemmed	244	305	397	457	518	610	670	731	823	883
18	Hemmed	254	317	413	475	538	634	696	759	855	917
19	Hemmed	264	329	429	493	558	658	722	787	887	951
20	Hemmed	274	341	445	511	578	682	748	815	919	985
21	Hemmed	284	353	461	529	598	706	774	843	951	1,019
22	Hemmed	294	365	477	547	618	730	800	871	983	1,053
23	Hemmed	304	377	493	565	638	754	826	899	1,015	1,087
24	Hemmed	314	389	509	583	658	778	852	927	1,047	1,121
25	Hemmed	329	407	533	610	688	814	891	969	1,095	1,172
26	Hemmed	339	419	549	628	708	838	917	997	1,127	1,206
27	Hemmed	349	431	565	646	728	862	943	1,025	1,159	1,240
28	Hemmed	359	443	581	664	748	886	969	1,053	1,191	1,274
29	Hemmed	369	455	597	682	768	910	995	1,081	1,223	1,308
30	Hemmed	384	473	621	709	798	946	1,034	1,123	1,271	1,359
31	Hemmed	392	482	633	723	813	964	1,054	1,144	1,295	1,385
32	Hemmed	402	494	649	741	833	988	1,080	1,172	1,327	1,419
33	Hemmed	414	509	669	763	858	1,018	1,112	1,207	1,367	1,461
34	Hemmed	439	539	709	808	908	1,078	1,177	1,277	1,447	1,546
35	Hemmed	464	569	749	853	958	1,138	1,242	1,347	1,527	1,631
36	Hemmed	494	605	797	907	1,018	1,210	1,320	1,431	1,623	1,733

RING TOP: 2 Fullness — Lined (Lining 01000)

Maximum length 96" with Eurohem (exceptions may apply). Sizes and series numbers beyond what is listed in the charts below are available—please submit these quote requests via fax or email.

Series		Finished Pair or Panel Width									
		36"	48"	60"	72"	84"	96"	108"	120"	132"	144"
07	Eurohem	219	275	356	412	468	549	605	661	742	798
08	Eurohem	231	290	376	434	493	579	638	696	782	841
09	Eurohem	241	302	392	452	513	603	664	724	814	875
10	Eurohem	251	314	408	470	533	627	690	752	846	909
11	Eurohem	261	326	424	488	553	651	716	780	878	943
12	Eurohem	271	338	440	506	573	675	742	808	910	977
13	Eurohem	281	350	456	524	593	699	768	836	942	1,011
14	Eurohem	291	362	472	542	613	723	794	864	974	1,045
15	Eurohem	301	374	488	560	633	747	820	892	1,006	1,079
16	Eurohem	311	386	504	578	653	771	846	920	1,038	1,113
17	Eurohem	321	398	520	596	673	795	872	948	1,070	1,147
18	Eurohem	331	410	536	614	693	819	898	976	1,102	1,181
19	Eurohem	341	422	552	632	713	843	924	1,004	1,134	1,215
20	Eurohem	351	434	568	650	733	867	950	1,032	1,166	1,249
21	Eurohem	361	446	584	668	753	891	976	1,060	1,198	1,283
22	Eurohem	371	458	600	686	773	915	1,002	1,088	1,230	1,317
23	Eurohem	381	470	616	704	793	939	1,028	1,116	1,262	1,351
24	Eurohem	391	482	632	722	813	963	1,054	1,144	1,294	1,385
25	Eurohem	406	500	656	749	843	999	1,093	1,186	1,342	1,436
26	Eurohem	416	512	672	767	863	1,023	1,119	1,214	1,374	1,470
27	Eurohem	426	524	688	785	883	1,047	1,145	1,242	1,406	1,504
28	Eurohem	436	536	704	803	903	1,071	1,171	1,270	1,438	1,538
29	Eurohem	446	548	720	821	923	1,095	1,197	1,298	1,470	1,572
30	Eurohem	461	566	744	848	953	1,131	1,236	1,340	1,518	1,623
31	Eurohem	469	575	756	862	968	1,149	1,255	1,361	1,542	1,648
32	Eurohem	479	587	772	880	988	1,173	1,281	1,389	1,574	1,682
33	Eurohem	491	602	792	902	1,013	1,203	1,314	1,424	1,614	1,725
34	Eurohem	516	632	832	947	1,063	1,263	1,379	1,494	1,694	1,810
35	Eurohem	541	662	872	992	1,113	1,323	1,444	1,564	1,774	1,895
36	Eurohem	571	698	920	1,046	1,173	1,395	1,522	1,648	1,870	1,997

Maximum length 88" with 4" hem (exceptions may apply).

Series		Finished Pair or Panel Width									
		36"	48"	60"	72"	84"	96"	108"	120"	132"	144"
07	Hemmed	226	284	368	426	485	568	627	685	769	827
08	Hemmed	238	299	388	449	510	598	659	720	809	870
09	Hemmed	248	311	404	467	530	622	685	748	841	904
10	Hemmed	258	323	420	485	550	646	711	776	873	938
11	Hemmed	268	335	436	503	570	670	737	804	905	972
12	Hemmed	278	347	452	521	590	694	763	832	937	1,006
13	Hemmed	288	359	468	539	610	718	789	860	969	1,040
14	Hemmed	298	371	484	557	630	742	815	888	1,001	1,074
15	Hemmed	308	383	500	575	650	766	841	916	1,033	1,108
16	Hemmed	318	395	516	593	670	790	867	944	1,065	1,142
17	Hemmed	328	407	532	611	690	814	893	972	1,097	1,176
18	Hemmed	338	419	548	629	710	838	919	1,000	1,129	1,210
19	Hemmed	348	431	564	647	730	862	945	1,028	1,161	1,244
20	Hemmed	358	443	580	665	750	886	971	1,056	1,193	1,278
21	Hemmed	368	455	596	683	770	910	997	1,084	1,225	1,312
22	Hemmed	378	467	612	701	790	934	1,023	1,112	1,257	1,346
23	Hemmed	388	479	628	719	810	958	1,049	1,140	1,289	1,380
24	Hemmed	398	491	644	737	830	982	1,075	1,168	1,321	1,414
25	Hemmed	413	509	668	764	860	1,018	1,114	1,210	1,369	1,465
26	Hemmed	423	521	684	782	880	1,042	1,140	1,238	1,401	1,499
27	Hemmed	433	533	700	800	900	1,066	1,166	1,266	1,433	1,533
28	Hemmed	443	545	716	818	920	1,090	1,192	1,294	1,465	1,567
29	Hemmed	453	557	732	836	940	1,114	1,218	1,322	1,497	1,601
30	Hemmed	468	575	756	863	970	1,150	1,257	1,364	1,545	1,652
31	Hemmed	476	584	768	876	985	1,168	1,277	1,385	1,569	1,677
32	Hemmed	486	596	784	894	1,005	1,192	1,303	1,413	1,601	1,711
33	Hemmed	498	611	804	917	1,030	1,222	1,335	1,448	1,641	1,754
34	Hemmed	523	641	844	962	1,080	1,282	1,400	1,518	1,721	1,839
35	Hemmed	548	671	884	1,007	1,130	1,342	1,465	1,588	1,801	1,924
36	Hemmed	578	707	932	1,061	1,190	1,414	1,543	1,672	1,897	2,026

RING TOP: 2.5 Fullness — Unlined

Maximum length 96" with Eurohem (exceptions may apply). Sizes and series numbers beyond what is listed in the charts below are available—please submit these quote requests via fax or email.

Series		Finished Pair or Panel Width									
		36"	48"	60"	72"	84"	96"	108"	120"	132"	144"
07	Eurohem	145	193	231	279	328	365	414	462	500	548
08	Eurohem	160	213	254	307	360	400	454	507	547	600
09	Eurohem	172	229	272	329	386	428	486	543	585	642
10	Eurohem	184	245	290	351	412	456	518	579	623	684
11	Eurohem	196	261	308	373	438	484	550	615	661	726
12	Eurohem	208	277	326	395	464	512	582	651	699	768
13	Eurohem	220	293	344	417	490	540	614	687	737	810
14	Eurohem	232	309	362	439	516	568	646	723	775	852
15	Eurohem	244	325	380	461	542	596	678	759	813	894
16	Eurohem	256	341	398	483	568	624	710	795	851	936
17	Eurohem	268	357	416	505	594	652	742	831	889	978
18	Eurohem	280	373	434	527	620	680	774	867	927	1,020
19	Eurohem	292	389	452	549	646	708	806	903	965	1,062
20	Eurohem	304	405	470	571	672	736	838	939	1,003	1,104
21	Eurohem	316	421	488	593	698	764	870	975	1,041	1,146
22	Eurohem	328	437	506	615	724	792	902	1,011	1,079	1,188
23	Eurohem	340	453	524	637	750	820	934	1,047	1,117	1,230
24	Eurohem	352	469	542	659	776	848	966	1,083	1,155	1,272
25	Eurohem	370	493	569	692	815	890	1,014	1,137	1,212	1,335
26	Eurohem	382	509	587	714	841	918	1,046	1,173	1,250	1,377
27	Eurohem	394	525	605	736	867	946	1,078	1,209	1,288	1,419
28	Eurohem	406	541	623	758	893	974	1,110	1,245	1,326	1,461
29	Eurohem	418	557	641	780	919	1,002	1,142	1,281	1,364	1,503
30	Eurohem	436	581	668	813	958	1,044	1,190	1,335	1,421	1,566
31	Eurohem	445	593	681	829	978	1,065	1,214	1,362	1,450	1,598
32	Eurohem	457	609	699	851	1,004	1,093	1,246	1,398	1,488	1,640
33	Eurohem	472	629	722	879	1,036	1,128	1,286	1,443	1,535	1,692
34	Eurohem	502	669	767	934	1,101	1,198	1,366	1,533	1,630	1,797
35	Eurohem	532	709	812	989	1,166	1,268	1,446	1,623	1,725	1,902
36	Eurohem	568	757	866	1,055	1,244	1,352	1,542	1,731	1,839	2,028

Maximum length 88" with 4" hem (exceptions may apply).

Series		Finished Pair or Panel Width									
		36"	48"	60"	72"	84"	96"	108"	120"	132"	144"
07	Hemmed	152	203	243	294	344	385	435	486	526	577
08	Hemmed	167	223	266	321	377	420	475	531	574	629
09	Hemmed	179	239	284	343	403	448	507	567	612	671
10	Hemmed	191	255	302	365	429	476	539	603	650	713
11	Hemmed	203	271	320	387	455	504	571	639	688	755
12	Hemmed	215	287	338	409	481	532	603	675	726	797
13	Hemmed	227	303	356	431	507	560	635	711	764	839
14	Hemmed	239	319	374	453	533	588	667	747	802	881
15	Hemmed	251	335	392	475	559	616	699	783	840	923
16	Hemmed	263	351	410	497	585	644	731	819	878	965
17	Hemmed	275	367	428	519	611	672	763	855	916	1,007
18	Hemmed	287	383	446	541	637	700	795	891	954	1,049
19	Hemmed	299	399	464	563	663	728	827	927	992	1,091
20	Hemmed	311	415	482	585	689	756	859	963	1,030	1,133
21	Hemmed	323	431	500	607	715	784	891	999	1,068	1,175
22	Hemmed	335	447	518	629	741	812	923	1,035	1,106	1,217
23	Hemmed	347	463	536	651	767	840	955	1,071	1,144	1,259
24	Hemmed	359	479	554	673	793	868	987	1,107	1,182	1,301
25	Hemmed	377	503	581	706	832	910	1,035	1,161	1,239	1,364
26	Hemmed	389	519	599	728	858	938	1,067	1,197	1,277	1,406
27	Hemmed	401	535	617	750	884	966	1,099	1,233	1,315	1,448
28	Hemmed	413	551	635	772	910	994	1,131	1,269	1,353	1,490
29	Hemmed	425	567	653	794	936	1,022	1,163	1,305	1,391	1,532
30	Hemmed	443	591	680	827	975	1,064	1,211	1,359	1,448	1,595
31	Hemmed	452	603	693	844	994	1,085	1,235	1,386	1,476	1,627
32	Hemmed	464	619	711	866	1,020	1,113	1,267	1,422	1,514	1,669
33	Hemmed	479	639	734	893	1,053	1,148	1,307	1,467	1,562	1,721
34	Hemmed	509	679	779	948	1,118	1,218	1,387	1,557	1,657	1,826
35	Hemmed	539	719	824	1,003	1,183	1,288	1,467	1,647	1,752	1,931
36	Hemmed	575	767	878	1,069	1,261	1,372	1,563	1,755	1,866	2,057

RING TOP: 2.5 Fullness — Lined (Lining 01000)

Maximum length 96" with Eurohem (exceptions may apply). Sizes and series numbers beyond what is listed in the charts below are available—please submit these quote requests via fax or email.

Series		Finished Pair or Panel Width									
		36"	48"	60"	72"	84"	96"	108"	120"	132"	144"
07	Eurohem	244	325	381	462	543	599	680	761	817	898
08	Eurohem	259	345	403	489	576	634	720	806	865	951
09	Eurohem	271	361	421	511	602	662	752	842	903	993
10	Eurohem	283	377	439	533	628	690	784	878	941	1,035
11	Eurohem	295	393	457	555	654	718	816	914	979	1,077
12	Eurohem	307	409	475	577	680	746	848	950	1,017	1,119
13	Eurohem	319	425	493	599	706	774	880	986	1,055	1,161
14	Eurohem	331	441	511	621	732	802	912	1,022	1,093	1,203
15	Eurohem	343	457	529	643	758	830	944	1,058	1,131	1,245
16	Eurohem	355	473	547	665	784	858	976	1,094	1,169	1,287
17	Eurohem	367	489	565	687	810	886	1,008	1,130	1,207	1,329
18	Eurohem	379	505	583	709	836	914	1,040	1,166	1,245	1,371
19	Eurohem	391	521	601	731	862	942	1,072	1,202	1,283	1,413
20	Eurohem	403	537	619	753	888	970	1,104	1,238	1,321	1,455
21	Eurohem	415	553	637	775	914	998	1,136	1,274	1,359	1,497
22	Eurohem	427	569	655	797	940	1,026	1,168	1,310	1,397	1,539
23	Eurohem	439	585	673	819	966	1,054	1,200	1,346	1,435	1,581
24	Eurohem	451	601	691	841	992	1,082	1,232	1,382	1,473	1,623
25	Eurohem	469	625	718	874	1,031	1,124	1,280	1,436	1,530	1,686
26	Eurohem	481	641	736	896	1,057	1,152	1,312	1,472	1,568	1,728
27	Eurohem	493	657	754	918	1,083	1,180	1,344	1,508	1,606	1,770
28	Eurohem	505	673	772	940	1,109	1,208	1,376	1,544	1,644	1,812
29	Eurohem	517	689	790	962	1,135	1,236	1,408	1,580	1,682	1,854
30	Eurohem	535	713	817	995	1,174	1,278	1,456	1,634	1,739	1,917
31	Eurohem	544	725	831	1,012	1,193	1,299	1,480	1,661	1,767	1,948
32	Eurohem	556	741	849	1,034	1,219	1,327	1,512	1,697	1,805	1,990
33	Eurohem	571	761	871	1,061	1,252	1,362	1,552	1,742	1,853	2,043
34	Eurohem	601	801	916	1,116	1,317	1,432	1,632	1,832	1,948	2,148
35	Eurohem	631	841	961	1,171	1,382	1,502	1,712	1,922	2,043	2,253
36	Eurohem	667	889	1,015	1,237	1,460	1,586	1,808	2,030	2,157	2,379

Maximum length 88" with 4" hem (exceptions may apply).

Series		Finished Pair or Panel Width									
		36"	48"	60"	72"	84"	96"	108"	120"	132"	144"
07	Hemmed	251	334	393	476	560	618	702	785	844	927
08	Hemmed	266	354	415	504	592	653	742	830	891	980
09	Hemmed	278	370	433	526	618	681	774	866	929	1,022
10	Hemmed	290	386	451	548	644	709	806	902	967	1,064
11	Hemmed	302	402	469	570	670	737	838	938	1,005	1,106
12	Hemmed	314	418	487	592	696	765	870	974	1,043	1,148
13	Hemmed	326	434	505	614	722	793	902	1,010	1,081	1,190
14	Hemmed	338	450	523	636	748	821	934	1,046	1,119	1,232
15	Hemmed	350	466	541	658	774	849	966	1,082	1,157	1,274
16	Hemmed	362	482	559	680	800	877	998	1,118	1,195	1,316
17	Hemmed	374	498	577	702	826	905	1,030	1,154	1,233	1,358
18	Hemmed	386	514	595	724	852	933	1,062	1,190	1,271	1,400
19	Hemmed	398	530	613	746	878	961	1,094	1,226	1,309	1,442
20	Hemmed	410	546	631	768	904	989	1,126	1,262	1,347	1,484
21	Hemmed	422	562	649	790	930	1,017	1,158	1,298	1,385	1,526
22	Hemmed	434	578	667	812	956	1,045	1,190	1,334	1,423	1,568
23	Hemmed	446	594	685	834	982	1,073	1,222	1,370	1,461	1,610
24	Hemmed	458	610	703	856	1,008	1,101	1,254	1,406	1,499	1,652
25	Hemmed	476	634	730	889	1,047	1,143	1,302	1,460	1,556	1,715
26	Hemmed	488	650	748	911	1,073	1,171	1,334	1,496	1,594	1,757
27	Hemmed	500	666	766	933	1,099	1,199	1,366	1,532	1,632	1,799
28	Hemmed	512	682	784	955	1,125	1,227	1,398	1,568	1,670	1,841
29	Hemmed	524	698	802	977	1,151	1,255	1,430	1,604	1,708	1,883
30	Hemmed	542	722	829	1,010	1,190	1,297	1,478	1,658	1,765	1,946
31	Hemmed	551	734	843	1,026	1,210	1,318	1,502	1,685	1,794	1,977
32	Hemmed	563	750	861	1,048	1,236	1,346	1,534	1,721	1,832	2,019
33	Hemmed	578	770	883	1,076	1,268	1,381	1,574	1,766	1,879	2,072
34	Hemmed	608	810	928	1,131	1,333	1,451	1,654	1,856	1,974	2,177
35	Hemmed	638	850	973	1,186	1,398	1,521	1,734	1,946	2,069	2,282
36	Hemmed	674	898	1,027	1,252	1,476	1,605	1,830	2,054	2,183	2,408

RING TOP: 3 Fullness — Unlined

Maximum length 96" with Eurohem (exceptions may apply). Sizes and series numbers beyond what is listed in the charts below are available—please submit these quote requests via fax or email.

Series		Finished Pair or Panel Width									
		36"	48"	60"	72"	84"	96"	108"	120"	132"	144"
07	Eurohem	156	204	252	300	349	397	445	493	542	590
08	Eurohem	173	226	280	333	386	439	493	546	599	652
09	Eurohem	187	244	302	359	416	473	531	588	645	702
10	Eurohem	201	262	324	385	446	507	569	630	691	752
11	Eurohem	215	280	346	411	476	541	607	672	737	802
12	Eurohem	229	298	368	437	506	575	645	714	783	852
13	Eurohem	243	316	390	463	536	609	683	756	829	902
14	Eurohem	257	334	412	489	566	643	721	798	875	952
15	Eurohem	271	352	434	515	596	677	759	840	921	1,002
16	Eurohem	285	370	456	541	626	711	797	882	967	1,052
17	Eurohem	299	388	478	567	656	745	835	924	1,013	1,102
18	Eurohem	313	406	500	593	686	779	873	966	1,059	1,152
19	Eurohem	327	424	522	619	716	813	911	1,008	1,105	1,202
20	Eurohem	341	442	544	645	746	847	949	1,050	1,151	1,252
21	Eurohem	355	460	566	671	776	881	987	1,092	1,197	1,302
22	Eurohem	369	478	588	697	806	915	1,025	1,134	1,243	1,352
23	Eurohem	383	496	610	723	836	949	1,063	1,176	1,289	1,402
24	Eurohem	397	514	632	749	866	983	1,101	1,218	1,335	1,452
25	Eurohem	418	541	665	788	911	1,034	1,158	1,281	1,404	1,527
26	Eurohem	432	559	687	814	941	1,068	1,196	1,323	1,450	1,577
27	Eurohem	446	577	709	840	971	1,102	1,234	1,365	1,496	1,627
28	Eurohem	460	595	731	866	1,001	1,136	1,272	1,407	1,542	1,677
29	Eurohem	474	613	753	892	1,031	1,170	1,310	1,449	1,588	1,727
30	Eurohem	495	640	786	931	1,076	1,221	1,367	1,512	1,657	1,802
31	Eurohem	506	654	802	950	1,099	1,247	1,395	1,543	1,692	1,840
32	Eurohem	520	672	824	976	1,129	1,281	1,433	1,585	1,738	1,890
33	Eurohem	537	694	852	1,009	1,166	1,323	1,481	1,638	1,795	1,952
34	Eurohem	572	739	907	1,074	1,241	1,408	1,576	1,743	1,910	2,077
35	Eurohem	607	784	962	1,139	1,316	1,493	1,671	1,848	2,025	2,202
36	Eurohem	649	838	1,028	1,217	1,406	1,595	1,785	1,974	2,163	2,352

Maximum length 88" with 4" hem (exceptions may apply).

Series		Finished Pair or Panel Width									
		36"	48"	60"	72"	84"	96"	108"	120"	132"	144"
07	Hemmed	163	214	264	315	365	416	467	517	568	619
08	Hemmed	180	236	292	347	403	459	514	570	626	681
09	Hemmed	194	254	314	373	433	493	552	612	672	731
10	Hemmed	208	272	336	399	463	527	590	654	718	781
11	Hemmed	222	290	358	425	493	561	628	696	764	831
12	Hemmed	236	308	380	451	523	595	666	738	810	881
13	Hemmed	250	326	402	477	553	629	704	780	856	931
14	Hemmed	264	344	424	503	583	663	742	822	902	981
15	Hemmed	278	362	446	529	613	697	780	864	948	1,031
16	Hemmed	292	380	468	555	643	731	818	906	994	1,081
17	Hemmed	306	398	490	581	673	765	856	948	1,040	1,131
18	Hemmed	320	416	512	607	703	799	894	990	1,086	1,181
19	Hemmed	334	434	534	633	733	833	932	1,032	1,132	1,231
20	Hemmed	348	452	556	659	763	867	970	1,074	1,178	1,281
21	Hemmed	362	470	578	685	793	901	1,008	1,116	1,224	1,331
22	Hemmed	376	488	600	711	823	935	1,046	1,158	1,270	1,381
23	Hemmed	390	506	622	737	853	969	1,084	1,200	1,316	1,431
24	Hemmed	404	524	644	763	883	1,003	1,122	1,242	1,362	1,481
25	Hemmed	425	551	677	802	928	1,054	1,179	1,305	1,431	1,556
26	Hemmed	439	569	699	828	958	1,088	1,217	1,347	1,477	1,606
27	Hemmed	453	587	721	854	988	1,122	1,255	1,389	1,523	1,656
28	Hemmed	467	605	743	880	1,018	1,156	1,293	1,431	1,569	1,706
29	Hemmed	481	623	765	906	1,048	1,190	1,331	1,473	1,615	1,756
30	Hemmed	502	650	798	945	1,093	1,241	1,388	1,536	1,684	1,831
31	Hemmed	513	664	814	965	1,115	1,266	1,417	1,567	1,718	1,869
32	Hemmed	527	682	836	991	1,145	1,300	1,455	1,609	1,764	1,919
33	Hemmed	544	704	864	1,023	1,183	1,343	1,502	1,662	1,822	1,981
34	Hemmed	579	749	919	1,088	1,258	1,428	1,597	1,767	1,937	2,106
35	Hemmed	614	794	974	1,153	1,333	1,513	1,692	1,872	2,052	2,231
36	Hemmed	656	848	1,040	1,231	1,423	1,615	1,806	1,998	2,190	2,381

RING TOP: 3 Fullness — Lined (Lining 01000)

Maximum length 96" with Eurohem (exceptions may apply). Sizes and series numbers beyond what is listed in the charts below are available—please submit these quote requests via fax or email.

Series		Finished Pair or Panel Width									
		36"	48"	60"	72"	84"	96"	108"	120"	132"	144"
07	Eurohem	269	350	431	512	593	674	755	836	917	998
08	Eurohem	286	372	458	544	631	717	803	889	975	1,061
09	Eurohem	300	390	480	570	661	751	841	931	1,021	1,111
10	Eurohem	314	408	502	596	691	785	879	973	1,067	1,161
11	Eurohem	328	426	524	622	721	819	917	1,015	1,113	1,211
12	Eurohem	342	444	546	648	751	853	955	1,057	1,159	1,261
13	Eurohem	356	462	568	674	781	887	993	1,099	1,205	1,311
14	Eurohem	370	480	590	700	811	921	1,031	1,141	1,251	1,361
15	Eurohem	384	498	612	726	841	955	1,069	1,183	1,297	1,411
16	Eurohem	398	516	634	752	871	989	1,107	1,225	1,343	1,461
17	Eurohem	412	534	656	778	901	1,023	1,145	1,267	1,389	1,511
18	Eurohem	426	552	678	804	931	1,057	1,183	1,309	1,435	1,561
19	Eurohem	440	570	700	830	961	1,091	1,221	1,351	1,481	1,611
20	Eurohem	454	588	722	856	991	1,125	1,259	1,393	1,527	1,661
21	Eurohem	468	606	744	882	1,021	1,159	1,297	1,435	1,573	1,711
22	Eurohem	482	624	766	908	1,051	1,193	1,335	1,477	1,619	1,761
23	Eurohem	496	642	788	934	1,081	1,227	1,373	1,519	1,665	1,811
24	Eurohem	510	660	810	960	1,111	1,261	1,411	1,561	1,711	1,861
25	Eurohem	531	687	843	999	1,156	1,312	1,468	1,624	1,780	1,936
26	Eurohem	545	705	865	1,025	1,186	1,346	1,506	1,666	1,826	1,986
27	Eurohem	559	723	887	1,051	1,216	1,380	1,544	1,708	1,872	2,036
28	Eurohem	573	741	909	1,077	1,246	1,414	1,582	1,750	1,918	2,086
29	Eurohem	587	759	931	1,103	1,276	1,448	1,620	1,792	1,964	2,136
30	Eurohem	608	786	964	1,142	1,321	1,499	1,677	1,855	2,033	2,211
31	Eurohem	619	800	981	1,162	1,343	1,524	1,705	1,886	2,067	2,248
32	Eurohem	633	818	1,003	1,188	1,373	1,558	1,743	1,928	2,113	2,298
33	Eurohem	650	840	1,030	1,220	1,411	1,601	1,791	1,981	2,171	2,361
34	Eurohem	685	885	1,085	1,285	1,486	1,686	1,886	2,086	2,286	2,486
35	Eurohem	720	930	1,140	1,350	1,561	1,771	1,981	2,191	2,401	2,611
36	Eurohem	762	984	1,206	1,428	1,651	1,873	2,095	2,317	2,539	2,761

Maximum length 88" with 4" hem (exceptions may apply).

Series		Finished Pair or Panel Width									
		36"	48"	60"	72"	84"	96"	108"	120"	132"	144"
07	Hemmed	276	359	443	526	610	693	777	860	944	1,027
08	Hemmed	293	382	470	559	647	736	824	913	1,001	1,090
09	Hemmed	307	400	492	585	677	770	862	955	1,047	1,140
10	Hemmed	321	418	514	611	707	804	900	997	1,093	1,190
11	Hemmed	335	436	536	637	737	838	938	1,039	1,139	1,240
12	Hemmed	349	454	558	663	767	872	976	1,081	1,185	1,290
13	Hemmed	363	472	580	689	797	906	1,014	1,123	1,231	1,340
14	Hemmed	377	490	602	715	827	940	1,052	1,165	1,277	1,390
15	Hemmed	391	508	624	741	857	974	1,090	1,207	1,323	1,440
16	Hemmed	405	526	646	767	887	1,008	1,128	1,249	1,369	1,490
17	Hemmed	419	544	668	793	917	1,042	1,166	1,291	1,415	1,540
18	Hemmed	433	562	690	819	947	1,076	1,204	1,333	1,461	1,590
19	Hemmed	447	580	712	845	977	1,110	1,242	1,375	1,507	1,640
20	Hemmed	461	598	734	871	1,007	1,144	1,280	1,417	1,553	1,690
21	Hemmed	475	616	756	897	1,037	1,178	1,318	1,459	1,599	1,740
22	Hemmed	489	634	778	923	1,067	1,212	1,356	1,501	1,645	1,790
23	Hemmed	503	652	800	949	1,097	1,246	1,394	1,543	1,691	1,840
24	Hemmed	517	670	822	975	1,127	1,280	1,432	1,585	1,737	1,890
25	Hemmed	538	697	855	1,014	1,172	1,331	1,489	1,648	1,806	1,965
26	Hemmed	552	715	877	1,040	1,202	1,365	1,527	1,690	1,852	2,015
27	Hemmed	566	733	899	1,066	1,232	1,399	1,565	1,732	1,898	2,065
28	Hemmed	580	751	921	1,092	1,262	1,433	1,603	1,774	1,944	2,115
29	Hemmed	594	769	943	1,118	1,292	1,467	1,641	1,816	1,990	2,165
30	Hemmed	615	796	976	1,157	1,337	1,518	1,698	1,879	2,059	2,240
31	Hemmed	626	809	993	1,176	1,360	1,543	1,727	1,910	2,094	2,277
32	Hemmed	640	827	1,015	1,202	1,390	1,577	1,765	1,952	2,140	2,327
33	Hemmed	657	850	1,042	1,235	1,427	1,620	1,812	2,005	2,197	2,390
34	Hemmed	692	895	1,097	1,300	1,502	1,705	1,907	2,110	2,312	2,515
35	Hemmed	727	940	1,152	1,365	1,577	1,790	2,002	2,215	2,427	2,640
36	Hemmed	769	994	1,218	1,443	1,667	1,892	2,116	2,341	2,565	2,790

RING TOP: 4 Fullness — Unlined

Maximum length 96" with Eurohem (exceptions may apply). Sizes and series numbers beyond what is listed in the charts below are available—please submit these quote requests via fax or email.

Series		Finished Pair or Panel Width									
		36"	48"	60"	72"	84"	96"	108"	120"	132"	144"
07	Eurohem	177	235	284	342	401	449	508	567	615	674
08	Eurohem	199	265	319	385	451	504	571	637	690	756
09	Eurohem	217	289	347	419	491	548	621	693	750	822
10	Eurohem	235	313	375	453	531	592	671	749	810	888
11	Eurohem	253	337	403	487	571	636	721	805	870	954
12	Eurohem	271	361	431	521	611	680	771	861	930	1,020
13	Eurohem	289	385	459	555	651	724	821	917	990	1,086
14	Eurohem	307	409	487	589	691	768	871	973	1,050	1,152
15	Eurohem	325	433	515	623	731	812	921	1,029	1,110	1,218
16	Eurohem	343	457	543	657	771	856	971	1,085	1,170	1,284
17	Eurohem	361	481	571	691	811	900	1,021	1,141	1,230	1,350
18	Eurohem	379	505	599	725	851	944	1,071	1,197	1,290	1,416
19	Eurohem	397	529	627	759	891	988	1,121	1,253	1,350	1,482
20	Eurohem	415	553	655	793	931	1,032	1,171	1,309	1,410	1,548
21	Eurohem	433	577	683	827	971	1,076	1,221	1,365	1,470	1,614
22	Eurohem	451	601	711	861	1,011	1,120	1,271	1,421	1,530	1,680
23	Eurohem	469	625	739	895	1,051	1,164	1,321	1,477	1,590	1,746
24	Eurohem	487	649	767	929	1,091	1,208	1,371	1,533	1,650	1,812
25	Eurohem	514	685	809	980	1,151	1,274	1,446	1,617	1,740	1,911
26	Eurohem	532	709	837	1,014	1,191	1,318	1,496	1,673	1,800	1,977
27	Eurohem	550	733	865	1,048	1,231	1,362	1,546	1,729	1,860	2,043
28	Eurohem	568	757	893	1,082	1,271	1,406	1,596	1,785	1,920	2,109
29	Eurohem	586	781	921	1,116	1,311	1,450	1,646	1,841	1,980	2,175
30	Eurohem	613	817	963	1,167	1,371	1,516	1,721	1,925	2,070	2,274
31	Eurohem	627	835	984	1,192	1,401	1,549	1,758	1,967	2,115	2,324
32	Eurohem	645	859	1,012	1,226	1,441	1,593	1,808	2,023	2,175	2,390
33	Eurohem	667	889	1,047	1,269	1,491	1,648	1,871	2,093	2,250	2,472
34	Eurohem	712	949	1,117	1,354	1,591	1,758	1,996	2,233	2,400	2,637
35	Eurohem	757	1,009	1,187	1,439	1,691	1,868	2,121	2,373	2,550	2,802
36	Eurohem	811	1,081	1,271	1,541	1,811	2,000	2,271	2,541	2,730	3,000

Maximum length 88" with 4" hem (exceptions may apply).

Series		Finished Pair or Panel Width									
		36"	48"	60"	72"	84"	96"	108"	120"	132"	144"
07	Hemmed	184	245	296	357	418	469	530	591	642	703
08	Hemmed	206	275	331	399	468	524	592	661	717	785
09	Hemmed	224	299	359	433	508	568	642	717	777	851
10	Hemmed	242	323	387	467	548	612	692	773	837	917
11	Hemmed	260	347	415	501	588	656	742	829	897	983
12	Hemmed	278	371	443	535	628	700	792	885	957	1,049
13	Hemmed	296	395	471	569	668	744	842	941	1,017	1,115
14	Hemmed	314	419	499	603	708	788	892	997	1,077	1,181
15	Hemmed	332	443	527	637	748	832	942	1,053	1,137	1,247
16	Hemmed	350	467	555	671	788	876	992	1,109	1,197	1,313
17	Hemmed	368	491	583	705	828	920	1,042	1,165	1,257	1,379
18	Hemmed	386	515	611	739	868	964	1,092	1,221	1,317	1,445
19	Hemmed	404	539	639	773	908	1,008	1,142	1,277	1,377	1,511
20	Hemmed	422	563	667	807	948	1,052	1,192	1,333	1,437	1,577
21	Hemmed	440	587	695	841	988	1,096	1,242	1,389	1,497	1,643
22	Hemmed	458	611	723	875	1,028	1,140	1,292	1,445	1,557	1,709
23	Hemmed	476	635	751	909	1,068	1,184	1,342	1,501	1,617	1,775
24	Hemmed	494	659	779	943	1,108	1,228	1,392	1,557	1,677	1,841
25	Hemmed	521	695	821	994	1,168	1,294	1,467	1,641	1,767	1,940
26	Hemmed	539	719	849	1,028	1,208	1,338	1,517	1,697	1,827	2,006
27	Hemmed	557	743	877	1,062	1,248	1,382	1,567	1,753	1,887	2,072
28	Hemmed	575	767	905	1,096	1,288	1,426	1,617	1,809	1,947	2,138
29	Hemmed	593	791	933	1,130	1,328	1,470	1,667	1,865	2,007	2,204
30	Hemmed	620	827	975	1,181	1,388	1,536	1,742	1,949	2,097	2,303
31	Hemmed	634	845	996	1,207	1,418	1,569	1,780	1,991	2,142	2,353
32	Hemmed	652	869	1,024	1,241	1,458	1,613	1,830	2,047	2,202	2,419
33	Hemmed	674	899	1,059	1,283	1,508	1,668	1,892	2,117	2,277	2,501
34	Hemmed	719	959	1,129	1,368	1,608	1,778	2,017	2,257	2,427	2,666
35	Hemmed	764	1,019	1,199	1,453	1,708	1,888	2,142	2,397	2,577	2,831
36	Hemmed	818	1,091	1,283	1,555	1,828	2,020	2,292	2,565	2,757	3,029

RING TOP: 4 Fullness — Lined (Lining 01000)

Maximum length 96" with Eurohem (exceptions may apply). Sizes and series numbers beyond what is listed in the charts below are available—please submit these quote requests via fax or email.

Series		Finished Pair or Panel Width									
		36"	48"	60"	72"	84"	96"	108"	120"	132"	144"
07	Eurohem	319	425	506	612	718	799	905	1,011	1,092	1,198
08	Eurohem	341	455	541	654	768	854	968	1,081	1,167	1,281
09	Eurohem	359	479	569	688	808	898	1,018	1,137	1,227	1,347
10	Eurohem	377	503	597	722	848	942	1,068	1,193	1,287	1,413
11	Eurohem	395	527	625	756	888	986	1,118	1,249	1,347	1,479
12	Eurohem	413	551	653	790	928	1,030	1,168	1,305	1,407	1,545
13	Eurohem	431	575	681	824	968	1,074	1,218	1,361	1,467	1,611
14	Eurohem	449	599	709	858	1,008	1,118	1,268	1,417	1,527	1,677
15	Eurohem	467	623	737	892	1,048	1,162	1,318	1,473	1,587	1,743
16	Eurohem	485	647	765	926	1,088	1,206	1,368	1,529	1,647	1,809
17	Eurohem	503	671	793	960	1,128	1,250	1,418	1,585	1,707	1,875
18	Eurohem	521	695	821	994	1,168	1,294	1,468	1,641	1,767	1,941
19	Eurohem	539	719	849	1,028	1,208	1,338	1,518	1,697	1,827	2,007
20	Eurohem	557	743	877	1,062	1,248	1,382	1,568	1,753	1,887	2,073
21	Eurohem	575	767	905	1,096	1,288	1,426	1,618	1,809	1,947	2,139
22	Eurohem	593	791	933	1,130	1,328	1,470	1,668	1,865	2,007	2,205
23	Eurohem	611	815	961	1,164	1,368	1,514	1,718	1,921	2,067	2,271
24	Eurohem	629	839	989	1,198	1,408	1,558	1,768	1,977	2,127	2,337
25	Eurohem	656	875	1,031	1,249	1,468	1,624	1,843	2,061	2,217	2,436
26	Eurohem	674	899	1,059	1,283	1,508	1,668	1,893	2,117	2,277	2,502
27	Eurohem	692	923	1,087	1,317	1,548	1,712	1,943	2,173	2,337	2,568
28	Eurohem	710	947	1,115	1,351	1,588	1,756	1,993	2,229	2,397	2,634
29	Eurohem	728	971	1,143	1,385	1,628	1,800	2,043	2,285	2,457	2,700
30	Eurohem	755	1,007	1,185	1,436	1,688	1,866	2,118	2,369	2,547	2,799
31	Eurohem	769	1,025	1,206	1,462	1,718	1,899	2,155	2,411	2,592	2,848
32	Eurohem	787	1,049	1,234	1,496	1,758	1,943	2,205	2,467	2,652	2,914
33	Eurohem	809	1,079	1,269	1,538	1,808	1,998	2,268	2,537	2,727	2,997
34	Eurohem	854	1,139	1,339	1,623	1,908	2,108	2,393	2,677	2,877	3,162
35	Eurohem	899	1,199	1,409	1,708	2,008	2,218	2,518	2,817	3,027	3,327
36	Eurohem	953	1,271	1,493	1,810	2,128	2,350	2,668	2,985	3,207	3,525

Maximum length 88" with 4" hem (exceptions may apply).

Series		Finished Pair or Panel Width									
		36"	48"	60"	72"	84"	96"	108"	120"	132"	144"
07	Hemmed	326	434	518	626	735	818	927	1,035	1,119	1,227
08	Hemmed	348	464	553	669	785	873	989	1,105	1,194	1,310
09	Hemmed	366	488	581	703	825	917	1,039	1,161	1,254	1,376
10	Hemmed	384	512	609	737	865	961	1,089	1,217	1,314	1,442
11	Hemmed	402	536	637	771	905	1,005	1,139	1,273	1,374	1,508
12	Hemmed	420	560	665	805	945	1,049	1,189	1,329	1,434	1,574
13	Hemmed	438	584	693	839	985	1,093	1,239	1,385	1,494	1,640
14	Hemmed	456	608	721	873	1,025	1,137	1,289	1,441	1,554	1,706
15	Hemmed	474	632	749	907	1,065	1,181	1,339	1,497	1,614	1,772
16	Hemmed	492	656	777	941	1,105	1,225	1,389	1,553	1,674	1,838
17	Hemmed	510	680	805	975	1,145	1,269	1,439	1,609	1,734	1,904
18	Hemmed	528	704	833	1,009	1,185	1,313	1,489	1,665	1,794	1,970
19	Hemmed	546	728	861	1,043	1,225	1,357	1,539	1,721	1,854	2,036
20	Hemmed	564	752	889	1,077	1,265	1,401	1,589	1,777	1,914	2,102
21	Hemmed	582	776	917	1,111	1,305	1,445	1,639	1,833	1,974	2,168
22	Hemmed	600	800	945	1,145	1,345	1,489	1,689	1,889	2,034	2,234
23	Hemmed	618	824	973	1,179	1,385	1,533	1,739	1,945	2,094	2,300
24	Hemmed	636	848	1,001	1,213	1,425	1,577	1,789	2,001	2,154	2,366
25	Hemmed	663	884	1,043	1,264	1,485	1,643	1,864	2,085	2,244	2,465
26	Hemmed	681	908	1,071	1,298	1,525	1,687	1,914	2,141	2,304	2,531
27	Hemmed	699	932	1,099	1,332	1,565	1,731	1,964	2,197	2,364	2,597
28	Hemmed	717	956	1,127	1,366	1,605	1,775	2,014	2,253	2,424	2,663
29	Hemmed	735	980	1,155	1,400	1,645	1,819	2,064	2,309	2,484	2,729
30	Hemmed	762	1,016	1,197	1,451	1,705	1,885	2,139	2,393	2,574	2,828
31	Hemmed	776	1,034	1,218	1,476	1,735	1,918	2,177	2,435	2,619	2,877
32	Hemmed	794	1,058	1,246	1,510	1,775	1,962	2,227	2,491	2,679	2,943
33	Hemmed	816	1,088	1,281	1,553	1,825	2,017	2,289	2,561	2,754	3,026
34	Hemmed	861	1,148	1,351	1,638	1,925	2,127	2,414	2,701	2,904	3,191
35	Hemmed	906	1,208	1,421	1,723	2,025	2,237	2,539	2,841	3,054	3,356
36	Hemmed	960	1,280	1,505	1,825	2,145	2,369	2,689	3,009	3,234	3,554

ROD POCKET: Single — 2 Fullness — Unlined

Maximum length 109" with Eurohem (exceptions may apply). Sizes and series numbers beyond what is listed in the charts below are available—please submit these quote requests via fax or email.

Series		Finished Pair or Panel Width									
		36"	48"	60"	72"	84"	96"	108"	120"	132"	144"
07	Eurohem	120	136	174	211	227	264	301	318	355	392
08	Eurohem	135	151	194	236	252	294	336	353	395	437
09	Eurohem	147	163	210	256	272	318	364	381	427	473
10	Eurohem	159	175	226	276	292	342	392	409	459	509
11	Eurohem	171	187	242	296	312	366	420	437	491	545
12	Eurohem	183	199	258	316	332	390	448	465	523	581
13	Eurohem	195	211	274	336	352	414	476	493	555	617
14	Eurohem	207	223	290	356	372	438	504	521	587	653
15	Eurohem	219	235	306	376	392	462	532	549	619	689
16	Eurohem	231	247	322	396	412	486	560	577	651	725
17	Eurohem	243	259	338	416	432	510	588	605	683	761
18	Eurohem	255	271	354	436	452	534	616	633	715	797
19	Eurohem	267	283	370	456	472	558	644	661	747	833
20	Eurohem	279	295	386	476	492	582	672	689	779	869
21	Eurohem	291	307	402	496	512	606	700	717	811	905
22	Eurohem	303	319	418	516	532	630	728	745	843	941
23	Eurohem	315	331	434	536	552	654	756	773	875	977
24	Eurohem	327	343	450	556	572	678	784	801	907	1,013
25	Eurohem	345	361	474	586	602	714	826	843	955	1,067
26	Eurohem	357	373	490	606	622	738	854	871	987	1,103
27	Eurohem	369	385	506	626	642	762	882	899	1,019	1,139
28	Eurohem	381	397	522	646	662	786	910	927	1,051	1,175
29	Eurohem	393	409	538	666	682	810	938	955	1,083	1,211
30	Eurohem	411	427	562	696	712	846	980	997	1,131	1,265
31	Eurohem	420	436	574	711	727	864	1,001	1,018	1,155	1,292
32	Eurohem	432	448	590	731	747	888	1,029	1,046	1,187	1,328
33	Eurohem	447	463	610	756	772	918	1,064	1,081	1,227	1,373
34	Eurohem	477	493	650	806	822	978	1,134	1,151	1,307	1,463
35	Eurohem	507	523	690	856	872	1,038	1,204	1,221	1,387	1,553
36	Eurohem	543	559	738	916	932	1,110	1,288	1,305	1,483	1,661

Maximum length 101" with 4" hem (exceptions may apply).

Series		Finished Pair or Panel Width									
		36"	48"	60"	72"	84"	96"	108"	120"	132"	144"
07	Hemmed	131	150	190	230	249	290	330	349	389	429
08	Hemmed	146	165	210	255	274	320	365	384	429	474
09	Hemmed	158	177	226	275	294	344	393	412	461	510
10	Hemmed	170	189	242	295	314	368	421	440	493	546
11	Hemmed	182	201	258	315	334	392	449	468	525	582
12	Hemmed	194	213	274	335	354	416	477	496	557	618
13	Hemmed	206	225	290	355	374	440	505	524	589	654
14	Hemmed	218	237	306	375	394	464	533	552	621	690
15	Hemmed	230	249	322	395	414	488	561	580	653	726
16	Hemmed	242	261	338	415	434	512	589	608	685	762
17	Hemmed	254	273	354	435	454	536	617	636	717	798
18	Hemmed	266	285	370	455	474	560	645	664	749	834
19	Hemmed	278	297	386	475	494	584	673	692	781	870
20	Hemmed	290	309	402	495	514	608	701	720	813	906
21	Hemmed	302	321	418	515	534	632	729	748	845	942
22	Hemmed	314	333	434	535	554	656	757	776	877	978
23	Hemmed	326	345	450	555	574	680	785	804	909	1,014
24	Hemmed	338	357	466	575	594	704	813	832	941	1,050
25	Hemmed	356	375	490	605	624	740	855	874	989	1,104
26	Hemmed	368	387	506	625	644	764	883	902	1,021	1,140
27	Hemmed	380	399	522	645	664	788	911	930	1,053	1,176
28	Hemmed	392	411	538	665	684	812	939	958	1,085	1,212
29	Hemmed	404	423	554	685	704	836	967	986	1,117	1,248
30	Hemmed	422	441	578	715	734	872	1,009	1,028	1,165	1,302
31	Hemmed	431	450	590	730	749	890	1,030	1,049	1,189	1,329
32	Hemmed	443	462	606	750	769	914	1,058	1,077	1,221	1,365
33	Hemmed	458	477	626	775	794	944	1,093	1,112	1,261	1,410
34	Hemmed	488	507	666	825	844	1,004	1,163	1,182	1,341	1,500
35	Hemmed	518	537	706	875	894	1,064	1,233	1,252	1,421	1,590
36	Hemmed	554	573	754	935	954	1,136	1,317	1,336	1,517	1,698

ROD POCKET: Single — 2 Fullness — Lined (Lining 01000)

Maximum length 109" with Eurohem (exceptions may apply). Sizes and series numbers beyond what is listed in the charts below are available—please submit these quote requests via fax or email.

Series		Finished Pair or Panel Width									
		36"	48"	60"	72"	84"	96"	108"	120"	132"	144"
07	Eurohem	220	240	309	379	399	469	539	558	628	698
08	Eurohem	235	255	329	404	424	499	574	593	668	743
09	Eurohem	247	267	345	424	444	523	602	621	700	779
10	Eurohem	259	279	361	444	464	547	630	649	732	815
11	Eurohem	271	291	377	464	484	571	658	677	764	851
12	Eurohem	283	303	393	484	504	595	686	705	796	887
13	Eurohem	295	315	409	504	524	619	714	733	828	923
14	Eurohem	307	327	425	524	544	643	742	761	860	959
15	Eurohem	319	339	441	544	564	667	770	789	892	995
16	Eurohem	331	351	457	564	584	691	798	817	924	1,031
17	Eurohem	343	363	473	584	604	715	826	845	956	1,067
18	Eurohem	355	375	489	604	624	739	854	873	988	1,103
19	Eurohem	367	387	505	624	644	763	882	901	1,020	1,139
20	Eurohem	379	399	521	644	664	787	910	929	1,052	1,175
21	Eurohem	391	411	537	664	684	811	938	957	1,084	1,211
22	Eurohem	403	423	553	684	704	835	966	985	1,116	1,247
23	Eurohem	415	435	569	704	724	859	994	1,013	1,148	1,283
24	Eurohem	427	447	585	724	744	883	1,022	1,041	1,180	1,319
25	Eurohem	445	465	609	754	774	919	1,064	1,083	1,228	1,373
26	Eurohem	457	477	625	774	794	943	1,092	1,111	1,260	1,409
27	Eurohem	469	489	641	794	814	967	1,120	1,139	1,292	1,445
28	Eurohem	481	501	657	814	834	991	1,148	1,167	1,324	1,481
29	Eurohem	493	513	673	834	854	1,015	1,176	1,195	1,356	1,517
30	Eurohem	511	531	697	864	884	1,051	1,218	1,237	1,404	1,571
31	Eurohem	520	540	709	879	899	1,069	1,239	1,258	1,428	1,598
32	Eurohem	532	552	725	899	919	1,093	1,267	1,286	1,460	1,634
33	Eurohem	547	567	745	924	944	1,123	1,302	1,321	1,500	1,679
34	Eurohem	577	597	785	974	994	1,183	1,372	1,391	1,580	1,769
35	Eurohem	607	627	825	1,024	1,044	1,243	1,442	1,461	1,660	1,859
36	Eurohem	643	663	873	1,084	1,104	1,315	1,526	1,545	1,756	1,967

Maximum length 101" with 4" hem (exceptions may apply).

Series		Finished Pair or Panel Width									
		36"	48"	60"	72"	84"	96"	108"	120"	132"	144"
07	Hemmed	230	252	325	397	420	493	565	588	660	733
08	Hemmed	245	267	345	422	445	523	600	623	700	778
09	Hemmed	257	279	361	442	465	547	628	651	732	814
10	Hemmed	269	291	377	462	485	571	656	679	764	850
11	Hemmed	281	303	393	482	505	595	684	707	796	886
12	Hemmed	293	315	409	502	525	619	712	735	828	922
13	Hemmed	305	327	425	522	545	643	740	763	860	958
14	Hemmed	317	339	441	542	565	667	768	791	892	994
15	Hemmed	329	351	457	562	585	691	796	819	924	1,030
16	Hemmed	341	363	473	582	605	715	824	847	956	1,066
17	Hemmed	353	375	489	602	625	739	852	875	988	1,102
18	Hemmed	365	387	505	622	645	763	880	903	1,020	1,138
19	Hemmed	377	399	521	642	665	787	908	931	1,052	1,174
20	Hemmed	389	411	537	662	685	811	936	959	1,084	1,210
21	Hemmed	401	423	553	682	705	835	964	987	1,116	1,246
22	Hemmed	413	435	569	702	725	859	992	1,015	1,148	1,282
23	Hemmed	425	447	585	722	745	883	1,020	1,043	1,180	1,318
24	Hemmed	437	459	601	742	765	907	1,048	1,071	1,212	1,354
25	Hemmed	455	477	625	772	795	943	1,090	1,113	1,260	1,408
26	Hemmed	467	489	641	792	815	967	1,118	1,141	1,292	1,444
27	Hemmed	479	501	657	812	835	991	1,146	1,169	1,324	1,480
28	Hemmed	491	513	673	832	855	1,015	1,174	1,197	1,356	1,516
29	Hemmed	503	525	689	852	875	1,039	1,202	1,225	1,388	1,552
30	Hemmed	521	543	713	882	905	1,075	1,244	1,267	1,436	1,606
31	Hemmed	530	552	725	897	920	1,093	1,265	1,288	1,460	1,633
32	Hemmed	542	564	741	917	940	1,117	1,293	1,316	1,492	1,669
33	Hemmed	557	579	761	942	965	1,147	1,328	1,351	1,532	1,714
34	Hemmed	587	609	801	992	1,015	1,207	1,398	1,421	1,612	1,804
35	Hemmed	617	639	841	1,042	1,065	1,267	1,468	1,491	1,692	1,894
36	Hemmed	653	675	889	1,102	1,125	1,339	1,552	1,575	1,788	2,002

ROD POCKET: Single — 2.5 Fullness — Unlined

Maximum length 109" with Eurohem (exceptions may apply). Sizes and series numbers beyond what is listed in the charts below are available—please submit these quote requests via fax or email.

Series		Finished Pair or Panel Width									
		36"	48"	60"	72"	84"	96"	108"	120"	132"	144"
07	Eurohem	136	174	219	256	301	318	363	400	445	483
08	Eurohem	151	194	244	286	336	353	403	445	495	538
09	Eurohem	163	210	264	310	364	381	435	481	535	582
10	Eurohem	175	226	284	334	392	409	467	517	575	626
11	Eurohem	187	242	304	358	420	437	499	553	615	670
12	Eurohem	199	258	324	382	448	465	531	589	655	714
13	Eurohem	211	274	344	406	476	493	563	625	695	758
14	Eurohem	223	290	364	430	504	521	595	661	735	802
15	Eurohem	235	306	384	454	532	549	627	697	775	846
16	Eurohem	247	322	404	478	560	577	659	733	815	890
17	Eurohem	259	338	424	502	588	605	691	769	855	934
18	Eurohem	271	354	444	526	616	633	723	805	895	978
19	Eurohem	283	370	464	550	644	661	755	841	935	1,022
20	Eurohem	295	386	484	574	672	689	787	877	975	1,066
21	Eurohem	307	402	504	598	700	717	819	913	1,015	1,110
22	Eurohem	319	418	524	622	728	745	851	949	1,055	1,154
23	Eurohem	331	434	544	646	756	773	883	985	1,095	1,198
24	Eurohem	343	450	564	670	784	801	915	1,021	1,135	1,242
25	Eurohem	361	474	594	706	826	843	963	1,075	1,195	1,308
26	Eurohem	373	490	614	730	854	871	995	1,111	1,235	1,352
27	Eurohem	385	506	634	754	882	899	1,027	1,147	1,275	1,396
28	Eurohem	397	522	654	778	910	927	1,059	1,183	1,315	1,440
29	Eurohem	409	538	674	802	938	955	1,091	1,219	1,355	1,484
30	Eurohem	427	562	704	838	980	997	1,139	1,273	1,415	1,550
31	Eurohem	436	574	719	856	1,001	1,018	1,163	1,300	1,445	1,583
32	Eurohem	448	590	739	880	1,029	1,046	1,195	1,336	1,485	1,627
33	Eurohem	463	610	764	910	1,064	1,081	1,235	1,381	1,535	1,682
34	Eurohem	493	650	814	970	1,134	1,151	1,315	1,471	1,635	1,792
35	Eurohem	523	690	864	1,030	1,204	1,221	1,395	1,561	1,735	1,902
36	Eurohem	559	738	924	1,102	1,288	1,305	1,491	1,669	1,855	2,034

Maximum length 101" with 4" hem (exceptions may apply).

Series		Finished Pair or Panel Width									
		36"	48"	60"	72"	84"	96"	108"	120"	132"	144"
07	Hemmed	150	190	240	280	330	349	399	439	489	529
08	Hemmed	165	210	265	310	365	384	439	484	539	584
09	Hemmed	177	226	285	334	393	412	471	520	579	628
10	Hemmed	189	242	305	358	421	440	503	556	619	672
11	Hemmed	201	258	325	382	449	468	535	592	659	716
12	Hemmed	213	274	345	406	477	496	567	628	699	760
13	Hemmed	225	290	365	430	505	524	599	664	739	804
14	Hemmed	237	306	385	454	533	552	631	700	779	848
15	Hemmed	249	322	405	478	561	580	663	736	819	892
16	Hemmed	261	338	425	502	589	608	695	772	859	936
17	Hemmed	273	354	445	526	617	636	727	808	899	980
18	Hemmed	285	370	465	550	645	664	759	844	939	1,024
19	Hemmed	297	386	485	574	673	692	791	880	979	1,068
20	Hemmed	309	402	505	598	701	720	823	916	1,019	1,112
21	Hemmed	321	418	525	622	729	748	855	952	1,059	1,156
22	Hemmed	333	434	545	646	757	776	887	988	1,099	1,200
23	Hemmed	345	450	565	670	785	804	919	1,024	1,139	1,244
24	Hemmed	357	466	585	694	813	832	951	1,060	1,179	1,288
25	Hemmed	375	490	615	730	855	874	999	1,114	1,239	1,354
26	Hemmed	387	506	635	754	883	902	1,031	1,150	1,279	1,398
27	Hemmed	399	522	655	778	911	930	1,063	1,186	1,319	1,442
28	Hemmed	411	538	675	802	939	958	1,095	1,222	1,359	1,486
29	Hemmed	423	554	695	826	967	986	1,127	1,258	1,399	1,530
30	Hemmed	441	578	725	862	1,009	1,028	1,175	1,312	1,459	1,596
31	Hemmed	450	590	740	880	1,030	1,049	1,199	1,339	1,489	1,629
32	Hemmed	462	606	760	904	1,058	1,077	1,231	1,375	1,529	1,673
33	Hemmed	477	626	785	934	1,093	1,112	1,271	1,420	1,579	1,728
34	Hemmed	507	666	835	994	1,163	1,182	1,351	1,510	1,679	1,838
35	Hemmed	537	706	885	1,054	1,233	1,252	1,431	1,600	1,779	1,948
36	Hemmed	573	754	945	1,126	1,317	1,336	1,527	1,708	1,899	2,080

ROD POCKET: Single — 2.5 Fullness — Lined (Lining 01000)

Maximum length 109" with Eurohem (exceptions may apply). Sizes and series numbers beyond what is listed in the charts below are available—please submit these quote requests via fax or email.

Series		Finished Pair or Panel Width									
		36"	48"	60"	72"	84"	96"	108"	120"	132"	144"
07	Eurohem	240	309	389	459	539	558	638	708	788	857
08	Eurohem	255	329	414	489	574	593	678	753	838	912
09	Eurohem	267	345	434	513	602	621	710	789	878	956
10	Eurohem	279	361	454	537	630	649	742	825	918	1,000
11	Eurohem	291	377	474	561	658	677	774	861	958	1,044
12	Eurohem	303	393	494	585	686	705	806	897	998	1,088
13	Eurohem	315	409	514	609	714	733	838	933	1,038	1,132
14	Eurohem	327	425	534	633	742	761	870	969	1,078	1,176
15	Eurohem	339	441	554	657	770	789	902	1,005	1,118	1,220
16	Eurohem	351	457	574	681	798	817	934	1,041	1,158	1,264
17	Eurohem	363	473	594	705	826	845	966	1,077	1,198	1,308
18	Eurohem	375	489	614	729	854	873	998	1,113	1,238	1,352
19	Eurohem	387	505	634	753	882	901	1,030	1,149	1,278	1,396
20	Eurohem	399	521	654	777	910	929	1,062	1,185	1,318	1,440
21	Eurohem	411	537	674	801	938	957	1,094	1,221	1,358	1,484
22	Eurohem	423	553	694	825	966	985	1,126	1,257	1,398	1,528
23	Eurohem	435	569	714	849	994	1,013	1,158	1,293	1,438	1,572
24	Eurohem	447	585	734	873	1,022	1,041	1,190	1,329	1,478	1,616
25	Eurohem	465	609	764	909	1,064	1,083	1,238	1,383	1,538	1,682
26	Eurohem	477	625	784	933	1,092	1,111	1,270	1,419	1,578	1,726
27	Eurohem	489	641	804	957	1,120	1,139	1,302	1,455	1,618	1,770
28	Eurohem	501	657	824	981	1,148	1,167	1,334	1,491	1,658	1,814
29	Eurohem	513	673	844	1,005	1,176	1,195	1,366	1,527	1,698	1,858
30	Eurohem	531	697	874	1,041	1,218	1,237	1,414	1,581	1,758	1,924
31	Eurohem	540	709	889	1,059	1,239	1,258	1,438	1,608	1,788	1,957
32	Eurohem	552	725	909	1,083	1,267	1,286	1,470	1,644	1,828	2,001
33	Eurohem	567	745	934	1,113	1,302	1,321	1,510	1,689	1,878	2,056
34	Eurohem	597	785	984	1,173	1,372	1,391	1,590	1,779	1,978	2,166
35	Eurohem	627	825	1,034	1,233	1,442	1,461	1,670	1,869	2,078	2,276
36	Eurohem	663	873	1,094	1,305	1,526	1,545	1,766	1,977	2,198	2,408

Maximum length 101" with 4" hem (exceptions may apply).

Series		Finished Pair or Panel Width									
		36"	48"	60"	72"	84"	96"	108"	120"	132"	144"
07	Hemmed	252	325	409	481	565	588	672	744	828	901
08	Hemmed	267	345	434	511	600	623	712	789	878	956
09	Hemmed	279	361	454	535	628	651	744	825	918	1,000
10	Hemmed	291	377	474	559	656	679	776	861	958	1,044
11	Hemmed	303	393	494	583	684	707	808	897	998	1,088
12	Hemmed	315	409	514	607	712	735	840	933	1,038	1,132
13	Hemmed	327	425	534	631	740	763	872	969	1,078	1,176
14	Hemmed	339	441	554	655	768	791	904	1,005	1,118	1,220
15	Hemmed	351	457	574	679	796	819	936	1,041	1,158	1,264
16	Hemmed	363	473	594	703	824	847	968	1,077	1,198	1,308
17	Hemmed	375	489	614	727	852	875	1,000	1,113	1,238	1,352
18	Hemmed	387	505	634	751	880	903	1,032	1,149	1,278	1,396
19	Hemmed	399	521	654	775	908	931	1,064	1,185	1,318	1,440
20	Hemmed	411	537	674	799	936	959	1,096	1,221	1,358	1,484
21	Hemmed	423	553	694	823	964	987	1,128	1,257	1,398	1,528
22	Hemmed	435	569	714	847	992	1,015	1,160	1,293	1,438	1,572
23	Hemmed	447	585	734	871	1,020	1,043	1,192	1,329	1,478	1,616
24	Hemmed	459	601	754	895	1,048	1,071	1,224	1,365	1,518	1,660
25	Hemmed	477	625	784	931	1,090	1,113	1,272	1,419	1,578	1,726
26	Hemmed	489	641	804	955	1,118	1,141	1,304	1,455	1,618	1,770
27	Hemmed	501	657	824	979	1,146	1,169	1,336	1,491	1,658	1,814
28	Hemmed	513	673	844	1,003	1,174	1,197	1,368	1,527	1,698	1,858
29	Hemmed	525	689	864	1,027	1,202	1,225	1,400	1,563	1,738	1,902
30	Hemmed	543	713	894	1,063	1,244	1,267	1,448	1,617	1,798	1,968
31	Hemmed	552	725	909	1,081	1,265	1,288	1,472	1,644	1,828	2,001
32	Hemmed	564	741	929	1,105	1,293	1,316	1,504	1,680	1,868	2,045
33	Hemmed	579	761	954	1,135	1,328	1,351	1,544	1,725	1,918	2,100
34	Hemmed	609	801	1,004	1,195	1,398	1,421	1,624	1,815	2,018	2,210
35	Hemmed	639	841	1,054	1,255	1,468	1,491	1,704	1,905	2,118	2,320
36	Hemmed	675	889	1,114	1,327	1,552	1,575	1,800	2,013	2,238	2,452

ROD POCKET: Single — 3 Fullness — Unlined

Maximum length 109" with Eurohem (exceptions may apply). Sizes and series numbers beyond what is listed in the charts below are available—please submit these quote requests via fax or email.

Series		Finished Pair or Panel Width									
		36"	48"	60"	72"	84"	96"	108"	120"	132"	144"
07	Eurohem	165	211	256	301	347	392	437	483	528	573
08	Eurohem	185	236	286	336	387	437	487	538	588	638
09	Eurohem	201	256	310	364	419	473	527	582	636	690
10	Eurohem	217	276	334	392	451	509	567	626	684	742
11	Eurohem	233	296	358	420	483	545	607	670	732	794
12	Eurohem	249	316	382	448	515	581	647	714	780	846
13	Eurohem	265	336	406	476	547	617	687	758	828	898
14	Eurohem	281	356	430	504	579	653	727	802	876	950
15	Eurohem	297	376	454	532	611	689	767	846	924	1,002
16	Eurohem	313	396	478	560	643	725	807	890	972	1,054
17	Eurohem	329	416	502	588	675	761	847	934	1,020	1,106
18	Eurohem	345	436	526	616	707	797	887	978	1,068	1,158
19	Eurohem	361	456	550	644	739	833	927	1,022	1,116	1,210
20	Eurohem	377	476	574	672	771	869	967	1,066	1,164	1,262
21	Eurohem	393	496	598	700	803	905	1,007	1,110	1,212	1,314
22	Eurohem	409	516	622	728	835	941	1,047	1,154	1,260	1,366
23	Eurohem	425	536	646	756	867	977	1,087	1,198	1,308	1,418
24	Eurohem	441	556	670	784	899	1,013	1,127	1,242	1,356	1,470
25	Eurohem	465	586	706	826	947	1,067	1,187	1,308	1,428	1,548
26	Eurohem	481	606	730	854	979	1,103	1,227	1,352	1,476	1,600
27	Eurohem	497	626	754	882	1,011	1,139	1,267	1,396	1,524	1,652
28	Eurohem	513	646	778	910	1,043	1,175	1,307	1,440	1,572	1,704
29	Eurohem	529	666	802	938	1,075	1,211	1,347	1,484	1,620	1,756
30	Eurohem	553	696	838	980	1,123	1,265	1,407	1,550	1,692	1,834
31	Eurohem	565	711	856	1,001	1,147	1,292	1,437	1,583	1,728	1,873
32	Eurohem	581	731	880	1,029	1,179	1,328	1,477	1,627	1,776	1,925
33	Eurohem	601	756	910	1,064	1,219	1,373	1,527	1,682	1,836	1,990
34	Eurohem	641	806	970	1,134	1,299	1,463	1,627	1,792	1,956	2,120
35	Eurohem	681	856	1,030	1,204	1,379	1,553	1,727	1,902	2,076	2,250
36	Eurohem	729	916	1,102	1,288	1,475	1,661	1,847	2,034	2,220	2,406

Maximum length 101" with 4" hem (exceptions may apply).

Series		Finished Pair or Panel Width									
		36"	48"	60"	72"	84"	96"	108"	120"	132"	144"
07	Hemmed	180	230	280	330	380	429	479	529	579	629
08	Hemmed	200	255	310	365	420	474	529	584	639	694
09	Hemmed	216	275	334	393	452	510	569	628	687	746
10	Hemmed	232	295	358	421	484	546	609	672	735	798
11	Hemmed	248	315	382	449	516	582	649	716	783	850
12	Hemmed	264	335	406	477	548	618	689	760	831	902
13	Hemmed	280	355	430	505	580	654	729	804	879	954
14	Hemmed	296	375	454	533	612	690	769	848	927	1,006
15	Hemmed	312	395	478	561	644	726	809	892	975	1,058
16	Hemmed	328	415	502	589	676	762	849	936	1,023	1,110
17	Hemmed	344	435	526	617	708	798	889	980	1,071	1,162
18	Hemmed	360	455	550	645	740	834	929	1,024	1,119	1,214
19	Hemmed	376	475	574	673	772	870	969	1,068	1,167	1,266
20	Hemmed	392	495	598	701	804	906	1,009	1,112	1,215	1,318
21	Hemmed	408	515	622	729	836	942	1,049	1,156	1,263	1,370
22	Hemmed	424	535	646	757	868	978	1,089	1,200	1,311	1,422
23	Hemmed	440	555	670	785	900	1,014	1,129	1,244	1,359	1,474
24	Hemmed	456	575	694	813	932	1,050	1,169	1,288	1,407	1,526
25	Hemmed	480	605	730	855	980	1,104	1,229	1,354	1,479	1,604
26	Hemmed	496	625	754	883	1,012	1,140	1,269	1,398	1,527	1,656
27	Hemmed	512	645	778	911	1,044	1,176	1,309	1,442	1,575	1,708
28	Hemmed	528	665	802	939	1,076	1,212	1,349	1,486	1,623	1,760
29	Hemmed	544	685	826	967	1,108	1,248	1,389	1,530	1,671	1,812
30	Hemmed	568	715	862	1,009	1,156	1,302	1,449	1,596	1,743	1,890
31	Hemmed	580	730	880	1,030	1,180	1,329	1,479	1,629	1,779	1,929
32	Hemmed	596	750	904	1,058	1,212	1,365	1,519	1,673	1,827	1,981
33	Hemmed	616	775	934	1,093	1,252	1,410	1,569	1,728	1,887	2,046
34	Hemmed	656	825	994	1,163	1,332	1,500	1,669	1,838	2,007	2,176
35	Hemmed	696	875	1,054	1,233	1,412	1,590	1,769	1,948	2,127	2,306
36	Hemmed	744	935	1,126	1,317	1,508	1,698	1,889	2,080	2,271	2,462

ROD POCKET: Single — 3 Fullness — Lined (Lining 01000)

Maximum length 109" with Eurohem (exceptions may apply). Sizes and series numbers beyond what is listed in the charts below are available—please submit these quote requests via fax or email.

Series		Finished Pair or Panel Width									
		36"	48"	60"	72"	84"	96"	108"	120"	132"	144"
07	Eurohem	299	379	459	539	618	698	778	857	937	1,017
08	Eurohem	319	404	489	574	658	743	828	912	997	1,082
09	Eurohem	335	424	513	602	690	779	868	956	1,045	1,134
10	Eurohem	351	444	537	630	722	815	908	1,000	1,093	1,186
11	Eurohem	367	464	561	658	754	851	948	1,044	1,141	1,238
12	Eurohem	383	484	585	686	786	887	988	1,088	1,189	1,290
13	Eurohem	399	504	609	714	818	923	1,028	1,132	1,237	1,342
14	Eurohem	415	524	633	742	850	959	1,068	1,176	1,285	1,394
15	Eurohem	431	544	657	770	882	995	1,108	1,220	1,333	1,446
16	Eurohem	447	564	681	798	914	1,031	1,148	1,264	1,381	1,498
17	Eurohem	463	584	705	826	946	1,067	1,188	1,308	1,429	1,550
18	Eurohem	479	604	729	854	978	1,103	1,228	1,352	1,477	1,602
19	Eurohem	495	624	753	882	1,010	1,139	1,268	1,396	1,525	1,654
20	Eurohem	511	644	777	910	1,042	1,175	1,308	1,440	1,573	1,706
21	Eurohem	527	664	801	938	1,074	1,211	1,348	1,484	1,621	1,758
22	Eurohem	543	684	825	966	1,106	1,247	1,388	1,528	1,669	1,810
23	Eurohem	559	704	849	994	1,138	1,283	1,428	1,572	1,717	1,862
24	Eurohem	575	724	873	1,022	1,170	1,319	1,468	1,616	1,765	1,914
25	Eurohem	599	754	909	1,064	1,218	1,373	1,528	1,682	1,837	1,992
26	Eurohem	615	774	933	1,092	1,250	1,409	1,568	1,726	1,885	2,044
27	Eurohem	631	794	957	1,120	1,282	1,445	1,608	1,770	1,933	2,096
28	Eurohem	647	814	981	1,148	1,314	1,481	1,648	1,814	1,981	2,148
29	Eurohem	663	834	1,005	1,176	1,346	1,517	1,688	1,858	2,029	2,200
30	Eurohem	687	864	1,041	1,218	1,394	1,571	1,748	1,924	2,101	2,278
31	Eurohem	699	879	1,059	1,239	1,418	1,598	1,778	1,957	2,137	2,317
32	Eurohem	715	899	1,083	1,267	1,450	1,634	1,818	2,001	2,185	2,369
33	Eurohem	735	924	1,113	1,302	1,490	1,679	1,868	2,056	2,245	2,434
34	Eurohem	775	974	1,173	1,372	1,570	1,769	1,968	2,166	2,365	2,564
35	Eurohem	815	1,024	1,233	1,442	1,650	1,859	2,068	2,276	2,485	2,694
36	Eurohem	863	1,084	1,305	1,526	1,746	1,967	2,188	2,408	2,629	2,850

Maximum length 101" with 4" hem (exceptions may apply).

Series		Finished Pair or Panel Width									
		36"	48"	60"	72"	84"	96"	108"	120"	132"	144"
07	Hemmed	313	397	481	565	649	733	817	901	985	1,069
08	Hemmed	333	422	511	600	689	778	867	956	1,045	1,134
09	Hemmed	349	442	535	628	721	814	907	1,000	1,093	1,186
10	Hemmed	365	462	559	656	753	850	947	1,044	1,141	1,238
11	Hemmed	381	482	583	684	785	886	987	1,088	1,189	1,290
12	Hemmed	397	502	607	712	817	922	1,027	1,132	1,237	1,342
13	Hemmed	413	522	631	740	849	958	1,067	1,176	1,285	1,394
14	Hemmed	429	542	655	768	881	994	1,107	1,220	1,333	1,446
15	Hemmed	445	562	679	796	913	1,030	1,147	1,264	1,381	1,498
16	Hemmed	461	582	703	824	945	1,066	1,187	1,308	1,429	1,550
17	Hemmed	477	602	727	852	977	1,102	1,227	1,352	1,477	1,602
18	Hemmed	493	622	751	880	1,009	1,138	1,267	1,396	1,525	1,654
19	Hemmed	509	642	775	908	1,041	1,174	1,307	1,440	1,573	1,706
20	Hemmed	525	662	799	936	1,073	1,210	1,347	1,484	1,621	1,758
21	Hemmed	541	682	823	964	1,105	1,246	1,387	1,528	1,669	1,810
22	Hemmed	557	702	847	992	1,137	1,282	1,427	1,572	1,717	1,862
23	Hemmed	573	722	871	1,020	1,169	1,318	1,467	1,616	1,765	1,914
24	Hemmed	589	742	895	1,048	1,201	1,354	1,507	1,660	1,813	1,966
25	Hemmed	613	772	931	1,090	1,249	1,408	1,567	1,726	1,885	2,044
26	Hemmed	629	792	955	1,118	1,281	1,444	1,607	1,770	1,933	2,096
27	Hemmed	645	812	979	1,146	1,313	1,480	1,647	1,814	1,981	2,148
28	Hemmed	661	832	1,003	1,174	1,345	1,516	1,687	1,858	2,029	2,200
29	Hemmed	677	852	1,027	1,202	1,377	1,552	1,727	1,902	2,077	2,252
30	Hemmed	701	882	1,063	1,244	1,425	1,606	1,787	1,968	2,149	2,330
31	Hemmed	713	897	1,081	1,265	1,449	1,633	1,817	2,001	2,185	2,369
32	Hemmed	729	917	1,105	1,293	1,481	1,669	1,857	2,045	2,233	2,421
33	Hemmed	749	942	1,135	1,328	1,521	1,714	1,907	2,100	2,293	2,486
34	Hemmed	789	992	1,195	1,398	1,601	1,804	2,007	2,210	2,413	2,616
35	Hemmed	829	1,042	1,255	1,468	1,681	1,894	2,107	2,320	2,533	2,746
36	Hemmed	877	1,102	1,327	1,552	1,777	2,002	2,227	2,452	2,677	2,902

ROD POCKET: Single — 4 Fullness — Unlined

Maximum length 109" with Eurohem (exceptions may apply). Sizes and series numbers beyond what is listed in the charts below are available—please submit these quote requests via fax or email.

Series		Finished Pair or Panel Width									
		36"	48"	60"	72"	84"	96"	108"	120"	132"	144"
07	Eurohem	211	264	318	392	445	499	573	627	680	754
08	Eurohem	236	294	353	437	495	554	638	697	755	839
09	Eurohem	256	318	381	473	535	598	690	753	815	907
10	Eurohem	276	342	409	509	575	642	742	809	875	975
11	Eurohem	296	366	437	545	615	686	794	865	935	1,043
12	Eurohem	316	390	465	581	655	730	846	921	995	1,111
13	Eurohem	336	414	493	617	695	774	898	977	1,055	1,179
14	Eurohem	356	438	521	653	735	818	950	1,033	1,115	1,247
15	Eurohem	376	462	549	689	775	862	1,002	1,089	1,175	1,315
16	Eurohem	396	486	577	725	815	906	1,054	1,145	1,235	1,383
17	Eurohem	416	510	605	761	855	950	1,106	1,201	1,295	1,451
18	Eurohem	436	534	633	797	895	994	1,158	1,257	1,355	1,519
19	Eurohem	456	558	661	833	935	1,038	1,210	1,313	1,415	1,587
20	Eurohem	476	582	689	869	975	1,082	1,262	1,369	1,475	1,655
21	Eurohem	496	606	717	905	1,015	1,126	1,314	1,425	1,535	1,723
22	Eurohem	516	630	745	941	1,055	1,170	1,366	1,481	1,595	1,791
23	Eurohem	536	654	773	977	1,095	1,214	1,418	1,537	1,655	1,859
24	Eurohem	556	678	801	1,013	1,135	1,258	1,470	1,593	1,715	1,927
25	Eurohem	586	714	843	1,067	1,195	1,324	1,548	1,677	1,805	2,029
26	Eurohem	606	738	871	1,103	1,235	1,368	1,600	1,733	1,865	2,097
27	Eurohem	626	762	899	1,139	1,275	1,412	1,652	1,789	1,925	2,165
28	Eurohem	646	786	927	1,175	1,315	1,456	1,704	1,845	1,985	2,233
29	Eurohem	666	810	955	1,211	1,355	1,500	1,756	1,901	2,045	2,301
30	Eurohem	696	846	997	1,265	1,415	1,566	1,834	1,985	2,135	2,403
31	Eurohem	711	864	1,018	1,292	1,445	1,599	1,873	2,027	2,180	2,454
32	Eurohem	731	888	1,046	1,328	1,485	1,643	1,925	2,083	2,240	2,522
33	Eurohem	756	918	1,081	1,373	1,535	1,698	1,990	2,153	2,315	2,607
34	Eurohem	806	978	1,151	1,463	1,635	1,808	2,120	2,293	2,465	2,777
35	Eurohem	856	1,038	1,221	1,553	1,735	1,918	2,250	2,433	2,615	2,947
36	Eurohem	916	1,110	1,305	1,661	1,855	2,050	2,406	2,601	2,795	3,151

Maximum length 101" with 4" hem (exceptions may apply)

Series		Finished Pair or Panel Width									
		36"	48"	60"	72"	84"	96"	108"	120"	132"	144"
07	Hemmed	230	290	349	429	489	548	629	688	747	828
08	Hemmed	255	320	384	474	539	603	694	758	822	913
09	Hemmed	275	344	412	510	579	647	746	814	882	981
10	Hemmed	295	368	440	546	619	691	798	870	942	1,049
11	Hemmed	315	392	468	582	659	735	850	926	1,002	1,117
12	Hemmed	335	416	496	618	699	779	902	982	1,062	1,185
13	Hemmed	355	440	524	654	739	823	954	1,038	1,122	1,253
14	Hemmed	375	464	552	690	779	867	1,006	1,094	1,182	1,321
15	Hemmed	395	488	580	726	819	911	1,058	1,150	1,242	1,389
16	Hemmed	415	512	608	762	859	955	1,110	1,206	1,302	1,457
17	Hemmed	435	536	636	798	899	999	1,162	1,262	1,362	1,525
18	Hemmed	455	560	664	834	939	1,043	1,214	1,318	1,422	1,593
19	Hemmed	475	584	692	870	979	1,087	1,266	1,374	1,482	1,661
20	Hemmed	495	608	720	906	1,019	1,131	1,318	1,430	1,542	1,729
21	Hemmed	515	632	748	942	1,059	1,175	1,370	1,486	1,602	1,797
22	Hemmed	535	656	776	978	1,099	1,219	1,422	1,542	1,662	1,865
23	Hemmed	555	680	804	1,014	1,139	1,263	1,474	1,598	1,722	1,933
24	Hemmed	575	704	832	1,050	1,179	1,307	1,526	1,654	1,782	2,001
25	Hemmed	605	740	874	1,104	1,239	1,373	1,604	1,738	1,872	2,103
26	Hemmed	625	764	902	1,140	1,279	1,417	1,656	1,794	1,932	2,171
27	Hemmed	645	788	930	1,176	1,319	1,461	1,708	1,850	1,992	2,239
28	Hemmed	665	812	958	1,212	1,359	1,505	1,760	1,906	2,052	2,307
29	Hemmed	685	836	986	1,248	1,399	1,549	1,812	1,962	2,112	2,375
30	Hemmed	715	872	1,028	1,302	1,459	1,615	1,890	2,046	2,202	2,477
31	Hemmed	730	890	1,049	1,329	1,489	1,648	1,929	2,088	2,247	2,528
32	Hemmed	750	914	1,077	1,365	1,529	1,692	1,981	2,144	2,307	2,596
33	Hemmed	775	944	1,112	1,410	1,579	1,747	2,046	2,214	2,382	2,681
34	Hemmed	825	1,004	1,182	1,500	1,679	1,857	2,176	2,354	2,532	2,851
35	Hemmed	875	1,064	1,252	1,590	1,779	1,967	2,306	2,494	2,682	3,021
36	Hemmed	935	1,136	1,336	1,698	1,899	2,099	2,462	2,662	2,862	3,225

ROD POCKET: Single — 4 Fullness — Lined (Lining 01000)

Maximum length 109" with Eurohem (exceptions may apply). Sizes and series numbers beyond what is listed in the charts below are available—please submit these quote requests via fax or email.

Series		Finished Pair or Panel Width									
		36"	48"	60"	72"	84"	96"	108"	120"	132"	144"
07	Eurohem	379	469	558	698	788	877	1,017	1,106	1,196	1,336
08	Eurohem	404	499	593	743	838	932	1,082	1,176	1,271	1,421
09	Eurohem	424	523	621	779	878	976	1,134	1,232	1,331	1,489
10	Eurohem	444	547	649	815	918	1,020	1,186	1,288	1,391	1,557
11	Eurohem	464	571	677	851	958	1,064	1,238	1,344	1,451	1,625
12	Eurohem	484	595	705	887	998	1,108	1,290	1,400	1,511	1,693
13	Eurohem	504	619	733	923	1,038	1,152	1,342	1,456	1,571	1,761
14	Eurohem	524	643	761	959	1,078	1,196	1,394	1,512	1,631	1,829
15	Eurohem	544	667	789	995	1,118	1,240	1,446	1,568	1,691	1,897
16	Eurohem	564	691	817	1,031	1,158	1,284	1,498	1,624	1,751	1,965
17	Eurohem	584	715	845	1,067	1,198	1,328	1,550	1,680	1,811	2,033
18	Eurohem	604	739	873	1,103	1,238	1,372	1,602	1,736	1,871	2,101
19	Eurohem	624	763	901	1,139	1,278	1,416	1,654	1,792	1,931	2,169
20	Eurohem	644	787	929	1,175	1,318	1,460	1,706	1,848	1,991	2,237
21	Eurohem	664	811	957	1,211	1,358	1,504	1,758	1,904	2,051	2,305
22	Eurohem	684	835	985	1,247	1,398	1,548	1,810	1,960	2,111	2,373
23	Eurohem	704	859	1,013	1,283	1,438	1,592	1,862	2,016	2,171	2,441
24	Eurohem	724	883	1,041	1,319	1,478	1,636	1,914	2,072	2,231	2,509
25	Eurohem	754	919	1,083	1,373	1,538	1,702	1,992	2,156	2,321	2,611
26	Eurohem	774	943	1,111	1,409	1,578	1,746	2,044	2,212	2,381	2,679
27	Eurohem	794	967	1,139	1,445	1,618	1,790	2,096	2,268	2,441	2,747
28	Eurohem	814	991	1,167	1,481	1,658	1,834	2,148	2,324	2,501	2,815
29	Eurohem	834	1,015	1,195	1,517	1,698	1,878	2,200	2,380	2,561	2,883
30	Eurohem	864	1,051	1,237	1,571	1,758	1,944	2,278	2,464	2,651	2,985
31	Eurohem	879	1,069	1,258	1,598	1,788	1,977	2,317	2,506	2,696	3,036
32	Eurohem	899	1,093	1,286	1,634	1,828	2,021	2,369	2,562	2,756	3,104
33	Eurohem	924	1,123	1,321	1,679	1,878	2,076	2,434	2,632	2,831	3,189
34	Eurohem	974	1,183	1,391	1,769	1,978	2,186	2,564	2,772	2,981	3,359
35	Eurohem	1,024	1,243	1,461	1,859	2,078	2,296	2,694	2,912	3,131	3,529
36	Eurohem	1,084	1,315	1,545	1,967	2,198	2,428	2,850	3,080	3,311	3,733

Maximum length 101" with 4" hem (exceptions may apply)

Series		Finished Pair or Panel Width									
		36"	48"	60"	72"	84"	96"	108"	120"	132"	144"
07	Hemmed	397	493	588	733	828	923	1,069	1,164	1,259	1,404
08	Hemmed	422	523	623	778	878	978	1,134	1,234	1,334	1,489
09	Hemmed	442	547	651	814	918	1,022	1,186	1,290	1,394	1,557
10	Hemmed	462	571	679	850	958	1,066	1,238	1,346	1,454	1,625
11	Hemmed	482	595	707	886	998	1,110	1,290	1,402	1,514	1,693
12	Hemmed	502	619	735	922	1,038	1,154	1,342	1,458	1,574	1,761
13	Hemmed	522	643	763	958	1,078	1,198	1,394	1,514	1,634	1,829
14	Hemmed	542	667	791	994	1,118	1,242	1,446	1,570	1,694	1,897
15	Hemmed	562	691	819	1,030	1,158	1,286	1,498	1,626	1,754	1,965
16	Hemmed	582	715	847	1,066	1,198	1,330	1,550	1,682	1,814	2,033
17	Hemmed	602	739	875	1,102	1,238	1,374	1,602	1,738	1,874	2,101
18	Hemmed	622	763	903	1,138	1,278	1,418	1,654	1,794	1,934	2,169
19	Hemmed	642	787	931	1,174	1,318	1,462	1,706	1,850	1,994	2,237
20	Hemmed	662	811	959	1,210	1,358	1,506	1,758	1,906	2,054	2,305
21	Hemmed	682	835	987	1,246	1,398	1,550	1,810	1,962	2,114	2,373
22	Hemmed	702	859	1,015	1,282	1,438	1,594	1,862	2,018	2,174	2,441
23	Hemmed	722	883	1,043	1,318	1,478	1,638	1,914	2,074	2,234	2,509
24	Hemmed	742	907	1,071	1,354	1,518	1,682	1,966	2,130	2,294	2,577
25	Hemmed	772	943	1,113	1,408	1,578	1,748	2,044	2,214	2,384	2,679
26	Hemmed	792	967	1,141	1,444	1,618	1,792	2,096	2,270	2,444	2,747
27	Hemmed	812	991	1,169	1,480	1,658	1,836	2,148	2,326	2,504	2,815
28	Hemmed	832	1,015	1,197	1,516	1,698	1,880	2,200	2,382	2,564	2,883
29	Hemmed	852	1,039	1,225	1,552	1,738	1,924	2,252	2,438	2,624	2,951
30	Hemmed	882	1,075	1,267	1,606	1,798	1,990	2,330	2,522	2,714	3,053
31	Hemmed	897	1,093	1,288	1,633	1,828	2,023	2,369	2,564	2,759	3,104
32	Hemmed	917	1,117	1,316	1,669	1,868	2,067	2,421	2,620	2,819	3,172
33	Hemmed	942	1,147	1,351	1,714	1,918	2,122	2,486	2,690	2,894	3,257
34	Hemmed	992	1,207	1,421	1,804	2,018	2,232	2,616	2,830	3,044	3,427
35	Hemmed	1,042	1,267	1,491	1,894	2,118	2,342	2,746	2,970	3,194	3,597
36	Hemmed	1,102	1,339	1,575	2,002	2,238	2,474	2,902	3,138	3,374	3,801

ROD POCKET: Double — 2 Fullness — Unlined

Maximum length 101" (exceptions may apply). Sizes and series numbers beyond what is listed in the charts below are available—please submit these quote requests via fax or email.

Series		Finished Pair or Panel Width									
		36"	48"	60"	72"	84"	96"	108"	120"	132"	144"
07	Pocket	131	150	190	230	249	290	330	349	389	429
08	Pocket	146	165	210	255	274	320	365	384	429	474
09	Pocket	158	177	226	275	294	344	393	412	461	510
10	Pocket	170	189	242	295	314	368	421	440	493	546
11	Pocket	182	201	258	315	334	392	449	468	525	582
12	Pocket	194	213	274	335	354	416	477	496	557	618
13	Pocket	206	225	290	355	374	440	505	524	589	654
14	Pocket	218	237	306	375	394	464	533	552	621	690
15	Pocket	230	249	322	395	414	488	561	580	653	726
16	Pocket	242	261	338	415	434	512	589	608	685	762
17	Pocket	254	273	354	435	454	536	617	636	717	798
18	Pocket	266	285	370	455	474	560	645	664	749	834
19	Pocket	278	297	386	475	494	584	673	692	781	870
20	Pocket	290	309	402	495	514	608	701	720	813	906
21	Pocket	302	321	418	515	534	632	729	748	845	942
22	Pocket	314	333	434	535	554	656	757	776	877	978
23	Pocket	326	345	450	555	574	680	785	804	909	1,014
24	Pocket	338	357	466	575	594	704	813	832	941	1,050
25	Pocket	356	375	490	605	624	740	855	874	989	1,104
26	Pocket	368	387	506	625	644	764	883	902	1,021	1,140
27	Pocket	380	399	522	645	664	788	911	930	1,053	1,176
28	Pocket	392	411	538	665	684	812	939	958	1,085	1,212
29	Pocket	404	423	554	685	704	836	967	986	1,117	1,248
30	Pocket	422	441	578	715	734	872	1,009	1,028	1,165	1,302
31	Pocket	431	450	590	730	749	890	1,030	1,049	1,189	1,329
32	Pocket	443	462	606	750	769	914	1,058	1,077	1,221	1,365
33	Pocket	458	477	626	775	794	944	1,093	1,112	1,261	1,410
34	Pocket	488	507	666	825	844	1,004	1,163	1,182	1,341	1,500
35	Pocket	518	537	706	875	894	1,064	1,233	1,252	1,421	1,590
36	Pocket	554	573	754	935	954	1,136	1,317	1,336	1,517	1,698

ROD POCKET: Double — 2 Fullness — Lined (Lining 01000)

Maximum length 101" (exceptions may apply). Sizes and series numbers beyond what is listed in the charts below are available—please submit these quote requests via fax or email.

Series		Finished Pair or Panel Width									
		36"	48"	60"	72"	84"	96"	108"	120"	132"	144"
07	Pocket	230	252	325	397	420	493	565	588	660	733
08	Pocket	245	267	345	422	445	523	600	623	700	778
09	Pocket	257	279	361	442	465	547	628	651	732	814
10	Pocket	269	291	377	462	485	571	656	679	764	850
11	Pocket	281	303	393	482	505	595	684	707	796	886
12	Pocket	293	315	409	502	525	619	712	735	828	922
13	Pocket	305	327	425	522	545	643	740	763	860	958
14	Pocket	317	339	441	542	565	667	768	791	892	994
15	Pocket	329	351	457	562	585	691	796	819	924	1,030
16	Pocket	341	363	473	582	605	715	824	847	956	1,066
17	Pocket	353	375	489	602	625	739	852	875	988	1,102
18	Pocket	365	387	505	622	645	763	880	903	1,020	1,138
19	Pocket	377	399	521	642	665	787	908	931	1,052	1,174
20	Pocket	389	411	537	662	685	811	936	959	1,084	1,210
21	Pocket	401	423	553	682	705	835	964	987	1,116	1,246
22	Pocket	413	435	569	702	725	859	992	1,015	1,148	1,282
23	Pocket	425	447	585	722	745	883	1,020	1,043	1,180	1,318
24	Pocket	437	459	601	742	765	907	1,048	1,071	1,212	1,354
25	Pocket	455	477	625	772	795	943	1,090	1,113	1,260	1,408
26	Pocket	467	489	641	792	815	967	1,118	1,141	1,292	1,444
27	Pocket	479	501	657	812	835	991	1,146	1,169	1,324	1,480
28	Pocket	491	513	673	832	855	1,015	1,174	1,197	1,356	1,516
29	Pocket	503	525	689	852	875	1,039	1,202	1,225	1,388	1,552
30	Pocket	521	543	713	882	905	1,075	1,244	1,267	1,436	1,606
31	Pocket	530	552	725	897	920	1,093	1,265	1,288	1,460	1,633
32	Pocket	542	564	741	917	940	1,117	1,293	1,316	1,492	1,669
33	Pocket	557	579	761	942	965	1,147	1,328	1,351	1,532	1,714
34	Pocket	587	609	801	992	1,015	1,207	1,398	1,421	1,612	1,804
35	Pocket	617	639	841	1,042	1,065	1,267	1,468	1,491	1,692	1,894
36	Pocket	653	675	889	1,102	1,125	1,339	1,552	1,575	1,788	2,002

ROD POCKET: Double — 2.5 Fullness — Unlined

Maximum length 101" (exceptions may apply). Sizes and series numbers beyond what is listed in the charts below are available—please submit these quote requests via fax or email.

Series		Finished Pair or Panel Width									
		36"	48"	60"	72"	84"	96"	108"	120"	132"	144"
07	Pocket	150	190	240	280	330	349	399	439	489	529
08	Pocket	165	210	265	310	365	384	439	484	539	584
09	Pocket	177	226	285	334	393	412	471	520	579	628
10	Pocket	189	242	305	358	421	440	503	556	619	672
11	Pocket	201	258	325	382	449	468	535	592	659	716
12	Pocket	213	274	345	406	477	496	567	628	699	760
13	Pocket	225	290	365	430	505	524	599	664	739	804
14	Pocket	237	306	385	454	533	552	631	700	779	848
15	Pocket	249	322	405	478	561	580	663	736	819	892
16	Pocket	261	338	425	502	589	608	695	772	859	936
17	Pocket	273	354	445	526	617	636	727	808	899	980
18	Pocket	285	370	465	550	645	664	759	844	939	1,024
19	Pocket	297	386	485	574	673	692	791	880	979	1,068
20	Pocket	309	402	505	598	701	720	823	916	1,019	1,112
21	Pocket	321	418	525	622	729	748	855	952	1,059	1,156
22	Pocket	333	434	545	646	757	776	887	988	1,099	1,200
23	Pocket	345	450	565	670	785	804	919	1,024	1,139	1,244
24	Pocket	357	466	585	694	813	832	951	1,060	1,179	1,288
25	Pocket	375	490	615	730	855	874	999	1,114	1,239	1,354
26	Pocket	387	506	635	754	883	902	1,031	1,150	1,279	1,398
27	Pocket	399	522	655	778	911	930	1,063	1,186	1,319	1,442
28	Pocket	411	538	675	802	939	958	1,095	1,222	1,359	1,486
29	Pocket	423	554	695	826	967	986	1,127	1,258	1,399	1,530
30	Pocket	441	578	725	862	1,009	1,028	1,175	1,312	1,459	1,596
31	Pocket	450	590	740	880	1,030	1,049	1,199	1,339	1,489	1,629
32	Pocket	462	606	760	904	1,058	1,077	1,231	1,375	1,529	1,673
33	Pocket	477	626	785	934	1,093	1,112	1,271	1,420	1,579	1,728
34	Pocket	507	666	835	994	1,163	1,182	1,351	1,510	1,679	1,838
35	Pocket	537	706	885	1,054	1,233	1,252	1,431	1,600	1,779	1,948
36	Pocket	573	754	945	1,126	1,317	1,336	1,527	1,708	1,899	2,080

ROD POCKET: Double — 2.5 Fullness — Lined (Lining 01000)

Maximum length 101" (exceptions may apply). Sizes and series numbers beyond what is listed in the charts below are available—please submit these quote requests via fax or email.

Series		Finished Pair or Panel Width									
		36"	48"	60"	72"	84"	96"	108"	120"	132"	144"
07	Pocket	252	325	409	481	565	588	672	744	828	901
08	Pocket	267	345	434	511	600	623	712	789	878	956
09	Pocket	279	361	454	535	628	651	744	825	918	1,000
10	Pocket	291	377	474	559	656	679	776	861	958	1,044
11	Pocket	303	393	494	583	684	707	808	897	998	1,088
12	Pocket	315	409	514	607	712	735	840	933	1,038	1,132
13	Pocket	327	425	534	631	740	763	872	969	1,078	1,176
14	Pocket	339	441	554	655	768	791	904	1,005	1,118	1,220
15	Pocket	351	457	574	679	796	819	936	1,041	1,158	1,264
16	Pocket	363	473	594	703	824	847	968	1,077	1,198	1,308
17	Pocket	375	489	614	727	852	875	1,000	1,113	1,238	1,352
18	Pocket	387	505	634	751	880	903	1,032	1,149	1,278	1,396
19	Pocket	399	521	654	775	908	931	1,064	1,185	1,318	1,440
20	Pocket	411	537	674	799	936	959	1,096	1,221	1,358	1,484
21	Pocket	423	553	694	823	964	987	1,128	1,257	1,398	1,528
22	Pocket	435	569	714	847	992	1,015	1,160	1,293	1,438	1,572
23	Pocket	447	585	734	871	1,020	1,043	1,192	1,329	1,478	1,616
24	Pocket	459	601	754	895	1,048	1,071	1,224	1,365	1,518	1,660
25	Pocket	477	625	784	931	1,090	1,113	1,272	1,419	1,578	1,726
26	Pocket	489	641	804	955	1,118	1,141	1,304	1,455	1,618	1,770
27	Pocket	501	657	824	979	1,146	1,169	1,336	1,491	1,658	1,814
28	Pocket	513	673	844	1,003	1,174	1,197	1,368	1,527	1,698	1,858
29	Pocket	525	689	864	1,027	1,202	1,225	1,400	1,563	1,738	1,902
30	Pocket	543	713	894	1,063	1,244	1,267	1,448	1,617	1,798	1,968
31	Pocket	552	725	909	1,081	1,265	1,288	1,472	1,644	1,828	2,001
32	Pocket	564	741	929	1,105	1,293	1,316	1,504	1,680	1,868	2,045
33	Pocket	579	761	954	1,135	1,328	1,351	1,544	1,725	1,918	2,100
34	Pocket	609	801	1,004	1,195	1,398	1,421	1,624	1,815	2,018	2,210
35	Pocket	639	841	1,054	1,255	1,468	1,491	1,704	1,905	2,118	2,320
36	Pocket	675	889	1,114	1,327	1,552	1,575	1,800	2,013	2,238	2,452

ROD POCKET: Double — 3 Fullness — Unlined

Maximum length 101" (exceptions may apply). Sizes and series numbers beyond what is listed in the charts below are available—please submit these quote requests via fax or email.

Series		Finished Pair or Panel Width									
		36"	48"	60"	72"	84"	96"	108"	120"	132"	144"
07	Pocket	180	230	280	330	380	429	479	529	579	629
08	Pocket	200	255	310	365	420	474	529	584	639	694
09	Pocket	216	275	334	393	452	510	569	628	687	746
10	Pocket	232	295	358	421	484	546	609	672	735	798
11	Pocket	248	315	382	449	516	582	649	716	783	850
12	Pocket	264	335	406	477	548	618	689	760	831	902
13	Pocket	280	355	430	505	580	654	729	804	879	954
14	Pocket	296	375	454	533	612	690	769	848	927	1,006
15	Pocket	312	395	478	561	644	726	809	892	975	1,058
16	Pocket	328	415	502	589	676	762	849	936	1,023	1,110
17	Pocket	344	435	526	617	708	798	889	980	1,071	1,162
18	Pocket	360	455	550	645	740	834	929	1,024	1,119	1,214
19	Pocket	376	475	574	673	772	870	969	1,068	1,167	1,266
20	Pocket	392	495	598	701	804	906	1,009	1,112	1,215	1,318
21	Pocket	408	515	622	729	836	942	1,049	1,156	1,263	1,370
22	Pocket	424	535	646	757	868	978	1,089	1,200	1,311	1,422
23	Pocket	440	555	670	785	900	1,014	1,129	1,244	1,359	1,474
24	Pocket	456	575	694	813	932	1,050	1,169	1,288	1,407	1,526
25	Pocket	480	605	730	855	980	1,104	1,229	1,354	1,479	1,604
26	Pocket	496	625	754	883	1,012	1,140	1,269	1,398	1,527	1,656
27	Pocket	512	645	778	911	1,044	1,176	1,309	1,442	1,575	1,708
28	Pocket	528	665	802	939	1,076	1,212	1,349	1,486	1,623	1,760
29	Pocket	544	685	826	967	1,108	1,248	1,389	1,530	1,671	1,812
30	Pocket	568	715	862	1,009	1,156	1,302	1,449	1,596	1,743	1,890
31	Pocket	580	730	880	1,030	1,180	1,329	1,479	1,629	1,779	1,929
32	Pocket	596	750	904	1,058	1,212	1,365	1,519	1,673	1,827	1,981
33	Pocket	616	775	934	1,093	1,252	1,410	1,569	1,728	1,887	2,046
34	Pocket	656	825	994	1,163	1,332	1,500	1,669	1,838	2,007	2,176
35	Pocket	696	875	1,054	1,233	1,412	1,590	1,769	1,948	2,127	2,306
36	Pocket	744	935	1,126	1,317	1,508	1,698	1,889	2,080	2,271	2,462

ROD POCKET: Double — 3 Fullness — Lined (Lining 01000)

Maximum length 101" (exceptions may apply). Sizes and series numbers beyond what is listed in the charts below are available—please submit these quote requests via fax or email.

Series		Finished Pair or Panel Width									
		36"	48"	60"	72"	84"	96"	108"	120"	132"	144"
07	Pocket	313	397	481	565	649	733	817	901	985	1,069
08	Pocket	333	422	511	600	689	778	867	956	1,045	1,134
09	Pocket	349	442	535	628	721	814	907	1,000	1,093	1,186
10	Pocket	365	462	559	656	753	850	947	1,044	1,141	1,238
11	Pocket	381	482	583	684	785	886	987	1,088	1,189	1,290
12	Pocket	397	502	607	712	817	922	1,027	1,132	1,237	1,342
13	Pocket	413	522	631	740	849	958	1,067	1,176	1,285	1,394
14	Pocket	429	542	655	768	881	994	1,107	1,220	1,333	1,446
15	Pocket	445	562	679	796	913	1,030	1,147	1,264	1,381	1,498
16	Pocket	461	582	703	824	945	1,066	1,187	1,308	1,429	1,550
17	Pocket	477	602	727	852	977	1,102	1,227	1,352	1,477	1,602
18	Pocket	493	622	751	880	1,009	1,138	1,267	1,396	1,525	1,654
19	Pocket	509	642	775	908	1,041	1,174	1,307	1,440	1,573	1,706
20	Pocket	525	662	799	936	1,073	1,210	1,347	1,484	1,621	1,758
21	Pocket	541	682	823	964	1,105	1,246	1,387	1,528	1,669	1,810
22	Pocket	557	702	847	992	1,137	1,282	1,427	1,572	1,717	1,862
23	Pocket	573	722	871	1,020	1,169	1,318	1,467	1,616	1,765	1,914
24	Pocket	589	742	895	1,048	1,201	1,354	1,507	1,660	1,813	1,966
25	Pocket	613	772	931	1,090	1,249	1,408	1,567	1,726	1,885	2,044
26	Pocket	629	792	955	1,118	1,281	1,444	1,607	1,770	1,933	2,096
27	Pocket	645	812	979	1,146	1,313	1,480	1,647	1,814	1,981	2,148
28	Pocket	661	832	1,003	1,174	1,345	1,516	1,687	1,858	2,029	2,200
29	Pocket	677	852	1,027	1,202	1,377	1,552	1,727	1,902	2,077	2,252
30	Pocket	701	882	1,063	1,244	1,425	1,606	1,787	1,968	2,149	2,330
31	Pocket	713	897	1,081	1,265	1,449	1,633	1,817	2,001	2,185	2,369
32	Pocket	729	917	1,105	1,293	1,481	1,669	1,857	2,045	2,233	2,421
33	Pocket	749	942	1,135	1,328	1,521	1,714	1,907	2,100	2,293	2,486
34	Pocket	789	992	1,195	1,398	1,601	1,804	2,007	2,210	2,413	2,616
35	Pocket	829	1,042	1,255	1,468	1,681	1,894	2,107	2,320	2,533	2,746
36	Pocket	877	1,102	1,327	1,552	1,777	2,002	2,227	2,452	2,677	2,902

ROD POCKET: Double — 4 Fullness — Unlined

Maximum length 101" (exceptions may apply). Sizes and series numbers beyond what is listed in the charts below are available—please submit these quote requests via fax or email.

Series		Finished Pair or Panel Width									
		36"	48"	60"	72"	84"	96"	108"	120"	132"	144"
07	Pocket	230	290	349	429	489	548	629	688	747	828
08	Pocket	255	320	384	474	539	603	694	758	822	913
09	Pocket	275	344	412	510	579	647	746	814	882	981
10	Pocket	295	368	440	546	619	691	798	870	942	1,049
11	Pocket	315	392	468	582	659	735	850	926	1,002	1,117
12	Pocket	335	416	496	618	699	779	902	982	1,062	1,185
13	Pocket	355	440	524	654	739	823	954	1,038	1,122	1,253
14	Pocket	375	464	552	690	779	867	1,006	1,094	1,182	1,321
15	Pocket	395	488	580	726	819	911	1,058	1,150	1,242	1,389
16	Pocket	415	512	608	762	859	955	1,110	1,206	1,302	1,457
17	Pocket	435	536	636	798	899	999	1,162	1,262	1,362	1,525
18	Pocket	455	560	664	834	939	1,043	1,214	1,318	1,422	1,593
19	Pocket	475	584	692	870	979	1,087	1,266	1,374	1,482	1,661
20	Pocket	495	608	720	906	1,019	1,131	1,318	1,430	1,542	1,729
21	Pocket	515	632	748	942	1,059	1,175	1,370	1,486	1,602	1,797
22	Pocket	535	656	776	978	1,099	1,219	1,422	1,542	1,662	1,865
23	Pocket	555	680	804	1,014	1,139	1,263	1,474	1,598	1,722	1,933
24	Pocket	575	704	832	1,050	1,179	1,307	1,526	1,654	1,782	2,001
25	Pocket	605	740	874	1,104	1,239	1,373	1,604	1,738	1,872	2,103
26	Pocket	625	764	902	1,140	1,279	1,417	1,656	1,794	1,932	2,171
27	Pocket	645	788	930	1,176	1,319	1,461	1,708	1,850	1,992	2,239
28	Pocket	665	812	958	1,212	1,359	1,505	1,760	1,906	2,052	2,307
29	Pocket	685	836	986	1,248	1,399	1,549	1,812	1,962	2,112	2,375
30	Pocket	715	872	1,028	1,302	1,459	1,615	1,890	2,046	2,202	2,477
31	Pocket	730	890	1,049	1,329	1,489	1,648	1,929	2,088	2,247	2,528
32	Pocket	750	914	1,077	1,365	1,529	1,692	1,981	2,144	2,307	2,596
33	Pocket	775	944	1,112	1,410	1,579	1,747	2,046	2,214	2,382	2,681
34	Pocket	825	1,004	1,182	1,500	1,679	1,857	2,176	2,354	2,532	2,851
35	Pocket	875	1,064	1,252	1,590	1,779	1,967	2,306	2,494	2,682	3,021
36	Pocket	935	1,136	1,336	1,698	1,899	2,099	2,462	2,662	2,862	3,225

ROD POCKET: Double — 4 Fullness — Lined (Lining 01000)

Maximum length 101" (exceptions may apply). Sizes and series numbers beyond what is listed in the charts below are available—please submit these quote requests via fax or email.

Series		Finished Pair or Panel Width									
		36"	48"	60"	72"	84"	96"	108"	120"	132"	144"
07	Pocket	397	493	588	733	828	923	1,069	1,164	1,259	1,404
08	Pocket	422	523	623	778	878	978	1,134	1,234	1,334	1,489
09	Pocket	442	547	651	814	918	1,022	1,186	1,290	1,394	1,557
10	Pocket	462	571	679	850	958	1,066	1,238	1,346	1,454	1,625
11	Pocket	482	595	707	886	998	1,110	1,290	1,402	1,514	1,693
12	Pocket	502	619	735	922	1,038	1,154	1,342	1,458	1,574	1,761
13	Pocket	522	643	763	958	1,078	1,198	1,394	1,514	1,634	1,829
14	Pocket	542	667	791	994	1,118	1,242	1,446	1,570	1,694	1,897
15	Pocket	562	691	819	1,030	1,158	1,286	1,498	1,626	1,754	1,965
16	Pocket	582	715	847	1,066	1,198	1,330	1,550	1,682	1,814	2,033
17	Pocket	602	739	875	1,102	1,238	1,374	1,602	1,738	1,874	2,101
18	Pocket	622	763	903	1,138	1,278	1,418	1,654	1,794	1,934	2,169
19	Pocket	642	787	931	1,174	1,318	1,462	1,706	1,850	1,994	2,237
20	Pocket	662	811	959	1,210	1,358	1,506	1,758	1,906	2,054	2,305
21	Pocket	682	835	987	1,246	1,398	1,550	1,810	1,962	2,114	2,373
22	Pocket	702	859	1,015	1,282	1,438	1,594	1,862	2,018	2,174	2,441
23	Pocket	722	883	1,043	1,318	1,478	1,638	1,914	2,074	2,234	2,509
24	Pocket	742	907	1,071	1,354	1,518	1,682	1,966	2,130	2,294	2,577
25	Pocket	772	943	1,113	1,408	1,578	1,748	2,044	2,214	2,384	2,679
26	Pocket	792	967	1,141	1,444	1,618	1,792	2,096	2,270	2,444	2,747
27	Pocket	812	991	1,169	1,480	1,658	1,836	2,148	2,326	2,504	2,815
28	Pocket	832	1,015	1,197	1,516	1,698	1,880	2,200	2,382	2,564	2,883
29	Pocket	852	1,039	1,225	1,552	1,738	1,924	2,252	2,438	2,624	2,951
30	Pocket	882	1,075	1,267	1,606	1,798	1,990	2,330	2,522	2,714	3,053
31	Pocket	897	1,093	1,288	1,633	1,828	2,023	2,369	2,564	2,759	3,104
32	Pocket	917	1,117	1,316	1,669	1,868	2,067	2,421	2,620	2,819	3,172
33	Pocket	942	1,147	1,351	1,714	1,918	2,122	2,486	2,690	2,894	3,257
34	Pocket	992	1,207	1,421	1,804	2,018	2,232	2,616	2,830	3,044	3,427
35	Pocket	1,042	1,267	1,491	1,894	2,118	2,342	2,746	2,970	3,194	3,597
36	Pocket	1,102	1,339	1,575	2,002	2,238	2,474	2,902	3,138	3,374	3,801

TOP TREATMENTS: Board Mount

Series numbers beyond what is listed in the charts below are available—please submit these quote requests via fax or email.

KICK PLEAT VALANCE

Series	Face Width in Inches								
	36"	54"	72"	90"	108"	126"	144"	162"	180"
07	231	365	461	595	692	805	901	1,035	1,131
08	241	380	481	620	722	835	936	1,075	1,176
09	249	392	497	640	746	859	964	1,107	1,212
10	257	404	513	660	770	883	992	1,139	1,248
11	265	416	529	680	794	907	1,020	1,171	1,284
12	273	428	545	700	818	931	1,048	1,203	1,320
13	281	440	561	720	842	955	1,076	1,235	1,356
14	289	452	577	740	866	979	1,104	1,267	1,392
15	297	464	593	760	890	1,003	1,132	1,299	1,428
16	305	476	609	780	914	1,027	1,160	1,331	1,464
17	313	488	625	800	938	1,051	1,188	1,363	1,500
18	321	500	641	820	962	1,075	1,216	1,395	1,536
19	329	512	657	840	986	1,099	1,244	1,427	1,572
20	337	524	673	860	1,010	1,123	1,272	1,459	1,608
21	345	536	689	880	1,034	1,147	1,300	1,491	1,644
22	353	548	705	900	1,058	1,171	1,328	1,523	1,680
23	361	560	721	920	1,082	1,195	1,356	1,555	1,716
24	369	572	737	940	1,106	1,219	1,384	1,587	1,752
25	381	590	761	970	1,142	1,255	1,426	1,635	1,806
26	389	602	777	990	1,166	1,279	1,454	1,667	1,842
27	397	614	793	1,010	1,190	1,303	1,482	1,699	1,878
28	405	626	809	1,030	1,214	1,327	1,510	1,731	1,914
29	413	638	825	1,050	1,238	1,351	1,538	1,763	1,950
30	425	656	849	1,080	1,274	1,387	1,580	1,811	2,004
31	431	665	861	1,095	1,292	1,405	1,601	1,835	2,031
32	439	677	877	1,115	1,316	1,429	1,629	1,867	2,067
33	449	692	897	1,140	1,346	1,459	1,664	1,907	2,112
34	469	722	937	1,190	1,406	1,519	1,734	1,987	2,202
35	489	752	977	1,240	1,466	1,579	1,804	2,067	2,292
36	513	788	1,025	1,300	1,538	1,651	1,888	2,163	2,400

ARCH-SHAPED VALANCE

Series	Face Width in Inches								
	36"	54"	72"	90"	108"	126"	144"	162"	180"
07	264	384	485	606	706	827	927	1,048	1,148
08	279	399	505	626	731	852	957	1,078	1,183
09	291	411	521	642	751	872	981	1,102	1,211
10	303	423	537	658	771	892	1,005	1,126	1,239
11	315	435	553	674	791	912	1,029	1,150	1,267
12	327	447	569	690	811	932	1,053	1,174	1,295
13	339	459	585	706	831	952	1,077	1,198	1,323
14	351	471	601	722	851	972	1,101	1,222	1,351
15	363	483	617	738	871	992	1,125	1,246	1,379
16	375	495	633	754	891	1,012	1,149	1,270	1,407
17	387	507	649	770	911	1,032	1,173	1,294	1,435
18	399	519	665	786	931	1,052	1,197	1,318	1,463
19	411	531	681	802	951	1,072	1,221	1,342	1,491
20	423	543	697	818	971	1,092	1,245	1,366	1,519
21	435	555	713	834	991	1,112	1,269	1,390	1,547
22	447	567	729	850	1,011	1,132	1,293	1,414	1,575
23	459	579	745	866	1,031	1,152	1,317	1,438	1,603
24	471	591	761	882	1,051	1,172	1,341	1,462	1,631
25	489	609	785	906	1,081	1,202	1,377	1,498	1,673
26	501	621	801	922	1,101	1,222	1,401	1,522	1,701
27	513	633	817	938	1,121	1,242	1,425	1,546	1,729
28	525	645	833	954	1,141	1,262	1,449	1,570	1,757
29	537	657	849	970	1,161	1,282	1,473	1,594	1,785
30	555	675	873	994	1,191	1,312	1,509	1,630	1,827
31	564	684	885	1,006	1,206	1,327	1,527	1,648	1,848
32	576	696	901	1,022	1,226	1,347	1,551	1,672	1,876
33	591	711	921	1,042	1,251	1,372	1,581	1,702	1,911
34	621	741	961	1,082	1,301	1,422	1,641	1,762	1,981
35	651	771	1,001	1,122	1,351	1,472	1,701	1,822	2,051
36	687	807	1,049	1,170	1,411	1,532	1,773	1,894	2,135

TOP TREATMENTS: Board Mount

Series numbers beyond what is listed in the charts below are available—please submit these quote requests via fax or email.

BOX PLEATED VALANCE

Series	Face Width in Inches								
	36"	54"	72"	90"	108"	126"	144"	162"	180"
07	212	333	423	545	635	756	825	947	1,037
08	222	348	443	570	665	791	860	987	1,082
09	230	360	459	590	689	819	888	1,019	1,118
10	238	372	475	610	713	847	916	1,051	1,154
11	246	384	491	630	737	875	944	1,083	1,190
12	254	396	507	650	761	903	972	1,115	1,226
13	262	408	523	670	785	931	1,000	1,147	1,262
14	270	420	539	690	809	959	1,028	1,179	1,298
15	278	432	555	710	833	987	1,056	1,211	1,334
16	286	444	571	730	857	1,015	1,084	1,243	1,370
17	294	456	587	750	881	1,043	1,112	1,275	1,406
18	302	468	603	770	905	1,071	1,140	1,307	1,442
19	310	480	619	790	929	1,099	1,168	1,339	1,478
20	318	492	635	810	953	1,127	1,196	1,371	1,514
21	326	504	651	830	977	1,155	1,224	1,403	1,550
22	334	516	667	850	1,001	1,183	1,252	1,435	1,586
23	342	528	683	870	1,025	1,211	1,280	1,467	1,622
24	350	540	699	890	1,049	1,239	1,308	1,499	1,658
25	362	558	723	920	1,085	1,281	1,350	1,547	1,712
26	370	570	739	940	1,109	1,309	1,378	1,579	1,748
27	378	582	755	960	1,133	1,337	1,406	1,611	1,784
28	386	594	771	980	1,157	1,365	1,434	1,643	1,820
29	394	606	787	1,000	1,181	1,393	1,462	1,675	1,856
30	406	624	811	1,030	1,217	1,435	1,504	1,723	1,910
31	412	633	823	1,045	1,235	1,456	1,525	1,747	1,937
32	420	645	839	1,065	1,259	1,484	1,553	1,779	1,973
33	430	660	859	1,090	1,289	1,519	1,588	1,819	2,018
34	450	690	899	1,140	1,349	1,589	1,658	1,899	2,108
35	470	720	939	1,190	1,409	1,659	1,728	1,979	2,198
36	494	756	987	1,250	1,481	1,743	1,812	2,075	2,306

SCALLOP-SHAPED VALANCE

Series	Face Width in Inches								
	36"	54"	72"	90"	108"	126"	144"	162"	180"
07	212	312	381	503	593	693	783	884	974
08	222	322	391	518	613	713	808	909	1,004
09	230	330	399	530	629	729	828	929	1,028
10	238	338	407	542	645	745	848	949	1,052
11	246	346	415	554	661	761	868	969	1,076
12	254	354	423	566	677	777	888	989	1,100
13	262	362	431	578	693	793	908	1,009	1,124
14	270	370	439	590	709	809	928	1,029	1,148
15	278	378	447	602	725	825	948	1,049	1,172
16	286	386	455	614	741	841	968	1,069	1,196
17	294	394	463	626	757	857	988	1,089	1,220
18	302	402	471	638	773	873	1,008	1,109	1,244
19	310	410	479	650	789	889	1,028	1,129	1,268
20	318	418	487	662	805	905	1,048	1,149	1,292
21	326	426	495	674	821	921	1,068	1,169	1,316
22	334	434	503	686	837	937	1,088	1,189	1,340
23	342	442	511	698	853	953	1,108	1,209	1,364
24	350	450	519	710	869	969	1,128	1,229	1,388
25	362	462	531	728	893	993	1,158	1,259	1,424
26	370	470	539	740	909	1,009	1,178	1,279	1,448
27	378	478	547	752	925	1,025	1,198	1,299	1,472
28	386	486	555	764	941	1,041	1,218	1,319	1,496
29	394	494	563	776	957	1,057	1,238	1,339	1,520
30	406	506	575	794	981	1,081	1,268	1,369	1,556
31	412	512	581	803	993	1,093	1,283	1,384	1,574
32	420	520	589	815	1,009	1,109	1,303	1,404	1,598
33	430	530	599	830	1,029	1,129	1,328	1,429	1,628
34	450	550	619	860	1,069	1,169	1,378	1,479	1,688
35	470	570	639	890	1,109	1,209	1,428	1,529	1,748
36	494	594	663	926	1,157	1,257	1,488	1,589	1,820

TOP TREATMENTS: Rod Mount — Gathered Sleeves

Series numbers beyond what is listed in the charts below are available—please submit these quote requests via fax or email.

GATHERED SLEEVE VALANCE

Series	Face Width in Inches								
	48"	72"	92"	120"	144"	168"	192"	216"	240"
07	38	68	76	105	114	122	152	160	189
08	43	78	86	120	129	137	172	180	214
09	47	86	94	132	141	149	188	196	234
10	51	94	102	144	153	161	204	212	254
11	55	102	110	156	165	173	220	228	274
12	59	110	118	168	177	185	236	244	294
13	63	118	126	180	189	197	252	260	314
14	67	126	134	192	201	209	268	276	334
15	71	134	142	204	213	221	284	292	354
16	75	142	150	216	225	233	300	308	374
17	79	150	158	228	237	245	316	324	394
18	83	158	166	240	249	257	332	340	414
19	87	166	174	252	261	269	348	356	434
20	91	174	182	264	273	281	364	372	454
21	95	182	190	276	285	293	380	388	474
22	99	190	198	288	297	305	396	404	494
23	103	198	206	300	309	317	412	420	514
24	107	206	214	312	321	329	428	436	534
25	113	218	226	330	339	347	452	460	564
26	117	226	234	342	351	359	468	476	584
27	121	234	242	354	363	371	484	492	604
28	125	242	250	366	375	383	500	508	624
29	129	250	258	378	387	395	516	524	644
30	135	262	270	396	405	413	540	548	674
31	138	268	276	405	414	422	552	560	689
32	142	276	284	417	426	434	568	576	709
33	147	286	294	432	441	449	588	596	734
34	157	306	314	462	471	479	628	636	784
35	167	326	334	492	501	509	668	676	834
36	179	350	358	528	537	545	716	724	894

GATHERED SLEEVE VALANCE WITH HEADERS

Series	Face Width in Inches								
	48"	72"	92"	120"	144"	168"	192"	216"	240"
07	45	78	90	101	134	146	158	190	223
08	50	88	100	111	149	161	173	210	248
09	54	96	108	119	161	173	185	226	268
10	58	104	116	127	173	185	197	242	288
11	62	112	124	135	185	197	209	258	308
12	66	120	132	143	197	209	221	274	328
13	70	128	140	151	209	221	233	290	348
14	74	136	148	159	221	233	245	306	368
15	78	144	156	167	233	245	257	322	388
16	82	152	164	175	245	257	269	338	408
17	86	160	172	183	257	269	281	354	428
18	90	168	180	191	269	281	293	370	448
19	94	176	188	199	281	293	305	386	468
20	98	184	196	207	293	305	317	402	488
21	102	192	204	215	305	317	329	418	508
22	106	200	212	223	317	329	341	434	528
23	110	208	220	231	329	341	353	450	548
24	114	216	228	239	341	353	365	466	568
25	120	228	240	251	359	371	383	490	598
26	124	236	248	259	371	383	395	506	618
27	128	244	256	267	383	395	407	522	638
28	132	252	264	275	395	407	419	538	658
29	136	260	272	283	407	419	431	554	678
30	142	272	284	295	425	437	449	578	708
31	145	278	290	301	434	446	458	590	723
32	149	286	298	309	446	458	470	606	743
33	154	296	308	319	461	473	485	626	768
34	164	316	328	339	491	503	515	666	818
35	174	336	348	359	521	533	545	706	868
36	186	360	372	383	557	569	581	754	928

TOP TREATMENTS: Rod Mount — Pleated

Series numbers beyond what is listed in the charts below are available—please submit these quote requests via fax or email.

UNLINED — 2.5 FULLNESS — PINCH / BOHEMIAN / GOBLET PLEAT

Series	Overall Finished Width									
	48"	72"	96"	105"	120"	144"	168"	192"	240"	
07	149	228	297	326	366	445	514	583	731	
08	166	255	332	363	408	497	574	650	816	
09	180	277	360	393	442	539	622	704	884	
10	194	299	388	423	476	581	670	758	952	
11	208	321	416	453	510	623	718	812	1,020	
12	222	343	444	483	544	665	766	866	1,088	
13	236	365	472	513	578	707	814	920	1,156	
14	250	387	500	543	612	749	862	974	1,224	
15	264	409	528	573	646	791	910	1,028	1,292	
16	278	431	556	603	680	833	958	1,082	1,360	
17	292	453	584	633	714	875	1,006	1,136	1,428	
18	306	475	612	663	748	917	1,054	1,190	1,496	
19	320	497	640	693	782	959	1,102	1,244	1,564	
20	334	519	668	723	816	1,001	1,150	1,298	1,632	
21	348	541	696	753	850	1,043	1,198	1,352	1,700	
22	362	563	724	783	884	1,085	1,246	1,406	1,768	
23	376	585	752	813	918	1,127	1,294	1,460	1,836	
24	390	607	780	843	952	1,169	1,342	1,514	1,904	
25	411	640	822	888	1,003	1,232	1,414	1,595	2,006	
26	425	662	850	918	1,037	1,274	1,462	1,649	2,074	
27	439	684	878	948	1,071	1,316	1,510	1,703	2,142	
28	453	706	906	978	1,105	1,358	1,558	1,757	2,210	
29	467	728	934	1,008	1,139	1,400	1,606	1,811	2,278	
30	488	761	976	1,053	1,190	1,463	1,678	1,892	2,380	
31	499	778	997	1,076	1,216	1,495	1,714	1,933	2,431	
32	513	800	1,025	1,106	1,250	1,537	1,762	1,987	2,499	
33	530	827	1,060	1,143	1,292	1,589	1,822	2,054	2,584	
34	565	882	1,130	1,218	1,377	1,694	1,942	2,189	2,754	
35	600	937	1,200	1,293	1,462	1,799	2,062	2,324	2,924	
36	642	1,003	1,284	1,383	1,564	1,925	2,206	2,486	3,128	

LINED — 2.5 FULLNESS — PINCH / BOHEMIAN / GOBLET PLEAT

Series	Overall Finished Width									
	48"	72"	96"	105"	120"	144"	168"	192"	240"	
07	253	391	505	549	618	757	870	984	1,236	
08	270	419	540	586	661	809	930	1,051	1,321	
09	284	441	568	616	695	851	978	1,105	1,389	
10	298	463	596	646	729	893	1,026	1,159	1,457	
11	312	485	624	676	763	935	1,074	1,213	1,525	
12	326	507	652	706	797	977	1,122	1,267	1,593	
13	340	529	680	736	831	1,019	1,170	1,321	1,661	
14	354	551	708	766	865	1,061	1,218	1,375	1,729	
15	368	573	736	796	899	1,103	1,266	1,429	1,797	
16	382	595	764	826	933	1,145	1,314	1,483	1,865	
17	396	617	792	856	967	1,187	1,362	1,537	1,933	
18	410	639	820	886	1,001	1,229	1,410	1,591	2,001	
19	424	661	848	916	1,035	1,271	1,458	1,645	2,069	
20	438	683	876	946	1,069	1,313	1,506	1,699	2,137	
21	452	705	904	976	1,103	1,355	1,554	1,753	2,205	
22	466	727	932	1,006	1,137	1,397	1,602	1,807	2,273	
23	480	749	960	1,036	1,171	1,439	1,650	1,861	2,341	
24	494	771	988	1,066	1,205	1,481	1,698	1,915	2,409	
25	515	804	1,030	1,111	1,256	1,544	1,770	1,996	2,511	
26	529	826	1,058	1,141	1,290	1,586	1,818	2,050	2,579	
27	543	848	1,086	1,171	1,324	1,628	1,866	2,104	2,647	
28	557	870	1,114	1,201	1,358	1,670	1,914	2,158	2,715	
29	571	892	1,142	1,231	1,392	1,712	1,962	2,212	2,783	
30	592	925	1,184	1,276	1,443	1,775	2,034	2,293	2,885	
31	603	941	1,205	1,299	1,468	1,807	2,070	2,334	2,936	
32	617	963	1,233	1,329	1,502	1,849	2,118	2,388	3,004	
33	634	991	1,268	1,366	1,545	1,901	2,178	2,455	3,089	
34	669	1,046	1,338	1,441	1,630	2,006	2,298	2,590	3,259	
35	704	1,101	1,408	1,516	1,715	2,111	2,418	2,725	3,429	
36	746	1,167	1,492	1,606	1,817	2,237	2,562	2,887	3,633	

TOP TREATMENTS: Rod Mount — Grommet

Chart pricing includes grommets and lengths up to 24". Series numbers beyond what is listed in the charts below are available—please submit these quote requests via fax or email.

UNLINED — 2.5 FULLNESS — GROMMET

Series	Overall Finished Width									
	36"	54"	72"	90"	108"	126"	144"	162"	180"	
07	116	172	222	278	327	383	432	488	537	
08	131	192	249	310	367	428	485	546	602	
09	143	208	271	336	399	464	527	592	654	
10	155	224	293	362	431	500	569	638	706	
11	167	240	315	388	463	536	611	684	758	
12	179	256	337	414	495	572	653	730	810	
13	191	272	359	440	527	608	695	776	862	
14	203	288	381	466	559	644	737	822	914	
15	215	304	403	492	591	680	779	868	966	
16	227	320	425	518	623	716	821	914	1,018	
17	239	336	447	544	655	752	863	960	1,070	
18	251	352	469	570	687	788	905	1,006	1,122	
19	263	368	491	596	719	824	947	1,052	1,174	
20	275	384	513	622	751	860	989	1,098	1,226	
21	287	400	535	648	783	896	1,031	1,144	1,278	
22	299	416	557	674	815	932	1,073	1,190	1,330	
23	311	432	579	700	847	968	1,115	1,236	1,382	
24	323	448	601	726	879	1,004	1,157	1,282	1,434	
25	341	472	634	765	927	1,058	1,220	1,351	1,512	
26	353	488	656	791	959	1,094	1,262	1,397	1,564	
27	365	504	678	817	991	1,130	1,304	1,443	1,616	
28	377	520	700	843	1,023	1,166	1,346	1,489	1,668	
29	389	536	722	869	1,055	1,202	1,388	1,535	1,720	
30	407	560	755	908	1,103	1,256	1,451	1,604	1,798	
31	416	572	772	928	1,127	1,283	1,482	1,638	1,837	
32	428	588	794	954	1,159	1,319	1,524	1,684	1,889	
33	443	608	821	986	1,199	1,364	1,577	1,742	1,954	
34	473	648	876	1,051	1,279	1,454	1,682	1,857	2,084	
35	503	688	931	1,116	1,359	1,544	1,787	1,972	2,214	
36	539	736	997	1,194	1,455	1,652	1,913	2,110	2,370	

LINED — 2.5 FULLNESS — GROMMET

Series	Overall Finished Width									
	36"	54"	72"	90"	108"	126"	144"	162"	180"	
07	212	303	399	490	586	677	773	864	959	
08	227	323	427	523	626	722	825	921	1,024	
09	239	339	449	549	658	758	867	967	1,076	
10	251	355	471	575	690	794	909	1,013	1,128	
11	263	371	493	601	722	830	951	1,059	1,180	
12	275	387	515	627	754	866	993	1,105	1,232	
13	287	403	537	653	786	902	1,035	1,151	1,284	
14	299	419	559	679	818	938	1,077	1,197	1,336	
15	311	435	581	705	850	974	1,119	1,243	1,388	
16	323	451	603	731	882	1,010	1,161	1,289	1,440	
17	335	467	625	757	914	1,046	1,203	1,335	1,492	
18	347	483	647	783	946	1,082	1,245	1,381	1,544	
19	359	499	669	809	978	1,118	1,287	1,427	1,596	
20	371	515	691	835	1,010	1,154	1,329	1,473	1,648	
21	383	531	713	861	1,042	1,190	1,371	1,519	1,700	
22	395	547	735	887	1,074	1,226	1,413	1,565	1,752	
23	407	563	757	913	1,106	1,262	1,455	1,611	1,804	
24	419	579	779	939	1,138	1,298	1,497	1,657	1,856	
25	437	603	812	978	1,186	1,352	1,560	1,726	1,934	
26	449	619	834	1,004	1,218	1,388	1,602	1,772	1,986	
27	461	635	856	1,030	1,250	1,424	1,644	1,818	2,038	
28	473	651	878	1,056	1,282	1,460	1,686	1,864	2,090	
29	485	667	900	1,082	1,314	1,496	1,728	1,910	2,142	
30	503	691	933	1,121	1,362	1,550	1,791	1,979	2,220	
31	512	703	949	1,140	1,386	1,577	1,823	2,014	2,259	
32	524	719	971	1,166	1,418	1,613	1,865	2,060	2,311	
33	539	739	999	1,199	1,458	1,658	1,917	2,117	2,376	
34	569	779	1,054	1,264	1,538	1,748	2,022	2,232	2,506	
35	599	819	1,109	1,329	1,618	1,838	2,127	2,347	2,636	
36	635	867	1,175	1,407	1,714	1,946	2,253	2,485	2,792	

TOP TREATMENTS: Rod Mount — Ring Top

Series numbers beyond what is listed in the charts below are available—please submit these quote requests via fax or email.

UNLINED — 2.5 FULLNESS — RING TOP

Series	Overall Finished Width								
	36"	54"	72"	90"	108"	126"	144"	162"	180"
07	105	153	199	247	293	341	387	435	480
08	120	173	226	280	333	386	439	493	545
09	132	189	248	306	365	422	481	539	597
10	144	205	270	332	397	458	523	585	649
11	156	221	292	358	429	494	565	631	701
12	168	237	314	384	461	530	607	677	753
13	180	253	336	410	493	566	649	723	805
14	192	269	358	436	525	602	691	769	857
15	204	285	380	462	557	638	733	815	909
16	216	301	402	488	589	674	775	861	961
17	228	317	424	514	621	710	817	907	1,013
18	240	333	446	540	653	746	859	953	1,065
19	252	349	468	566	685	782	901	999	1,117
20	264	365	490	592	717	818	943	1,045	1,169
21	276	381	512	618	749	854	985	1,091	1,221
22	288	397	534	644	781	890	1,027	1,137	1,273
23	300	413	556	670	813	926	1,069	1,183	1,325
24	312	429	578	696	845	962	1,111	1,229	1,377
25	330	453	611	735	893	1,016	1,174	1,298	1,455
26	342	469	633	761	925	1,052	1,216	1,344	1,507
27	354	485	655	787	957	1,088	1,258	1,390	1,559
28	366	501	677	813	989	1,124	1,300	1,436	1,611
29	378	517	699	839	1,021	1,160	1,342	1,482	1,663
30	396	541	732	878	1,069	1,214	1,405	1,551	1,741
31	405	553	749	897	1,093	1,241	1,437	1,585	1,780
32	417	569	771	923	1,125	1,277	1,479	1,631	1,832
33	432	589	798	956	1,165	1,322	1,531	1,689	1,897
34	462	629	853	1,021	1,245	1,412	1,636	1,804	2,027
35	492	669	908	1,086	1,325	1,502	1,741	1,919	2,157
36	528	717	974	1,164	1,421	1,610	1,867	2,057	2,313

LINED — 2.5 FULLNESS — RING TOP

Series	Overall Finished Width								
	36"	54"	72"	90"	108"	126"	144"	162"	180"
07	197	278	369	450	541	622	713	794	884
08	212	298	397	483	581	667	765	851	949
09	224	314	419	509	613	703	807	897	1,001
10	236	330	441	535	645	739	849	943	1,053
11	248	346	463	561	677	775	891	989	1,105
12	260	362	485	587	709	811	933	1,035	1,157
13	272	378	507	613	741	847	975	1,081	1,209
14	284	394	529	639	773	883	1,017	1,127	1,261
15	296	410	551	665	805	919	1,059	1,173	1,313
16	308	426	573	691	837	955	1,101	1,219	1,365
17	320	442	595	717	869	991	1,143	1,265	1,417
18	332	458	617	743	901	1,027	1,185	1,311	1,469
19	344	474	639	769	933	1,063	1,227	1,357	1,521
20	356	490	661	795	965	1,099	1,269	1,403	1,573
21	368	506	683	821	997	1,135	1,311	1,449	1,625
22	380	522	705	847	1,029	1,171	1,353	1,495	1,677
23	392	538	727	873	1,061	1,207	1,395	1,541	1,729
24	404	554	749	899	1,093	1,243	1,437	1,587	1,781
25	422	578	782	938	1,141	1,297	1,500	1,656	1,859
26	434	594	804	964	1,173	1,333	1,542	1,702	1,911
27	446	610	826	990	1,205	1,369	1,584	1,748	1,963
28	458	626	848	1,016	1,237	1,405	1,626	1,794	2,015
29	470	642	870	1,042	1,269	1,441	1,668	1,840	2,067
30	488	666	903	1,081	1,317	1,495	1,731	1,909	2,145
31	497	678	919	1,100	1,341	1,522	1,763	1,944	2,184
32	509	694	941	1,126	1,373	1,558	1,805	1,990	2,236
33	524	714	969	1,159	1,413	1,603	1,857	2,047	2,301
34	554	754	1,024	1,224	1,493	1,693	1,962	2,162	2,431
35	584	794	1,079	1,289	1,573	1,783	2,067	2,277	2,561
36	620	842	1,145	1,367	1,669	1,891	2,193	2,415	2,717

TOP TREATMENTS: Rod Mount — Rod Pocket

Series numbers beyond what is listed in the charts below are available—please submit these quote requests via fax or email.

UNLINED — 2.5 FULLNESS — ROD POCKET

Series	Overall Finished Width									
	36"	54"	72"	90"	108"	126"	144"	162"	180"	
07	106	148	200	243	290	332	385	427	474	
08	121	168	228	275	330	377	437	484	539	
09	133	184	250	301	362	413	479	530	591	
10	145	200	272	327	394	449	521	576	643	
11	157	216	294	353	426	485	563	622	695	
12	169	232	316	379	458	521	605	668	747	
13	181	248	338	405	490	557	647	714	799	
14	193	264	360	431	522	593	689	760	851	
15	205	280	382	457	554	629	731	806	903	
16	217	296	404	483	586	665	773	852	955	
17	229	312	426	509	618	701	815	898	1,007	
18	241	328	448	535	650	737	857	944	1,059	
19	253	344	470	561	682	773	899	990	1,111	
20	265	360	492	587	714	809	941	1,036	1,163	
21	277	376	514	613	746	845	983	1,082	1,215	
22	289	392	536	639	778	881	1,025	1,128	1,267	
23	301	408	558	665	810	917	1,067	1,174	1,319	
24	313	424	580	691	842	953	1,109	1,220	1,371	
25	331	448	613	730	890	1,007	1,172	1,289	1,449	
26	343	464	635	756	922	1,043	1,214	1,335	1,501	
27	355	480	657	782	954	1,079	1,256	1,381	1,553	
28	367	496	679	808	986	1,115	1,298	1,427	1,605	
29	379	512	701	834	1,018	1,151	1,340	1,473	1,657	
30	397	536	734	873	1,066	1,205	1,403	1,542	1,735	
31	406	548	750	893	1,090	1,232	1,435	1,577	1,774	
32	418	564	772	919	1,122	1,268	1,477	1,623	1,826	
33	433	584	800	951	1,162	1,313	1,529	1,680	1,891	
34	463	624	855	1,016	1,242	1,403	1,634	1,795	2,021	
35	493	664	910	1,081	1,322	1,493	1,739	1,910	2,151	
36	529	712	976	1,159	1,418	1,601	1,865	2,048	2,307	

LINED — 2.5 FULLNESS — ROD POCKET

Series	Overall Finished Width									
	36"	54"	72"	90"	108"	126"	144"	162"	180"	
07	201	277	377	453	547	622	723	798	892	
08	216	297	405	485	587	667	775	856	957	
09	228	313	427	511	619	703	817	902	1,009	
10	240	329	449	537	651	739	859	948	1,061	
11	252	345	471	563	683	775	901	994	1,113	
12	264	361	493	589	715	811	943	1,040	1,165	
13	276	377	515	615	747	847	985	1,086	1,217	
14	288	393	537	641	779	883	1,027	1,132	1,269	
15	300	409	559	667	811	919	1,069	1,178	1,321	
16	312	425	581	693	843	955	1,111	1,224	1,373	
17	324	441	603	719	875	991	1,153	1,270	1,425	
18	336	457	625	745	907	1,027	1,195	1,316	1,477	
19	348	473	647	771	939	1,063	1,237	1,362	1,529	
20	360	489	669	797	971	1,099	1,279	1,408	1,581	
21	372	505	691	823	1,003	1,135	1,321	1,454	1,633	
22	384	521	713	849	1,035	1,171	1,363	1,500	1,685	
23	396	537	735	875	1,067	1,207	1,405	1,546	1,737	
24	408	553	757	901	1,099	1,243	1,447	1,592	1,789	
25	426	577	790	940	1,147	1,297	1,510	1,661	1,867	
26	438	593	812	966	1,179	1,333	1,552	1,707	1,919	
27	450	609	834	992	1,211	1,369	1,594	1,753	1,971	
28	462	625	856	1,018	1,243	1,405	1,636	1,799	2,023	
29	474	641	878	1,044	1,275	1,441	1,678	1,845	2,075	
30	492	665	911	1,083	1,323	1,495	1,741	1,914	2,153	
31	501	677	927	1,103	1,347	1,522	1,773	1,948	2,192	
32	513	693	949	1,129	1,379	1,558	1,815	1,994	2,244	
33	528	713	977	1,161	1,419	1,603	1,867	2,052	2,309	
34	558	753	1,032	1,226	1,499	1,693	1,972	2,167	2,439	
35	588	793	1,087	1,291	1,579	1,783	2,077	2,282	2,569	
36	624	841	1,153	1,369	1,675	1,891	2,203	2,420	2,725	

TOP TREATMENTS: Board Mount Swags

Series numbers beyond what is listed in the charts below are available—please submit these quote requests via fax or email.

BELL SWAG VALANCE

Series	Swags									
	1	2	3	3	4	5	5	6	7	7
	Face Width in Inches									
	36"	54"	72"	90"	108"	126"	144"	162"	180"	
07	264	426	527	669	769	932	1,011	1,174	1,274	
08	279	451	557	704	809	982	1,061	1,234	1,339	
09	291	471	581	732	841	1,022	1,101	1,282	1,391	
10	303	491	605	760	873	1,062	1,141	1,330	1,443	
11	315	511	629	788	905	1,102	1,181	1,378	1,495	
12	327	531	653	816	937	1,142	1,221	1,426	1,547	
13	339	551	677	844	969	1,182	1,261	1,474	1,599	
14	351	571	701	872	1,001	1,222	1,301	1,522	1,651	
15	363	591	725	900	1,033	1,262	1,341	1,570	1,703	
16	375	611	749	928	1,065	1,302	1,381	1,618	1,755	
17	387	631	773	956	1,097	1,342	1,421	1,666	1,807	
18	399	651	797	984	1,129	1,382	1,461	1,714	1,859	
19	411	671	821	1,012	1,161	1,422	1,501	1,762	1,911	
20	423	691	845	1,040	1,193	1,462	1,541	1,810	1,963	
21	435	711	869	1,068	1,225	1,502	1,581	1,858	2,015	
22	447	731	893	1,096	1,257	1,542	1,621	1,906	2,067	
23	459	751	917	1,124	1,289	1,582	1,661	1,954	2,119	
24	471	771	941	1,152	1,321	1,622	1,701	2,002	2,171	
25	489	801	977	1,194	1,369	1,682	1,761	2,074	2,249	
26	501	821	1,001	1,222	1,401	1,722	1,801	2,122	2,301	
27	513	841	1,025	1,250	1,433	1,762	1,841	2,170	2,353	
28	525	861	1,049	1,278	1,465	1,802	1,881	2,218	2,405	
29	537	881	1,073	1,306	1,497	1,842	1,921	2,266	2,457	
30	555	911	1,109	1,348	1,545	1,902	1,981	2,338	2,535	
31	564	926	1,127	1,369	1,569	1,932	2,011	2,374	2,574	
32	576	946	1,151	1,397	1,601	1,972	2,051	2,422	2,626	
33	591	971	1,181	1,432	1,641	2,022	2,101	2,482	2,691	
34	621	1,021	1,241	1,502	1,721	2,122	2,201	2,602	2,821	
35	651	1,071	1,301	1,572	1,801	2,222	2,301	2,722	2,951	
36	687	1,131	1,373	1,656	1,897	2,342	2,421	2,866	3,107	

TRADITIONAL SWAG — CASCADES UP TO 36"

Series	Swags						
	1	2	3	4	5	6	7
	Face Width in Inches						
	48"	72"	96"	120"	144"	168"	192"
07	430	664	897	1,130	1,314	1,547	1,781
08	455	699	942	1,185	1,374	1,617	1,861
09	475	727	978	1,229	1,422	1,673	1,925
10	495	755	1,014	1,273	1,470	1,729	1,989
11	515	783	1,050	1,317	1,518	1,785	2,053
12	535	811	1,086	1,361	1,566	1,841	2,117
13	555	839	1,122	1,405	1,614	1,897	2,181
14	575	867	1,158	1,449	1,662	1,953	2,245
15	595	895	1,194	1,493	1,710	2,009	2,309
16	615	923	1,230	1,537	1,758	2,065	2,373
17	635	951	1,266	1,581	1,806	2,121	2,437
18	655	979	1,302	1,625	1,854	2,177	2,501
19	675	1,007	1,338	1,669	1,902	2,233	2,565
20	695	1,035	1,374	1,713	1,950	2,289	2,629
21	715	1,063	1,410	1,757	1,998	2,345	2,693
22	735	1,091	1,446	1,801	2,046	2,401	2,757
23	755	1,119	1,482	1,845	2,094	2,457	2,821
24	775	1,147	1,518	1,889	2,142	2,513	2,885
25	805	1,189	1,572	1,955	2,214	2,597	2,981
26	825	1,217	1,608	1,999	2,262	2,653	3,045
27	845	1,245	1,644	2,043	2,310	2,709	3,109
28	865	1,273	1,680	2,087	2,358	2,765	3,173
29	885	1,301	1,716	2,131	2,406	2,821	3,237
30	915	1,343	1,770	2,197	2,478	2,905	3,333
31	930	1,364	1,797	2,230	2,514	2,947	3,381
32	950	1,392	1,833	2,274	2,562	3,003	3,445
33	975	1,427	1,878	2,329	2,622	3,073	3,525
34	1,025	1,497	1,968	2,439	2,742	3,213	3,685
35	1,075	1,567	2,058	2,549	2,862	3,353	3,845
36	1,135	1,651	2,166	2,681	3,006	3,521	4,037

TRADITIONAL SWAG — CASCADES UP TO 110"

Series	Swags						
	1	2	3	4	5	6	7
	Face Width in Inches						
	48"	72"	96"	120"	144"	168"	192"
07	493	727	960	1,193	1,377	1,610	1,844
08	533	777	1,020	1,263	1,452	1,695	1,939
09	565	817	1,068	1,319	1,512	1,763	2,015
10	597	857	1,116	1,375	1,572	1,831	2,091
11	629	897	1,164	1,431	1,632	1,899	2,167
12	661	937	1,212	1,487	1,692	1,967	2,243
13	693	977	1,260	1,543	1,752	2,035	2,319
14	725	1,017	1,308	1,599	1,812	2,103	2,395
15	757	1,057	1,356	1,655	1,872	2,171	2,471
16	789	1,097	1,404	1,711	1,932	2,239	2,547
17	821	1,137	1,452	1,767	1,992	2,307	2,623
18	853	1,177	1,500	1,823	2,052	2,375	2,699
19	885	1,217	1,548	1,879	2,112	2,443	2,775
20	917	1,257	1,596	1,935	2,172	2,511	2,851
21	949	1,297	1,644	1,991	2,232	2,579	2,927
22	981	1,337	1,692	2,047	2,292	2,647	3,003
23	1,013	1,377	1,740	2,103	2,352	2,715	3,079
24	1,045	1,417	1,788	2,159	2,412	2,783	3,155
25	1,093	1,477	1,860	2,243	2,502	2,885	3,269
26	1,125	1,517	1,908	2,299	2,562	2,953	3,345
27	1,157	1,557	1,956	2,355	2,622	3,021	3,421
28	1,189	1,597	2,004	2,411	2,682	3,089	3,497
29	1,221	1,637	2,052	2,467	2,742	3,157	3,573
30	1,269	1,697	2,124	2,551	2,832	3,259	3,687
31	1,293	1,727	2,160	2,593	2,877	3,310	3,744
32	1,325	1,767	2,208	2,649	2,937	3,378	3,820
33	1,365	1,817	2,268	2,719	3,012	3,463	3,915
34	1,445	1,917	2,388	2,859	3,162	3,633	4,105
35	1,525	2,017	2,508	2,999	3,312	3,803	4,295
36	1,621	2,137	2,652	3,167	3,492	4,007	4,523

TOP TREATMENTS: Rod Mount Swags

Series numbers beyond what is listed in the charts below are available—please submit these quote requests via fax or email.

ROUNDED SWAG				ROUNDED SWAG W/ CASCADE				POINTED BELL SWAG			
Series	Face Width in Inches			Series	Face Width in Inches			Series	Face Width in Inches		
	18"	25"	37"		18"	25"	37"		18"	25"	37"
07	135	181	227	07	231	294	357	07	178	225	272
08	145	191	237	08	256	319	382	08	198	245	292
09	153	199	245	09	276	339	402	09	214	261	308
10	161	207	253	10	296	359	422	10	230	277	324
11	169	215	261	11	316	379	442	11	246	293	340
12	177	223	269	12	336	399	462	12	262	309	356
13	185	231	277	13	356	419	482	13	278	325	372
14	193	239	285	14	376	439	502	14	294	341	388
15	201	247	293	15	396	459	522	15	310	357	404
16	209	255	301	16	416	479	542	16	326	373	420
17	217	263	309	17	436	499	562	17	342	389	436
18	225	271	317	18	456	519	582	18	358	405	452
19	233	279	325	19	476	539	602	19	374	421	468
20	241	287	333	20	496	559	622	20	390	437	484
21	249	295	341	21	516	579	642	21	406	453	500
22	257	303	349	22	536	599	662	22	422	469	516
23	265	311	357	23	556	619	682	23	438	485	532
24	273	319	365	24	576	639	702	24	454	501	548
25	285	331	377	25	606	669	732	25	478	525	572
26	293	339	385	26	626	689	752	26	494	541	588
27	301	347	393	27	646	709	772	27	510	557	604
28	309	355	401	28	666	729	792	28	526	573	620
29	317	363	409	29	686	749	812	29	542	589	636
30	329	375	421	30	716	779	842	30	566	613	660
31	335	381	427	31	731	794	857	31	578	625	672
32	343	389	435	32	751	814	877	32	594	641	688
33	353	399	445	33	776	839	902	33	614	661	708
34	373	419	465	34	826	889	952	34	654	701	748
35	393	439	485	35	876	939	1,002	35	694	741	788
36	417	463	509	36	936	999	1,062	36	742	789	836

POLE SWAG

Series	Swags					
	1	2	3	4	5	6
	Face Width in Inches					
	50"	92"	124"	156"	188"	220"
07	321	509	698	851	1,039	1,228
08	356	564	773	946	1,154	1,363
09	384	608	833	1,022	1,246	1,471
10	412	652	893	1,098	1,338	1,579
11	440	696	953	1,174	1,430	1,687
12	468	740	1,013	1,250	1,522	1,795
13	496	784	1,073	1,326	1,614	1,903
14	524	828	1,133	1,402	1,706	2,011
15	552	872	1,193	1,478	1,798	2,119
16	580	916	1,253	1,554	1,890	2,227
17	608	960	1,313	1,630	1,982	2,335
18	636	1,004	1,373	1,706	2,074	2,443
19	664	1,048	1,433	1,782	2,166	2,551
20	692	1,092	1,493	1,858	2,258	2,659
21	720	1,136	1,553	1,934	2,350	2,767
22	748	1,180	1,613	2,010	2,442	2,875
23	776	1,224	1,673	2,086	2,534	2,983
24	804	1,268	1,733	2,162	2,626	3,091
25	846	1,334	1,823	2,276	2,764	3,253
26	874	1,378	1,883	2,352	2,856	3,361
27	902	1,422	1,943	2,428	2,948	3,469
28	930	1,466	2,003	2,504	3,040	3,577
29	958	1,510	2,063	2,580	3,132	3,685
30	1,000	1,576	2,153	2,694	3,270	3,847
31	1,021	1,609	2,198	2,751	3,339	3,928
32	1,049	1,653	2,258	2,827	3,431	4,036
33	1,084	1,708	2,333	2,922	3,546	4,171
34	1,154	1,818	2,483	3,112	3,776	4,441
35	1,224	1,928	2,633	3,302	4,006	4,711
36	1,308	2,060	2,813	3,530	4,282	5,035

TOP TREATMENTS: Pouf Swags

Series numbers beyond what is listed in the charts below are available—please submit these quote requests via fax or email.

MULTIPLE SWAGS — STRAIGHT OR RELAXED TOP W/ TAILS & POUFS

Series	Swags					
	2	3	4	5	6	7
	Face Width in Inches					
	48"-76"	77"-120"	121"-168"	169"-220"	221"-276"	277"-336"
07	345	492	647	830	1,006	1,210
08	380	542	707	900	1,091	1,310
09	408	582	755	956	1,159	1,390
10	436	622	803	1,012	1,227	1,470
11	464	662	851	1,068	1,295	1,550
12	492	702	899	1,124	1,363	1,630
13	520	742	947	1,180	1,431	1,710
14	548	782	995	1,236	1,499	1,790
15	576	822	1,043	1,292	1,567	1,870
16	604	862	1,091	1,348	1,635	1,950
17	632	902	1,139	1,404	1,703	2,030
18	660	942	1,187	1,460	1,771	2,110
19	688	982	1,235	1,516	1,839	2,190
20	716	1,022	1,283	1,572	1,907	2,270
21	744	1,062	1,331	1,628	1,975	2,350
22	772	1,102	1,379	1,684	2,043	2,430
23	800	1,142	1,427	1,740	2,111	2,510
24	828	1,182	1,475	1,796	2,179	2,590
25	870	1,242	1,547	1,880	2,281	2,710
26	898	1,282	1,595	1,936	2,349	2,790
27	926	1,322	1,643	1,992	2,417	2,870
28	954	1,362	1,691	2,048	2,485	2,950
29	982	1,402	1,739	2,104	2,553	3,030
30	1,024	1,462	1,811	2,188	2,655	3,150
31	1,045	1,492	1,847	2,230	2,706	3,210
32	1,073	1,532	1,895	2,286	2,774	3,290
33	1,108	1,582	1,955	2,356	2,859	3,390
34	1,178	1,682	2,075	2,496	3,029	3,590
35	1,248	1,782	2,195	2,636	3,199	3,790
36	1,332	1,902	2,339	2,804	3,403	4,030

SINGLE SWAG — STRAIGHT OR RELAXED TOP W/ TAILS & POUFS

Series	Face Width in Inches						
	36"	48"	60"	72"	84"	96"	120"
07	186	213	240	288	315	342	417
08	211	238	265	318	345	372	452
09	231	258	285	342	369	396	480
10	251	278	305	366	393	420	508
11	271	298	325	390	417	444	536
12	291	318	345	414	441	468	564
13	311	338	365	438	465	492	592
14	331	358	385	462	489	516	620
15	351	378	405	486	513	540	648
16	371	398	425	510	537	564	676
17	391	418	445	534	561	588	704
18	411	438	465	558	585	612	732
19	431	458	485	582	609	636	760
20	451	478	505	606	633	660	788
21	471	498	525	630	657	684	816
22	491	518	545	654	681	708	844
23	511	538	565	678	705	732	872
24	531	558	585	702	729	756	900
25	561	588	615	738	765	792	942
26	581	608	635	762	789	816	970
27	601	628	655	786	813	840	998
28	621	648	675	810	837	864	1,026
29	641	668	695	834	861	888	1,054
30	671	698	725	870	897	924	1,096
31	686	713	740	888	915	942	1,117
32	706	733	760	912	939	966	1,145
33	731	758	785	942	969	996	1,180
34	781	808	835	1,002	1,029	1,056	1,250
35	831	858	885	1,062	1,089	1,116	1,320
36	891	918	945	1,134	1,161	1,188	1,404

STRAIGHT TIEBACKS: Single

Width is flat width for a single tieback. Pricing is for a single tieback.

Series	Straight Plain			Straight Trim			Straight Corded		
	Flat Width			Flat Width			Flat Width		
	18	25	37	18	25	37	18	25	37
07	25	33	39	51	72	79	45	57	67
08	28	36	41	54	74	82	50	62	72
09	30	38	43	56	76	84	54	66	76
10	32	40	45	58	78	86	58	70	80
11	34	42	47	60	80	88	62	74	84
12	36	44	49	62	82	90	66	78	88
13	38	46	51	64	84	92	70	82	92
14	40	48	53	66	86	94	74	86	96
15	42	50	55	68	88	96	78	90	100
16	44	52	57	70	90	98	82	94	104
17	46	54	59	72	92	100	86	98	108
18	48	56	61	74	94	102	90	102	112
19	50	58	63	76	96	104	94	106	116
20	52	60	65	78	98	106	98	110	120
21	54	62	67	80	100	108	102	114	124
22	56	64	69	82	102	110	106	118	128
23	58	66	71	84	104	112	110	122	132
24	60	68	73	86	106	114	114	126	136
25	63	71	76	89	109	117	120	132	142
26	65	73	78	91	111	119	124	136	146
27	67	75	80	93	113	121	128	140	150
28	69	77	82	95	115	123	132	144	154
29	71	79	84	97	117	125	136	148	158
30	74	82	87	100	120	128	142	154	164
31	75	83	89	101	122	129	145	157	167
32	77	85	91	103	124	131	149	161	171
33	80	88	93	106	126	134	154	166	176
34	85	93	98	111	131	139	164	176	186
35	90	98	103	116	136	144	174	186	196
36	96	104	109	122	142	150	186	198	208

STRAIGHT TIEBACKS: Pair

Width is flat width for each tieback. Pricing is for a pair of tiebacks.

Series	Straight Plain			Straight Trim			Straight Corded		
	Flat Width			Flat Width			Flat Width		
	18	25	37	18	25	37	18	25	37
07	40	55	67	81	122	148	68	93	112
08	42	58	69	83	124	150	73	98	117
09	44	60	71	85	126	152	77	102	121
10	46	62	73	87	128	154	81	106	125
11	48	64	75	89	130	156	85	110	129
12	50	66	77	91	132	158	89	114	133
13	52	68	79	93	134	160	93	118	137
14	54	70	81	95	136	162	97	122	141
15	56	72	83	97	138	164	101	126	145
16	58	74	85	99	140	166	105	130	149
17	60	76	87	101	142	168	109	134	153
18	62	78	89	103	144	170	113	138	157
19	64	80	91	105	146	172	117	142	161
20	66	82	93	107	148	174	121	146	165
21	68	84	95	109	150	176	125	150	169
22	70	86	97	111	152	178	129	154	173
23	72	88	99	113	154	180	133	158	177
24	74	90	101	115	156	182	137	162	181
25	77	93	104	118	159	185	143	168	187
26	79	95	106	120	161	187	147	172	191
27	81	97	108	122	163	189	151	176	195
28	83	99	110	124	165	191	155	180	199
29	85	101	112	126	167	193	159	184	203
30	88	104	115	129	170	196	165	190	209
31	90	105	117	131	172	198	168	193	212
32	92	107	119	133	174	200	172	197	216
33	94	110	121	135	176	202	177	202	221
34	99	115	126	140	181	207	187	212	231
35	104	120	131	145	186	212	197	222	241
36	110	126	137	151	192	218	209	234	253

TAPERED TIEBACKS: Single

Width is flat width for a single tieback. Pricing is for a single tieback.

Series	Tapered Plain			Tapered Trim			Tapered Corded		
	Flat Width			Flat Width			Flat Width		
	18	25	37	18	25	37	18	25	37
07	27	35	42	53	74	83	50	65	76
08	29	38	44	56	77	86	55	70	81
09	31	40	46	58	79	88	59	74	85
10	33	42	48	60	81	90	63	78	89
11	35	44	50	62	83	92	67	82	93
12	37	46	52	64	85	94	71	86	97
13	39	48	54	66	87	96	75	90	101
14	41	50	56	68	89	98	79	94	105
15	43	52	58	70	91	100	83	98	109
16	45	54	60	72	93	102	87	102	113
17	47	56	62	74	95	104	91	106	117
18	49	58	64	76	97	106	95	110	121
19	51	60	66	78	99	108	99	114	125
20	53	62	68	80	101	110	103	118	129
21	55	64	70	82	103	112	107	122	133
22	57	66	72	84	105	114	111	126	137
23	59	68	74	86	107	116	115	130	141
24	61	70	76	88	109	118	119	134	145
25	64	73	79	91	112	121	125	140	151
26	66	75	81	93	114	123	129	144	155
27	68	77	83	95	116	125	133	148	159
28	70	79	85	97	118	127	137	152	163
29	72	81	87	99	120	129	141	156	167
30	75	84	90	102	123	132	147	162	173
31	77	85	92	103	124	133	150	165	176
32	79	87	94	105	126	135	154	169	180
33	81	90	96	108	129	138	159	174	185
34	86	95	101	113	134	143	169	184	195
35	91	100	106	118	139	148	179	194	205
36	97	106	112	124	145	154	191	206	217

TAPERED TIEBACKS: Pair

Width is flat width for each tieback. Pricing is for a pair of tiebacks.

Series	Tapered Plain			Tapered Trim			Tapered Corded		
	Flat Width			Flat Width			Flat Width		
	18	25	37	18	25	37	18	25	37
07	43	59	72	95	138	165	78	108	131
08	45	62	75	98	140	168	83	113	136
09	47	64	77	100	142	170	87	117	140
10	49	66	79	102	144	172	91	121	144
11	51	68	81	104	146	174	95	125	148
12	53	70	83	106	148	176	99	129	152
13	55	72	85	108	150	178	103	133	156
14	57	74	87	110	152	180	107	137	160
15	59	76	89	112	154	182	111	141	164
16	61	78	91	114	156	184	115	145	168
17	63	80	93	116	158	186	119	149	172
18	65	82	95	118	160	188	123	153	176
19	67	84	97	120	162	190	127	157	180
20	69	86	99	122	164	192	131	161	184
21	71	88	101	124	166	194	135	165	188
22	73	90	103	126	168	196	139	169	192
23	75	92	105	128	170	198	143	173	196
24	77	94	107	130	172	200	147	177	200
25	80	97	110	133	175	203	153	183	206
26	82	99	112	135	177	205	157	187	210
27	84	101	114	137	179	207	161	191	214
28	86	103	116	139	181	209	165	195	218
29	88	105	118	141	183	211	169	199	222
30	91	108	121	144	186	214	175	205	228
31	93	109	122	145	188	215	178	208	231
32	95	111	124	147	190	217	182	212	235
33	97	114	127	150	192	220	187	217	240
34	102	119	132	155	197	225	197	227	250
35	107	124	137	160	202	230	207	237	260
36	113	130	143	166	208	236	219	249	272

CONTOURED TIEBACKS: Single

Width is flat width for a single tieback. Pricing is for a single tieback.

Series	Contoured Plain			Contoured Trim			Contoured Corded		
	Flat Width			Flat Width			Flat Width		
	18	25	37	18	25	37	18	25	37
07	27	35	42	53	74	93	50	75	87
08	29	38	44	56	77	96	55	83	94
09	31	40	46	58	79	98	59	89	100
10	33	42	48	60	81	100	63	95	106
11	35	44	50	62	83	102	67	101	112
12	37	46	52	64	85	104	71	107	118
13	39	48	54	66	87	106	75	113	124
14	41	50	56	68	89	108	79	119	130
15	43	52	58	70	91	110	83	125	136
16	45	54	60	72	93	112	87	131	142
17	47	56	62	74	95	114	91	137	148
18	49	58	64	76	97	116	95	143	154
19	51	60	66	78	99	118	99	149	160
20	53	62	68	80	101	120	103	155	166
21	55	64	70	82	103	122	107	161	172
22	57	66	72	84	105	124	111	167	178
23	59	68	74	86	107	126	115	173	184
24	61	70	76	88	109	128	119	179	190
25	64	73	79	91	112	131	125	188	199
26	66	75	81	93	114	133	129	194	205
27	68	77	83	95	116	135	133	200	211
28	70	79	85	97	118	137	137	206	217
29	72	81	87	99	120	139	141	212	223
30	75	84	90	102	123	142	147	221	232
31	77	85	92	103	124	143	150	225	237
32	79	87	94	105	126	145	154	231	243
33	81	90	96	108	129	148	159	239	250
34	86	95	101	113	134	153	169	254	265
35	91	100	106	118	139	158	179	269	280
36	97	106	112	124	145	164	191	287	298

CONTOURED TIEBACKS: Pair

Width is flat width for each tieback. Pricing is for a pair of tiebacks.

Series	Contoured Plain			Contoured Trim			Contoured Corded		
	Flat Width			Flat Width			Flat Width		
	18	25	37	18	25	37	18	25	37
07	43	59	72	95	138	165	78	119	141
08	45	62	75	98	140	168	83	126	149
09	47	64	77	100	142	170	87	132	155
10	49	66	79	102	144	172	91	138	161
11	51	68	81	104	146	174	95	144	167
12	53	70	83	106	148	176	99	150	173
13	55	72	85	108	150	178	103	156	179
14	57	74	87	110	152	180	107	162	185
15	59	76	89	112	154	182	111	168	191
16	61	78	91	114	156	184	115	174	197
17	63	80	93	116	158	186	119	180	203
18	65	82	95	118	160	188	123	186	209
19	67	84	97	120	162	190	127	192	215
20	69	86	99	122	164	192	131	198	221
21	71	88	101	124	166	194	135	204	227
22	73	90	103	126	168	196	139	210	233
23	75	92	105	128	170	198	143	216	239
24	77	94	107	130	172	200	147	222	245
25	80	97	110	133	175	203	153	231	254
26	82	99	112	135	177	205	157	237	260
27	84	101	114	137	179	207	161	243	266
28	86	103	116	139	181	209	165	249	272
29	88	105	118	141	183	211	169	255	278
30	91	108	121	144	186	214	175	264	287
31	93	109	122	145	188	215	178	269	291
32	95	111	124	147	190	217	182	275	297
33	97	114	127	150	192	220	187	282	305
34	102	119	132	155	197	225	197	297	320
35	107	124	137	160	202	230	207	312	335
36	113	130	143	166	208	236	219	330	353

RIPPLEFOLD: 60% Fullness — Unlined

Chart pricing for butt master or overlap master. Maximum length 114" with Eurohem (exceptions may apply). Sizes and series numbers beyond what is listed in the charts below are available—please submit these quote requests via fax or email.

Series		Finished Pair or Panel Width												
		36"	48"	60"	72"	84"	96"	108"	120"	132"	144"	156"	168"	180"
07	Eurohem	124	155	175	206	237	258	299	309	340	360	402	432	453
08	Eurohem	136	170	193	226	259	283	329	339	372	395	442	475	498
09	Eurohem	146	182	207	242	277	303	353	363	398	423	474	509	534
10	Eurohem	156	194	221	258	295	323	377	387	424	451	506	543	570
11	Eurohem	166	206	235	274	313	343	401	411	450	479	538	577	606
12	Eurohem	176	218	249	290	331	363	425	435	476	507	570	611	642
13	Eurohem	186	230	263	306	349	383	449	459	502	535	602	645	678
14	Eurohem	196	242	277	322	367	403	473	483	528	563	634	679	714
15	Eurohem	206	254	291	338	385	423	497	507	554	591	666	713	750
16	Eurohem	216	266	305	354	403	443	521	531	580	619	698	747	786
17	Eurohem	226	278	319	370	421	463	545	555	606	647	730	781	822
18	Eurohem	236	290	333	386	439	483	569	579	632	675	762	815	858
19	Eurohem	246	302	347	402	457	503	593	603	658	703	794	849	894
20	Eurohem	256	314	361	418	475	523	617	627	684	731	826	883	930
21	Eurohem	266	326	375	434	493	543	641	651	710	759	858	917	966
22	Eurohem	276	338	389	450	511	563	665	675	736	787	890	951	1,002
23	Eurohem	286	350	403	466	529	583	689	699	762	815	922	985	1,038
24	Eurohem	296	362	417	482	547	603	713	723	788	843	954	1,019	1,074
25	Eurohem	311	380	438	506	574	633	749	759	827	885	1,002	1,070	1,128
26	Eurohem	321	392	452	522	592	653	773	783	853	913	1,034	1,104	1,164
27	Eurohem	331	404	466	538	610	673	797	807	879	941	1,066	1,138	1,200
28	Eurohem	341	416	480	554	628	693	821	831	905	969	1,098	1,172	1,236
29	Eurohem	351	428	494	570	646	713	845	855	931	997	1,130	1,206	1,272
30	Eurohem	366	446	515	594	673	743	881	891	970	1,039	1,178	1,257	1,326
31	Eurohem	374	455	525	606	687	758	899	909	990	1,060	1,202	1,282	1,353
32	Eurohem	384	467	539	622	705	778	923	933	1,016	1,088	1,234	1,316	1,389
33	Eurohem	396	482	557	642	727	803	953	963	1,048	1,123	1,274	1,359	1,434
34	Eurohem	421	512	592	682	772	853	1,013	1,023	1,113	1,193	1,354	1,444	1,524
35	Eurohem	446	542	627	722	817	903	1,073	1,083	1,178	1,263	1,434	1,529	1,614
36	Eurohem	476	578	669	770	871	963	1,145	1,155	1,256	1,347	1,530	1,631	1,722

Maximum length 106" with 4" hem (exceptions may apply).

Series		Finished Pair or Panel Width												
		36"	48"	60"	72"	84"	96"	108"	120"	132"	144"	156"	168"	180"
07	Hemmed	134	168	190	223	257	279	323	335	369	391	435	468	491
08	Hemmed	147	183	207	243	280	304	353	365	401	426	475	511	536
09	Hemmed	157	195	221	259	298	324	377	389	427	454	507	545	572
10	Hemmed	167	207	235	275	316	344	401	413	453	482	539	579	608
11	Hemmed	177	219	249	291	334	364	425	437	479	510	571	613	644
12	Hemmed	187	231	263	307	352	384	449	461	505	538	603	647	680
13	Hemmed	197	243	277	323	370	404	473	485	531	566	635	681	716
14	Hemmed	207	255	291	339	388	424	497	509	557	594	667	715	752
15	Hemmed	217	267	305	355	406	444	521	533	583	622	699	749	788
16	Hemmed	227	279	319	371	424	464	545	557	609	650	731	783	824
17	Hemmed	237	291	333	387	442	484	569	581	635	678	763	817	860
18	Hemmed	247	303	347	403	460	504	593	605	661	706	795	851	896
19	Hemmed	257	315	361	419	478	524	617	629	687	734	827	885	932
20	Hemmed	267	327	375	435	496	544	641	653	713	762	859	919	968
21	Hemmed	277	339	389	451	514	564	665	677	739	790	891	953	1,004
22	Hemmed	287	351	403	467	532	584	689	701	765	818	923	987	1,040
23	Hemmed	297	363	417	483	550	604	713	725	791	846	955	1,021	1,076
24	Hemmed	307	375	431	499	568	624	737	749	817	874	987	1,055	1,112
25	Hemmed	322	393	452	523	595	654	773	785	856	916	1,035	1,106	1,166
26	Hemmed	332	405	466	539	613	674	797	809	882	944	1,067	1,140	1,202
27	Hemmed	342	417	480	555	631	694	821	833	908	972	1,099	1,174	1,238
28	Hemmed	352	429	494	571	649	714	845	857	934	1,000	1,131	1,208	1,274
29	Hemmed	362	441	508	587	667	734	869	881	960	1,028	1,163	1,242	1,310
30	Hemmed	377	459	529	611	694	764	905	917	999	1,070	1,211	1,293	1,364
31	Hemmed	384	468	540	623	707	779	923	935	1,019	1,091	1,235	1,318	1,391
32	Hemmed	394	480	554	639	725	799	947	959	1,045	1,119	1,267	1,352	1,427
33	Hemmed	407	495	571	659	748	824	977	989	1,077	1,154	1,307	1,395	1,472
34	Hemmed	432	525	606	699	793	874	1,037	1,049	1,142	1,224	1,387	1,480	1,562
35	Hemmed	457	555	641	739	838	924	1,097	1,109	1,207	1,294	1,467	1,565	1,652
36	Hemmed	487	591	683	787	892	984	1,169	1,181	1,285	1,378	1,563	1,667	1,760

RIPPLEFOLD: 60% Fullness — Lined (Lining 01000)

Chart pricing for butt master or overlap master. Maximum length 114" with Eurohem (exceptions may apply). Sizes and series numbers beyond what is listed in the charts below are available—please submit these quote requests via fax or email.

Series		Finished Pair or Panel Width												
		36"	48"	60"	72"	84"	96"	108"	120"	132"	144"	156"	168"	180"
07	Eurohem	211	260	297	347	396	433	508	520	569	606	681	730	767
08	Eurohem	223	275	315	367	419	458	538	550	602	641	721	772	812
09	Eurohem	233	287	329	383	437	478	562	574	628	669	753	806	848
10	Eurohem	243	299	343	399	455	498	586	598	654	697	785	840	884
11	Eurohem	253	311	357	415	473	518	610	622	680	725	817	874	920
12	Eurohem	263	323	371	431	491	538	634	646	706	753	849	908	956
13	Eurohem	273	335	385	447	509	558	658	670	732	781	881	942	992
14	Eurohem	283	347	399	463	527	578	682	694	758	809	913	976	1,028
15	Eurohem	293	359	413	479	545	598	706	718	784	837	945	1,010	1,064
16	Eurohem	303	371	427	495	563	618	730	742	810	865	977	1,044	1,100
17	Eurohem	313	383	441	511	581	638	754	766	836	893	1,009	1,078	1,136
18	Eurohem	323	395	455	527	599	658	778	790	862	921	1,041	1,112	1,172
19	Eurohem	333	407	469	543	617	678	802	814	888	949	1,073	1,146	1,208
20	Eurohem	343	419	483	559	635	698	826	838	914	977	1,105	1,180	1,244
21	Eurohem	353	431	497	575	653	718	850	862	940	1,005	1,137	1,214	1,280
22	Eurohem	363	443	511	591	671	738	874	886	966	1,033	1,169	1,248	1,316
23	Eurohem	373	455	525	607	689	758	898	910	992	1,061	1,201	1,282	1,352
24	Eurohem	383	467	539	623	707	778	922	934	1,018	1,089	1,233	1,316	1,388
25	Eurohem	398	485	560	647	734	808	958	970	1,057	1,131	1,281	1,367	1,442
26	Eurohem	408	497	574	663	752	828	982	994	1,083	1,159	1,313	1,401	1,478
27	Eurohem	418	509	588	679	770	848	1,006	1,018	1,109	1,187	1,345	1,435	1,514
28	Eurohem	428	521	602	695	788	868	1,030	1,042	1,135	1,215	1,377	1,469	1,550
29	Eurohem	438	533	616	711	806	888	1,054	1,066	1,161	1,243	1,409	1,503	1,586
30	Eurohem	453	551	637	735	833	918	1,090	1,102	1,200	1,285	1,457	1,554	1,640
31	Eurohem	461	560	647	747	846	933	1,108	1,120	1,219	1,306	1,481	1,580	1,667
32	Eurohem	471	572	661	763	864	953	1,132	1,144	1,245	1,334	1,513	1,614	1,703
33	Eurohem	483	587	679	783	887	978	1,162	1,174	1,278	1,369	1,553	1,656	1,748
34	Eurohem	508	617	714	823	932	1,028	1,222	1,234	1,343	1,439	1,633	1,741	1,838
35	Eurohem	533	647	749	863	977	1,078	1,282	1,294	1,408	1,509	1,713	1,826	1,928
36	Eurohem	563	683	791	911	1,031	1,138	1,354	1,366	1,486	1,593	1,809	1,928	2,036

Maximum length 106" with 4" hem (exceptions may apply).

Series		Finished Pair or Panel Width												
		36"	48"	60"	72"	84"	96"	108"	120"	132"	144"	156"	168"	180"
07	Hemmed	221	274	312	365	417	456	533	547	599	638	715	767	806
08	Hemmed	234	289	330	385	440	481	563	577	632	673	755	810	851
09	Hemmed	244	301	344	401	458	501	587	601	658	701	787	844	887
10	Hemmed	254	313	358	417	476	521	611	625	684	729	819	878	923
11	Hemmed	264	325	372	433	494	541	635	649	710	757	851	912	959
12	Hemmed	274	337	386	449	512	561	659	673	736	785	883	946	995
13	Hemmed	284	349	400	465	530	581	683	697	762	813	915	980	1,031
14	Hemmed	294	361	414	481	548	601	707	721	788	841	947	1,014	1,067
15	Hemmed	304	373	428	497	566	621	731	745	814	869	979	1,048	1,103
16	Hemmed	314	385	442	513	584	641	755	769	840	897	1,011	1,082	1,139
17	Hemmed	324	397	456	529	602	661	779	793	866	925	1,043	1,116	1,175
18	Hemmed	334	409	470	545	620	681	803	817	892	953	1,075	1,150	1,211
19	Hemmed	344	421	484	561	638	701	827	841	918	981	1,107	1,184	1,247
20	Hemmed	354	433	498	577	656	721	851	865	944	1,009	1,139	1,218	1,283
21	Hemmed	364	445	512	593	674	741	875	889	970	1,037	1,171	1,252	1,319
22	Hemmed	374	457	526	609	692	761	899	913	996	1,065	1,203	1,286	1,355
23	Hemmed	384	469	540	625	710	781	923	937	1,022	1,093	1,235	1,320	1,391
24	Hemmed	394	481	554	641	728	801	947	961	1,048	1,121	1,267	1,354	1,427
25	Hemmed	409	499	575	665	755	831	983	997	1,087	1,163	1,315	1,405	1,481
26	Hemmed	419	511	589	681	773	851	1,007	1,021	1,113	1,191	1,347	1,439	1,517
27	Hemmed	429	523	603	697	791	871	1,031	1,045	1,139	1,219	1,379	1,473	1,553
28	Hemmed	439	535	617	713	809	891	1,055	1,069	1,165	1,247	1,411	1,507	1,589
29	Hemmed	449	547	631	729	827	911	1,079	1,093	1,191	1,275	1,443	1,541	1,625
30	Hemmed	464	565	652	753	854	941	1,115	1,129	1,230	1,317	1,491	1,592	1,679
31	Hemmed	471	574	662	765	867	956	1,133	1,147	1,249	1,338	1,515	1,617	1,706
32	Hemmed	481	586	676	781	885	976	1,157	1,171	1,275	1,366	1,547	1,651	1,742
33	Hemmed	494	601	694	801	908	1,001	1,187	1,201	1,308	1,401	1,587	1,694	1,787
34	Hemmed	519	631	729	841	953	1,051	1,247	1,261	1,373	1,471	1,667	1,779	1,877
35	Hemmed	544	661	764	881	998	1,101	1,307	1,321	1,438	1,541	1,747	1,864	1,967
36	Hemmed	574	697	806	929	1,052	1,161	1,379	1,393	1,516	1,625	1,843	1,966	2,075

RIPPLEFOLD: 80% Fullness — Unlined

Chart pricing for butt master or overlap master. Maximum length 114" with Eurohem (exceptions may apply). Sizes and series numbers beyond what is listed in the charts below are available—please submit these quote requests via fax or email.

Series		Finished Pair or Panel Width												
		36"	48"	60"	72"	84"	96"	108"	120"	132"	144"	156"	168"	180"
07	Eurohem	134	155	196	227	258	278	309	340	381	402	443	463	505
08	Eurohem	147	170	216	249	283	306	339	372	419	442	485	508	555
09	Eurohem	157	182	232	267	303	328	363	398	449	474	519	544	595
10	Eurohem	167	194	248	285	323	350	387	424	479	506	553	580	635
11	Eurohem	177	206	264	303	343	372	411	450	509	538	587	616	675
12	Eurohem	187	218	280	321	363	394	435	476	539	570	621	652	715
13	Eurohem	197	230	296	339	383	416	459	502	569	602	655	688	755
14	Eurohem	207	242	312	357	403	438	483	528	599	634	689	724	795
15	Eurohem	217	254	328	375	423	460	507	554	629	666	723	760	835
16	Eurohem	227	266	344	393	443	482	531	580	659	698	757	796	875
17	Eurohem	237	278	360	411	463	504	555	606	689	730	791	832	915
18	Eurohem	247	290	376	429	483	526	579	632	719	762	825	868	955
19	Eurohem	257	302	392	447	503	548	603	658	749	794	859	904	995
20	Eurohem	267	314	408	465	523	570	627	684	779	826	893	940	1,035
21	Eurohem	277	326	424	483	543	592	651	710	809	858	927	976	1,075
22	Eurohem	287	338	440	501	563	614	675	736	839	890	961	1,012	1,115
23	Eurohem	297	350	456	519	583	636	699	762	869	922	995	1,048	1,155
24	Eurohem	307	362	472	537	603	658	723	788	899	954	1,029	1,084	1,195
25	Eurohem	322	380	496	564	633	691	759	827	944	1,002	1,080	1,138	1,255
26	Eurohem	332	392	512	582	653	713	783	853	974	1,034	1,114	1,174	1,295
27	Eurohem	342	404	528	600	673	735	807	879	1,004	1,066	1,148	1,210	1,335
28	Eurohem	352	416	544	618	693	757	831	905	1,034	1,098	1,182	1,246	1,375
29	Eurohem	362	428	560	636	713	779	855	931	1,064	1,130	1,216	1,282	1,415
30	Eurohem	377	446	584	663	743	812	891	970	1,109	1,178	1,267	1,336	1,475
31	Eurohem	384	455	596	677	758	828	909	990	1,131	1,202	1,293	1,363	1,505
32	Eurohem	394	467	612	695	778	850	933	1,016	1,161	1,234	1,327	1,399	1,545
33	Eurohem	407	482	632	717	803	878	963	1,048	1,199	1,274	1,369	1,444	1,595
34	Eurohem	432	512	672	762	853	933	1,023	1,113	1,274	1,354	1,454	1,534	1,695
35	Eurohem	457	542	712	807	903	988	1,083	1,178	1,349	1,434	1,539	1,624	1,795
36	Eurohem	487	578	760	861	963	1,054	1,155	1,256	1,439	1,530	1,641	1,732	1,915

Maximum length 106" with 4" hem (exceptions may apply).

Series		Finished Width Pair or Panel												
		36"	48"	60"	72"	84"	96"	108"	120"	132"	144"	156"	168"	180"
07	Hemmed	146	168	212	246	279	301	335	369	413	435	480	502	546
08	Hemmed	158	183	232	268	304	329	365	401	450	475	523	547	596
09	Hemmed	168	195	248	286	324	351	389	427	480	507	557	583	636
10	Hemmed	178	207	264	304	344	373	413	453	510	539	591	619	676
11	Hemmed	188	219	280	322	364	395	437	479	540	571	625	655	716
12	Hemmed	198	231	296	340	384	417	461	505	570	603	659	691	756
13	Hemmed	208	243	312	358	404	439	485	531	600	635	693	727	796
14	Hemmed	218	255	328	376	424	461	509	557	630	667	727	763	836
15	Hemmed	228	267	344	394	444	483	533	583	660	699	761	799	876
16	Hemmed	238	279	360	412	464	505	557	609	690	731	795	835	916
17	Hemmed	248	291	376	430	484	527	581	635	720	763	829	871	956
18	Hemmed	258	303	392	448	504	549	605	661	750	795	863	907	996
19	Hemmed	268	315	408	466	524	571	629	687	780	827	897	943	1,036
20	Hemmed	278	327	424	484	544	593	653	713	810	859	931	979	1,076
21	Hemmed	288	339	440	502	564	615	677	739	840	891	965	1,015	1,116
22	Hemmed	298	351	456	520	584	637	701	765	870	923	999	1,051	1,156
23	Hemmed	308	363	472	538	604	659	725	791	900	955	1,033	1,087	1,196
24	Hemmed	318	375	488	556	624	681	749	817	930	987	1,067	1,123	1,236
25	Hemmed	333	393	512	583	654	714	785	856	975	1,035	1,118	1,177	1,296
26	Hemmed	343	405	528	601	674	736	809	882	1,005	1,067	1,152	1,213	1,336
27	Hemmed	353	417	544	619	694	758	833	908	1,035	1,099	1,186	1,249	1,376
28	Hemmed	363	429	560	637	714	780	857	934	1,065	1,131	1,220	1,285	1,416
29	Hemmed	373	441	576	655	734	802	881	960	1,095	1,163	1,254	1,321	1,456
30	Hemmed	388	459	600	682	764	835	917	999	1,140	1,211	1,305	1,375	1,516
31	Hemmed	396	468	612	696	779	851	935	1,019	1,163	1,235	1,330	1,402	1,546
32	Hemmed	406	480	628	714	799	873	959	1,045	1,193	1,267	1,364	1,438	1,586
33	Hemmed	418	495	648	736	824	901	989	1,077	1,230	1,307	1,407	1,483	1,636
34	Hemmed	443	525	688	781	874	956	1,049	1,142	1,305	1,387	1,492	1,573	1,736
35	Hemmed	468	555	728	826	924	1,011	1,109	1,207	1,380	1,467	1,577	1,663	1,836
36	Hemmed	498	591	776	880	984	1,077	1,181	1,285	1,470	1,563	1,679	1,771	1,956

RIPPLEFOLD: 80% Fullness — Lined (Lining 01000)

Chart pricing for butt master or overlap master. Maximum length 114" with Eurohem (exceptions may apply). Sizes and series numbers beyond what is listed in the charts below are available—please submit these quote requests via fax or email.

Series		Finished Pair or Panel Width												
		36"	48"	60"	72"	84"	96"	108"	120"	132"	144"	156"	168"	180"
07	Eurohem	223	260	334	384	433	470	520	569	643	681	742	779	854
08	Eurohem	235	275	354	406	458	498	550	602	681	721	785	824	904
09	Eurohem	245	287	370	424	478	520	574	628	711	753	819	860	944
10	Eurohem	255	299	386	442	498	542	598	654	741	785	853	896	984
11	Eurohem	265	311	402	460	518	564	622	680	771	817	887	932	1,024
12	Eurohem	275	323	418	478	538	586	646	706	801	849	921	968	1,064
13	Eurohem	285	335	434	496	558	608	670	732	831	881	955	1,004	1,104
14	Eurohem	295	347	450	514	578	630	694	758	861	913	989	1,040	1,144
15	Eurohem	305	359	466	532	598	652	718	784	891	945	1,023	1,076	1,184
16	Eurohem	315	371	482	550	618	674	742	810	921	977	1,057	1,112	1,224
17	Eurohem	325	383	498	568	638	696	766	836	951	1,009	1,091	1,148	1,264
18	Eurohem	335	395	514	586	658	718	790	862	981	1,041	1,125	1,184	1,304
19	Eurohem	345	407	530	604	678	740	814	888	1,011	1,073	1,159	1,220	1,344
20	Eurohem	355	419	546	622	698	762	838	914	1,041	1,105	1,193	1,256	1,384
21	Eurohem	365	431	562	640	718	784	862	940	1,071	1,137	1,227	1,292	1,424
22	Eurohem	375	443	578	658	738	806	886	966	1,101	1,169	1,261	1,328	1,464
23	Eurohem	385	455	594	676	758	828	910	992	1,131	1,201	1,295	1,364	1,504
24	Eurohem	395	467	610	694	778	850	934	1,018	1,161	1,233	1,329	1,400	1,544
25	Eurohem	410	485	634	721	808	883	970	1,057	1,206	1,281	1,380	1,454	1,604
26	Eurohem	420	497	650	739	828	905	994	1,083	1,236	1,313	1,414	1,490	1,644
27	Eurohem	430	509	666	757	848	927	1,018	1,109	1,266	1,345	1,448	1,526	1,684
28	Eurohem	440	521	682	775	868	949	1,042	1,135	1,296	1,377	1,482	1,562	1,724
29	Eurohem	450	533	698	793	888	971	1,066	1,161	1,326	1,409	1,516	1,598	1,764
30	Eurohem	465	551	722	820	918	1,004	1,102	1,200	1,371	1,457	1,567	1,652	1,824
31	Eurohem	473	560	734	834	933	1,020	1,120	1,219	1,393	1,481	1,592	1,679	1,854
32	Eurohem	483	572	750	852	953	1,042	1,144	1,245	1,423	1,513	1,626	1,715	1,894
33	Eurohem	495	587	770	874	978	1,070	1,174	1,278	1,461	1,553	1,669	1,760	1,944
34	Eurohem	520	617	810	919	1,028	1,125	1,234	1,343	1,536	1,633	1,754	1,850	2,044
35	Eurohem	545	647	850	964	1,078	1,180	1,294	1,408	1,611	1,713	1,839	1,940	2,144
36	Eurohem	575	683	898	1,018	1,138	1,246	1,366	1,486	1,701	1,809	1,941	2,048	2,264

Maximum length 106" with 4" hem (exceptions may apply).

Series		Finished Width Pair or Panel												
		36"	48"	60"	72"	84"	96"	108"	120"	132"	144"	156"	168"	180"
07	Hemmed	235	274	351	403	456	494	547	599	676	715	781	820	897
08	Hemmed	247	289	371	426	481	522	577	632	714	755	824	865	947
09	Hemmed	257	301	387	444	501	544	601	658	744	787	858	901	987
10	Hemmed	267	313	403	462	521	566	625	684	774	819	892	937	1,027
11	Hemmed	277	325	419	480	541	588	649	710	804	851	926	973	1,067
12	Hemmed	287	337	435	498	561	610	673	736	834	883	960	1,009	1,107
13	Hemmed	297	349	451	516	581	632	697	762	864	915	994	1,045	1,147
14	Hemmed	307	361	467	534	601	654	721	788	894	947	1,028	1,081	1,187
15	Hemmed	317	373	483	552	621	676	745	814	924	979	1,062	1,117	1,227
16	Hemmed	327	385	499	570	641	698	769	840	954	1,011	1,096	1,153	1,267
17	Hemmed	337	397	515	588	661	720	793	866	984	1,043	1,130	1,189	1,307
18	Hemmed	347	409	531	606	681	742	817	892	1,014	1,075	1,164	1,225	1,347
19	Hemmed	357	421	547	624	701	764	841	918	1,044	1,107	1,198	1,261	1,387
20	Hemmed	367	433	563	642	721	786	865	944	1,074	1,139	1,232	1,297	1,427
21	Hemmed	377	445	579	660	741	808	889	970	1,104	1,171	1,266	1,333	1,467
22	Hemmed	387	457	595	678	761	830	913	996	1,134	1,203	1,300	1,369	1,507
23	Hemmed	397	469	611	696	781	852	937	1,022	1,164	1,235	1,334	1,405	1,547
24	Hemmed	407	481	627	714	801	874	961	1,048	1,194	1,267	1,368	1,441	1,587
25	Hemmed	422	499	651	741	831	907	997	1,087	1,239	1,315	1,419	1,495	1,647
26	Hemmed	432	511	667	759	851	929	1,021	1,113	1,269	1,347	1,453	1,531	1,687
27	Hemmed	442	523	683	777	871	951	1,045	1,139	1,299	1,379	1,487	1,567	1,727
28	Hemmed	452	535	699	795	891	973	1,069	1,165	1,329	1,411	1,521	1,603	1,767
29	Hemmed	462	547	715	813	911	995	1,093	1,191	1,359	1,443	1,555	1,639	1,807
30	Hemmed	477	565	739	840	941	1,028	1,129	1,230	1,404	1,491	1,606	1,693	1,867
31	Hemmed	485	574	751	853	956	1,044	1,147	1,249	1,426	1,515	1,631	1,720	1,897
32	Hemmed	495	586	767	871	976	1,066	1,171	1,275	1,456	1,547	1,665	1,756	1,937
33	Hemmed	507	601	787	894	1,001	1,094	1,201	1,308	1,494	1,587	1,708	1,801	1,987
34	Hemmed	532	631	827	939	1,051	1,149	1,261	1,373	1,569	1,667	1,793	1,891	2,087
35	Hemmed	557	661	867	984	1,101	1,204	1,321	1,438	1,644	1,747	1,878	1,981	2,187
36	Hemmed	587	697	915	1,038	1,161	1,270	1,393	1,516	1,734	1,843	1,980	2,089	2,307

RIPPLEFOLD: 100% Fullness — Unlined

Chart pricing for butt master or overlap master. Maximum length 114" with Eurohem (exceptions may apply). Sizes and series numbers beyond what is listed in the charts below are available—please submit these quote requests via fax or email.

Series		Finished Pair or Panel Width												
		36"	48"	60"	72"	84"	96"	108"	120"	132"	144"	156"	168"	180"
07	Eurohem	134	175	206	247	278	309	340	381	412	453	484	535	545
08	Eurohem	147	193	226	272	306	339	372	419	452	498	531	588	598
09	Eurohem	157	207	242	292	328	363	398	449	484	534	569	630	640
10	Eurohem	167	221	258	312	350	387	424	479	516	570	607	672	682
11	Eurohem	177	235	274	332	372	411	450	509	548	606	645	714	724
12	Eurohem	187	249	290	352	394	435	476	539	580	642	683	756	766
13	Eurohem	197	263	306	372	416	459	502	569	612	678	721	798	808
14	Eurohem	207	277	322	392	438	483	528	599	644	714	759	840	850
15	Eurohem	217	291	338	412	460	507	554	629	676	750	797	882	892
16	Eurohem	227	305	354	432	482	531	580	659	708	786	835	924	934
17	Eurohem	237	319	370	452	504	555	606	689	740	822	873	966	976
18	Eurohem	247	333	386	472	526	579	632	719	772	858	911	1,008	1,018
19	Eurohem	257	347	402	492	548	603	658	749	804	894	949	1,050	1,060
20	Eurohem	267	361	418	512	570	627	684	779	836	930	987	1,092	1,102
21	Eurohem	277	375	434	532	592	651	710	809	868	966	1,025	1,134	1,144
22	Eurohem	287	389	450	552	614	675	736	839	900	1,002	1,063	1,176	1,186
23	Eurohem	297	403	466	572	636	699	762	869	932	1,038	1,101	1,218	1,228
24	Eurohem	307	417	482	592	658	723	788	899	964	1,074	1,139	1,260	1,270
25	Eurohem	322	438	506	622	691	759	827	944	1,012	1,128	1,196	1,323	1,333
26	Eurohem	332	452	522	642	713	783	853	974	1,044	1,164	1,234	1,365	1,375
27	Eurohem	342	466	538	662	735	807	879	1,004	1,076	1,200	1,272	1,407	1,417
28	Eurohem	352	480	554	682	757	831	905	1,034	1,108	1,236	1,310	1,449	1,459
29	Eurohem	362	494	570	702	779	855	931	1,064	1,140	1,272	1,348	1,491	1,501
30	Eurohem	377	515	594	732	812	891	970	1,109	1,188	1,326	1,405	1,554	1,564
31	Eurohem	384	525	606	747	828	909	990	1,131	1,212	1,353	1,434	1,585	1,595
32	Eurohem	394	539	622	767	850	933	1,016	1,161	1,244	1,389	1,472	1,627	1,637
33	Eurohem	407	557	642	792	878	963	1,048	1,199	1,284	1,434	1,519	1,680	1,690
34	Eurohem	432	592	682	842	933	1,023	1,113	1,274	1,364	1,524	1,614	1,785	1,795
35	Eurohem	457	627	722	892	988	1,083	1,178	1,349	1,444	1,614	1,709	1,890	1,900
36	Eurohem	487	669	770	952	1,054	1,155	1,256	1,439	1,540	1,722	1,823	2,016	2,026

Maximum length 106" with 4" hem (exceptions may apply).

Series		Finished Pair or Panel Width												
		36"	48"	60"	72"	84"	96"	108"	120"	132"	144"	156"	168"	180"
07	Hemmed	146	190	223	268	301	335	369	413	446	491	524	580	592
08	Hemmed	158	207	243	293	329	365	401	450	486	536	572	632	644
09	Hemmed	168	221	259	313	351	389	427	480	518	572	610	674	686
10	Hemmed	178	235	275	333	373	413	453	510	550	608	648	716	728
11	Hemmed	188	249	291	353	395	437	479	540	582	644	686	758	770
12	Hemmed	198	263	307	373	417	461	505	570	614	680	724	800	812
13	Hemmed	208	277	323	393	439	485	531	600	646	716	762	842	854
14	Hemmed	218	291	339	413	461	509	557	630	678	752	800	884	896
15	Hemmed	228	305	355	433	483	533	583	660	710	788	838	926	938
16	Hemmed	238	319	371	453	505	557	609	690	742	824	876	968	980
17	Hemmed	248	333	387	473	527	581	635	720	774	860	914	1,010	1,022
18	Hemmed	258	347	403	493	549	605	661	750	806	896	952	1,052	1,064
19	Hemmed	268	361	419	513	571	629	687	780	838	932	990	1,094	1,106
20	Hemmed	278	375	435	533	593	653	713	810	870	968	1,028	1,136	1,148
21	Hemmed	288	389	451	553	615	677	739	840	902	1,004	1,066	1,178	1,190
22	Hemmed	298	403	467	573	637	701	765	870	934	1,040	1,104	1,220	1,232
23	Hemmed	308	417	483	593	659	725	791	900	966	1,076	1,142	1,262	1,274
24	Hemmed	318	431	499	613	681	749	817	930	998	1,112	1,180	1,304	1,316
25	Hemmed	333	452	523	643	714	785	856	975	1,046	1,166	1,237	1,367	1,379
26	Hemmed	343	466	539	663	736	809	882	1,005	1,078	1,202	1,275	1,409	1,421
27	Hemmed	353	480	555	683	758	833	908	1,035	1,110	1,238	1,313	1,451	1,463
28	Hemmed	363	494	571	703	780	857	934	1,065	1,142	1,274	1,351	1,493	1,505
29	Hemmed	373	508	587	723	802	881	960	1,095	1,174	1,310	1,389	1,535	1,547
30	Hemmed	388	529	611	753	835	917	999	1,140	1,222	1,364	1,446	1,598	1,610
31	Hemmed	396	540	623	768	851	935	1,019	1,163	1,246	1,391	1,474	1,630	1,642
32	Hemmed	406	554	639	788	873	959	1,045	1,193	1,278	1,427	1,512	1,672	1,684
33	Hemmed	418	571	659	813	901	989	1,077	1,230	1,318	1,472	1,560	1,724	1,736
34	Hemmed	443	606	699	863	956	1,049	1,142	1,305	1,398	1,562	1,655	1,829	1,841
35	Hemmed	468	641	739	913	1,011	1,109	1,207	1,380	1,478	1,652	1,750	1,934	1,946
36	Hemmed	498	683	787	973	1,077	1,181	1,285	1,470	1,574	1,760	1,864	2,060	2,072

RIPPLEFOLD: 100% Fullness — Lined (Lining 01000)

Chart pricing for butt master or overlap master. Maximum length 114" with Eurohem (exceptions may apply). Sizes and series numbers beyond what is listed in the charts below are available—please submit these quote requests via fax or email.

Series		Finished Pair or Panel Width												
		36"	48"	60"	72"	84"	96"	108"	120"	132"	144"	156"	168"	180"
07	Eurohem	223	297	347	421	470	520	569	643	693	767	817	903	915
08	Eurohem	235	315	367	446	498	550	602	681	733	812	864	956	968
09	Eurohem	245	329	383	466	520	574	628	711	765	848	902	998	1,010
10	Eurohem	255	343	399	486	542	598	654	741	797	884	940	1,040	1,052
11	Eurohem	265	357	415	506	564	622	680	771	829	920	978	1,082	1,094
12	Eurohem	275	371	431	526	586	646	706	801	861	956	1,016	1,124	1,136
13	Eurohem	285	385	447	546	608	670	732	831	893	992	1,054	1,166	1,178
14	Eurohem	295	399	463	566	630	694	758	861	925	1,028	1,092	1,208	1,220
15	Eurohem	305	413	479	586	652	718	784	891	957	1,064	1,130	1,250	1,262
16	Eurohem	315	427	495	606	674	742	810	921	989	1,100	1,168	1,292	1,304
17	Eurohem	325	441	511	626	696	766	836	951	1,021	1,136	1,206	1,334	1,346
18	Eurohem	335	455	527	646	718	790	862	981	1,053	1,172	1,244	1,376	1,388
19	Eurohem	345	469	543	666	740	814	888	1,011	1,085	1,208	1,282	1,418	1,430
20	Eurohem	355	483	559	686	762	838	914	1,041	1,117	1,244	1,320	1,460	1,472
21	Eurohem	365	497	575	706	784	862	940	1,071	1,149	1,280	1,358	1,502	1,514
22	Eurohem	375	511	591	726	806	886	966	1,101	1,181	1,316	1,396	1,544	1,556
23	Eurohem	385	525	607	746	828	910	992	1,131	1,213	1,352	1,434	1,586	1,598
24	Eurohem	395	539	623	766	850	934	1,018	1,161	1,245	1,388	1,472	1,628	1,640
25	Eurohem	410	560	647	796	883	970	1,057	1,206	1,293	1,442	1,529	1,691	1,703
26	Eurohem	420	574	663	816	905	994	1,083	1,236	1,325	1,478	1,567	1,733	1,745
27	Eurohem	430	588	679	836	927	1,018	1,109	1,266	1,357	1,514	1,605	1,775	1,787
28	Eurohem	440	602	695	856	949	1,042	1,135	1,296	1,389	1,550	1,643	1,817	1,829
29	Eurohem	450	616	711	876	971	1,066	1,161	1,326	1,421	1,586	1,681	1,859	1,871
30	Eurohem	465	637	735	906	1,004	1,102	1,200	1,371	1,469	1,640	1,738	1,922	1,934
31	Eurohem	473	647	747	921	1,020	1,120	1,219	1,393	1,493	1,667	1,767	1,953	1,965
32	Eurohem	483	661	763	941	1,042	1,144	1,245	1,423	1,525	1,703	1,805	1,995	2,007
33	Eurohem	495	679	783	966	1,070	1,174	1,278	1,461	1,565	1,748	1,852	2,048	2,060
34	Eurohem	520	714	823	1,016	1,125	1,234	1,343	1,536	1,645	1,838	1,947	2,153	2,165
35	Eurohem	545	749	863	1,066	1,180	1,294	1,408	1,611	1,725	1,928	2,042	2,258	2,270
36	Eurohem	575	791	911	1,126	1,246	1,366	1,486	1,701	1,821	2,036	2,156	2,384	2,396

Maximum length 106" with 4" hem (exceptions may apply).

Series		Finished Pair or Panel Width												
		36"	48"	60"	72"	84"	96"	108"	120"	132"	144"	156"	168"	180"
07	Hemmed	235	312	365	442	494	547	599	676	729	806	859	950	963
08	Hemmed	247	330	385	467	522	577	632	714	769	851	906	1,002	1,016
09	Hemmed	257	344	401	487	544	601	658	744	801	887	944	1,044	1,058
10	Hemmed	267	358	417	507	566	625	684	774	833	923	982	1,086	1,100
11	Hemmed	277	372	433	527	588	649	710	804	865	959	1,020	1,128	1,142
12	Hemmed	287	386	449	547	610	673	736	834	897	995	1,058	1,170	1,184
13	Hemmed	297	400	465	567	632	697	762	864	929	1,031	1,096	1,212	1,226
14	Hemmed	307	414	481	587	654	721	788	894	961	1,067	1,134	1,254	1,268
15	Hemmed	317	428	497	607	676	745	814	924	993	1,103	1,172	1,296	1,310
16	Hemmed	327	442	513	627	698	769	840	954	1,025	1,139	1,210	1,338	1,352
17	Hemmed	337	456	529	647	720	793	866	984	1,057	1,175	1,248	1,380	1,394
18	Hemmed	347	470	545	667	742	817	892	1,014	1,089	1,211	1,286	1,422	1,436
19	Hemmed	357	484	561	687	764	841	918	1,044	1,121	1,247	1,324	1,464	1,478
20	Hemmed	367	498	577	707	786	865	944	1,074	1,153	1,283	1,362	1,506	1,520
21	Hemmed	377	512	593	727	808	889	970	1,104	1,185	1,319	1,400	1,548	1,562
22	Hemmed	387	526	609	747	830	913	996	1,134	1,217	1,355	1,438	1,590	1,604
23	Hemmed	397	540	625	767	852	937	1,022	1,164	1,249	1,391	1,476	1,632	1,646
24	Hemmed	407	554	641	787	874	961	1,048	1,194	1,281	1,427	1,514	1,674	1,688
25	Hemmed	422	575	665	817	907	997	1,087	1,239	1,329	1,481	1,571	1,737	1,751
26	Hemmed	432	589	681	837	929	1,021	1,113	1,269	1,361	1,517	1,609	1,779	1,793
27	Hemmed	442	603	697	857	951	1,045	1,139	1,299	1,393	1,553	1,647	1,821	1,835
28	Hemmed	452	617	713	877	973	1,069	1,165	1,329	1,425	1,589	1,685	1,863	1,877
29	Hemmed	462	631	729	897	995	1,093	1,191	1,359	1,457	1,625	1,723	1,905	1,919
30	Hemmed	477	652	753	927	1,028	1,129	1,230	1,404	1,505	1,679	1,780	1,968	1,982
31	Hemmed	485	662	765	942	1,044	1,147	1,249	1,426	1,529	1,706	1,809	2,000	2,013
32	Hemmed	495	676	781	962	1,066	1,171	1,275	1,456	1,561	1,742	1,847	2,042	2,055
33	Hemmed	507	694	801	987	1,094	1,201	1,308	1,494	1,601	1,787	1,894	2,094	2,108
34	Hemmed	532	729	841	1,037	1,149	1,261	1,373	1,569	1,681	1,877	1,989	2,199	2,213
35	Hemmed	557	764	881	1,087	1,204	1,321	1,438	1,644	1,761	1,967	2,084	2,304	2,318
36	Hemmed	587	806	929	1,147	1,270	1,393	1,516	1,734	1,857	2,075	2,198	2,430	2,444

RIPPLEFOLD: 120% Fullness — Unlined

Chart pricing for butt master or overlap master. Maximum length 114" with Eurohem (exceptions may apply). Sizes and series numbers beyond what is listed in the charts below are available—please submit these quote requests via fax or email.

Series		Finished Pair or Panel Width												
		36"	48"	60"	72"	84"	96"	108"	120"	132"	144"	156"	168"	180"
07	Eurohem	155	196	237	278	309	360	391	432	463	505	545	587	618
08	Eurohem	170	216	259	306	339	395	429	475	508	555	598	644	678
09	Eurohem	182	232	277	328	363	423	459	509	544	595	640	690	726
10	Eurohem	194	248	295	350	387	451	489	543	580	635	682	736	774
11	Eurohem	206	264	313	372	411	479	519	577	616	675	724	782	822
12	Eurohem	218	280	331	394	435	507	549	611	652	715	766	828	870
13	Eurohem	230	296	349	416	459	535	579	645	688	755	808	874	918
14	Eurohem	242	312	367	438	483	563	609	679	724	795	850	920	966
15	Eurohem	254	328	385	460	507	591	639	713	760	835	892	966	1,014
16	Eurohem	266	344	403	482	531	619	669	747	796	875	934	1,012	1,062
17	Eurohem	278	360	421	504	555	647	699	781	832	915	976	1,058	1,110
18	Eurohem	290	376	439	526	579	675	729	815	868	955	1,018	1,104	1,158
19	Eurohem	302	392	457	548	603	703	759	849	904	995	1,060	1,150	1,206
20	Eurohem	314	408	475	570	627	731	789	883	940	1,035	1,102	1,196	1,254
21	Eurohem	326	424	493	592	651	759	819	917	976	1,075	1,144	1,242	1,302
22	Eurohem	338	440	511	614	675	787	849	951	1,012	1,115	1,186	1,288	1,350
23	Eurohem	350	456	529	636	699	815	879	985	1,048	1,155	1,228	1,334	1,398
24	Eurohem	362	472	547	658	723	843	909	1,019	1,084	1,195	1,270	1,380	1,446
25	Eurohem	380	496	574	691	759	885	954	1,070	1,138	1,255	1,333	1,449	1,518
26	Eurohem	392	512	592	713	783	913	984	1,104	1,174	1,295	1,375	1,495	1,566
27	Eurohem	404	528	610	735	807	941	1,014	1,138	1,210	1,335	1,417	1,541	1,614
28	Eurohem	416	544	628	757	831	969	1,044	1,172	1,246	1,375	1,459	1,587	1,662
29	Eurohem	428	560	646	779	855	997	1,074	1,206	1,282	1,415	1,501	1,633	1,710
30	Eurohem	446	584	673	812	891	1,039	1,119	1,257	1,336	1,475	1,564	1,702	1,782
31	Eurohem	455	596	687	828	909	1,060	1,141	1,282	1,363	1,505	1,595	1,737	1,818
32	Eurohem	467	612	705	850	933	1,088	1,171	1,316	1,399	1,545	1,637	1,783	1,866
33	Eurohem	482	632	727	878	963	1,123	1,209	1,359	1,444	1,595	1,690	1,840	1,926
34	Eurohem	512	672	772	933	1,023	1,193	1,284	1,444	1,534	1,695	1,795	1,955	2,046
35	Eurohem	542	712	817	988	1,083	1,263	1,359	1,529	1,624	1,795	1,900	2,070	2,166
36	Eurohem	578	760	871	1,054	1,155	1,347	1,449	1,631	1,732	1,915	2,026	2,208	2,310

Maximum length 106" with 4" hem (exceptions may apply).

Series		Finished Pair or Panel Width												
		36"	48"	60"	72"	84"	96"	108"	120"	132"	144"	156"	168"	180"
07	Hemmed	168	212	257	301	335	391	424	468	502	546	592	636	669
08	Hemmed	183	232	280	329	365	426	462	511	547	596	644	693	729
09	Hemmed	195	248	298	351	389	454	492	545	583	636	686	739	777
10	Hemmed	207	264	316	373	413	482	522	579	619	676	728	785	825
11	Hemmed	219	280	334	395	437	510	552	613	655	716	770	831	873
12	Hemmed	231	296	352	417	461	538	582	647	691	756	812	877	921
13	Hemmed	243	312	370	439	485	566	612	681	727	796	854	923	969
14	Hemmed	255	328	388	461	509	594	642	715	763	836	896	969	1,017
15	Hemmed	267	344	406	483	533	622	672	749	799	876	938	1,015	1,065
16	Hemmed	279	360	424	505	557	650	702	783	835	916	980	1,061	1,113
17	Hemmed	291	376	442	527	581	678	732	817	871	956	1,022	1,107	1,161
18	Hemmed	303	392	460	549	605	706	762	851	907	996	1,064	1,153	1,209
19	Hemmed	315	408	478	571	629	734	792	885	943	1,036	1,106	1,199	1,257
20	Hemmed	327	424	496	593	653	762	822	919	979	1,076	1,148	1,245	1,305
21	Hemmed	339	440	514	615	677	790	852	953	1,015	1,116	1,190	1,291	1,353
22	Hemmed	351	456	532	637	701	818	882	987	1,051	1,156	1,232	1,337	1,401
23	Hemmed	363	472	550	659	725	846	912	1,021	1,087	1,196	1,274	1,383	1,449
24	Hemmed	375	488	568	681	749	874	942	1,055	1,123	1,236	1,316	1,429	1,497
25	Hemmed	393	512	595	714	785	916	987	1,106	1,177	1,296	1,379	1,498	1,569
26	Hemmed	405	528	613	736	809	944	1,017	1,140	1,213	1,336	1,421	1,544	1,617
27	Hemmed	417	544	631	758	833	972	1,047	1,174	1,249	1,376	1,463	1,590	1,665
28	Hemmed	429	560	649	780	857	1,000	1,077	1,208	1,285	1,416	1,505	1,636	1,713
29	Hemmed	441	576	667	802	881	1,028	1,107	1,242	1,321	1,456	1,547	1,682	1,761
30	Hemmed	459	600	694	835	917	1,070	1,152	1,293	1,375	1,516	1,610	1,751	1,833
31	Hemmed	468	612	707	851	935	1,091	1,174	1,318	1,402	1,546	1,642	1,786	1,869
32	Hemmed	480	628	725	873	959	1,119	1,204	1,352	1,438	1,586	1,684	1,832	1,917
33	Hemmed	495	648	748	901	989	1,154	1,242	1,395	1,483	1,636	1,736	1,889	1,977
34	Hemmed	525	688	793	956	1,049	1,224	1,317	1,480	1,573	1,736	1,841	2,004	2,097
35	Hemmed	555	728	838	1,011	1,109	1,294	1,392	1,565	1,663	1,836	1,946	2,119	2,217
36	Hemmed	591	776	892	1,077	1,181	1,378	1,482	1,667	1,771	1,956	2,072	2,257	2,361

RIPPLEFOLD: 120% Fullness — Lined (Lining 01000)

Chart pricing for butt master or overlap master. Maximum length 114" with Eurohem (exceptions may apply). Sizes and series numbers beyond what is listed in the charts below are available—please submit these quote requests via fax or email.

Series		Finished Pair or Panel Width												
		36"	48"	60"	72"	84"	96"	108"	120"	132"	144"	156"	168"	180"
07	Eurohem	260	334	396	470	520	606	656	730	779	854	915	990	1,039
08	Eurohem	275	354	419	498	550	641	693	772	824	904	968	1,047	1,099
09	Eurohem	287	370	437	520	574	669	723	806	860	944	1,010	1,093	1,147
10	Eurohem	299	386	455	542	598	697	753	840	896	984	1,052	1,139	1,195
11	Eurohem	311	402	473	564	622	725	783	874	932	1,024	1,094	1,185	1,243
12	Eurohem	323	418	491	586	646	753	813	908	968	1,064	1,136	1,231	1,291
13	Eurohem	335	434	509	608	670	781	843	942	1,004	1,104	1,178	1,277	1,339
14	Eurohem	347	450	527	630	694	809	873	976	1,040	1,144	1,220	1,323	1,387
15	Eurohem	359	466	545	652	718	837	903	1,010	1,076	1,184	1,262	1,369	1,435
16	Eurohem	371	482	563	674	742	865	933	1,044	1,112	1,224	1,304	1,415	1,483
17	Eurohem	383	498	581	696	766	893	963	1,078	1,148	1,264	1,346	1,461	1,531
18	Eurohem	395	514	599	718	790	921	993	1,112	1,184	1,304	1,388	1,507	1,579
19	Eurohem	407	530	617	740	814	949	1,023	1,146	1,220	1,344	1,430	1,553	1,627
20	Eurohem	419	546	635	762	838	977	1,053	1,180	1,256	1,384	1,472	1,599	1,675
21	Eurohem	431	562	653	784	862	1,005	1,083	1,214	1,292	1,424	1,514	1,645	1,723
22	Eurohem	443	578	671	806	886	1,033	1,113	1,248	1,328	1,464	1,556	1,691	1,771
23	Eurohem	455	594	689	828	910	1,061	1,143	1,282	1,364	1,504	1,598	1,737	1,819
24	Eurohem	467	610	707	850	934	1,089	1,173	1,316	1,400	1,544	1,640	1,783	1,867
25	Eurohem	485	634	734	883	970	1,131	1,218	1,367	1,454	1,604	1,703	1,852	1,939
26	Eurohem	497	650	752	905	994	1,159	1,248	1,401	1,490	1,644	1,745	1,898	1,987
27	Eurohem	509	666	770	927	1,018	1,187	1,278	1,435	1,526	1,684	1,787	1,944	2,035
28	Eurohem	521	682	788	949	1,042	1,215	1,308	1,469	1,562	1,724	1,829	1,990	2,083
29	Eurohem	533	698	806	971	1,066	1,243	1,338	1,503	1,598	1,764	1,871	2,036	2,131
30	Eurohem	551	722	833	1,004	1,102	1,285	1,383	1,554	1,652	1,824	1,934	2,105	2,203
31	Eurohem	560	734	846	1,020	1,120	1,306	1,406	1,580	1,679	1,854	1,965	2,140	2,239
32	Eurohem	572	750	864	1,042	1,144	1,334	1,436	1,614	1,715	1,894	2,007	2,186	2,287
33	Eurohem	587	770	887	1,070	1,174	1,369	1,473	1,656	1,760	1,944	2,060	2,243	2,347
34	Eurohem	617	810	932	1,125	1,234	1,439	1,548	1,741	1,850	2,044	2,165	2,358	2,467
35	Eurohem	647	850	977	1,180	1,294	1,509	1,623	1,826	1,940	2,144	2,270	2,473	2,587
36	Eurohem	683	898	1,031	1,246	1,366	1,593	1,713	1,928	2,048	2,264	2,396	2,611	2,731

Maximum length 106" with 4" hem (exceptions may apply).

Series		Finished Pair or Panel Width												
		36"	48"	60"	72"	84"	96"	108"	120"	132"	144"	156"	168"	180"
07	Hemmed	274	351	417	494	547	638	690	767	820	897	963	1,041	1,093
08	Hemmed	289	371	440	522	577	673	728	810	865	947	1,016	1,098	1,153
09	Hemmed	301	387	458	544	601	701	758	844	901	987	1,058	1,144	1,201
10	Hemmed	313	403	476	566	625	729	788	878	937	1,027	1,100	1,190	1,249
11	Hemmed	325	419	494	588	649	757	818	912	973	1,067	1,142	1,236	1,297
12	Hemmed	337	435	512	610	673	785	848	946	1,009	1,107	1,184	1,282	1,345
13	Hemmed	349	451	530	632	697	813	878	980	1,045	1,147	1,226	1,328	1,393
14	Hemmed	361	467	548	654	721	841	908	1,014	1,081	1,187	1,268	1,374	1,441
15	Hemmed	373	483	566	676	745	869	938	1,048	1,117	1,227	1,310	1,420	1,489
16	Hemmed	385	499	584	698	769	897	968	1,082	1,153	1,267	1,352	1,466	1,537
17	Hemmed	397	515	602	720	793	925	998	1,116	1,189	1,307	1,394	1,512	1,585
18	Hemmed	409	531	620	742	817	953	1,028	1,150	1,225	1,347	1,436	1,558	1,633
19	Hemmed	421	547	638	764	841	981	1,058	1,184	1,261	1,387	1,478	1,604	1,681
20	Hemmed	433	563	656	786	865	1,009	1,088	1,218	1,297	1,427	1,520	1,650	1,729
21	Hemmed	445	579	674	808	889	1,037	1,118	1,252	1,333	1,467	1,562	1,696	1,777
22	Hemmed	457	595	692	830	913	1,065	1,148	1,286	1,369	1,507	1,604	1,742	1,825
23	Hemmed	469	611	710	852	937	1,093	1,178	1,320	1,405	1,547	1,646	1,788	1,873
24	Hemmed	481	627	728	874	961	1,121	1,208	1,354	1,441	1,587	1,688	1,834	1,921
25	Hemmed	499	651	755	907	997	1,163	1,253	1,405	1,495	1,647	1,751	1,903	1,993
26	Hemmed	511	667	773	929	1,021	1,191	1,283	1,439	1,531	1,687	1,793	1,949	2,041
27	Hemmed	523	683	791	951	1,045	1,219	1,313	1,473	1,567	1,727	1,835	1,995	2,089
28	Hemmed	535	699	809	973	1,069	1,247	1,343	1,507	1,603	1,767	1,877	2,041	2,137
29	Hemmed	547	715	827	995	1,093	1,275	1,373	1,541	1,639	1,807	1,919	2,087	2,185
30	Hemmed	565	739	854	1,028	1,129	1,317	1,418	1,592	1,693	1,867	1,982	2,156	2,257
31	Hemmed	574	751	867	1,044	1,147	1,338	1,440	1,617	1,720	1,897	2,013	2,191	2,293
32	Hemmed	586	767	885	1,066	1,171	1,366	1,470	1,651	1,756	1,937	2,055	2,237	2,341
33	Hemmed	601	787	908	1,094	1,201	1,401	1,508	1,694	1,801	1,987	2,108	2,294	2,401
34	Hemmed	631	827	953	1,149	1,261	1,471	1,583	1,779	1,891	2,087	2,213	2,409	2,521
35	Hemmed	661	867	998	1,204	1,321	1,541	1,658	1,864	1,981	2,187	2,318	2,524	2,641
36	Hemmed	697	915	1,052	1,270	1,393	1,625	1,748	1,966	2,089	2,307	2,444	2,662	2,785

VERTICAL WRAP: For Existing Hardware

Chart pricing is per panel, for fabric only. **Maximum vane length is 114". NOTE: flair21 will add 1/4" to completely cover the vanes. WATCH OUT FOR CLEARANCE TO FLOOR/WINDOW SILL!** Sizes and series numbers beyond what is listed in the charts below are available—please submit these quote requests via fax or email.

Series	# of Vanes	5	10	15	20	25	30	35	40	45	50	55	60	65	70
07	Eurohem	103	206	288	391	472	575	657	760	863	944	1,047	1,129	1,232	1,314
08	Eurohem	113	226	313	426	512	625	712	825	938	1,024	1,137	1,224	1,337	1,424
09	Eurohem	121	242	333	454	544	665	756	877	998	1,088	1,209	1,300	1,421	1,512
10	Eurohem	129	258	353	482	576	705	800	929	1,058	1,152	1,281	1,376	1,505	1,600
11	Eurohem	137	274	373	510	608	745	844	981	1,118	1,216	1,353	1,452	1,589	1,688
12	Eurohem	145	290	393	538	640	785	888	1,033	1,178	1,280	1,425	1,528	1,673	1,776
13	Eurohem	153	306	413	566	672	825	932	1,085	1,238	1,344	1,497	1,604	1,757	1,864
14	Eurohem	161	322	433	594	704	865	976	1,137	1,298	1,408	1,569	1,680	1,841	1,952
15	Eurohem	169	338	453	622	736	905	1,020	1,189	1,358	1,472	1,641	1,756	1,925	2,040
16	Eurohem	177	354	473	650	768	945	1,064	1,241	1,418	1,536	1,713	1,832	2,009	2,128
17	Eurohem	185	370	493	678	800	985	1,108	1,293	1,478	1,600	1,785	1,908	2,093	2,216
18	Eurohem	193	386	513	706	832	1,025	1,152	1,345	1,538	1,664	1,857	1,984	2,177	2,304
19	Eurohem	201	402	533	734	864	1,065	1,196	1,397	1,598	1,728	1,929	2,060	2,261	2,392
20	Eurohem	209	418	553	762	896	1,105	1,240	1,449	1,658	1,792	2,001	2,136	2,345	2,480
21	Eurohem	217	434	573	790	928	1,145	1,284	1,501	1,718	1,856	2,073	2,212	2,429	2,568
22	Eurohem	225	450	593	818	960	1,185	1,328	1,553	1,778	1,920	2,145	2,288	2,513	2,656
23	Eurohem	233	466	613	846	992	1,225	1,372	1,605	1,838	1,984	2,217	2,364	2,597	2,744
24	Eurohem	241	482	633	874	1,024	1,265	1,416	1,657	1,898	2,048	2,289	2,440	2,681	2,832
25	Eurohem	253	506	663	916	1,072	1,325	1,482	1,735	1,988	2,144	2,397	2,554	2,807	2,964
26	Eurohem	261	522	683	944	1,104	1,365	1,526	1,787	2,048	2,208	2,469	2,630	2,891	3,052
27	Eurohem	269	538	703	972	1,136	1,405	1,570	1,839	2,108	2,272	2,541	2,706	2,975	3,140
28	Eurohem	277	554	723	1,000	1,168	1,445	1,614	1,891	2,168	2,336	2,613	2,782	3,059	3,228
29	Eurohem	285	570	743	1,028	1,200	1,485	1,658	1,943	2,228	2,400	2,685	2,858	3,143	3,316
30	Eurohem	297	594	773	1,070	1,248	1,545	1,724	2,021	2,318	2,496	2,793	2,972	3,269	3,448
31	Eurohem	303	606	788	1,091	1,272	1,575	1,757	2,060	2,363	2,544	2,847	3,029	3,332	3,514
32	Eurohem	311	622	808	1,119	1,304	1,615	1,801	2,112	2,423	2,608	2,919	3,105	3,416	3,602
33	Eurohem	321	642	833	1,154	1,344	1,665	1,856	2,177	2,498	2,688	3,009	3,200	3,521	3,712
34	Eurohem	341	682	883	1,224	1,424	1,765	1,966	2,307	2,648	2,848	3,189	3,390	3,731	3,932
35	Eurohem	361	722	933	1,294	1,504	1,865	2,076	2,437	2,798	3,008	3,369	3,580	3,941	4,152
36	Eurohem	385	770	993	1,378	1,600	1,985	2,208	2,593	2,978	3,200	3,585	3,808	4,193	4,416
37	Eurohem	421	842	1,083	1,504	1,744	2,165	2,406	2,827	3,248	3,488	3,909	4,150	4,571	4,812
38	Eurohem	501	1,002	1,283	1,784	2,064	2,565	2,846	3,347	3,848	4,128	4,629	4,910	5,411	5,692

VERTICAL WRAP COMPLETE: Inside Mount — One-way

Chart pricing includes hardware. **Maximum width 228" — Maximum length 114"**. Sizes and series numbers beyond what is listed in the charts below are available—please submit these quote requests via fax or email.

Width	24	36	48	60	72	84	96	108	120	132	144	156	168	180	192	204	216
07	261	396	510	624	727	841	976	1,090	1,204	1,318	1,421	1,535	1,670	1,784	1,898	2,012	2,147
08	276	421	540	659	767	886	1,031	1,150	1,269	1,388	1,496	1,615	1,760	1,879	1,998	2,117	2,262
09	288	441	564	687	799	922	1,075	1,198	1,321	1,444	1,556	1,679	1,832	1,955	2,078	2,201	2,354
10	300	461	588	715	831	958	1,119	1,246	1,373	1,500	1,616	1,743	1,904	2,031	2,158	2,285	2,446
11	312	481	612	743	863	994	1,163	1,294	1,425	1,556	1,676	1,807	1,976	2,107	2,238	2,369	2,538
12	324	501	636	771	895	1,030	1,207	1,342	1,477	1,612	1,736	1,871	2,048	2,183	2,318	2,453	2,630
13	336	521	660	799	927	1,066	1,251	1,390	1,529	1,668	1,796	1,935	2,120	2,259	2,398	2,537	2,722
14	348	541	684	827	959	1,102	1,295	1,438	1,581	1,724	1,856	1,999	2,192	2,335	2,478	2,621	2,814
15	360	561	708	855	991	1,138	1,339	1,486	1,633	1,780	1,916	2,063	2,264	2,411	2,558	2,705	2,906
16	372	581	732	883	1,023	1,174	1,383	1,534	1,685	1,836	1,976	2,127	2,336	2,487	2,638	2,789	2,998
17	384	601	756	911	1,055	1,210	1,427	1,582	1,737	1,892	2,036	2,191	2,408	2,563	2,718	2,873	3,090
18	396	621	780	939	1,087	1,246	1,471	1,630	1,789	1,948	2,096	2,255	2,480	2,639	2,798	2,957	3,182
19	408	641	804	967	1,119	1,282	1,515	1,678	1,841	2,004	2,156	2,319	2,552	2,715	2,878	3,041	3,274
20	420	661	828	995	1,151	1,318	1,559	1,726	1,893	2,060	2,216	2,383	2,624	2,791	2,958	3,125	3,366
21	432	681	852	1,023	1,183	1,354	1,603	1,774	1,945	2,116	2,276	2,447	2,696	2,867	3,038	3,209	3,458
22	444	701	876	1,051	1,215	1,390	1,647	1,822	1,997	2,172	2,336	2,511	2,768	2,943	3,118	3,293	3,550
23	456	721	900	1,079	1,247	1,426	1,691	1,870	2,049	2,228	2,396	2,575	2,840	3,019	3,198	3,377	3,642
24	468	741	924	1,107	1,279	1,462	1,735	1,918	2,101	2,284	2,456	2,639	2,912	3,095	3,278	3,461	3,734
25	486	771	960	1,149	1,327	1,516	1,801	1,990	2,179	2,368	2,546	2,735	3,020	3,209	3,398	3,587	3,872
26	498	791	984	1,177	1,359	1,552	1,845	2,038	2,231	2,424	2,606	2,799	3,092	3,285	3,478	3,671	3,964
27	510	811	1,008	1,205	1,391	1,588	1,889	2,086	2,283	2,480	2,666	2,863	3,164	3,361	3,558	3,755	4,056
28	522	831	1,032	1,233	1,423	1,624	1,933	2,134	2,335	2,536	2,726	2,927	3,236	3,437	3,638	3,839	4,148
29	534	851	1,056	1,261	1,455	1,660	1,977	2,182	2,387	2,592	2,786	2,991	3,308	3,513	3,718	3,923	4,240
30	552	881	1,092	1,303	1,503	1,714	2,043	2,254	2,465	2,676	2,876	3,087	3,416	3,627	3,838	4,049	4,378
31	561	896	1,110	1,324	1,527	1,741	2,076	2,290	2,504	2,718	2,921	3,135	3,470	3,684	3,898	4,112	4,447
32	573	916	1,134	1,352	1,559	1,777	2,120	2,338	2,556	2,774	2,981	3,199	3,542	3,760	3,978	4,196	4,539
33	588	941	1,164	1,387	1,599	1,822	2,175	2,398	2,621	2,844	3,056	3,279	3,632	3,855	4,078	4,301	4,654
34	618	991	1,224	1,457	1,679	1,912	2,285	2,518	2,751	2,984	3,206	3,439	3,812	4,045	4,278	4,511	4,884
35	648	1,041	1,284	1,527	1,759	2,002	2,395	2,638	2,881	3,124	3,356	3,599	3,992	4,235	4,478	4,721	5,114
36	684	1,101	1,356	1,611	1,855	2,110	2,527	2,782	3,037	3,292	3,536	3,791	4,208	4,463	4,718	4,973	5,390

VERTICAL WRAP COMPLETE: Inside Mount — Split-Draw

Chart pricing includes hardware. **Maximum width 228" — Maximum length 114"**. Sizes and series numbers beyond what is listed in the charts below are available—please submit these quote requests via fax or email.

Width	24	36	48	60	72	84	96	108	120	132	144	156	168	180	192	204	216
07	317	452	566	636	771	885	999	1,113	1,248	1,362	1,476	1,591	1,726	1,840	1,954	2,068	2,203
08	337	482	601	671	816	935	1,054	1,173	1,318	1,437	1,556	1,676	1,821	1,940	2,059	2,178	2,323
09	353	506	629	699	852	975	1,098	1,221	1,374	1,497	1,620	1,744	1,897	2,020	2,143	2,266	2,419
10	369	530	657	727	888	1,015	1,142	1,269	1,430	1,557	1,684	1,812	1,973	2,100	2,227	2,354	2,515
11	385	554	685	755	924	1,055	1,186	1,317	1,486	1,617	1,748	1,880	2,049	2,180	2,311	2,442	2,611
12	401	578	713	783	960	1,095	1,230	1,365	1,542	1,677	1,812	1,948	2,125	2,260	2,395	2,530	2,707
13	417	602	741	811	996	1,135	1,274	1,413	1,598	1,737	1,876	2,016	2,201	2,340	2,479	2,618	2,803
14	433	626	769	839	1,032	1,175	1,318	1,461	1,654	1,797	1,940	2,084	2,277	2,420	2,563	2,706	2,899
15	449	650	797	867	1,068	1,215	1,362	1,509	1,710	1,857	2,004	2,152	2,353	2,500	2,647	2,794	2,995
16	465	674	825	895	1,104	1,255	1,406	1,557	1,766	1,917	2,068	2,220	2,429	2,580	2,731	2,882	3,091
17	481	698	853	923	1,140	1,295	1,450	1,605	1,822	1,977	2,132	2,288	2,505	2,660	2,815	2,970	3,187
18	497	722	881	951	1,176	1,335	1,494	1,653	1,878	2,037	2,196	2,356	2,581	2,740	2,899	3,058	3,283
19	513	746	909	979	1,212	1,375	1,538	1,701	1,934	2,097	2,260	2,424	2,657	2,820	2,983	3,146	3,379
20	529	770	937	1,007	1,248	1,415	1,582	1,749	1,990	2,157	2,324	2,492	2,733	2,900	3,067	3,234	3,475
21	545	794	965	1,035	1,284	1,455	1,626	1,797	2,046	2,217	2,388	2,560	2,809	2,980	3,151	3,322	3,571
22	561	818	993	1,063	1,320	1,495	1,670	1,845	2,102	2,277	2,452	2,628	2,885	3,060	3,235	3,410	3,667
23	577	842	1,021	1,091	1,356	1,535	1,714	1,893	2,158	2,337	2,516	2,696	2,961	3,140	3,319	3,498	3,763
24	593	866	1,049	1,119	1,392	1,575	1,758	1,941	2,214	2,397	2,580	2,764	3,037	3,220	3,403	3,586	3,859
25	617	902	1,091	1,161	1,446	1,635	1,824	2,013	2,298	2,487	2,676	2,866	3,151	3,340	3,529	3,718	4,003
26	633	926	1,119	1,189	1,482	1,675	1,868	2,061	2,354	2,547	2,740	2,934	3,227	3,420	3,613	3,806	4,099
27	649	950	1,147	1,217	1,518	1,715	1,912	2,109	2,410	2,607	2,804	3,002	3,303	3,500	3,697	3,894	4,195
28	665	974	1,175	1,245	1,554	1,755	1,956	2,157	2,466	2,667	2,868	3,070	3,379	3,580	3,781	3,982	4,291
29	681	998	1,203	1,273	1,590	1,795	2,000	2,205	2,522	2,727	2,932	3,138	3,455	3,660	3,865	4,070	4,387
30	705	1,034	1,245	1,315	1,644	1,855	2,066	2,277	2,606	2,817	3,028	3,240	3,569	3,780	3,991	4,202	4,531
31	717	1,052	1,266	1,336	1,671	1,885	2,099	2,313	2,648	2,862	3,076	3,291	3,626	3,840	4,054	4,268	4,603
32	733	1,076	1,294	1,364	1,707	1,925	2,143	2,361	2,704	2,922	3,140	3,359	3,702	3,920	4,138	4,356	4,699
33	753	1,106	1,329	1,399	1,752	1,975	2,198	2,421	2,774	2,997	3,220	3,444	3,797	4,020	4,243	4,466	4,819
34	793	1,166	1,399	1,469	1,842	2,075	2,308	2,541	2,914	3,147	3,380	3,614	3,987	4,220	4,453	4,686	5,059
35	833	1,226	1,469	1,539	1,932	2,175	2,418	2,661	3,054	3,297	3,540	3,784	4,177	4,420	4,663	4,906	5,299
36	881	1,298	1,553	1,623	2,040	2,295	2,550	2,805	3,222	3,477	3,732	3,988	4,405	4,660	4,915	5,170	5,587

VERTICAL WRAP COMPLETE: Outside Mount — One-way

Chart pricing includes hardware. **Maximum width 228" — Maximum length 114"**. Sizes and series numbers beyond what is listed in the charts below are available—please submit these quote requests via fax or email.

Width	24	36	48	60	72	84	96	108	120	132	144	156	168	180	192	204	216
07	250	364	499	613	715	830	944	1,058	1,193	1,307	1,409	1,523	1,638	1,773	1,887	2,001	2,115
08	265	384	529	648	755	875	994	1,113	1,258	1,377	1,484	1,603	1,723	1,868	1,987	2,106	2,225
09	277	400	553	676	787	911	1,034	1,157	1,310	1,433	1,544	1,667	1,791	1,944	2,067	2,190	2,313
10	289	416	577	704	819	947	1,074	1,201	1,362	1,489	1,604	1,731	1,859	2,020	2,147	2,274	2,401
11	301	432	601	732	851	983	1,114	1,245	1,414	1,545	1,664	1,795	1,927	2,096	2,227	2,358	2,489
12	313	448	625	760	883	1,019	1,154	1,289	1,466	1,601	1,724	1,859	1,995	2,172	2,307	2,442	2,577
13	325	464	649	788	915	1,055	1,194	1,333	1,518	1,657	1,784	1,923	2,063	2,248	2,387	2,526	2,665
14	337	480	673	816	947	1,091	1,234	1,377	1,570	1,713	1,844	1,987	2,131	2,324	2,467	2,610	2,753
15	349	496	697	844	979	1,127	1,274	1,421	1,622	1,769	1,904	2,051	2,199	2,400	2,547	2,694	2,841
16	361	512	721	872	1,011	1,163	1,314	1,465	1,674	1,825	1,964	2,115	2,267	2,476	2,627	2,778	2,929
17	373	528	745	900	1,043	1,199	1,354	1,509	1,726	1,881	2,024	2,179	2,335	2,552	2,707	2,862	3,017
18	385	544	769	928	1,075	1,235	1,394	1,553	1,778	1,937	2,084	2,243	2,403	2,628	2,787	2,946	3,105
19	397	560	793	956	1,107	1,271	1,434	1,597	1,830	1,993	2,144	2,307	2,471	2,704	2,867	3,030	3,193
20	409	576	817	984	1,139	1,307	1,474	1,641	1,882	2,049	2,204	2,371	2,539	2,780	2,947	3,114	3,281
21	421	592	841	1,012	1,171	1,343	1,514	1,685	1,934	2,105	2,264	2,435	2,607	2,856	3,027	3,198	3,369
22	433	608	865	1,040	1,203	1,379	1,554	1,729	1,986	2,161	2,324	2,499	2,675	2,932	3,107	3,282	3,457
23	445	624	889	1,068	1,235	1,415	1,594	1,773	2,038	2,217	2,384	2,563	2,743	3,008	3,187	3,366	3,545
24	457	640	913	1,096	1,267	1,451	1,634	1,817	2,090	2,273	2,444	2,627	2,811	3,084	3,267	3,450	3,633
25	475	664	949	1,138	1,315	1,505	1,694	1,883	2,168	2,357	2,534	2,723	2,913	3,198	3,387	3,576	3,765
26	487	680	973	1,166	1,347	1,541	1,734	1,927	2,220	2,413	2,594	2,787	2,981	3,274	3,467	3,660	3,853
27	499	696	997	1,194	1,379	1,577	1,774	1,971	2,272	2,469	2,654	2,851	3,049	3,350	3,547	3,744	3,941
28	511	712	1,021	1,222	1,411	1,613	1,814	2,015	2,324	2,525	2,714	2,915	3,117	3,426	3,627	3,828	4,029
29	523	728	1,045	1,250	1,443	1,649	1,854	2,059	2,376	2,581	2,774	2,979	3,185	3,502	3,707	3,912	4,117
30	541	752	1,081	1,292	1,491	1,703	1,914	2,125	2,454	2,665	2,864	3,075	3,287	3,616	3,827	4,038	4,249
31	550	764	1,099	1,313	1,515	1,730	1,944	2,158	2,493	2,707	2,909	3,123	3,338	3,673	3,887	4,101	4,315
32	562	780	1,123	1,341	1,547	1,766	1,984	2,202	2,545	2,763	2,969	3,187	3,406	3,749	3,967	4,185	4,403
33	577	800	1,153	1,376	1,587	1,811	2,034	2,257	2,610	2,833	3,044	3,267	3,491	3,844	4,067	4,290	4,513
34	607	840	1,213	1,446	1,667	1,901	2,134	2,367	2,740	2,973	3,194	3,427	3,661	4,034	4,267	4,500	4,733
35	637	880	1,273	1,516	1,747	1,991	2,234	2,477	2,870	3,113	3,344	3,587	3,831	4,224	4,467	4,710	4,953
36	673	928	1,345	1,600	1,843	2,099	2,354	2,609	3,026	3,281	3,524	3,779	4,035	4,452	4,707	4,962	5,217

VERTICAL WRAP COMPLETE: Outside Mount — Split-Draw

Chart pricing includes hardware. **Maximum width 228" — Maximum length 114"**. Sizes and series numbers beyond what is listed in the charts below are available—please submit these quote requests via fax or email.

Width	24	36	48	60	72	84	96	108	120	132	144	156	168	180	192	204	216
07	294	408	522	613	727	841	976	1,090	1,204	1,318	1,453	1,568	1,682	1,796	1,910	2,045	2,159
08	314	433	552	648	767	886	1,031	1,150	1,269	1,388	1,533	1,653	1,772	1,891	2,010	2,155	2,274
09	330	453	576	676	799	922	1,075	1,198	1,321	1,444	1,597	1,721	1,844	1,967	2,090	2,243	2,366
10	346	473	600	704	831	958	1,119	1,246	1,373	1,500	1,661	1,789	1,916	2,043	2,170	2,331	2,458
11	362	493	624	732	863	994	1,163	1,294	1,425	1,556	1,725	1,857	1,988	2,119	2,250	2,419	2,550
12	378	513	648	760	895	1,030	1,207	1,342	1,477	1,612	1,789	1,925	2,060	2,195	2,330	2,507	2,642
13	394	533	672	788	927	1,066	1,251	1,390	1,529	1,668	1,853	1,993	2,132	2,271	2,410	2,595	2,734
14	410	553	696	816	959	1,102	1,295	1,438	1,581	1,724	1,917	2,061	2,204	2,347	2,490	2,683	2,826
15	426	573	720	844	991	1,138	1,339	1,486	1,633	1,780	1,981	2,129	2,276	2,423	2,570	2,771	2,918
16	442	593	744	872	1,023	1,174	1,383	1,534	1,685	1,836	2,045	2,197	2,348	2,499	2,650	2,859	3,010
17	458	613	768	900	1,055	1,210	1,427	1,582	1,737	1,892	2,109	2,265	2,420	2,575	2,730	2,947	3,102
18	474	633	792	928	1,087	1,246	1,471	1,630	1,789	1,948	2,173	2,333	2,492	2,651	2,810	3,035	3,194
19	490	653	816	956	1,119	1,282	1,515	1,678	1,841	2,004	2,237	2,401	2,564	2,727	2,890	3,123	3,286
20	506	673	840	984	1,151	1,318	1,559	1,726	1,893	2,060	2,301	2,469	2,636	2,803	2,970	3,211	3,378
21	522	693	864	1,012	1,183	1,354	1,603	1,774	1,945	2,116	2,365	2,537	2,708	2,879	3,050	3,299	3,470
22	538	713	888	1,040	1,215	1,390	1,647	1,822	1,997	2,172	2,429	2,605	2,780	2,955	3,130	3,387	3,562
23	554	733	912	1,068	1,247	1,426	1,691	1,870	2,049	2,228	2,493	2,673	2,852	3,031	3,210	3,475	3,654
24	570	753	936	1,096	1,279	1,462	1,735	1,918	2,101	2,284	2,557	2,741	2,924	3,107	3,290	3,563	3,746
25	594	783	972	1,138	1,327	1,516	1,801	1,990	2,179	2,368	2,653	2,843	3,032	3,221	3,410	3,695	3,884
26	610	803	996	1,166	1,359	1,552	1,845	2,038	2,231	2,424	2,717	2,911	3,104	3,297	3,490	3,783	3,976
27	626	823	1,020	1,194	1,391	1,588	1,889	2,086	2,283	2,480	2,781	2,979	3,176	3,373	3,570	3,871	4,068
28	642	843	1,044	1,222	1,423	1,624	1,933	2,134	2,335	2,536	2,845	3,047	3,248	3,449	3,650	3,959	4,160
29	658	863	1,068	1,250	1,455	1,660	1,977	2,182	2,387	2,592	2,909	3,115	3,320	3,525	3,730	4,047	4,252
30	682	893	1,104	1,292	1,503	1,714	2,043	2,254	2,465	2,676	3,005	3,217	3,428	3,639	3,850	4,179	4,390
31	694	908	1,122	1,313	1,527	1,741	2,076	2,290	2,504	2,718	3,053	3,268	3,482	3,696	3,910	4,245	4,459
32	710	928	1,146	1,341	1,559	1,777	2,120	2,338	2,556	2,774	3,117	3,336	3,554	3,772	3,990	4,333	4,551
33	730	953	1,176	1,376	1,599	1,822	2,175	2,398	2,621	2,844	3,197	3,421	3,644	3,867	4,090	4,443	4,666
34	770	1,003	1,236	1,446	1,679	1,912	2,285	2,518	2,751	2,984	3,357	3,591	3,824	4,057	4,290	4,663	4,896
35	810	1,053	1,296	1,516	1,759	2,002	2,395	2,638	2,881	3,124	3,517	3,761	4,004	4,247	4,490	4,883	5,126
36	858	1,113	1,368	1,600	1,855	2,110	2,527	2,782	3,037	3,292	3,709	3,965	4,220	4,475	4,730	5,147	5,402

PANEL GLIDE: Unlined

Chart pricing for fabric panels only. For complete panel glide systems, please see hardware pricing on page 31. **Maximum length 110"**. Sizes and series numbers beyond what is listed in the charts below are available—please submit these quote requests via fax or email.

Series	Panel Width															
	18	20	22	24	26	28	30	32	34	36	38	40	42	44	46	48
07	87	96	106	115	124	134	143	152	162	171	180	189	199	208	217	227
08	90	100	109	119	128	138	148	157	167	176	186	196	205	215	224	234
09	92	102	112	122	132	142	151	161	171	181	191	201	210	220	230	240
10	95	105	115	125	135	145	155	165	175	185	195	205	215	226	236	246
11	97	108	118	128	138	149	159	169	180	190	200	210	221	231	241	251
12	100	110	121	131	142	152	163	173	184	194	205	215	226	236	247	257
13	102	113	124	134	145	156	167	177	188	199	209	220	231	242	252	263
14	105	116	127	138	149	159	170	181	192	203	214	225	236	247	258	269
15	107	118	130	141	152	163	174	185	197	208	219	230	241	252	263	275
16	110	121	132	144	155	167	178	189	201	212	224	235	246	258	269	280
17	112	124	135	147	159	170	182	193	205	217	228	240	251	263	275	286
18	115	126	138	150	162	174	186	197	209	221	233	245	257	268	280	292
19	117	129	141	153	165	177	189	201	213	226	238	250	262	274	286	298
20	120	132	144	156	169	181	193	205	218	230	242	255	267	279	291	304
21	122	135	147	160	172	185	197	209	222	234	247	259	272	284	297	309
22	125	137	150	163	175	188	201	214	226	239	252	264	277	290	303	315
23	127	140	153	166	179	192	205	218	230	243	256	269	282	295	308	321
24	129	143	156	169	182	195	208	222	235	248	261	274	287	301	314	327
25	133	147	160	174	187	201	214	228	241	255	268	282	295	309	322	336
26	136	149	163	177	190	204	218	232	245	259	273	286	300	314	328	341
27	138	152	166	180	194	208	222	236	250	264	277	291	305	319	333	347
28	141	155	169	183	197	211	225	240	254	268	282	296	310	325	339	353
29	143	157	172	186	201	215	229	244	258	272	287	301	316	330	344	359
30	147	161	176	191	206	220	235	250	264	279	294	309	323	338	353	367
31	149	163	178	193	208	223	238	253	268	282	297	312	327	342	357	372
32	151	166	181	196	211	227	242	257	272	287	302	317	332	347	362	378
33	154	169	185	200	216	231	246	262	277	293	308	323	339	354	369	385
34	160	176	192	208	224	240	256	272	288	304	320	336	352	367	383	399
35	166	183	199	216	232	249	265	282	298	315	331	348	364	381	397	414
36	174	191	208	225	242	260	277	294	311	328	345	363	380	397	414	431

PANEL GLIDE: Lined (Lining 01000)

Chart pricing for fabric panels only. For complete panel glide systems, please see hardware pricing on page 31. **Maximum length 110"**. Sizes and series numbers beyond what is listed in the charts below are available—please submit these quote requests via fax or email.

Series	Panel Width															
	18	20	22	24	26	28	30	32	34	36	38	40	42	44	46	48
07	114	126	139	151	164	176	189	201	213	226	238	251	263	276	288	301
08	117	129	142	155	168	180	193	206	218	231	244	257	269	282	295	307
09	119	132	145	158	171	184	196	209	222	235	248	261	274	287	300	313
10	121	134	147	160	174	187	200	213	226	239	253	266	279	292	305	318
11	123	136	150	163	177	190	203	217	230	243	257	270	284	297	310	324
12	125	139	152	166	180	193	207	220	234	248	261	275	288	302	316	329
13	127	141	155	169	183	196	210	224	238	252	266	279	293	307	321	335
14	130	144	158	172	186	200	214	228	242	256	270	284	298	312	326	340
15	132	146	160	174	189	203	217	231	246	260	274	289	303	317	331	346
16	134	148	163	177	192	206	221	235	250	264	279	293	308	322	337	351
17	136	151	165	180	195	209	224	239	254	268	283	298	312	327	342	357
18	138	153	168	183	198	213	228	243	257	272	287	302	317	332	347	362
19	140	155	170	186	201	216	231	246	261	277	292	307	322	337	352	367
20	142	158	173	188	204	219	235	250	265	281	296	311	327	342	358	373
21	144	160	176	191	207	222	238	254	269	285	300	316	332	347	363	378
22	147	162	178	194	210	226	241	257	273	289	305	321	336	352	368	384
23	149	165	181	197	213	229	245	261	277	293	309	325	341	357	373	389
24	151	167	183	200	216	232	248	265	281	297	313	330	346	362	379	395
25	154	171	187	204	220	237	254	270	287	303	320	337	353	370	386	403
26	156	173	190	207	223	240	257	274	291	308	324	341	358	375	392	408
27	158	175	192	209	226	244	261	278	295	312	329	346	363	380	397	414
28	160	178	195	212	230	247	264	281	299	316	333	350	368	385	402	419
29	163	180	198	215	233	250	267	285	302	320	337	355	372	390	407	425
30	166	184	201	219	237	255	273	291	308	326	344	362	380	397	415	433
31	167	185	203	221	239	257	275	293	311	329	347	365	383	401	419	437
32	170	188	206	224	242	261	279	297	315	333	352	370	388	406	424	443
33	172	191	209	228	246	265	283	302	320	339	357	376	394	413	431	449
34	178	197	216	235	254	273	292	311	330	349	368	387	406	425	444	463
35	183	202	222	242	261	281	300	320	340	359	379	398	418	438	457	477
36	189	210	230	250	270	291	311	331	351	372	392	412	432	453	473	493

PANEL GLIDE: Self-Lined

Chart pricing for fabric panels only. For complete panel glide systems, please see hardware pricing on page 31. **Maximum length 110"**. Sizes and series numbers beyond what is listed in the charts below are available—please submit these quote requests via fax or email.

Series	Panel Width															
	18	20	22	24	26	28	30	32	34	36	38	40	42	44	46	48
07	110	122	134	146	158	170	182	194	206	218	230	242	254	266	278	290
08	115	128	140	153	165	178	190	203	215	228	241	253	266	278	291	303
09	119	132	145	158	171	184	197	210	223	236	249	262	275	288	301	314
10	124	137	151	164	177	191	204	218	231	245	258	271	285	298	312	325
11	128	142	156	170	183	197	211	225	239	253	267	281	294	308	322	336
12	132	146	161	175	189	204	218	232	247	261	275	290	304	318	333	347
13	136	151	166	181	196	210	225	240	255	269	284	299	314	328	343	358
14	141	156	171	186	202	217	232	247	262	278	293	308	323	338	354	369
15	145	161	176	192	208	223	239	255	270	286	302	317	333	348	364	380
16	149	165	181	198	214	230	246	262	278	294	310	326	342	359	375	391
17	154	170	187	203	220	236	253	269	286	302	319	335	352	369	385	402
18	158	175	192	209	226	243	260	277	294	311	328	345	362	379	396	413
19	162	179	197	214	232	249	267	284	301	319	336	354	371	389	406	424
20	166	184	202	220	238	256	274	291	309	327	345	363	381	399	417	434
21	171	189	207	226	244	262	280	299	317	335	354	372	390	409	427	445
22	175	194	212	231	250	269	287	306	325	344	362	381	400	419	438	456
23	179	198	218	237	256	275	294	314	333	352	371	390	410	429	448	467
24	183	203	223	242	262	282	301	321	341	360	380	400	419	439	459	478
25	190	210	230	251	271	291	312	332	352	373	393	413	434	454	474	495
26	194	215	236	256	277	298	319	339	360	381	402	422	443	464	485	506
27	198	220	241	262	283	304	326	347	368	389	410	432	453	474	495	516
28	203	224	246	268	289	311	332	354	376	397	419	441	462	484	506	527
29	207	229	251	273	295	317	339	362	384	406	428	450	472	494	516	538
30	213	236	259	282	304	327	350	373	395	418	441	464	486	509	532	555
31	216	240	263	286	309	332	355	378	401	424	447	471	494	517	540	563
32	221	244	268	291	315	338	362	386	409	433	456	480	503	527	550	574
33	226	250	274	298	322	347	371	395	419	443	467	491	515	539	563	588
34	237	262	287	312	338	363	388	413	438	464	489	514	539	564	590	615
35	247	274	300	326	353	379	405	432	458	484	511	537	563	590	616	642
36	260	288	315	343	371	398	426	454	481	509	537	564	592	620	647	675

FABRIC SHADES: Austrian — Unlined

Chart pricing includes board mount or headrail mount. Sizes and series numbers beyond what is listed in the charts below are available—please submit these quote requests via fax or email. **NOTE: For headrail mount:** manual—maximum width 103"; motorized—maximum width 69". For larger widths, please order board mount shades.

AUSTRIAN SHADE

Series 07

Length Up To	Overall Finished Width							
	24	36	48	60	72	84	96	108
36	300	429	483	587	713	818	944	1,048
48	377	438	583	708	854	978	1,145	1,270
60	374	518	684	828	1,015	1,160	1,325	1,470
72	414	578	785	949	1,156	1,320	1,527	1,691
84	474	659	885	1,070	1,296	1,481	1,707	1,891
96	514	719	986	1,190	1,437	1,641	1,908	2,113
108	575	799	1,087	1,311	1,577	1,801	2,089	2,313

Series 08

Length Up To	Overall Finished Width							
	24	36	48	60	72	84	96	108
36	310	439	498	602	733	838	969	1,073
48	392	453	603	728	879	1,003	1,180	1,305
60	394	538	709	853	1,050	1,195	1,365	1,510
72	434	598	815	979	1,196	1,360	1,577	1,741
84	499	684	920	1,105	1,341	1,526	1,762	1,946
96	539	744	1,026	1,230	1,487	1,691	1,973	2,178
108	749	1,045	1,419	1,715	2,089	2,385	2,759	3,055

Series 09

Length Up To	Overall Finished Width							
	24	36	48	60	72	84	96	108
36	318	447	510	614	749	854	989	1,093
48	404	465	619	744	899	1,023	1,208	1,333
60	410	554	729	873	1,078	1,223	1,397	1,542
72	450	614	839	1,003	1,228	1,392	1,617	1,781
84	519	704	948	1,133	1,377	1,562	1,806	1,990
96	559	764	1,058	1,262	1,527	1,731	2,025	2,230
108	629	853	1,168	1,392	1,676	1,900	2,215	2,439

Series 10

Length Up To	Overall Finished Width							
	24	36	48	60	72	84	96	108
36	326	455	522	626	765	870	1,009	1,113
48	416	477	635	760	919	1,043	1,236	1,361
60	426	570	749	893	1,106	1,251	1,429	1,574
72	466	630	863	1,027	1,260	1,424	1,657	1,821
84	539	724	976	1,161	1,413	1,598	1,850	2,034
96	579	784	1,090	1,294	1,567	1,771	2,077	2,282
108	797	1,093	1,491	1,787	2,185	2,481	2,879	3,175

Series 11

Length Up To	Overall Finished Width							
	24	36	48	60	72	84	96	108
36	334	463	534	638	781	886	1,029	1,133
48	428	489	651	776	939	1,063	1,264	1,389
60	442	586	769	913	1,134	1,279	1,461	1,606
72	482	646	887	1,051	1,292	1,456	1,697	1,861
84	559	744	1,004	1,189	1,449	1,634	1,894	2,078
96	599	804	1,122	1,326	1,607	1,811	2,129	2,334
108	677	901	1,240	1,464	1,764	1,988	2,327	2,551

Series 12

Length Up To	Overall Finished Width							
	24	36	48	60	72	84	96	108
36	342	471	546	650	797	902	1,049	1,153
48	440	501	667	792	959	1,083	1,292	1,417
60	458	602	789	933	1,162	1,307	1,493	1,638
72	498	662	911	1,075	1,324	1,488	1,737	1,901
84	579	764	1,032	1,217	1,485	1,670	1,938	2,122
96	619	824	1,154	1,358	1,647	1,851	2,181	2,386
108	845	1,141	1,563	1,859	2,281	2,577	2,999	3,295

Series 13

Length Up To	Overall Finished Width							
	24	36	48	60	72	84	96	108
36	350	479	558	662	813	918	1,069	1,173
48	452	513	683	808	979	1,103	1,320	1,445
60	474	618	809	953	1,190	1,335	1,525	1,670
72	514	678	935	1,099	1,356	1,520	1,777	1,941
84	599	784	1,060	1,245	1,521	1,706	1,982	2,166
96	639	844	1,186	1,390	1,687	1,891	2,233	2,438
108	725	949	1,312	1,536	1,852	2,076	2,439	2,663

Series 14

Length Up To	Overall Finished Width							
	24	36	48	60	72	84	96	108
36	358	487	570	674	829	934	1,089	1,193
48	464	525	699	824	999	1,123	1,348	1,473
60	490	634	829	973	1,218	1,363	1,557	1,702
72	530	694	959	1,123	1,388	1,552	1,817	1,981
84	619	804	1,088	1,273	1,557	1,742	2,026	2,210
96	659	864	1,218	1,422	1,727	1,931	2,285	2,490
108	893	1,189	1,635	1,931	2,377	2,673	3,119	3,415

Series 15

Length Up To	Overall Finished Width							
	24	36	48	60	72	84	96	108
36	366	495	582	686	845	950	1,109	1,213
48	476	537	715	840	1,019	1,143	1,376	1,501
60	506	650	849	993	1,246	1,391	1,589	1,734
72	546	710	983	1,147	1,420	1,584	1,857	2,021
84	639	824	1,116	1,301	1,593	1,778	2,070	2,254
96	679	884	1,250	1,454	1,767	1,971	2,337	2,542
108	773	997	1,384	1,608	1,940	2,164	2,551	2,775

Series 16

Length Up To	Overall Finished Width							
	24	36	48	60	72	84	96	108
36	374	503	594	698	861	966	1,129	1,233
48	488	549	731	856	1,039	1,163	1,404	1,529
60	522	666	869	1,013	1,274	1,419	1,621	1,766
72	562	726	1,007	1,171	1,452	1,616	1,897	2,061
84	659	844	1,144	1,329	1,629	1,814	2,114	2,298
96	699	904	1,282	1,486	1,807	2,011	2,389	2,594
108	941	1,237	1,707	2,003	2,473	2,769	3,239	3,535

Series 17

Length Up To	Overall Finished Width							
	24	36	48	60	72	84	96	108
36	382	511	606	710	877	982	1,149	1,253
48	500	561	747	872	1,059	1,183	1,432	1,557
60	538	682	889	1,033	1,302	1,447	1,653	1,798
72	578	742	1,031	1,195	1,484	1,648	1,937	2,101
84	679	864	1,172	1,357	1,665	1,850	2,158	2,342
96	719	924	1,314	1,518	1,847	2,051	2,441	2,646
108	821	1,045	1,456	1,680	2,028	2,252	2,663	2,887

Series 18

Length Up To	Overall Finished Width							
	24	36	48	60	72	84	96	108
36	390	519	618	722	893	998	1,169	1,273
48	512	573	763	888	1,079	1,203	1,460	1,585
60	554	698	909	1,053	1,330	1,475	1,685	1,830
72	594	758	1,055	1,219	1,516	1,680	1,977	2,141
84	699	884	1,200	1,385	1,701	1,886	2,202	2,386
96	739	944	1,346	1,550	1,887	2,091	2,493	2,698
108	989	1,285	1,779	2,075	2,569	2,865	3,359	3,655

NOTE: For Austrian shades, please specify the length option: to the bottom of the scallop OR to the bottom of the weight bar

FABRIC SHADES: Austrian — Unlined

Chart pricing includes board mount or headrail mount. Sizes and series numbers beyond what is listed in the charts below are available—please submit these quote requests via fax or email. **NOTE: For headrail mount:** manual—maximum width 103"; motorized—maximum width 69". For larger widths, please order board mount shades.

AUSTRIAN SHADE

		Series 19							
		Overall Finished Width							
Length Up To		24	36	48	60	72	84	96	108
36		398	527	630	734	909	1,014	1,189	1,293
48		524	585	779	904	1,099	1,223	1,488	1,613
60		570	714	929	1,073	1,358	1,503	1,717	1,862
72		610	774	1,079	1,243	1,548	1,712	2,017	2,181
84		719	904	1,228	1,413	1,737	1,922	2,246	2,430
96		759	964	1,378	1,582	1,927	2,131	2,545	2,750
108		869	1,093	1,528	1,752	2,116	2,340	2,775	2,999

		Series 20							
		Overall Finished Width							
Length Up To		24	36	48	60	72	84	96	108
36		406	535	642	746	925	1,030	1,209	1,313
48		536	597	795	920	1,119	1,243	1,516	1,641
60		586	730	949	1,093	1,386	1,531	1,749	1,894
72		626	790	1,103	1,267	1,580	1,744	2,057	2,221
84		739	924	1,256	1,441	1,773	1,958	2,290	2,474
96		779	984	1,410	1,614	1,967	2,171	2,597	2,802
108		1,037	1,333	1,851	2,147	2,665	2,961	3,479	3,775

		Series 21							
		Overall Finished Width							
Length Up To		24	36	48	60	72	84	96	108
36		414	543	654	758	941	1,046	1,229	1,333
48		548	609	811	936	1,139	1,263	1,544	1,669
60		602	746	969	1,113	1,414	1,559	1,781	1,926
72		642	806	1,127	1,291	1,612	1,776	2,097	2,261
84		759	944	1,284	1,469	1,809	1,994	2,334	2,518
96		799	1,004	1,442	1,646	2,007	2,211	2,649	2,854
108		917	1,141	1,600	1,824	2,204	2,428	2,887	3,111

		Series 22							
		Overall Finished Width							
Length Up To		24	36	48	60	72	84	96	108
36		422	551	666	770	957	1,062	1,249	1,353
48		560	621	827	952	1,159	1,283	1,572	1,697
60		618	762	989	1,133	1,442	1,587	1,813	1,958
72		658	822	1,151	1,315	1,644	1,808	2,137	2,301
84		779	964	1,312	1,497	1,845	2,030	2,378	2,562
96		819	1,024	1,474	1,678	2,047	2,251	2,701	2,906
108		1,085	1,381	1,923	2,219	2,761	3,057	3,599	3,895

		Series 23							
		Overall Finished Width							
Length Up To		24	36	48	60	72	84	96	108
36		430	559	678	782	973	1,078	1,269	1,373
48		572	633	843	968	1,179	1,303	1,600	1,725
60		634	778	1,009	1,153	1,470	1,615	1,845	1,990
72		674	838	1,175	1,339	1,676	1,840	2,177	2,341
84		799	984	1,340	1,525	1,881	2,066	2,422	2,606
96		839	1,044	1,506	1,710	2,087	2,291	2,753	2,958
108		965	1,189	1,672	1,896	2,292	2,516	2,999	3,223

		Series 24							
		Overall Finished Width							
Length Up To		24	36	48	60	72	84	96	108
36		438	567	690	794	989	1,094	1,289	1,393
48		584	645	859	984	1,199	1,323	1,628	1,753
60		650	794	1,029	1,173	1,498	1,643	1,877	2,022
72		690	854	1,199	1,363	1,708	1,872	2,217	2,381
84		819	1,004	1,368	1,553	1,917	2,102	2,466	2,650
96		859	1,064	1,538	1,742	2,127	2,331	2,805	3,010
108		1,133	1,429	1,995	2,291	2,857	3,153	3,719	4,015

		Series 25							
		Overall Finished Width							
Length Up To		24	36	48	60	72	84	96	108
36		450	579	708	812	1,013	1,118	1,319	1,423
48		602	663	883	1,008	1,229	1,353	1,670	1,795
60		674	818	1,059	1,203	1,540	1,685	1,925	2,070
72		714	878	1,235	1,399	1,756	1,920	2,277	2,441
84		849	1,034	1,410	1,595	1,971	2,156	2,532	2,716
96		889	1,094	1,586	1,790	2,187	2,391	2,883	3,088
108		1,025	1,249	1,762	1,986	2,402	2,626	3,139	3,363

		Series 26							
		Overall Finished Width							
Length Up To		24	36	48	60	72	84	96	108
36		458	587	720	824	1,029	1,134	1,339	1,443
48		614	675	899	1,024	1,249	1,373	1,698	1,823
60		690	834	1,079	1,223	1,568	1,713	1,957	2,102
72		730	894	1,259	1,423	1,788	1,952	2,317	2,481
84		869	1,054	1,438	1,623	2,007	2,192	2,576	2,760
96		909	1,114	1,618	1,822	2,227	2,431	2,935	3,140
108		1,193	1,489	2,085	2,381	2,977	3,273	3,869	4,165

		Series 27							
		Overall Finished Width							
Length Up To		24	36	48	60	72	84	96	108
36		466	595	732	836	1,045	1,150	1,359	1,463
48		626	687	915	1,040	1,269	1,393	1,726	1,851
60		706	850	1,099	1,243	1,596	1,741	1,989	2,134
72		746	910	1,283	1,447	1,820	1,984	2,357	2,521
84		889	1,074	1,466	1,651	2,043	2,228	2,620	2,804
96		929	1,134	1,650	1,854	2,267	2,471	2,987	3,192
108		1,073	1,297	1,834	2,058	2,490	2,714	3,251	3,475

		Series 28							
		Overall Finished Width							
Length Up To		24	36	48	60	72	84	96	108
36		474	603	744	848	1,061	1,166	1,379	1,483
48		638	699	931	1,056	1,289	1,413	1,754	1,879
60		722	866	1,119	1,263	1,624	1,769	2,021	2,166
72		762	926	1,307	1,471	1,852	2,016	2,397	2,561
84		909	1,094	1,494	1,679	2,079	2,264	2,664	2,848
96		949	1,154	1,682	1,886	2,307	2,511	3,039	3,244
108		1,241	1,537	2,157	2,453	3,073	3,369	3,989	4,285

		Series 29							
		Overall Finished Width							
Length Up To		24	36	48	60	72	84	96	108
36		482	611	756	860	1,077	1,182	1,399	1,503
48		650	711	947	1,072	1,309	1,433	1,782	1,907
60		738	882	1,139	1,283	1,652	1,797	2,053	2,198
72		778	942	1,331	1,495	1,884	2,048	2,437	2,601
84		929	1,114	1,522	1,707	2,115	2,300	2,708	2,892
96		969	1,174	1,714	1,918	2,347	2,551	3,091	3,296
108		1,121	1,345	1,906	2,130	2,578	2,802	3,363	3,587

		Series 30							
		Overall Finished Width							
Length Up To		24	36	48	60	72	84	96	108
36		494	623	774	878	1,101	1,206	1,429	1,533
48		668	729	971	1,096	1,339	1,463	1,824	1,949
60		762	906	1,169	1,313	1,694	1,839	2,101	2,246
72		802	966	1,367	1,531	1,932	2,096	2,497	2,661
84		959	1,144	1,564	1,749	2,169	2,354	2,774	2,958
96		999	1,204	1,762	1,966	2,407	2,611	3,169	3,374
108		1,301	1,597	2,247	2,543	3,193	3,489	4,139	4,435

NOTE: For Austrian shades, please specify the length option: to the bottom of the scallop OR to the bottom of the weight bar

FABRIC SHADES: Austrian — Unlined

Chart pricing includes board mount or headrail mount. Sizes and series numbers beyond what is listed in the charts below are available—please submit these quote requests via fax or email. **NOTE: For headrail mount:** manual—maximum width 103"; motorized—maximum width 69". For larger widths, please order board mount shades.

AUSTRIAN SHADE

		Series 31							
		Overall Finished Width							
Length	Up To	24	36	48	60	72	84	96	108
36		500	629	783	887	1,113	1,218	1,444	1,548
48		677	738	983	1,108	1,354	1,478	1,845	1,970
60		774	918	1,184	1,328	1,715	1,860	2,125	2,270
72		814	978	1,385	1,549	1,956	2,120	2,527	2,691
84		974	1,159	1,585	1,770	2,196	2,381	2,807	2,991
96		1,014	1,219	1,786	1,990	2,437	2,641	3,208	3,413
108		1,175	1,399	1,987	2,211	2,677	2,901	3,489	3,713

		Series 32							
		Overall Finished Width							
Length	Up To	24	36	48	60	72	84	96	108
36		508	637	795	899	1,129	1,234	1,464	1,568
48		689	750	999	1,124	1,374	1,498	1,873	1,998
60		790	934	1,204	1,348	1,743	1,888	2,157	2,302
72		830	994	1,409	1,573	1,988	2,152	2,567	2,731
84		994	1,179	1,613	1,798	2,232	2,417	2,851	3,035
96		1,034	1,239	1,818	2,022	2,477	2,681	3,260	3,465
108		1,343	1,639	2,310	2,606	3,277	3,573	4,244	4,540

		Series 33							
		Overall Finished Width							
Length	Up To	24	36	48	60	72	84	96	108
36		518	647	810	914	1,149	1,254	1,489	1,593
48		704	765	1,019	1,144	1,399	1,523	1,908	2,033
60		810	954	1,229	1,373	1,778	1,923	2,197	2,342
72		850	1,014	1,439	1,603	2,028	2,192	2,617	2,781
84		1,019	1,204	1,648	1,833	2,277	2,462	2,906	3,090
96		1,059	1,264	1,858	2,062	2,527	2,731	3,325	3,530
108		1,229	1,453	2,068	2,292	2,776	3,000	3,615	3,839

		Series 34							
		Overall Finished Width							
Length	Up To	24	36	48	60	72	84	96	108
36		538	667	840	944	1,189	1,294	1,539	1,643
48		734	795	1,059	1,184	1,449	1,573	1,978	2,103
60		850	994	1,279	1,423	1,848	1,993	2,277	2,422
72		890	1,054	1,499	1,663	2,108	2,272	2,717	2,881
84		1,069	1,254	1,718	1,903	2,367	2,552	3,016	3,200
96		1,109	1,314	1,938	2,142	2,627	2,831	3,455	3,660
108		1,433	1,729	2,445	2,741	3,457	3,753	4,469	4,765

		Series 35							
		Overall Finished Width							
Length	Up To	24	36	48	60	72	84	96	108
36		558	687	870	974	1,229	1,334	1,589	1,693
48		764	825	1,099	1,224	1,499	1,623	2,048	2,173
60		890	1,034	1,329	1,473	1,918	2,063	2,357	2,502
72		930	1,094	1,559	1,723	2,188	2,352	2,817	2,981
84		1,119	1,304	1,788	1,973	2,457	2,642	3,126	3,310
96		1,159	1,364	2,018	2,222	2,727	2,931	3,585	3,790
108		1,349	1,573	2,248	2,472	2,996	3,220	3,895	4,119

		Series 36							
		Overall Finished Width							
Length	Up To	24	36	48	60	72	84	96	108
36		582	711	906	1,010	1,277	1,382	1,649	1,753
48		800	861	1,147	1,272	1,559	1,683	2,132	2,257
60		938	1,082	1,389	1,533	2,002	2,147	2,453	2,598
72		978	1,142	1,631	1,795	2,284	2,448	2,937	3,101
84		1,179	1,364	1,872	2,057	2,565	2,750	3,258	3,442
96		1,219	1,424	2,114	2,318	2,847	3,051	3,741	3,946
108		1,565	1,861	2,643	2,939	3,721	4,017	4,799	5,095

		Series 37							
		Overall Finished Width							
Length	Up To	24	36	48	60	72	84	96	108
36		618	747	960	1,064	1,349	1,454	1,739	1,843
48		854	915	1,219	1,344	1,649	1,773	2,258	2,383
60		1,010	1,154	1,479	1,623	2,128	2,273	2,597	2,742
72		1,050	1,214	1,739	1,903	2,428	2,592	3,117	3,281
84		1,269	1,454	1,998	2,183	2,727	2,912	3,456	3,640
96		1,309	1,514	2,258	2,462	3,027	3,231	3,975	4,180
108		1,529	1,753	2,518	2,742	3,326	3,550	4,315	4,539

		Series 38							
		Overall Finished Width							
Length	Up To	24	36	48	60	72	84	96	108
36		698	827	1,080	1,184	1,509	1,614	1,939	2,043
48		974	1,035	1,379	1,504	1,849	1,973	2,538	2,663
60		1,170	1,314	1,679	1,823	2,408	2,553	2,917	3,062
72		1,210	1,374	1,979	2,143	2,748	2,912	3,517	3,681
84		1,469	1,654	2,278	2,463	3,087	3,272	3,896	4,080
96		1,509	1,714	2,578	2,782	3,427	3,631	4,495	4,700
108		1,913	2,209	3,165	3,461	4,417	4,713	5,669	5,965

NOTE: For Austrian shades, please specify the length option: to the bottom of the scallop OR to the bottom of the weight bar

FABRIC SHADES: Roman — Unlined

Chart pricing includes board mount or headrail mount. Sizes and series numbers beyond what is listed in the charts below are available—please submit these quote requests via fax or email. **NOTE: For headrail mount:** manual—maximum width 141"; motorized—maximum width 111". For larger widths, please order board mount shades.

FLAT ROMAN SHADE

Series 07

Length Up To	Overall Finished Width							
	24	36	48	60	72	84	96	108
36	190	247	311	383	477	549	621	694
48	217	266	347	429	531	613	694	776
60	203	314	405	495	586	677	767	879
72	221	342	441	541	662	762	861	961
84	239	369	478	587	717	825	934	1,064
96	257	396	514	632	771	889	1,007	1,146
108	276	424	551	678	826	953	1,080	1,228

Series 08

Length Up To	Overall Finished Width							
	24	36	48	60	72	84	96	108
36	195	280	316	388	487	559	631	704
48	222	271	352	434	541	623	704	786
60	208	324	415	505	596	687	777	894
72	226	352	451	551	677	777	876	976
84	244	379	488	597	732	840	949	1,084
96	262	406	524	642	786	904	1,022	1,166
108	281	434	561	688	841	968	1,095	1,248

Series 09

Length Up To	Overall Finished Width							
	24	36	48	60	72	84	96	108
36	199	255	320	392	495	567	639	712
48	226	275	356	438	549	631	712	794
60	212	332	423	513	604	695	785	906
72	230	360	459	559	689	789	888	988
84	248	387	496	605	744	852	961	1,100
96	266	414	532	650	798	916	1,034	1,182
108	285	442	569	696	853	980	1,107	1,264

Series 10

Length Up To	Overall Finished Width							
	24	36	48	60	72	84	96	108
36	203	259	324	396	503	575	647	720
48	230	279	360	442	557	639	720	802
60	216	340	431	521	612	703	793	918
72	234	368	467	567	701	801	900	1,000
84	252	395	504	613	756	864	973	1,116
96	270	422	540	658	810	928	1,046	1,198
108	289	450	577	704	865	992	1,119	1,280

Series 11

Length Up To	Overall Finished Width							
	24	36	48	60	72	84	96	108
36	207	263	328	400	511	583	655	728
48	234	283	364	446	565	647	728	810
60	220	348	439	529	620	711	801	930
72	238	376	475	575	713	813	912	1,012
84	256	403	512	621	768	876	985	1,132
96	274	430	548	666	822	940	1,058	1,214
108	293	458	585	712	877	1,004	1,131	1,296

Series 12

Length Up To	Overall Finished Width							
	24	36	48	60	72	84	96	108
36	211	266	332	404	519	591	663	736
48	238	287	368	450	573	655	736	818
60	224	356	447	537	628	719	809	942
72	242	384	483	583	725	825	924	1,024
84	260	411	520	629	780	888	997	1,148
96	278	438	556	674	834	952	1,070	1,230
108	297	466	593	720	889	1,016	1,143	1,312

Series 13

Length Up To	Overall Finished Width							
	24	36	48	60	72	84	96	108
36	215	270	336	408	527	599	671	744
48	242	291	372	454	581	663	744	826
60	228	364	455	545	636	727	817	954
72	246	392	491	591	737	837	936	1,036
84	264	419	528	637	792	900	1,009	1,164
96	282	446	564	682	846	964	1,082	1,246
108	301	474	601	728	901	1,028	1,155	1,328

Series 14

Length Up To	Overall Finished Width							
	24	36	48	60	72	84	96	108
36	219	273	340	412	535	607	679	752
48	246	295	376	458	589	671	752	834
60	232	372	463	553	644	735	825	966
72	250	400	499	599	749	849	948	1,048
84	268	427	536	645	804	912	1,021	1,180
96	286	454	572	690	858	976	1,094	1,262
108	305	482	609	736	913	1,040	1,167	1,344

Series 15

Length Up To	Overall Finished Width							
	24	36	48	60	72	84	96	108
36	223	277	344	416	543	615	687	760
48	250	299	380	462	597	679	760	842
60	236	380	471	561	652	743	833	978
72	254	408	507	607	761	861	960	1,060
84	272	435	544	653	816	924	1,033	1,196
96	290	462	580	698	870	988	1,106	1,278
108	309	490	617	744	925	1,052	1,179	1,360

Series 16

Length Up To	Overall Finished Width							
	24	36	48	60	72	84	96	108
36	227	281	348	420	551	623	695	768
48	254	303	384	466	605	687	768	850
60	240	388	479	569	660	751	841	990
72	258	416	515	615	773	873	972	1,072
84	276	443	552	661	828	936	1,045	1,212
96	294	470	588	706	882	1,000	1,118	1,294
108	313	498	625	752	937	1,064	1,191	1,376

Series 17

Length Up To	Overall Finished Width							
	24	36	48	60	72	84	96	108
36	231	284	352	424	559	631	703	776
48	258	307	388	470	613	695	776	858
60	244	396	487	577	668	759	849	1,002
72	262	424	523	623	785	885	984	1,084
84	280	451	560	669	840	948	1,057	1,228
96	298	478	596	714	894	1,012	1,130	1,310
108	317	506	633	760	949	1,076	1,203	1,392

Series 18

Length Up To	Overall Finished Width							
	24	36	48	60	72	84	96	108
36	235	288	356	428	567	639	711	784
48	262	311	392	474	621	703	784	866
60	248	404	495	585	676	767	857	1,014
72	266	432	531	631	797	897	996	1,096
84	284	459	568	677	852	960	1,069	1,244
96	302	486	604	722	906	1,024	1,142	1,326
108	321	514	641	768	961	1,088	1,215	1,408

FABRIC SHADES: Roman — Unlined

Chart pricing includes board mount or headrail mount. Sizes and series numbers beyond what is listed in the charts below are available—please submit these quote requests via fax or email. **NOTE: For headrail mount:** manual—maximum width 141"; motorized—maximum width 111". For larger widths, please order board mount shades.

FLAT ROMAN SHADE

		Series 19							
		Overall Finished Width							
Length Up To		24	36	48	60	72	84	96	108
36		239	291	360	432	575	647	719	792
48		266	315	396	478	629	711	792	874
60		252	412	503	593	684	775	865	1,026
72		270	440	539	639	809	909	1,008	1,108
84		288	467	576	685	864	972	1,081	1,260
96		306	494	612	730	918	1,036	1,154	1,342
108		325	522	649	776	973	1,100	1,227	1,424

		Series 20							
		Overall Finished Width							
Length Up To		24	36	48	60	72	84	96	108
36		243	295	364	436	583	655	727	800
48		270	319	400	482	637	719	800	882
60		256	420	511	601	692	783	873	1,038
72		274	448	547	647	821	921	1,020	1,120
84		292	475	584	693	876	984	1,093	1,276
96		310	502	620	738	930	1,048	1,166	1,358
108		329	530	657	784	985	1,112	1,239	1,440

		Series 21							
		Overall Finished Width							
Length Up To		24	36	48	60	72	84	96	108
36		247	299	368	440	591	663	735	808
48		274	323	404	486	645	727	808	890
60		260	428	519	609	700	791	881	1,050
72		278	456	555	655	833	933	1,032	1,132
84		296	483	592	701	888	996	1,105	1,292
96		314	510	628	746	942	1,060	1,178	1,374
108		333	538	665	792	997	1,124	1,251	1,456

		Series 22							
		Overall Finished Width							
Length Up To		24	36	48	60	72	84	96	108
36		251	302	372	444	599	671	743	816
48		278	327	408	490	653	735	816	898
60		264	436	527	617	708	799	889	1,062
72		282	464	563	663	845	945	1,044	1,144
84		300	491	600	709	900	1,008	1,117	1,308
96		318	518	636	754	954	1,072	1,190	1,390
108		337	546	673	800	1,009	1,136	1,263	1,472

		Series 23							
		Overall Finished Width							
Length Up To		24	36	48	60	72	84	96	108
36		255	306	376	448	607	679	751	824
48		282	331	412	494	661	743	824	906
60		268	444	535	625	716	807	897	1,074
72		286	472	571	671	857	957	1,056	1,156
84		304	499	608	717	912	1,020	1,129	1,324
96		322	526	644	762	966	1,084	1,202	1,406
108		341	554	681	808	1,021	1,148	1,275	1,488

		Series 24							
		Overall Finished Width							
Length Up To		24	36	48	60	72	84	96	108
36		259	309	380	452	615	687	759	832
48		286	335	416	498	669	751	832	914
60		272	452	543	633	724	815	905	1,086
72		290	480	579	679	869	969	1,068	1,168
84		308	507	616	725	924	1,032	1,141	1,340
96		326	534	652	770	978	1,096	1,214	1,422
108		345	562	689	816	1,033	1,160	1,287	1,504

		Series 25							
		Overall Finished Width							
Length Up To		24	36	48	60	72	84	96	108
36		265	315	386	458	627	699	771	844
48		292	341	422	504	681	763	844	926
60		278	464	555	645	736	827	917	1,104
72		296	492	591	691	887	987	1,086	1,186
84		314	519	628	737	942	1,050	1,159	1,364
96		332	546	664	782	996	1,114	1,232	1,446
108		351	574	701	828	1,051	1,178	1,305	1,528

		Series 26							
		Overall Finished Width							
Length Up To		24	36	48	60	72	84	96	108
36		269	318	390	462	635	707	779	852
48		296	345	426	508	689	771	852	934
60		282	472	563	653	744	835	925	1,116
72		300	500	599	699	899	999	1,098	1,198
84		318	527	636	745	954	1,062	1,171	1,380
96		336	554	672	790	1,008	1,126	1,244	1,462
108		355	582	709	836	1,063	1,190	1,317	1,544

		Series 27							
		Overall Finished Width							
Length Up To		24	36	48	60	72	84	96	108
36		273	322	394	466	643	715	787	860
48		300	349	430	512	697	779	860	942
60		286	480	571	661	752	843	933	1,128
72		304	508	607	707	911	1,011	1,110	1,210
84		322	535	644	753	966	1,074	1,183	1,396
96		340	562	680	798	1,020	1,138	1,256	1,478
108		359	590	717	844	1,075	1,202	1,329	1,560

		Series 28							
		Overall Finished Width							
Length Up To		24	36	48	60	72	84	96	108
36		277	326	398	470	651	723	795	868
48		304	353	434	516	705	787	868	950
60		290	488	579	669	760	851	941	1,140
72		308	516	615	715	923	1,023	1,122	1,222
84		326	543	652	761	978	1,086	1,195	1,412
96		344	570	688	806	1,032	1,150	1,268	1,494
108		363	598	725	852	1,087	1,214	1,341	1,576

		Series 29							
		Overall Finished Width							
Length Up To		24	36	48	60	72	84	96	108
36		281	329	402	474	659	731	803	876
48		308	357	438	520	713	795	876	958
60		294	496	587	677	768	859	949	1,152
72		312	524	623	723	935	1,035	1,134	1,234
84		330	551	660	769	990	1,098	1,207	1,428
96		348	578	696	814	1,044	1,162	1,280	1,510
108		367	606	733	860	1,099	1,226	1,353	1,592

		Series 30							
		Overall Finished Width							
Length Up To		24	36	48	60	72	84	96	108
36		287	335	408	480	671	743	815	888
48		314	363	444	526	725	807	888	970
60		300	508	599	689	780	871	961	1,170
72		318	536	635	735	953	1,053	1,152	1,252
84		336	563	672	781	1,008	1,116	1,225	1,452
96		354	590	708	826	1,062	1,180	1,298	1,534
108		373	618	745	872	1,117	1,244	1,371	1,616

FABRIC SHADES: Roman — Unlined

Chart pricing includes board mount or headrail mount. Sizes and series numbers beyond what is listed in the charts below are available—please submit these quote requests via fax or email. **NOTE: For headrail mount:** manual—maximum width 141"; motorized—maximum width 111". For larger widths, please order board mount shades.

FLAT ROMAN SHADE

		Series 31							
		Overall Finished Width							
Length	Up To	24	36	48	60	72	84	96	108
36		290	337	411	483	677	749	821	894
48		317	366	447	529	731	813	894	976
60		303	514	605	695	786	877	967	1,179
72		321	542	641	741	962	1,062	1,161	1,261
84		339	569	678	787	1,017	1,125	1,234	1,464
96		357	596	714	832	1,071	1,189	1,307	1,546
108		376	624	751	878	1,126	1,253	1,380	1,628

		Series 32							
		Overall Finished Width							
Length	Up To	24	36	48	60	72	84	96	108
36		294	341	415	487	685	757	829	902
48		321	370	451	533	739	821	902	984
60		307	522	613	703	794	885	975	1,191
72		325	550	649	749	974	1,074	1,173	1,273
84		343	577	686	795	1,029	1,137	1,246	1,480
96		361	604	722	840	1,083	1,201	1,319	1,562
108		380	632	759	886	1,138	1,265	1,392	1,644

		Series 33							
		Overall Finished Width							
Length	Up To	24	36	48	60	72	84	96	108
36		299	365	420	492	695	767	839	912
48		326	375	456	538	749	831	912	994
60		312	532	623	713	804	895	985	1,206
72		330	560	659	759	989	1,089	1,188	1,288
84		348	587	696	805	1,044	1,152	1,261	1,500
96		366	614	732	850	1,098	1,216	1,334	1,582
108		385	642	769	896	1,153	1,280	1,407	1,664

		Series 34							
		Overall Finished Width							
Length	Up To	24	36	48	60	72	84	96	108
36		309	374	430	502	715	787	859	932
48		336	385	466	548	769	851	932	1,014
60		322	552	643	733	824	915	1,005	1,236
72		340	580	679	779	1,019	1,119	1,218	1,318
84		358	607	716	825	1,074	1,182	1,291	1,540
96		376	634	752	870	1,128	1,246	1,364	1,622
108		395	662	789	916	1,183	1,310	1,437	1,704

		Series 35							
		Overall Finished Width							
Length	Up To	24	36	48	60	72	84	96	108
36		319	384	440	512	735	807	879	952
48		346	395	476	558	789	871	952	1,034
60		332	572	663	753	844	935	1,025	1,266
72		350	600	699	799	1,049	1,149	1,248	1,348
84		368	627	736	845	1,104	1,212	1,321	1,580
96		386	654	772	890	1,158	1,276	1,394	1,662
108		405	682	809	936	1,213	1,340	1,467	1,744

		Series 36							
		Overall Finished Width							
Length	Up To	24	36	48	60	72	84	96	108
36		331	395	452	524	759	831	903	976
48		358	407	488	570	813	895	976	1,058
60		344	596	687	777	868	959	1,049	1,302
72		362	624	723	823	1,085	1,185	1,284	1,384
84		380	651	760	869	1,140	1,248	1,357	1,628
96		398	678	796	914	1,194	1,312	1,430	1,710
108		417	706	833	960	1,249	1,376	1,503	1,792

		Series 37							
		Overall Finished Width							
Length	Up To	24	36	48	60	72	84	96	108
36		349	412	470	542	795	867	939	1,012
48		376	425	506	588	849	931	1,012	1,094
60		362	632	723	813	904	995	1,085	1,356
72		380	660	759	859	1,139	1,239	1,338	1,438
84		398	687	796	905	1,194	1,302	1,411	1,700
96		416	714	832	950	1,248	1,366	1,484	1,782
108		435	742	869	996	1,303	1,430	1,557	1,864

		Series 38							
		Overall Finished Width							
Length	Up To	24	36	48	60	72	84	96	108
36		389	450	510	582	875	947	1,019	1,092
48		416	465	546	628	929	1,011	1,092	1,174
60		402	712	803	893	984	1,075	1,165	1,476
72		420	740	839	939	1,259	1,359	1,458	1,558
84		438	767	876	985	1,314	1,422	1,531	1,860
96		456	794	912	1,030	1,368	1,486	1,604	1,942
108		475	822	949	1,076	1,423	1,550	1,677	2,024

FABRIC SHADES: Roman — Lined (Lining 01000)

Chart pricing includes board mount or headrail mount. Sizes and series numbers beyond what is listed in the charts below are available—please submit these quote requests via fax or email. **NOTE: For headrail mount:** manual—maximum width 133"; motorized—maximum width 91". For larger widths, please order board mount shades.

FLAT ROMAN SHADE

Series 07

Length Up To	Overall Finished Width							
	24	36	48	60	72	84	96	108
36	223	312	347	423	543	618	694	769
48	252	347	433	518	604	689	775	906
60	237	378	473	569	665	760	856	997
72	257	408	514	620	771	876	982	1,133
84	277	438	554	670	831	947	1,063	1,224
96	298	469	595	721	892	1,018	1,144	1,316
108	363	544	681	817	998	1,134	1,271	1,452

Series 08

Length Up To	Overall Finished Width							
	24	36	48	60	72	84	96	108
36	228	317	352	428	553	628	704	779
48	257	357	443	528	614	699	785	921
60	242	388	483	579	675	770	866	1,012
72	262	418	524	630	786	891	997	1,153
84	282	448	564	680	846	962	1,078	1,244
96	303	479	605	731	907	1,033	1,159	1,336
108	373	559	696	832	1,018	1,154	1,291	1,477

Series 09

Length Up To	Overall Finished Width							
	24	36	48	60	72	84	96	108
36	232	321	356	432	561	636	712	787
48	261	365	451	536	622	707	793	933
60	246	396	491	587	683	778	874	1,024
72	266	426	532	638	798	903	1,009	1,169
84	286	456	572	688	858	974	1,090	1,260
96	307	487	613	739	919	1,045	1,171	1,352
108	381	571	708	844	1,034	1,170	1,307	1,497

Series 10

Length Up To	Overall Finished Width							
	24	36	48	60	72	84	96	108
36	236	325	360	436	569	644	720	795
48	265	373	459	544	630	715	801	945
60	250	404	499	595	691	786	882	1,036
72	270	434	540	646	810	915	1,021	1,185
84	290	464	580	696	870	986	1,102	1,276
96	311	495	621	747	931	1,057	1,183	1,368
108	389	583	720	856	1,050	1,186	1,323	1,517

Series 11

Length Up To	Overall Finished Width							
	24	36	48	60	72	84	96	108
36	240	329	364	440	577	652	728	803
48	269	381	467	552	638	723	809	957
60	254	412	507	603	699	794	890	1,048
72	274	442	548	654	822	927	1,033	1,201
84	294	472	588	704	882	998	1,114	1,292
96	315	503	629	755	943	1,069	1,195	1,384
108	397	595	732	868	1,066	1,202	1,339	1,537

Series 12

Length Up To	Overall Finished Width							
	24	36	48	60	72	84	96	108
36	244	333	368	444	585	660	736	811
48	273	389	475	560	646	731	817	969
60	258	420	515	611	707	802	898	1,060
72	278	450	556	662	834	939	1,045	1,217
84	298	480	596	712	894	1,010	1,126	1,308
96	319	511	637	763	955	1,081	1,207	1,400
108	405	607	744	880	1,082	1,218	1,355	1,557

Series 13

Length Up To	Overall Finished Width							
	24	36	48	60	72	84	96	108
36	248	337	372	448	593	668	744	819
48	277	397	483	568	654	739	825	981
60	262	428	523	619	715	810	906	1,072
72	282	458	564	670	846	951	1,057	1,233
84	302	488	604	720	906	1,022	1,138	1,324
96	323	519	645	771	967	1,093	1,219	1,416
108	413	619	756	892	1,098	1,234	1,371	1,577

Series 14

Length Up To	Overall Finished Width							
	24	36	48	60	72	84	96	108
36	252	341	376	452	601	676	752	827
48	281	405	491	576	662	747	833	993
60	266	436	531	627	723	818	914	1,084
72	286	466	572	678	858	963	1,069	1,249
84	306	496	612	728	918	1,034	1,150	1,340
96	327	527	653	779	979	1,105	1,231	1,432
108	421	631	768	904	1,114	1,250	1,387	1,597

Series 15

Length Up To	Overall Finished Width							
	24	36	48	60	72	84	96	108
36	256	345	380	456	609	684	760	835
48	285	413	499	584	670	755	841	1,005
60	270	444	539	635	731	826	922	1,096
72	290	474	580	686	870	975	1,081	1,265
84	310	504	620	736	930	1,046	1,162	1,356
96	331	535	661	787	991	1,117	1,243	1,448
108	429	643	780	916	1,130	1,266	1,403	1,617

Series 16

Length Up To	Overall Finished Width							
	24	36	48	60	72	84	96	108
36	260	349	384	460	617	692	768	843
48	289	421	507	592	678	763	849	1,017
60	274	452	547	643	739	834	930	1,108
72	294	482	588	694	882	987	1,093	1,281
84	314	512	628	744	942	1,058	1,174	1,372
96	335	543	669	795	1,003	1,129	1,255	1,464
108	437	655	792	928	1,146	1,282	1,419	1,637

Series 17

Length Up To	Overall Finished Width							
	24	36	48	60	72	84	96	108
36	264	353	388	464	625	700	776	851
48	293	429	515	600	686	771	857	1,029
60	278	460	555	651	747	842	938	1,120
72	298	490	596	702	894	999	1,105	1,297
84	318	520	636	752	954	1,070	1,186	1,388
96	339	551	677	803	1,015	1,141	1,267	1,480
108	445	667	804	940	1,162	1,298	1,435	1,657

Series 18

Length Up To	Overall Finished Width							
	24	36	48	60	72	84	96	108
36	268	357	392	468	633	708	784	859
48	297	437	523	608	694	779	865	1,041
60	282	468	563	659	755	850	946	1,132
72	302	498	604	710	906	1,011	1,117	1,313
84	322	528	644	760	966	1,082	1,198	1,404
96	343	559	685	811	1,027	1,153	1,279	1,496
108	453	679	816	952	1,178	1,314	1,451	1,677

FABRIC SHADES: Roman — Lined (Lining 01000)

Chart pricing includes board mount or headrail mount. Sizes and series numbers beyond what is listed in the charts below are available—please submit these quote requests via fax or email. **NOTE: For headrail mount:** manual—maximum width 133"; motorized—maximum width 91". For larger widths, please order board mount shades.

FLAT ROMAN SHADE

		Series 19							
Length		Overall Finished Width							
Up To		24	36	48	60	72	84	96	108
36		272	361	396	472	641	716	792	867
48		301	445	531	616	702	787	873	1,053
60		286	476	571	667	763	858	954	1,144
72		306	506	612	718	918	1,023	1,129	1,329
84		326	536	652	768	978	1,094	1,210	1,420
96		347	567	693	819	1,039	1,165	1,291	1,512
108		461	691	828	964	1,194	1,330	1,467	1,697

		Series 20							
Length		Overall Finished Width							
Up To		24	36	48	60	72	84	96	108
36		276	365	400	476	649	724	800	875
48		305	453	539	624	710	795	881	1,065
60		290	484	579	675	771	866	962	1,156
72		310	514	620	726	930	1,035	1,141	1,345
84		330	544	660	776	990	1,106	1,222	1,436
96		351	575	701	827	1,051	1,177	1,303	1,528
108		469	703	840	976	1,210	1,346	1,483	1,717

		Series 21							
Length		Overall Finished Width							
Up To		24	36	48	60	72	84	96	108
36		280	369	404	480	657	732	808	883
48		309	461	547	632	718	803	889	1,077
60		294	492	587	683	779	874	970	1,168
72		314	522	628	734	942	1,047	1,153	1,361
84		334	552	668	784	1,002	1,118	1,234	1,452
96		355	583	709	835	1,063	1,189	1,315	1,544
108		477	715	852	988	1,226	1,362	1,499	1,737

		Series 22							
Length		Overall Finished Width							
Up To		24	36	48	60	72	84	96	108
36		284	373	408	484	665	740	816	891
48		313	469	555	640	726	811	897	1,089
60		298	500	595	691	787	882	978	1,180
72		318	530	636	742	954	1,059	1,165	1,377
84		338	560	676	792	1,014	1,130	1,246	1,468
96		359	591	717	843	1,075	1,201	1,327	1,560
108		485	727	864	1,000	1,242	1,378	1,515	1,757

		Series 23							
Length		Overall Finished Width							
Up To		24	36	48	60	72	84	96	108
36		288	377	412	488	673	748	824	899
48		317	477	563	648	734	819	905	1,101
60		302	508	603	699	795	890	986	1,192
72		322	538	644	750	966	1,071	1,177	1,393
84		342	568	684	800	1,026	1,142	1,258	1,484
96		363	599	725	851	1,087	1,213	1,339	1,576
108		493	739	876	1,012	1,258	1,394	1,531	1,777

		Series 24							
Length		Overall Finished Width							
Up To		24	36	48	60	72	84	96	108
36		292	381	416	492	681	756	832	907
48		321	485	571	656	742	827	913	1,113
60		306	516	611	707	803	898	994	1,204
72		326	546	652	758	978	1,083	1,189	1,409
84		346	576	692	808	1,038	1,154	1,270	1,500
96		367	607	733	859	1,099	1,225	1,351	1,592
108		501	751	888	1,024	1,274	1,410	1,547	1,797

		Series 25							
Length		Overall Finished Width							
Up To		24	36	48	60	72	84	96	108
36		298	387	422	498	693	768	844	919
48		327	497	583	668	754	839	925	1,131
60		312	528	623	719	815	910	1,006	1,222
72		332	558	664	770	996	1,101	1,207	1,433
84		352	588	704	820	1,056	1,172	1,288	1,524
96		373	619	745	871	1,117	1,243	1,369	1,616
108		513	769	906	1,042	1,298	1,434	1,571	1,827

		Series 26							
Length		Overall Finished Width							
Up To		24	36	48	60	72	84	96	108
36		302	391	426	502	701	776	852	927
48		331	505	591	676	762	847	933	1,143
60		316	536	631	727	823	918	1,014	1,234
72		336	566	672	778	1,008	1,113	1,219	1,449
84		356	596	712	828	1,068	1,184	1,300	1,540
96		377	627	753	879	1,129	1,255	1,381	1,632
108		521	781	918	1,054	1,314	1,450	1,587	1,847

		Series 27							
Length		Overall Finished Width							
Up To		24	36	48	60	72	84	96	108
36		306	395	430	506	709	784	860	935
48		335	513	599	684	770	855	941	1,155
60		320	544	639	735	831	926	1,022	1,246
72		340	574	680	786	1,020	1,125	1,231	1,465
84		360	604	720	836	1,080	1,196	1,312	1,556
96		381	635	761	887	1,141	1,267	1,393	1,648
108		529	793	930	1,066	1,330	1,466	1,603	1,867

		Series 28							
Length		Overall Finished Width							
Up To		24	36	48	60	72	84	96	108
36		310	399	434	510	717	792	868	943
48		339	521	607	692	778	863	949	1,167
60		324	552	647	743	839	934	1,030	1,258
72		344	582	688	794	1,032	1,137	1,243	1,481
84		364	612	728	844	1,092	1,208	1,324	1,572
96		385	643	769	895	1,153	1,279	1,405	1,664
108		537	805	942	1,078	1,346	1,482	1,619	1,887

		Series 29							
Length		Overall Finished Width							
Up To		24	36	48	60	72	84	96	108
36		314	403	438	514	725	800	876	951
48		343	529	615	700	786	871	957	1,179
60		328	560	655	751	847	942	1,038	1,270
72		348	590	696	802	1,044	1,149	1,255	1,497
84		368	620	736	852	1,104	1,220	1,336	1,588
96		389	651	777	903	1,165	1,291	1,417	1,680
108		545	817	954	1,090	1,362	1,498	1,635	1,907

		Series 30							
Length		Overall Finished Width							
Up To		24	36	48	60	72	84	96	108
36		320	409	444	520	737	812	888	963
48		349	541	627	712	798	883	969	1,197
60		334	572	667	763	859	954	1,050	1,288
72		354	602	708	814	1,062	1,167	1,273	1,521
84		374	632	748	864	1,122	1,238	1,354	1,612
96		395	663	789	915	1,183	1,309	1,435	1,704
108		557	835	972	1,108	1,386	1,522	1,659	1,937

FABRIC SHADES: Roman — Lined (Lining 01000)

Chart pricing includes board mount or headrail mount. Sizes and series numbers beyond what is listed in the charts below are available—please submit these quote requests via fax or email. **NOTE: For headrail mount:** manual—maximum width 133"; motorized—maximum width 91". For larger widths, please order board mount shades.

FLAT ROMAN SHADE

		Series 31							
		Overall Finished Width							
Length	Up To	24	36	48	60	72	84	96	108
36		323	412	447	523	743	818	894	969
48		352	547	633	718	804	889	975	1,206
60		337	578	673	769	865	960	1,056	1,297
72		357	608	714	820	1,071	1,176	1,282	1,533
84		377	638	754	870	1,131	1,247	1,363	1,624
96		398	669	795	921	1,192	1,318	1,444	1,716
108		563	844	981	1,117	1,398	1,534	1,671	1,952

		Series 32							
		Overall Finished Width							
Length	Up To	24	36	48	60	72	84	96	108
36		327	416	451	527	751	826	902	977
48		356	555	641	726	812	897	983	1,218
60		341	586	681	777	873	968	1,064	1,309
72		361	616	722	828	1,083	1,188	1,294	1,549
84		381	646	762	878	1,143	1,259	1,375	1,640
96		402	677	803	929	1,204	1,330	1,456	1,732
108		571	856	993	1,129	1,414	1,550	1,687	1,972

		Series 33							
		Overall Finished Width							
Length	Up To	24	36	48	60	72	84	96	108
36		332	421	456	532	761	836	912	987
48		361	565	651	736	822	907	993	1,233
60		346	596	691	787	883	978	1,074	1,324
72		366	626	732	838	1,098	1,203	1,309	1,569
84		386	656	772	888	1,158	1,274	1,390	1,660
96		407	687	813	939	1,219	1,345	1,471	1,752
108		581	871	1,008	1,144	1,434	1,570	1,707	1,997

		Series 34							
		Overall Finished Width							
Length	Up To	24	36	48	60	72	84	96	108
36		342	431	466	542	781	856	932	1,007
48		371	585	671	756	842	927	1,013	1,263
60		356	616	711	807	903	998	1,094	1,354
72		376	646	752	858	1,128	1,233	1,339	1,609
84		396	676	792	908	1,188	1,304	1,420	1,700
96		417	707	833	959	1,249	1,375	1,501	1,792
108		601	901	1,038	1,174	1,474	1,610	1,747	2,047

		Series 35							
		Overall Finished Width							
Length	Up To	24	36	48	60	72	84	96	108
36		352	441	476	552	801	876	952	1,027
48		381	605	691	776	862	947	1,033	1,293
60		366	636	731	827	923	1,018	1,114	1,384
72		386	666	772	878	1,158	1,263	1,369	1,649
84		406	696	812	928	1,218	1,334	1,450	1,740
96		427	727	853	979	1,279	1,405	1,531	1,832
108		621	931	1,068	1,204	1,514	1,650	1,787	2,097

		Series 36							
		Overall Finished Width							
Length	Up To	24	36	48	60	72	84	96	108
36		364	453	488	564	825	900	976	1,051
48		393	629	715	800	886	971	1,057	1,329
60		378	660	755	851	947	1,042	1,138	1,420
72		398	690	796	902	1,194	1,299	1,405	1,697
84		418	720	836	952	1,254	1,370	1,486	1,788
96		439	751	877	1,003	1,315	1,441	1,567	1,880
108		645	967	1,104	1,240	1,562	1,698	1,835	2,157

		Series 37							
		Overall Finished Width							
Length	Up To	24	36	48	60	72	84	96	108
36		382	471	506	582	861	936	1,012	1,087
48		411	665	751	836	922	1,007	1,093	1,383
60		396	696	791	887	983	1,078	1,174	1,474
72		416	726	832	938	1,248	1,353	1,459	1,769
84		436	756	872	988	1,308	1,424	1,540	1,860
96		457	787	913	1,039	1,369	1,495	1,621	1,952
108		681	1,021	1,158	1,294	1,634	1,770	1,907	2,247

		Series 38							
		Overall Finished Width							
Length	Up To	24	36	48	60	72	84	96	108
36		422	511	546	622	941	1,016	1,092	1,167
48		451	745	831	916	1,002	1,087	1,173	1,503
60		436	776	871	967	1,063	1,158	1,254	1,594
72		456	806	912	1,018	1,368	1,473	1,579	1,929
84		476	836	952	1,068	1,428	1,544	1,660	2,020
96		497	867	993	1,119	1,489	1,615	1,741	2,112
108		761	1,141	1,278	1,414	1,794	1,930	2,067	2,447

FABRIC SHADES: Roman — Unlined

Chart pricing includes board mount or headrail mount. Sizes and series numbers beyond what is listed in the charts below are available—please submit these quote requests via fax or email. **NOTE: For headrail mount:** manual—maximum width 141"; motorized—maximum width 100". For larger widths, please order board mount shades.

FRONT SLAT & BACK SLAT ROMAN SHADE

		Series 07							
		Overall Finished Width							
Length Up To		24	36	48	60	72	84	96	108
36		204	265	336	415	514	593	672	750
48		234	291	381	471	582	672	762	851
60		224	346	447	548	649	750	851	973
72		246	379	492	604	737	850	962	1,074
84		269	413	537	660	805	928	1,052	1,196
96		291	447	582	716	872	1,007	1,142	1,297
108		313	480	626	772	939	1,085	1,231	1,398

		Series 08							
		Overall Finished Width							
Length Up To		24	36	48	60	72	84	96	108
36		209	270	341	420	524	603	682	760
48		239	296	386	476	592	682	772	861
60		229	356	457	558	659	760	861	988
72		251	389	502	614	752	865	977	1,089
84		274	423	547	670	820	943	1,067	1,216
96		296	457	592	726	887	1,022	1,157	1,317
108		318	490	636	782	954	1,100	1,246	1,418

		Series 09							
		Overall Finished Width							
Length Up To		24	36	48	60	72	84	96	108
36		213	273	345	424	532	611	690	768
48		243	300	390	480	600	690	780	869
60		233	364	465	566	667	768	869	1,000
72		255	397	510	622	764	877	989	1,101
84		278	431	555	678	832	955	1,079	1,232
96		300	465	600	734	899	1,034	1,169	1,333
108		322	498	644	790	966	1,112	1,258	1,434

		Series 10							
		Overall Finished Width							
Length Up To		24	36	48	60	72	84	96	108
36		217	277	349	428	540	619	698	776
48		247	304	394	484	608	698	788	877
60		237	372	473	574	675	776	877	1,012
72		259	405	518	630	776	889	1,001	1,113
84		282	439	563	686	844	967	1,091	1,248
96		304	473	608	742	911	1,046	1,181	1,349
108		326	506	652	798	978	1,124	1,270	1,450

		Series 11							
		Overall Finished Width							
Length Up To		24	36	48	60	72	84	96	108
36		221	281	353	432	548	627	706	784
48		251	308	398	488	616	706	796	885
60		241	380	481	582	683	784	885	1,024
72		263	413	526	638	788	901	1,013	1,125
84		286	447	571	694	856	979	1,103	1,264
96		308	481	616	750	923	1,058	1,193	1,365
108		330	514	660	806	990	1,136	1,282	1,466

		Series 12							
		Overall Finished Width							
Length Up To		24	36	48	60	72	84	96	108
36		225	284	357	436	556	635	714	792
48		255	312	402	492	624	714	804	893
60		245	388	489	590	691	792	893	1,036
72		267	421	534	646	800	913	1,025	1,137
84		290	455	579	702	868	991	1,115	1,280
96		312	489	624	758	935	1,070	1,205	1,381
108		334	522	668	814	1,002	1,148	1,294	1,482

		Series 13							
		Overall Finished Width							
Length Up To		24	36	48	60	72	84	96	108
36		229	288	361	440	564	643	722	800
48		259	316	406	496	632	722	812	901
60		249	396	497	598	699	800	901	1,048
72		271	429	542	654	812	925	1,037	1,149
84		294	463	587	710	880	1,003	1,127	1,296
96		316	497	632	766	947	1,082	1,217	1,397
108		338	530	676	822	1,014	1,160	1,306	1,498

		Series 14							
		Overall Finished Width							
Length Up To		24	36	48	60	72	84	96	108
36		233	291	365	444	572	651	730	808
48		263	320	410	500	640	730	820	909
60		253	404	505	606	707	808	909	1,060
72		275	437	550	662	824	937	1,049	1,161
84		298	471	595	718	892	1,015	1,139	1,312
96		320	505	640	774	959	1,094	1,229	1,413
108		342	538	684	830	1,026	1,172	1,318	1,514

		Series 15							
		Overall Finished Width							
Length Up To		24	36	48	60	72	84	96	108
36		237	295	369	448	580	659	738	816
48		267	324	414	504	648	738	828	917
60		257	412	513	614	715	816	917	1,072
72		279	445	558	670	836	949	1,061	1,173
84		302	479	603	726	904	1,027	1,151	1,328
96		324	513	648	782	971	1,106	1,241	1,429
108		346	546	692	838	1,038	1,184	1,330	1,530

		Series 16							
		Overall Finished Width							
Length Up To		24	36	48	60	72	84	96	108
36		241	299	373	452	588	667	746	824
48		271	328	418	508	656	746	836	925
60		261	420	521	622	723	824	925	1,084
72		283	453	566	678	848	961	1,073	1,185
84		306	487	611	734	916	1,039	1,163	1,344
96		328	521	656	790	983	1,118	1,253	1,445
108		350	554	700	846	1,050	1,196	1,342	1,546

		Series 17							
		Overall Finished Width							
Length Up To		24	36	48	60	72	84	96	108
36		245	302	377	456	596	675	754	832
48		275	332	422	512	664	754	844	933
60		265	428	529	630	731	832	933	1,096
72		287	461	574	686	860	973	1,085	1,197
84		310	495	619	742	928	1,051	1,175	1,360
96		332	529	664	798	995	1,130	1,265	1,461
108		354	562	708	854	1,062	1,208	1,354	1,562

		Series 18							
		Overall Finished Width							
Length Up To		24	36	48	60	72	84	96	108
36		249	306	381	460	604	683	762	840
48		279	336	426	516	672	762	852	941
60		269	436	537	638	739	840	941	1,108
72		291	469	582	694	872	985	1,097	1,209
84		314	503	627	750	940	1,063	1,187	1,376
96		336	537	672	806	1,007	1,142	1,277	1,477
108		358	570	716	862	1,074	1,220	1,366	1,578

FABRIC SHADES: Roman — Unlined

Chart pricing includes board mount or headrail mount. Sizes and series numbers beyond what is listed in the charts below are available—please submit these quote requests via fax or email. **NOTE: For headrail mount:** manual—maximum width 141"; motorized—maximum width 100". For larger widths, please order board mount shades.

FRONT SLAT & BACK SLAT ROMAN SHADE

		Series 19							
		Overall Finished Width							
Length Up To		24	36	48	60	72	84	96	108
36		253	309	385	464	612	691	770	848
48		283	340	430	520	680	770	860	949
60		273	444	545	646	747	848	949	1,120
72		295	477	590	702	884	997	1,109	1,221
84		318	511	635	758	952	1,075	1,199	1,392
96		340	545	680	814	1,019	1,154	1,289	1,493
108		362	578	724	870	1,086	1,232	1,378	1,594

		Series 20							
		Overall Finished Width							
Length Up To		24	36	48	60	72	84	96	108
36		257	313	389	468	620	699	778	856
48		287	344	434	524	688	778	868	957
60		277	452	553	654	755	856	957	1,132
72		299	485	598	710	896	1,009	1,121	1,233
84		322	519	643	766	964	1,087	1,211	1,408
96		344	553	688	822	1,031	1,166	1,301	1,509
108		366	586	732	878	1,098	1,244	1,390	1,610

		Series 21							
		Overall Finished Width							
Length Up To		24	36	48	60	72	84	96	108
36		261	317	393	472	628	707	786	864
48		291	348	438	528	696	786	876	965
60		281	460	561	662	763	864	965	1,144
72		303	493	606	718	908	1,021	1,133	1,245
84		326	527	651	774	976	1,099	1,223	1,424
96		348	561	696	830	1,043	1,178	1,313	1,525
108		370	594	740	886	1,110	1,256	1,402	1,626

		Series 22							
		Overall Finished Width							
Length Up To		24	36	48	60	72	84	96	108
36		265	320	397	476	636	715	794	872
48		295	352	442	532	704	794	884	973
60		285	468	569	670	771	872	973	1,156
72		307	501	614	726	920	1,033	1,145	1,257
84		330	535	659	782	988	1,111	1,235	1,440
96		352	569	704	838	1,055	1,190	1,325	1,541
108		374	602	748	894	1,122	1,268	1,414	1,642

		Series 23							
		Overall Finished Width							
Length Up To		24	36	48	60	72	84	96	108
36		269	324	401	480	644	723	802	880
48		299	356	446	536	712	802	892	981
60		289	476	577	678	779	880	981	1,168
72		311	509	622	734	932	1,045	1,157	1,269
84		334	543	667	790	1,000	1,123	1,247	1,456
96		356	577	712	846	1,067	1,202	1,337	1,557
108		378	610	756	902	1,134	1,280	1,426	1,658

		Series 24							
		Overall Finished Width							
Length Up To		24	36	48	60	72	84	96	108
36		273	327	405	484	652	731	810	888
48		303	360	450	540	720	810	900	989
60		293	484	585	686	787	888	989	1,180
72		315	517	630	742	944	1,057	1,169	1,281
84		338	551	675	798	1,012	1,135	1,259	1,472
96		360	585	720	854	1,079	1,214	1,349	1,573
108		382	618	764	910	1,146	1,292	1,438	1,674

		Series 25							
		Overall Finished Width							
Length Up To		24	36	48	60	72	84	96	108
36		279	333	411	490	664	743	822	900
48		309	366	456	546	732	822	912	1,001
60		299	496	597	698	799	900	1,001	1,198
72		321	529	642	754	962	1,075	1,187	1,299
84		344	563	687	810	1,030	1,153	1,277	1,496
96		366	597	732	866	1,097	1,232	1,367	1,597
108		388	630	776	922	1,164	1,310	1,456	1,698

		Series 26							
		Overall Finished Width							
Length Up To		24	36	48	60	72	84	96	108
36		283	336	415	494	672	751	830	908
48		313	370	460	550	740	830	920	1,009
60		303	504	605	706	807	908	1,009	1,210
72		325	537	650	762	974	1,087	1,199	1,311
84		348	571	695	818	1,042	1,165	1,289	1,512
96		370	605	740	874	1,109	1,244	1,379	1,613
108		392	638	784	930	1,176	1,322	1,468	1,714

		Series 27							
		Overall Finished Width							
Length Up To		24	36	48	60	72	84	96	108
36		287	340	419	498	680	759	838	916
48		317	374	464	554	748	838	928	1,017
60		307	512	613	714	815	916	1,017	1,222
72		329	545	658	770	986	1,099	1,211	1,323
84		352	579	703	826	1,054	1,177	1,301	1,528
96		374	613	748	882	1,121	1,256	1,391	1,629
108		396	646	792	938	1,188	1,334	1,480	1,730

		Series 28							
		Overall Finished Width							
Length Up To		24	36	48	60	72	84	96	108
36		291	344	423	502	688	767	846	924
48		321	378	468	558	756	846	936	1,025
60		311	520	621	722	823	924	1,025	1,234
72		333	553	666	778	998	1,111	1,223	1,335
84		356	587	711	834	1,066	1,189	1,313	1,544
96		378	621	756	890	1,133	1,268	1,403	1,645
108		400	654	800	946	1,200	1,346	1,492	1,746

		Series 29							
		Overall Finished Width							
Length Up To		24	36	48	60	72	84	96	108
36		295	347	427	506	696	775	854	932
48		325	382	472	562	764	854	944	1,033
60		315	528	629	730	831	932	1,033	1,246
72		337	561	674	786	1,010	1,123	1,235	1,347
84		360	595	719	842	1,078	1,201	1,325	1,560
96		382	629	764	898	1,145	1,280	1,415	1,661
108		404	662	808	954	1,212	1,358	1,504	1,762

		Series 30							
		Overall Finished Width							
Length Up To		24	36	48	60	72	84	96	108
36		301	353	433	512	708	787	866	944
48		331	388	478	568	776	866	956	1,045
60		321	540	641	742	843	944	1,045	1,264
72		343	573	686	798	1,028	1,141	1,253	1,365
84		366	607	731	854	1,096	1,219	1,343	1,584
96		388	641	776	910	1,163	1,298	1,433	1,685
108		410	674	820	966	1,230	1,376	1,522	1,786

FABRIC SHADES: Roman — Unlined

Chart pricing includes board mount or headrail mount. Sizes and series numbers beyond what is listed in the charts below are available—please submit these quote requests via fax or email. **NOTE: For headrail mount:** manual—maximum width 141"; motorized—maximum width 100". For larger widths, please order board mount shades.

FRONT SLAT & BACK SLAT ROMAN SHADE

		Series 31							
		Overall Finished Width							
Length	Up To	24	36	48	60	72	84	96	108
36		304	355	436	515	714	793	872	950
48		334	391	481	571	782	872	962	1,051
60		324	546	647	748	849	950	1,051	1,273
72		346	579	692	804	1,037	1,150	1,262	1,374
84		369	613	737	860	1,105	1,228	1,352	1,596
96		391	647	782	916	1,172	1,307	1,442	1,697
108		413	680	826	972	1,239	1,385	1,531	1,798

		Series 32							
		Overall Finished Width							
Length	Up To	24	36	48	60	72	84	96	108
36		308	359	440	519	722	801	880	958
48		338	395	485	575	790	880	970	1,059
60		328	554	655	756	857	958	1,059	1,285
72		350	587	700	812	1,049	1,162	1,274	1,386
84		373	621	745	868	1,117	1,240	1,364	1,612
96		395	655	790	924	1,184	1,319	1,454	1,713
108		417	688	834	980	1,251	1,397	1,543	1,814

		Series 33							
		Overall Finished Width							
Length	Up To	24	36	48	60	72	84	96	108
36		313	384	445	524	732	811	890	968
48		343	400	490	580	800	890	980	1,069
60		333	564	665	766	867	968	1,069	1,300
72		355	597	710	822	1,064	1,177	1,289	1,401
84		378	631	755	878	1,132	1,255	1,379	1,632
96		400	665	800	934	1,199	1,334	1,469	1,733
108		422	698	844	990	1,266	1,412	1,558	1,834

		Series 34							
		Overall Finished Width							
Length	Up To	24	36	48	60	72	84	96	108
36		323	393	455	534	752	831	910	988
48		353	410	500	590	820	910	1,000	1,089
60		343	584	685	786	887	988	1,089	1,330
72		365	617	730	842	1,094	1,207	1,319	1,431
84		388	651	775	898	1,162	1,285	1,409	1,672
96		410	685	820	954	1,229	1,364	1,499	1,773
108		432	718	864	1,010	1,296	1,442	1,588	1,874

		Series 35							
		Overall Finished Width							
Length	Up To	24	36	48	60	72	84	96	108
36		333	403	465	544	772	851	930	1,008
48		363	420	510	600	840	930	1,020	1,109
60		353	604	705	806	907	1,008	1,109	1,360
72		375	637	750	862	1,124	1,237	1,349	1,461
84		398	671	795	918	1,192	1,315	1,439	1,712
96		420	705	840	974	1,259	1,394	1,529	1,813
108		442	738	884	1,030	1,326	1,472	1,618	1,914

		Series 36							
		Overall Finished Width							
Length	Up To	24	36	48	60	72	84	96	108
36		345	414	477	556	796	875	954	1,032
48		375	432	522	612	864	954	1,044	1,133
60		365	628	729	830	931	1,032	1,133	1,396
72		387	661	774	886	1,160	1,273	1,385	1,497
84		410	695	819	942	1,228	1,351	1,475	1,760
96		432	729	864	998	1,295	1,430	1,565	1,861
108		454	762	908	1,054	1,362	1,508	1,654	1,962

		Series 37							
		Overall Finished Width							
Length	Up To	24	36	48	60	72	84	96	108
36		363	431	495	574	832	911	990	1,068
48		393	450	540	630	900	990	1,080	1,169
60		383	664	765	866	967	1,068	1,169	1,450
72		405	697	810	922	1,214	1,327	1,439	1,551
84		428	731	855	978	1,282	1,405	1,529	1,832
96		450	765	900	1,034	1,349	1,484	1,619	1,933
108		472	798	944	1,090	1,416	1,562	1,708	2,034

		Series 38							
		Overall Finished Width							
Length	Up To	24	36	48	60	72	84	96	108
36		403	469	535	614	912	991	1,070	1,148
48		433	490	580	670	980	1,070	1,160	1,249
60		423	744	845	946	1,047	1,148	1,249	1,570
72		445	777	890	1,002	1,334	1,447	1,559	1,671
84		468	811	935	1,058	1,402	1,525	1,649	1,992
96		490	845	980	1,114	1,469	1,604	1,739	2,093
108		512	878	1,024	1,170	1,536	1,682	1,828	2,194

FABRIC SHADES: Roman — Lined (Lining 01000)

Chart pricing includes board mount or headrail mount. Sizes and series numbers beyond what is listed in the charts below are available—please submit these quote requests via fax or email. **NOTE: For headrail mount:** manual—maximum width 115"; motorized—maximum width 81". For larger widths, please order board mount shades.

FRONT SLAT & BACK SLAT ROMAN SHADE

		Series 07							
		Overall Finished Width							
Length Up To		24	36	48	60	72	84	96	108
36		238	301	375	458	585	668	750	832
48		273	330	425	520	660	755	850	945
60		260	413	520	627	735	842	950	1,102
72		285	450	570	690	855	975	1,095	1,214
84		310	488	620	752	930	1,062	1,194	1,372
96		335	525	670	815	1,005	1,149	1,294	1,484
108		360	562	720	877	1,079	1,237	1,394	1,596

		Series 08							
		Overall Finished Width							
Length Up To		24	36	48	60	72	84	96	108
36		243	306	380	463	595	678	760	842
48		278	335	430	525	670	765	860	955
60		265	423	530	637	745	852	960	1,117
72		290	460	580	700	870	990	1,110	1,229
84		315	498	630	762	945	1,077	1,209	1,392
96		340	535	680	825	1,020	1,164	1,309	1,504
108		365	572	730	887	1,094	1,252	1,409	1,616

		Series 09							
		Overall Finished Width							
Length Up To		24	36	48	60	72	84	96	108
36		247	310	384	467	603	686	768	850
48		282	339	434	529	678	773	868	963
60		269	431	538	645	753	860	968	1,129
72		294	468	588	708	882	1,002	1,122	1,241
84		319	506	638	770	957	1,089	1,221	1,408
96		344	543	688	833	1,032	1,176	1,321	1,520
108		369	580	738	895	1,106	1,264	1,421	1,632

		Series 10							
		Overall Finished Width							
Length Up To		24	36	48	60	72	84	96	108
36		251	313	388	471	611	694	776	858
48		286	343	438	533	686	781	876	971
60		273	439	546	653	761	868	976	1,141
72		298	476	596	716	894	1,014	1,134	1,253
84		323	514	646	778	969	1,101	1,233	1,424
96		348	551	696	841	1,044	1,188	1,333	1,536
108		373	588	746	903	1,118	1,276	1,433	1,648

		Series 11							
		Overall Finished Width							
Length Up To		24	36	48	60	72	84	96	108
36		255	317	392	475	619	702	784	866
48		290	347	442	537	694	789	884	979
60		277	447	554	661	769	876	984	1,153
72		302	484	604	724	906	1,026	1,146	1,265
84		327	522	654	786	981	1,113	1,245	1,440
96		352	559	704	849	1,056	1,200	1,345	1,552
108		377	596	754	911	1,130	1,288	1,445	1,664

		Series 12							
		Overall Finished Width							
Length Up To		24	36	48	60	72	84	96	108
36		259	320	396	479	627	710	792	874
48		294	351	446	541	702	797	892	987
60		281	455	562	669	777	884	992	1,165
72		306	492	612	732	918	1,038	1,158	1,277
84		331	530	662	794	993	1,125	1,257	1,456
96		356	567	712	857	1,068	1,212	1,357	1,568
108		381	604	762	919	1,142	1,300	1,457	1,680

		Series 13							
		Overall Finished Width							
Length Up To		24	36	48	60	72	84	96	108
36		263	324	400	483	635	718	800	882
48		298	355	450	545	710	805	900	995
60		285	463	570	677	785	892	1,000	1,177
72		310	500	620	740	930	1,050	1,170	1,289
84		335	538	670	802	1,005	1,137	1,269	1,472
96		360	575	720	865	1,080	1,224	1,369	1,584
108		385	612	770	927	1,154	1,312	1,469	1,696

		Series 14							
		Overall Finished Width							
Length Up To		24	36	48	60	72	84	96	108
36		267	328	404	487	643	726	808	890
48		302	359	454	549	718	813	908	1,003
60		289	471	578	685	793	900	1,008	1,189
72		314	508	628	748	942	1,062	1,182	1,301
84		339	546	678	810	1,017	1,149	1,281	1,488
96		364	583	728	873	1,092	1,236	1,381	1,600
108		389	620	778	935	1,166	1,324	1,481	1,712

		Series 15							
		Overall Finished Width							
Length Up To		24	36	48	60	72	84	96	108
36		271	331	408	491	651	734	816	898
48		306	363	458	553	726	821	916	1,011
60		293	479	586	693	801	908	1,016	1,201
72		318	516	636	756	954	1,074	1,194	1,313
84		343	554	686	818	1,029	1,161	1,293	1,504
96		368	591	736	881	1,104	1,248	1,393	1,616
108		393	628	786	943	1,178	1,336	1,493	1,728

		Series 16							
		Overall Finished Width							
Length Up To		24	36	48	60	72	84	96	108
36		275	335	412	495	659	742	824	906
48		310	367	462	557	734	829	924	1,019
60		297	487	594	701	809	916	1,024	1,213
72		322	524	644	764	966	1,086	1,206	1,325
84		347	562	694	826	1,041	1,173	1,305	1,520
96		372	599	744	889	1,116	1,260	1,405	1,632
108		397	636	794	951	1,190	1,348	1,505	1,744

		Series 17							
		Overall Finished Width							
Length Up To		24	36	48	60	72	84	96	108
36		279	338	416	499	667	750	832	914
48		314	371	466	561	742	837	932	1,027
60		301	495	602	709	817	924	1,032	1,225
72		326	532	652	772	978	1,098	1,218	1,337
84		351	570	702	834	1,053	1,185	1,317	1,536
96		376	607	752	897	1,128	1,272	1,417	1,648
108		401	644	802	959	1,202	1,360	1,517	1,760

		Series 18							
		Overall Finished Width							
Length Up To		24	36	48	60	72	84	96	108
36		283	342	420	503	675	758	840	922
48		318	375	470	565	750	845	940	1,035
60		305	503	610	717	825	932	1,040	1,237
72		330	540	660	780	990	1,110	1,230	1,349
84		355	578	710	842	1,065	1,197	1,329	1,552
96		380	615	760	905	1,140	1,284	1,429	1,664
108		405	652	810	967	1,214	1,372	1,529	1,776

FABRIC SHADES: Roman — Lined (Lining 01000)

Chart pricing includes board mount or headrail mount. Sizes and series numbers beyond what is listed in the charts below are available—please submit these quote requests via fax or email. **NOTE: For headrail mount:** manual—maximum width 115"; motorized—maximum width 81". For larger widths, please order board mount shades.

FRONT SLAT & BACK SLAT ROMAN SHADE

		Series 19							
		Overall Finished Width							
Length Up To		24	36	48	60	72	84	96	108
36		287	346	424	507	683	766	848	930
48		322	379	474	569	758	853	948	1,043
60		309	511	618	725	833	940	1,048	1,249
72		334	548	668	788	1,002	1,122	1,242	1,361
84		359	586	718	850	1,077	1,209	1,341	1,568
96		384	623	768	913	1,152	1,296	1,441	1,680
108		409	660	818	975	1,226	1,384	1,541	1,792

		Series 20							
		Overall Finished Width							
Length Up To		24	36	48	60	72	84	96	108
36		291	349	428	511	691	774	856	938
48		326	383	478	573	766	861	956	1,051
60		313	519	626	733	841	948	1,056	1,261
72		338	556	676	796	1,014	1,134	1,254	1,373
84		363	594	726	858	1,089	1,221	1,353	1,584
96		388	631	776	921	1,164	1,308	1,453	1,696
108		413	668	826	983	1,238	1,396	1,553	1,808

		Series 21							
		Overall Finished Width							
Length Up To		24	36	48	60	72	84	96	108
36		295	353	432	515	699	782	864	946
48		330	387	482	577	774	869	964	1,059
60		317	527	634	741	849	956	1,064	1,273
72		342	564	684	804	1,026	1,146	1,266	1,385
84		367	602	734	866	1,101	1,233	1,365	1,600
96		392	639	784	929	1,176	1,320	1,465	1,712
108		417	676	834	991	1,250	1,408	1,565	1,824

		Series 22							
		Overall Finished Width							
Length Up To		24	36	48	60	72	84	96	108
36		299	356	436	519	707	790	872	954
48		334	391	486	581	782	877	972	1,067
60		321	535	642	749	857	964	1,072	1,285
72		346	572	692	812	1,038	1,158	1,278	1,397
84		371	610	742	874	1,113	1,245	1,377	1,616
96		396	647	792	937	1,188	1,332	1,477	1,728
108		421	684	842	999	1,262	1,420	1,577	1,840

		Series 23							
		Overall Finished Width							
Length Up To		24	36	48	60	72	84	96	108
36		303	360	440	523	715	798	880	962
48		338	395	490	585	790	885	980	1,075
60		325	543	650	757	865	972	1,080	1,297
72		350	580	700	820	1,050	1,170	1,290	1,409
84		375	618	750	882	1,125	1,257	1,389	1,632
96		400	655	800	945	1,200	1,344	1,489	1,744
108		425	692	850	1,007	1,274	1,432	1,589	1,856

		Series 24							
		Overall Finished Width							
Length Up To		24	36	48	60	72	84	96	108
36		307	364	444	527	723	806	888	970
48		342	399	494	589	798	893	988	1,083
60		329	551	658	765	873	980	1,088	1,309
72		354	588	708	828	1,062	1,182	1,302	1,421
84		379	626	758	890	1,137	1,269	1,401	1,648
96		404	663	808	953	1,212	1,356	1,501	1,760
108		429	700	858	1,015	1,286	1,444	1,601	1,872

		Series 25							
		Overall Finished Width							
Length Up To		24	36	48	60	72	84	96	108
36		313	369	450	533	735	818	900	982
48		348	405	500	595	810	905	1,000	1,095
60		335	563	670	777	885	992	1,100	1,327
72		360	600	720	840	1,080	1,200	1,320	1,439
84		385	638	770	902	1,155	1,287	1,419	1,672
96		410	675	820	965	1,230	1,374	1,519	1,784
108		435	712	870	1,027	1,304	1,462	1,619	1,896

		Series 26							
		Overall Finished Width							
Length Up To		24	36	48	60	72	84	96	108
36		317	373	454	537	743	826	908	990
48		352	409	504	599	818	913	1,008	1,103
60		339	571	678	785	893	1,000	1,108	1,339
72		364	608	728	848	1,092	1,212	1,332	1,451
84		389	646	778	910	1,167	1,299	1,431	1,688
96		414	683	828	973	1,242	1,386	1,531	1,800
108		439	720	878	1,035	1,316	1,474	1,631	1,912

		Series 27							
		Overall Finished Width							
Length Up To		24	36	48	60	72	84	96	108
36		321	376	458	541	751	834	916	998
48		356	413	508	603	826	921	1,016	1,111
60		343	579	686	793	901	1,008	1,116	1,351
72		368	616	736	856	1,104	1,224	1,344	1,463
84		393	654	786	918	1,179	1,311	1,443	1,704
96		418	691	836	981	1,254	1,398	1,543	1,816
108		443	728	886	1,043	1,328	1,486	1,643	1,928

		Series 28							
		Overall Finished Width							
Length Up To		24	36	48	60	72	84	96	108
36		325	380	462	545	759	842	924	1,006
48		360	417	512	607	834	929	1,024	1,119
60		347	587	694	801	909	1,016	1,124	1,363
72		372	624	744	864	1,116	1,236	1,356	1,475
84		397	662	794	926	1,191	1,323	1,455	1,720
96		422	699	844	989	1,266	1,410	1,555	1,832
108		447	736	894	1,051	1,340	1,498	1,655	1,944

		Series 29							
		Overall Finished Width							
Length Up To		24	36	48	60	72	84	96	108
36		329	383	466	549	767	850	932	1,014
48		364	421	516	611	842	937	1,032	1,127
60		351	595	702	809	917	1,024	1,132	1,375
72		376	632	752	872	1,128	1,248	1,368	1,487
84		401	670	802	934	1,203	1,335	1,467	1,736
96		426	707	852	997	1,278	1,422	1,567	1,848
108		451	744	902	1,059	1,352	1,510	1,667	1,960

		Series 30							
		Overall Finished Width							
Length Up To		24	36	48	60	72	84	96	108
36		335	389	472	555	779	862	944	1,026
48		370	427	522	617	854	949	1,044	1,139
60		357	607	714	821	929	1,036	1,144	1,393
72		382	644	764	884	1,146	1,266	1,386	1,505
84		407	682	814	946	1,221	1,353	1,485	1,760
96		432	719	864	1,009	1,296	1,440	1,585	1,872
108		457	756	914	1,071	1,370	1,528	1,685	1,984

FABRIC SHADES: Roman — Lined (Lining 01000)

Chart pricing includes board mount or headrail mount. Sizes and series numbers beyond what is listed in the charts below are available—please submit these quote requests via fax or email. **NOTE: For headrail mount:** manual—maximum width 115"; motorized—maximum width 81". For larger widths, please order board mount shades.

FRONT SLAT & BACK SLAT ROMAN SHADE

		Series 31							
		Overall Finished Width							
Length Up To		24	36	48	60	72	84	96	108
36		338	391	475	558	785	868	950	1,032
48		373	430	525	620	860	955	1,050	1,145
60		360	613	720	827	935	1,042	1,150	1,402
72		385	650	770	890	1,155	1,275	1,395	1,514
84		410	688	820	952	1,230	1,362	1,494	1,772
96		435	725	870	1,015	1,305	1,449	1,594	1,884
108		460	762	920	1,077	1,379	1,537	1,694	1,996

		Series 32							
		Overall Finished Width							
Length Up To		24	36	48	60	72	84	96	108
36		342	395	479	562	793	876	958	1,040
48		377	434	529	624	868	963	1,058	1,153
60		364	621	728	835	943	1,050	1,158	1,414
72		389	658	778	898	1,167	1,287	1,407	1,526
84		414	696	828	960	1,242	1,374	1,506	1,788
96		439	733	878	1,023	1,317	1,461	1,606	1,900
108		464	770	928	1,085	1,391	1,549	1,706	2,012

		Series 33							
		Overall Finished Width							
Length Up To		24	36	48	60	72	84	96	108
36		347	422	484	567	803	886	968	1,050
48		382	439	534	629	878	973	1,068	1,163
60		369	631	738	845	953	1,060	1,168	1,429
72		394	668	788	908	1,182	1,302	1,422	1,541
84		419	706	838	970	1,257	1,389	1,521	1,808
96		444	743	888	1,033	1,332	1,476	1,621	1,920
108		469	780	938	1,095	1,406	1,564	1,721	2,032

		Series 34							
		Overall Finished Width							
Length Up To		24	36	48	60	72	84	96	108
36		357	431	494	577	823	906	988	1,070
48		392	449	544	639	898	993	1,088	1,183
60		379	651	758	865	973	1,080	1,188	1,459
72		404	688	808	928	1,212	1,332	1,452	1,571
84		429	726	858	990	1,287	1,419	1,551	1,848
96		454	763	908	1,053	1,362	1,506	1,651	1,960
108		479	800	958	1,115	1,436	1,594	1,751	2,072

		Series 35							
		Overall Finished Width							
Length Up To		24	36	48	60	72	84	96	108
36		367	441	504	587	843	926	1,008	1,090
48		402	459	554	649	918	1,013	1,108	1,203
60		389	671	778	885	993	1,100	1,208	1,489
72		414	708	828	948	1,242	1,362	1,482	1,601
84		439	746	878	1,010	1,317	1,449	1,581	1,888
96		464	783	928	1,073	1,392	1,536	1,681	2,000
108		489	820	978	1,135	1,466	1,624	1,781	2,112

		Series 36							
		Overall Finished Width							
Length Up To		24	36	48	60	72	84	96	108
36		379	452	516	599	867	950	1,032	1,114
48		414	471	566	661	942	1,037	1,132	1,227
60		401	695	802	909	1,017	1,124	1,232	1,525
72		426	732	852	972	1,278	1,398	1,518	1,637
84		451	770	902	1,034	1,353	1,485	1,617	1,936
96		476	807	952	1,097	1,428	1,572	1,717	2,048
108		501	844	1,002	1,159	1,502	1,660	1,817	2,160

		Series 37							
		Overall Finished Width							
Length Up To		24	36	48	60	72	84	96	108
36		397	469	534	617	903	986	1,068	1,150
48		432	489	584	679	978	1,073	1,168	1,263
60		419	731	838	945	1,053	1,160	1,268	1,579
72		444	768	888	1,008	1,332	1,452	1,572	1,691
84		469	806	938	1,070	1,407	1,539	1,671	2,008
96		494	843	988	1,133	1,482	1,626	1,771	2,120
108		519	880	1,038	1,195	1,556	1,714	1,871	2,232

		Series 38							
		Overall Finished Width							
Length Up To		24	36	48	60	72	84	96	108
36		437	507	574	657	983	1,066	1,148	1,230
48		472	529	624	719	1,058	1,153	1,248	1,343
60		459	811	918	1,025	1,133	1,240	1,348	1,699
72		484	848	968	1,088	1,452	1,572	1,692	1,811
84		509	886	1,018	1,150	1,527	1,659	1,791	2,168
96		534	923	1,068	1,213	1,602	1,746	1,891	2,280
108		559	960	1,118	1,275	1,676	1,834	1,991	2,392

FABRIC SHADES: Roman — Unlined

Chart pricing includes board mount or headrail mount. Sizes and series numbers beyond what is listed in the charts below are available—please submit these quote requests via fax or email. **NOTE: For headrail mount:** manual—maximum width 96"; motorized—maximum width 65". For larger widths, please order board mount shades.

HOBBLED (5" SPACING) & WATERFALL (7" SPACING) ROMAN SHADE

		Series 07							
		Overall Finished Width							
Length Up To		24	36	48	60	72	84	96	108
36		211	327	364	444	545	625	706	786
48		244	319	411	503	616	708	800	913
60		250	375	479	582	707	811	915	1,040
72		274	410	526	641	799	914	1,030	1,167
84		297	466	594	721	869	997	1,124	1,293
96		321	502	641	780	961	1,100	1,239	1,420
108		365	558	709	860	1,053	1,203	1,354	1,547

		Series 08							
		Overall Finished Width							
Length Up To		24	36	48	60	72	84	96	108
36		216	337	374	454	560	640	721	801
48		249	329	421	513	631	723	815	933
60		260	390	494	597	727	831	935	1,065
72		284	425	541	656	824	939	1,055	1,197
84		307	486	614	741	894	1,022	1,149	1,328
96		331	522	661	800	991	1,130	1,269	1,460
108		380	583	734	885	1,088	1,238	1,389	1,592

		Series 09							
		Overall Finished Width							
Length Up To		24	36	48	60	72	84	96	108
36		220	345	382	462	572	652	733	813
48		253	337	429	521	643	735	827	949
60		268	402	506	609	743	847	951	1,085
72		292	437	553	668	844	959	1,075	1,221
84		315	502	630	757	914	1,042	1,169	1,356
96		339	538	677	816	1,015	1,154	1,293	1,492
108		392	603	754	905	1,116	1,266	1,417	1,628

		Series 10							
		Overall Finished Width							
Length Up To		24	36	48	60	72	84	96	108
36		224	353	390	470	584	664	745	825
48		257	345	437	529	655	747	839	965
60		276	414	518	621	759	863	967	1,105
72		300	449	565	680	864	979	1,095	1,245
84		323	518	646	773	934	1,062	1,189	1,384
96		347	554	693	832	1,039	1,178	1,317	1,524
108		404	623	774	925	1,144	1,294	1,445	1,664

		Series 11							
		Overall Finished Width							
Length Up To		24	36	48	60	72	84	96	108
36		228	361	398	478	596	676	757	837
48		261	353	445	537	667	759	851	981
60		284	426	530	633	775	879	983	1,125
72		308	461	577	692	884	999	1,115	1,269
84		331	534	662	789	954	1,082	1,209	1,412
96		355	570	709	848	1,063	1,202	1,341	1,556
108		416	643	794	945	1,172	1,322	1,473	1,700

		Series 12							
		Overall Finished Width							
Length Up To		24	36	48	60	72	84	96	108
36		232	369	406	486	608	688	769	849
48		265	361	453	545	679	771	863	997
60		292	438	542	645	791	895	999	1,145
72		316	473	589	704	904	1,019	1,135	1,293
84		339	550	678	805	974	1,102	1,229	1,440
96		363	586	725	864	1,087	1,226	1,365	1,588
108		428	663	814	965	1,200	1,350	1,501	1,736

		Series 13							
		Overall Finished Width							
Length Up To		24	36	48	60	72	84	96	108
36		236	377	414	494	620	700	781	861
48		269	369	461	553	691	783	875	1,013
60		300	450	554	657	807	911	1,015	1,165
72		324	485	601	716	924	1,039	1,155	1,317
84		347	566	694	821	994	1,122	1,249	1,468
96		371	602	741	880	1,111	1,250	1,389	1,620
108		440	683	834	985	1,228	1,378	1,529	1,772

		Series 14							
		Overall Finished Width							
Length Up To		24	36	48	60	72	84	96	108
36		240	385	422	502	632	712	793	873
48		273	377	469	561	703	795	887	1,029
60		308	462	566	669	823	927	1,031	1,185
72		332	497	613	728	944	1,059	1,175	1,341
84		355	582	710	837	1,014	1,142	1,269	1,496
96		379	618	757	896	1,135	1,274	1,413	1,652
108		452	703	854	1,005	1,256	1,406	1,557	1,808

		Series 15							
		Overall Finished Width							
Length Up To		24	36	48	60	72	84	96	108
36		244	393	430	510	644	724	805	885
48		277	385	477	569	715	807	899	1,045
60		316	474	578	681	839	943	1,047	1,205
72		340	509	625	740	964	1,079	1,195	1,365
84		363	598	726	853	1,034	1,162	1,289	1,524
96		387	634	773	912	1,159	1,298	1,437	1,684
108		464	723	874	1,025	1,284	1,434	1,585	1,844

		Series 16							
		Overall Finished Width							
Length Up To		24	36	48	60	72	84	96	108
36		248	401	438	518	656	736	817	897
48		281	393	485	577	727	819	911	1,061
60		324	486	590	693	855	959	1,063	1,225
72		348	521	637	752	984	1,099	1,215	1,389
84		371	614	742	869	1,054	1,182	1,309	1,552
96		395	650	789	928	1,183	1,322	1,461	1,716
108		476	743	894	1,045	1,312	1,462	1,613	1,880

		Series 17							
		Overall Finished Width							
Length Up To		24	36	48	60	72	84	96	108
36		252	409	446	526	668	748	829	909
48		285	401	493	585	739	831	923	1,077
60		332	498	602	705	871	975	1,079	1,245
72		356	533	649	764	1,004	1,119	1,235	1,413
84		379	630	758	885	1,074	1,202	1,329	1,580
96		403	666	805	944	1,207	1,346	1,485	1,748
108		488	763	914	1,065	1,340	1,490	1,641	1,916

		Series 18							
		Overall Finished Width							
Length Up To		24	36	48	60	72	84	96	108
36		256	417	454	534	680	760	841	921
48		289	409	501	593	751	843	935	1,093
60		340	510	614	717	887	991	1,095	1,265
72		364	545	661	776	1,024	1,139	1,255	1,437
84		387	646	774	901	1,094	1,222	1,349	1,608
96		411	682	821	960	1,231	1,370	1,509	1,780
108		500	783	934	1,085	1,368	1,518	1,669	1,952

FABRIC SHADES: Roman — Unlined

Chart pricing includes board mount or headrail mount. Sizes and series numbers beyond what is listed in the charts below are available—please submit these quote requests via fax or email. **NOTE: For headrail mount:** manual—maximum width 96"; motorized—maximum width 65". For larger widths, please order board mount shades.

HOBBLED (5" SPACING) & WATERFALL (7" SPACING) ROMAN SHADE

		Series 19							
		Overall Finished Width							
Length Up To		24	36	48	60	72	84	96	108
36		260	425	462	542	692	772	853	933
48		293	417	509	601	763	855	947	1,109
60		348	522	626	729	903	1,007	1,111	1,285
72		372	557	673	788	1,044	1,159	1,275	1,461
84		395	662	790	917	1,114	1,242	1,369	1,636
96		419	698	837	976	1,255	1,394	1,533	1,812
108		512	803	954	1,105	1,396	1,546	1,697	1,988

		Series 20							
		Overall Finished Width							
Length Up To		24	36	48	60	72	84	96	108
36		264	433	470	550	704	784	865	945
48		297	425	517	609	775	867	959	1,125
60		356	534	638	741	919	1,023	1,127	1,305
72		380	569	685	800	1,064	1,179	1,295	1,485
84		403	678	806	933	1,134	1,262	1,389	1,664
96		427	714	853	992	1,279	1,418	1,557	1,844
108		524	823	974	1,125	1,424	1,574	1,725	2,024

		Series 21							
		Overall Finished Width							
Length Up To		24	36	48	60	72	84	96	108
36		268	441	478	558	716	796	877	957
48		301	433	525	617	787	879	971	1,141
60		364	546	650	753	935	1,039	1,143	1,325
72		388	581	697	812	1,084	1,199	1,315	1,509
84		411	694	822	949	1,154	1,282	1,409	1,692
96		435	730	869	1,008	1,303	1,442	1,581	1,876
108		536	843	994	1,145	1,452	1,602	1,753	2,060

		Series 22							
		Overall Finished Width							
Length Up To		24	36	48	60	72	84	96	108
36		272	449	486	566	728	808	889	969
48		305	441	533	625	799	891	983	1,157
60		372	558	662	765	951	1,055	1,159	1,345
72		396	593	709	824	1,104	1,219	1,335	1,533
84		419	710	838	965	1,174	1,302	1,429	1,720
96		443	746	885	1,024	1,327	1,466	1,605	1,908
108		548	863	1,014	1,165	1,480	1,630	1,781	2,096

		Series 23							
		Overall Finished Width							
Length Up To		24	36	48	60	72	84	96	108
36		276	457	494	574	740	820	901	981
48		309	449	541	633	811	903	995	1,173
60		380	570	674	777	967	1,071	1,175	1,365
72		404	605	721	836	1,124	1,239	1,355	1,557
84		427	726	854	981	1,194	1,322	1,449	1,748
96		451	762	901	1,040	1,351	1,490	1,629	1,940
108		560	883	1,034	1,185	1,508	1,658	1,809	2,132

		Series 24							
		Overall Finished Width							
Length Up To		24	36	48	60	72	84	96	108
36		280	465	502	582	752	832	913	993
48		313	457	549	641	823	915	1,007	1,189
60		388	582	686	789	983	1,087	1,191	1,385
72		412	617	733	848	1,144	1,259	1,375	1,581
84		435	742	870	997	1,214	1,342	1,469	1,776
96		459	778	917	1,056	1,375	1,514	1,653	1,972
108		572	903	1,054	1,205	1,536	1,686	1,837	2,168

		Series 25							
		Overall Finished Width							
Length Up To		24	36	48	60	72	84	96	108
36		286	477	514	594	770	850	931	1,011
48		319	469	561	653	841	933	1,025	1,213
60		400	600	704	807	1,007	1,111	1,215	1,415
72		424	635	751	866	1,174	1,289	1,405	1,617
84		447	766	894	1,021	1,244	1,372	1,499	1,818
96		471	802	941	1,080	1,411	1,550	1,689	2,020
108		590	933	1,084	1,235	1,578	1,728	1,879	2,222

		Series 26							
		Overall Finished Width							
Length Up To		24	36	48	60	72	84	96	108
36		290	485	522	602	782	862	943	1,023
48		323	477	569	661	853	945	1,037	1,229
60		408	612	716	819	1,023	1,127	1,231	1,435
72		432	647	763	878	1,194	1,309	1,425	1,641
84		455	782	910	1,037	1,264	1,392	1,519	1,846
96		479	818	957	1,096	1,435	1,574	1,713	2,052
108		602	953	1,104	1,255	1,606	1,756	1,907	2,258

		Series 27							
		Overall Finished Width							
Length Up To		24	36	48	60	72	84	96	108
36		294	493	530	610	794	874	955	1,035
48		327	485	577	669	865	957	1,049	1,245
60		416	624	728	831	1,039	1,143	1,247	1,455
72		440	659	775	890	1,214	1,329	1,445	1,665
84		463	798	926	1,053	1,284	1,412	1,539	1,874
96		487	834	973	1,112	1,459	1,598	1,737	2,084
108		614	973	1,124	1,275	1,634	1,784	1,935	2,294

		Series 28							
		Overall Finished Width							
Length Up To		24	36	48	60	72	84	96	108
36		298	501	538	618	806	886	967	1,047
48		331	493	585	677	877	969	1,061	1,261
60		424	636	740	843	1,055	1,159	1,263	1,475
72		448	671	787	902	1,234	1,349	1,465	1,689
84		471	814	942	1,069	1,304	1,432	1,559	1,902
96		495	850	989	1,128	1,483	1,622	1,761	2,116
108		626	993	1,144	1,295	1,662	1,812	1,963	2,330

		Series 29							
		Overall Finished Width							
Length Up To		24	36	48	60	72	84	96	108
36		302	509	546	626	818	898	979	1,059
48		335	501	593	685	889	981	1,073	1,277
60		432	648	752	855	1,071	1,175	1,279	1,495
72		456	683	799	914	1,254	1,369	1,485	1,713
84		479	830	958	1,085	1,324	1,452	1,579	1,930
96		503	866	1,005	1,144	1,507	1,646	1,785	2,148
108		638	1,013	1,164	1,315	1,690	1,840	1,991	2,366

		Series 30							
		Overall Finished Width							
Length Up To		24	36	48	60	72	84	96	108
36		308	521	558	638	836	916	997	1,077
48		341	513	605	697	907	999	1,091	1,301
60		444	666	770	873	1,095	1,199	1,303	1,525
72		468	701	817	932	1,284	1,399	1,515	1,749
84		491	854	982	1,109	1,354	1,482	1,609	1,972
96		515	890	1,029	1,168	1,543	1,682	1,821	2,196
108		656	1,043	1,194	1,345	1,732	1,882	2,033	2,420

FABRIC SHADES: Roman — Unlined

Chart pricing includes board mount or headrail mount. Sizes and series numbers beyond what is listed in the charts below are available—please submit these quote requests via fax or email. **NOTE: For headrail mount:** manual—maximum width 96"; motorized—maximum width 65". For larger widths, please order board mount shades.

HOBBLED (5" SPACING) & WATERFALL (7" SPACING) ROMAN SHADE

		Series 31							
		Overall Finished Width							
Length	Up To	24	36	48	60	72	84	96	108
36		311	527	564	644	845	925	1,006	1,086
48		344	519	611	703	916	1,008	1,100	1,313
60		450	675	779	882	1,107	1,211	1,315	1,540
72		474	710	826	941	1,299	1,414	1,530	1,767
84		497	866	994	1,121	1,369	1,497	1,624	1,993
96		521	902	1,041	1,180	1,561	1,700	1,839	2,220
108		665	1,058	1,209	1,360	1,753	1,903	2,054	2,447

		Series 32							
		Overall Finished Width							
Length	Up To	24	36	48	60	72	84	96	108
36		315	535	572	652	857	937	1,018	1,098
48		348	527	619	711	928	1,020	1,112	1,329
60		458	687	791	894	1,123	1,227	1,331	1,560
72		482	722	838	953	1,319	1,434	1,550	1,791
84		505	882	1,010	1,137	1,389	1,517	1,644	2,021
96		529	918	1,057	1,196	1,585	1,724	1,863	2,252
108		677	1,078	1,229	1,380	1,781	1,931	2,082	2,483

		Series 33							
		Overall Finished Width							
Length	Up To	24	36	48	60	72	84	96	108
36		320	545	582	662	872	952	1,033	1,113
48		353	537	629	721	943	1,035	1,127	1,349
60		468	702	806	909	1,143	1,247	1,351	1,585
72		492	737	853	968	1,344	1,459	1,575	1,821
84		515	902	1,030	1,157	1,414	1,542	1,669	2,056
96		539	938	1,077	1,216	1,615	1,754	1,893	2,292
108		692	1,103	1,254	1,405	1,816	1,966	2,117	2,528

		Series 34							
		Overall Finished Width							
Length	Up To	24	36	48	60	72	84	96	108
36		330	565	602	682	902	982	1,063	1,143
48		363	557	649	741	973	1,065	1,157	1,389
60		488	732	836	939	1,183	1,287	1,391	1,635
72		512	767	883	998	1,394	1,509	1,625	1,881
84		535	942	1,070	1,197	1,464	1,592	1,719	2,126
96		559	978	1,117	1,256	1,675	1,814	1,953	2,372
108		722	1,153	1,304	1,455	1,886	2,036	2,187	2,618

		Series 35							
		Overall Finished Width							
Length	Up To	24	36	48	60	72	84	96	108
36		340	585	622	702	932	1,012	1,093	1,173
48		373	577	669	761	1,003	1,095	1,187	1,429
60		508	762	866	969	1,223	1,327	1,431	1,685
72		532	797	913	1,028	1,444	1,559	1,675	1,941
84		555	982	1,110	1,237	1,514	1,642	1,769	2,196
96		579	1,018	1,157	1,296	1,735	1,874	2,013	2,452
108		752	1,203	1,354	1,505	1,956	2,106	2,257	2,708

		Series 36							
		Overall Finished Width							
Length	Up To	24	36	48	60	72	84	96	108
36		352	609	646	726	968	1,048	1,129	1,209
48		385	601	693	785	1,039	1,131	1,223	1,477
60		532	798	902	1,005	1,271	1,375	1,479	1,745
72		556	833	949	1,064	1,504	1,619	1,735	2,013
84		579	1,030	1,158	1,285	1,574	1,702	1,829	2,280
96		603	1,066	1,205	1,344	1,807	1,946	2,085	2,548
108		788	1,263	1,414	1,565	2,040	2,190	2,341	2,816

		Series 37							
		Overall Finished Width							
Length	Up To	24	36	48	60	72	84	96	108
36		370	645	682	762	1,022	1,102	1,183	1,263
48		403	637	729	821	1,093	1,185	1,277	1,549
60		568	852	956	1,059	1,343	1,447	1,551	1,835
72		592	887	1,003	1,118	1,594	1,709	1,825	2,121
84		615	1,102	1,230	1,357	1,664	1,792	1,919	2,406
96		639	1,138	1,277	1,416	1,915	2,054	2,193	2,692
108		842	1,353	1,504	1,655	2,166	2,316	2,467	2,978

		Series 38							
		Overall Finished Width							
Length	Up To	24	36	48	60	72	84	96	108
36		410	725	762	842	1,142	1,222	1,303	1,383
48		443	717	809	901	1,213	1,305	1,397	1,709
60		648	972	1,076	1,179	1,503	1,607	1,711	2,035
72		672	1,007	1,123	1,238	1,794	1,909	2,025	2,361
84		695	1,262	1,390	1,517	1,864	1,992	2,119	2,686
96		719	1,298	1,437	1,576	2,155	2,294	2,433	3,012
108		962	1,553	1,704	1,855	2,446	2,596	2,747	3,338

FABRIC SHADES: Roman — Lined (Lining 01000)

Chart pricing includes board mount or headrail mount. Sizes and series numbers beyond what is listed in the charts below are available—please submit these quote requests via fax or email. **NOTE: For headrail mount:** manual—maximum width 82"; motorized—maximum width 55". For larger widths, please order board mount shades.

HOBBLED (5" SPACING) & WATERFALL (7" SPACING) ROMAN SHADE

		Series 07							
Length		Overall Finished Width							
Up To		24	36	48	60	72	84	96	108
36		238	380	420	503	630	713	795	877
48		273	375	470	565	705	800	895	1,035
60		305	458	565	672	825	932	1,040	1,192
72		330	495	615	735	945	1,065	1,185	1,349
84		355	578	710	842	1,020	1,152	1,284	1,507
96		380	615	760	905	1,140	1,284	1,429	1,664
108		450	697	855	1,012	1,259	1,417	1,574	1,821

		Series 08							
Length		Overall Finished Width							
Up To		24	36	48	60	72	84	96	108
36		243	390	430	513	645	728	810	892
48		278	385	480	575	720	815	910	1,055
60		315	473	580	687	845	952	1,060	1,217
72		340	510	630	750	970	1,090	1,210	1,379
84		365	598	730	862	1,045	1,177	1,309	1,542
96		390	635	780	925	1,170	1,314	1,459	1,704
108		465	722	880	1,037	1,294	1,452	1,609	1,866

		Series 09							
Length		Overall Finished Width							
Up To		24	36	48	60	72	84	96	108
36		247	398	438	521	657	740	822	904
48		282	393	488	583	732	827	922	1,071
60		323	485	592	699	861	968	1,076	1,237
72		348	522	642	762	990	1,110	1,230	1,403
84		373	614	746	878	1,065	1,197	1,329	1,570
96		398	651	796	941	1,194	1,338	1,483	1,736
108		477	742	900	1,057	1,322	1,480	1,637	1,902

		Series 10							
Length		Overall Finished Width							
Up To		24	36	48	60	72	84	96	108
36		251	406	446	529	669	752	834	916
48		286	401	496	591	744	839	934	1,087
60		331	497	604	711	877	984	1,092	1,257
72		356	534	654	774	1,010	1,130	1,250	1,427
84		381	630	762	894	1,085	1,217	1,349	1,598
96		406	667	812	957	1,218	1,362	1,507	1,768
108		489	762	920	1,077	1,350	1,508	1,665	1,938

		Series 11							
Length		Overall Finished Width							
Up To		24	36	48	60	72	84	96	108
36		255	414	454	537	681	764	846	928
48		290	409	504	599	756	851	946	1,103
60		339	509	616	723	893	1,000	1,108	1,277
72		364	546	666	786	1,030	1,150	1,270	1,451
84		389	646	778	910	1,105	1,237	1,369	1,626
96		414	683	828	973	1,242	1,386	1,531	1,800
108		501	782	940	1,097	1,378	1,536	1,693	1,974

		Series 12							
Length		Overall Finished Width							
Up To		24	36	48	60	72	84	96	108
36		259	422	462	545	693	776	858	940
48		294	417	512	607	768	863	958	1,119
60		347	521	628	735	909	1,016	1,124	1,297
72		372	558	678	798	1,050	1,170	1,290	1,475
84		397	662	794	926	1,125	1,257	1,389	1,654
96		422	699	844	989	1,266	1,410	1,555	1,832
108		513	802	960	1,117	1,406	1,564	1,721	2,010

		Series 13							
Length		Overall Finished Width							
Up To		24	36	48	60	72	84	96	108
36		263	430	470	553	705	788	870	952
48		298	425	520	615	780	875	970	1,135
60		355	533	640	747	925	1,032	1,140	1,317
72		380	570	690	810	1,070	1,190	1,310	1,499
84		405	678	810	942	1,145	1,277	1,409	1,682
96		430	715	860	1,005	1,290	1,434	1,579	1,864
108		525	822	980	1,137	1,434	1,592	1,749	2,046

		Series 14							
Length		Overall Finished Width							
Up To		24	36	48	60	72	84	96	108
36		267	438	478	561	717	800	882	964
48		302	433	528	623	792	887	982	1,151
60		363	545	652	759	941	1,048	1,156	1,337
72		388	582	702	822	1,090	1,210	1,330	1,523
84		413	694	826	958	1,165	1,297	1,429	1,710
96		438	731	876	1,021	1,314	1,458	1,603	1,896
108		537	842	1,000	1,157	1,462	1,620	1,777	2,082

		Series 15							
Length		Overall Finished Width							
Up To		24	36	48	60	72	84	96	108
36		271	446	486	569	729	812	894	976
48		306	441	536	631	804	899	994	1,167
60		371	557	664	771	957	1,064	1,172	1,357
72		396	594	714	834	1,110	1,230	1,350	1,547
84		421	710	842	974	1,185	1,317	1,449	1,738
96		446	747	892	1,037	1,338	1,482	1,627	1,928
108		549	862	1,020	1,177	1,490	1,648	1,805	2,118

		Series 16							
Length		Overall Finished Width							
Up To		24	36	48	60	72	84	96	108
36		275	454	494	577	741	824	906	988
48		310	449	544	639	816	911	1,006	1,183
60		379	569	676	783	973	1,080	1,188	1,377
72		404	606	726	846	1,130	1,250	1,370	1,571
84		429	726	858	990	1,205	1,337	1,469	1,766
96		454	763	908	1,053	1,362	1,506	1,651	1,960
108		561	882	1,040	1,197	1,518	1,676	1,833	2,154

		Series 17							
Length		Overall Finished Width							
Up To		24	36	48	60	72	84	96	108
36		279	462	502	585	753	836	918	1,000
48		314	457	552	647	828	923	1,018	1,199
60		387	581	688	795	989	1,096	1,204	1,397
72		412	618	738	858	1,150	1,270	1,390	1,595
84		437	742	874	1,006	1,225	1,357	1,489	1,794
96		462	779	924	1,069	1,386	1,530	1,675	1,992
108		573	902	1,060	1,217	1,546	1,704	1,861	2,190

		Series 18							
Length		Overall Finished Width							
Up To		24	36	48	60	72	84	96	108
36		283	470	510	593	765	848	930	1,012
48		318	465	560	655	840	935	1,030	1,215
60		395	593	700	807	1,005	1,112	1,220	1,417
72		420	630	750	870	1,170	1,290	1,410	1,619
84		445	758	890	1,022	1,245	1,377	1,509	1,822
96		470	795	940	1,085	1,410	1,554	1,699	2,024
108		585	922	1,080	1,237	1,574	1,732	1,889	2,226

FABRIC SHADES: Roman — Lined (Lining 01000)

Chart pricing includes board mount or headrail mount. Sizes and series numbers beyond what is listed in the charts below are available—please submit these quote requests via fax or email. **NOTE: For headrail mount:** manual—maximum width 82"; motorized—maximum width 55". For larger widths, please order board mount shades.

HOBBLED (5" SPACING) & WATERFALL (7" SPACING) ROMAN SHADE

		Series 19							
		Overall Finished Width							
Length Up To		24	36	48	60	72	84	96	108
36		287	478	518	601	777	860	942	1,024
48		322	473	568	663	852	947	1,042	1,231
60		403	605	712	819	1,021	1,128	1,236	1,437
72		428	642	762	882	1,190	1,310	1,430	1,643
84		453	774	906	1,038	1,265	1,397	1,529	1,850
96		478	811	956	1,101	1,434	1,578	1,723	2,056
108		597	942	1,100	1,257	1,602	1,760	1,917	2,262

		Series 20							
		Overall Finished Width							
Length Up To		24	36	48	60	72	84	96	108
36		291	486	526	609	789	872	954	1,036
48		326	481	576	671	864	959	1,054	1,247
60		411	617	724	831	1,037	1,144	1,252	1,457
72		436	654	774	894	1,210	1,330	1,450	1,667
84		461	790	922	1,054	1,285	1,417	1,549	1,878
96		486	827	972	1,117	1,458	1,602	1,747	2,088
108		609	962	1,120	1,277	1,630	1,788	1,945	2,298

		Series 21							
		Overall Finished Width							
Length Up To		24	36	48	60	72	84	96	108
36		295	494	534	617	801	884	966	1,048
48		330	489	584	679	876	971	1,066	1,263
60		419	629	736	843	1,053	1,160	1,268	1,477
72		444	666	786	906	1,230	1,350	1,470	1,691
84		469	806	938	1,070	1,305	1,437	1,569	1,906
96		494	843	988	1,133	1,482	1,626	1,771	2,120
108		621	982	1,140	1,297	1,658	1,816	1,973	2,334

		Series 22							
		Overall Finished Width							
Length Up To		24	36	48	60	72	84	96	108
36		299	502	542	625	813	896	978	1,060
48		334	497	592	687	888	983	1,078	1,279
60		427	641	748	855	1,069	1,176	1,284	1,497
72		452	678	798	918	1,250	1,370	1,490	1,715
84		477	822	954	1,086	1,325	1,457	1,589	1,934
96		502	859	1,004	1,149	1,506	1,650	1,795	2,152
108		633	1,002	1,160	1,317	1,686	1,844	2,001	2,370

		Series 23							
		Overall Finished Width							
Length Up To		24	36	48	60	72	84	96	108
36		303	510	550	633	825	908	990	1,072
48		338	505	600	695	900	995	1,090	1,295
60		435	653	760	867	1,085	1,192	1,300	1,517
72		460	690	810	930	1,270	1,390	1,510	1,739
84		485	838	970	1,102	1,345	1,477	1,609	1,962
96		510	875	1,020	1,165	1,530	1,674	1,819	2,184
108		645	1,022	1,180	1,337	1,714	1,872	2,029	2,406

		Series 24							
		Overall Finished Width							
Length Up To		24	36	48	60	72	84	96	108
36		307	518	558	641	837	920	1,002	1,084
48		342	513	608	703	912	1,007	1,102	1,311
60		443	665	772	879	1,101	1,208	1,316	1,537
72		468	702	822	942	1,290	1,410	1,530	1,763
84		493	854	986	1,118	1,365	1,497	1,629	1,990
96		518	891	1,036	1,181	1,554	1,698	1,843	2,216
108		657	1,042	1,200	1,357	1,742	1,900	2,057	2,442

		Series 25							
		Overall Finished Width							
Length Up To		24	36	48	60	72	84	96	108
36		313	530	570	653	855	938	1,020	1,102
48		348	525	620	715	930	1,025	1,120	1,335
60		455	683	790	897	1,125	1,232	1,340	1,567
72		480	720	840	960	1,320	1,440	1,560	1,799
84		505	878	1,010	1,142	1,395	1,527	1,659	2,032
96		530	915	1,060	1,205	1,590	1,734	1,879	2,264
108		675	1,072	1,230	1,387	1,784	1,942	2,099	2,496

		Series 26							
		Overall Finished Width							
Length Up To		24	36	48	60	72	84	96	108
36		317	538	578	661	867	950	1,032	1,114
48		352	533	628	723	942	1,037	1,132	1,351
60		463	695	802	909	1,141	1,248	1,356	1,587
72		488	732	852	972	1,340	1,460	1,580	1,823
84		513	894	1,026	1,158	1,415	1,547	1,679	2,060
96		538	931	1,076	1,221	1,614	1,758	1,903	2,296
108		687	1,092	1,250	1,407	1,812	1,970	2,127	2,532

		Series 27							
		Overall Finished Width							
Length Up To		24	36	48	60	72	84	96	108
36		321	546	586	669	879	962	1,044	1,126
48		356	541	636	731	954	1,049	1,144	1,367
60		471	707	814	921	1,157	1,264	1,372	1,607
72		496	744	864	984	1,360	1,480	1,600	1,847
84		521	910	1,042	1,174	1,435	1,567	1,699	2,088
96		546	947	1,092	1,237	1,638	1,782	1,927	2,328
108		699	1,112	1,270	1,427	1,840	1,998	2,155	2,568

		Series 28							
		Overall Finished Width							
Length Up To		24	36	48	60	72	84	96	108
36		325	554	594	677	891	974	1,056	1,138
48		360	549	644	739	966	1,061	1,156	1,383
60		479	719	826	933	1,173	1,280	1,388	1,627
72		504	756	876	996	1,380	1,500	1,620	1,871
84		529	926	1,058	1,190	1,455	1,587	1,719	2,116
96		554	963	1,108	1,253	1,662	1,806	1,951	2,360
108		711	1,132	1,290	1,447	1,868	2,026	2,183	2,604

		Series 29							
		Overall Finished Width							
Length Up To		24	36	48	60	72	84	96	108
36		329	562	602	685	903	986	1,068	1,150
48		364	557	652	747	978	1,073	1,168	1,399
60		487	731	838	945	1,189	1,296	1,404	1,647
72		512	768	888	1,008	1,400	1,520	1,640	1,895
84		537	942	1,074	1,206	1,475	1,607	1,739	2,144
96		562	979	1,124	1,269	1,686	1,830	1,975	2,392
108		723	1,152	1,310	1,467	1,896	2,054	2,211	2,640

		Series 30							
		Overall Finished Width							
Length Up To		24	36	48	60	72	84	96	108
36		335	574	614	697	921	1,004	1,086	1,168
48		370	569	664	759	996	1,091	1,186	1,423
60		499	749	856	963	1,213	1,320	1,428	1,677
72		524	786	906	1,026	1,430	1,550	1,670	1,931
84		549	966	1,098	1,230	1,505	1,637	1,769	2,186
96		574	1,003	1,148	1,293	1,722	1,866	2,011	2,440
108		741	1,182	1,340	1,497	1,938	2,096	2,253	2,694

FABRIC SHADES: Roman — Lined (Lining 01000)

Chart pricing includes board mount or headrail mount. Sizes and series numbers beyond what is listed in the charts below are available—please submit these quote requests via fax or email. **NOTE: For headrail mount:** manual—maximum width 82"; motorized—maximum width 55". For larger widths, please order board mount shades.

HOBBLED (5" SPACING) & WATERFALL (7" SPACING) ROMAN SHADE

		Series 31							
		Overall Finished Width							
Length Up To		24	36	48	60	72	84	96	108
36		338	580	620	703	930	1,013	1,095	1,177
48		373	575	670	765	1,005	1,100	1,195	1,435
60		505	758	865	972	1,225	1,332	1,440	1,692
72		530	795	915	1,035	1,445	1,565	1,685	1,949
84		555	978	1,110	1,242	1,520	1,652	1,784	2,207
96		580	1,015	1,160	1,305	1,740	1,884	2,029	2,464
108		750	1,197	1,355	1,512	1,959	2,117	2,274	2,721

		Series 32							
		Overall Finished Width							
Length Up To		24	36	48	60	72	84	96	108
36		342	588	628	711	942	1,025	1,107	1,189
48		377	583	678	773	1,017	1,112	1,207	1,451
60		513	770	877	984	1,241	1,348	1,456	1,712
72		538	807	927	1,047	1,465	1,585	1,705	1,973
84		563	994	1,126	1,258	1,540	1,672	1,804	2,235
96		588	1,031	1,176	1,321	1,764	1,908	2,053	2,496
108		762	1,217	1,375	1,532	1,987	2,145	2,302	2,757

		Series 33							
		Overall Finished Width							
Length Up To		24	36	48	60	72	84	96	108
36		347	598	638	721	957	1,040	1,122	1,204
48		382	593	688	783	1,032	1,127	1,222	1,471
60		523	785	892	999	1,261	1,368	1,476	1,737
72		548	822	942	1,062	1,490	1,610	1,730	2,003
84		573	1,014	1,146	1,278	1,565	1,697	1,829	2,270
96		598	1,051	1,196	1,341	1,794	1,938	2,083	2,536
108		777	1,242	1,400	1,557	2,022	2,180	2,337	2,802

		Series 34							
		Overall Finished Width							
Length Up To		24	36	48	60	72	84	96	108
36		357	618	658	741	987	1,070	1,152	1,234
48		392	613	708	803	1,062	1,157	1,252	1,511
60		543	815	922	1,029	1,301	1,408	1,516	1,787
72		568	852	972	1,092	1,540	1,660	1,780	2,063
84		593	1,054	1,186	1,318	1,615	1,747	1,879	2,340
96		618	1,091	1,236	1,381	1,854	1,998	2,143	2,616
108		807	1,292	1,450	1,607	2,092	2,250	2,407	2,892

		Series 35							
		Overall Finished Width							
Length Up To		24	36	48	60	72	84	96	108
36		367	638	678	761	1,017	1,100	1,182	1,264
48		402	633	728	823	1,092	1,187	1,282	1,551
60		563	845	952	1,059	1,341	1,448	1,556	1,837
72		588	882	1,002	1,122	1,590	1,710	1,830	2,123
84		613	1,094	1,226	1,358	1,665	1,797	1,929	2,410
96		638	1,131	1,276	1,421	1,914	2,058	2,203	2,696
108		837	1,342	1,500	1,657	2,162	2,320	2,477	2,982

		Series 36							
		Overall Finished Width							
Length Up To		24	36	48	60	72	84	96	108
36		379	662	702	785	1,053	1,136	1,218	1,300
48		414	657	752	847	1,128	1,223	1,318	1,599
60		587	881	988	1,095	1,389	1,496	1,604	1,897
72		612	918	1,038	1,158	1,650	1,770	1,890	2,195
84		637	1,142	1,274	1,406	1,725	1,857	1,989	2,494
96		662	1,179	1,324	1,469	1,986	2,130	2,275	2,792
108		873	1,402	1,560	1,717	2,246	2,404	2,561	3,090

		Series 37							
		Overall Finished Width							
Length Up To		24	36	48	60	72	84	96	108
36		397	698	738	821	1,107	1,190	1,272	1,354
48		432	693	788	883	1,182	1,277	1,372	1,671
60		623	935	1,042	1,149	1,461	1,568	1,676	1,987
72		648	972	1,092	1,212	1,740	1,860	1,980	2,303
84		673	1,214	1,346	1,478	1,815	1,947	2,079	2,620
96		698	1,251	1,396	1,541	2,094	2,238	2,383	2,936
108		927	1,492	1,650	1,807	2,372	2,530	2,687	3,252

		Series 38							
		Overall Finished Width							
Length Up To		24	36	48	60	72	84	96	108
36		437	778	818	901	1,227	1,310	1,392	1,474
48		472	773	868	963	1,302	1,397	1,492	1,831
60		703	1,055	1,162	1,269	1,621	1,728	1,836	2,187
72		728	1,092	1,212	1,332	1,940	2,060	2,180	2,543
84		753	1,374	1,506	1,638	2,015	2,147	2,279	2,900
96		778	1,411	1,556	1,701	2,334	2,478	2,623	3,256
108		1,047	1,692	1,850	2,007	2,652	2,810	2,967	3,612

FABRIC SHADES: Roman — Unlined

Chart pricing includes board mount or headrail mount. Sizes and series numbers beyond what is listed in the charts below are available—please submit these quote requests via fax or email. **NOTE: For headrail mount:** manual—maximum width 139"; motorized—maximum width 94". For larger widths, please order board mount shades.

RELAXED & SLOUCH ROMAN SHADE

		Series 07							
		Overall Finished Width							
Length Up To		24	36	48	60	72	84	96	108
36		194	271	339	413	487	562	636	731
48		221	294	378	462	567	651	735	818
60		209	323	417	510	625	719	812	927
72		228	352	456	559	683	787	890	1,014
84		269	403	516	629	763	876	989	1,123
96		288	432	555	677	821	944	1,067	1,210
108		307	461	593	726	879	1,012	1,144	1,298

		Series 08							
		Overall Finished Width							
Length Up To		24	36	48	60	72	84	96	108
36		199	280	349	423	497	572	646	746
48		226	304	388	472	582	666	750	833
60		214	333	427	520	640	734	827	947
72		233	362	466	569	698	802	905	1,034
84		279	418	531	644	783	896	1,009	1,148
96		298	447	570	692	841	964	1,087	1,235
108		317	476	608	741	899	1,032	1,164	1,323

		Series 09							
		Overall Finished Width							
Length Up To		24	36	48	60	72	84	96	108
36		203	287	357	431	505	580	654	758
48		230	312	396	480	594	678	762	845
60		218	341	435	528	652	746	839	963
72		237	370	474	577	710	814	917	1,050
84		287	430	543	656	799	912	1,025	1,168
96		306	459	582	704	857	980	1,103	1,255
108		325	488	620	753	915	1,048	1,180	1,343

		Series 10							
		Overall Finished Width							
Length Up To		24	36	48	60	72	84	96	108
36		207	294	365	439	513	588	662	770
48		234	320	404	488	606	690	774	857
60		222	349	443	536	664	758	851	979
72		241	378	482	585	722	826	929	1,066
84		295	442	555	668	815	928	1,041	1,188
96		314	471	594	716	873	996	1,119	1,275
108		333	500	632	765	931	1,064	1,196	1,363

		Series 11							
		Overall Finished Width							
Length Up To		24	36	48	60	72	84	96	108
36		211	302	373	447	521	596	670	782
48		238	328	412	496	618	702	786	869
60		226	357	451	544	676	770	863	995
72		245	386	490	593	734	838	941	1,082
84		303	454	567	680	831	944	1,057	1,208
96		322	483	606	728	889	1,012	1,135	1,295
108		341	512	644	777	947	1,080	1,212	1,383

		Series 12							
		Overall Finished Width							
Length Up To		24	36	48	60	72	84	96	108
36		215	309	381	455	529	604	678	794
48		242	336	420	504	630	714	798	881
60		230	365	459	552	688	782	875	1,011
72		249	394	498	601	746	850	953	1,098
84		311	466	579	692	847	960	1,073	1,228
96		330	495	618	740	905	1,028	1,151	1,315
108		349	524	656	789	963	1,096	1,228	1,403

		Series 13							
		Overall Finished Width							
Length Up To		24	36	48	60	72	84	96	108
36		219	316	389	463	537	612	686	806
48		246	344	428	512	642	726	810	893
60		234	373	467	560	700	794	887	1,027
72		253	402	506	609	758	862	965	1,114
84		319	478	591	704	863	976	1,089	1,248
96		338	507	630	752	921	1,044	1,167	1,335
108		357	536	668	801	979	1,112	1,244	1,423

		Series 14							
		Overall Finished Width							
Length Up To		24	36	48	60	72	84	96	108
36		223	323	397	471	545	620	694	818
48		250	352	436	520	654	738	822	905
60		238	381	475	568	712	806	899	1,043
72		257	410	514	617	770	874	977	1,130
84		327	490	603	716	879	992	1,105	1,268
96		346	519	642	764	937	1,060	1,183	1,355
108		365	548	680	813	995	1,128	1,260	1,443

		Series 15							
		Overall Finished Width							
Length Up To		24	36	48	60	72	84	96	108
36		227	330	405	479	553	628	702	830
48		254	360	444	528	666	750	834	917
60		242	389	483	576	724	818	911	1,059
72		261	418	522	625	782	886	989	1,146
84		335	502	615	728	895	1,008	1,121	1,288
96		354	531	654	776	953	1,076	1,199	1,375
108		373	560	692	825	1,011	1,144	1,276	1,463

		Series 16							
		Overall Finished Width							
Length Up To		24	36	48	60	72	84	96	108
36		231	338	413	487	561	636	710	842
48		258	368	452	536	678	762	846	929
60		246	397	491	584	736	830	923	1,075
72		265	426	530	633	794	898	1,001	1,162
84		343	514	627	740	911	1,024	1,137	1,308
96		362	543	666	788	969	1,092	1,215	1,395
108		381	572	704	837	1,027	1,160	1,292	1,483

		Series 17							
		Overall Finished Width							
Length Up To		24	36	48	60	72	84	96	108
36		235	345	421	495	569	644	718	854
48		262	376	460	544	690	774	858	941
60		250	405	499	592	748	842	935	1,091
72		269	434	538	641	806	910	1,013	1,178
84		351	526	639	752	927	1,040	1,153	1,328
96		370	555	678	800	985	1,108	1,231	1,415
108		389	584	716	849	1,043	1,176	1,308	1,503

		Series 18							
		Overall Finished Width							
Length Up To		24	36	48	60	72	84	96	108
36		239	352	429	503	577	652	726	866
48		266	384	468	552	702	786	870	953
60		254	413	507	600	760	854	947	1,107
72		273	442	546	649	818	922	1,025	1,194
84		359	538	651	764	943	1,056	1,169	1,348
96		378	567	690	812	1,001	1,124	1,247	1,435
108		397	596	728	861	1,059	1,192	1,324	1,523

NOTE: For relaxed and slouch style shades, please specify the length option: to the bottom of the scallop, to the bottom of the weight bar OR straight bottom

FABRIC SHADES: Roman — Unlined

Chart pricing includes board mount or headrail mount. Sizes and series numbers beyond what is listed in the charts below are available—please submit these quote requests via fax or email. **NOTE: For headrail mount:** manual—maximum width 139"; motorized—maximum width 94". For larger widths, please order board mount shades.

RELAXED & SLOUCH ROMAN SHADE

		Series 19							
Length		Overall Finished Width							
Up To		24	36	48	60	72	84	96	108
36		243	359	437	511	585	660	734	878
48		270	392	476	560	714	798	882	965
60		258	421	515	608	772	866	959	1,123
72		277	450	554	657	830	934	1,037	1,210
84		367	550	663	776	959	1,072	1,185	1,368
96		386	579	702	824	1,017	1,140	1,263	1,455
108		405	608	740	873	1,075	1,208	1,340	1,543

		Series 20							
Length		Overall Finished Width							
Up To		24	36	48	60	72	84	96	108
36		247	366	445	519	593	668	742	890
48		274	400	484	568	726	810	894	977
60		262	429	523	616	784	878	971	1,139
72		281	458	562	665	842	946	1,049	1,226
84		375	562	675	788	975	1,088	1,201	1,388
96		394	591	714	836	1,033	1,156	1,279	1,475
108		413	620	752	885	1,091	1,224	1,356	1,563

		Series 21							
Length		Overall Finished Width							
Up To		24	36	48	60	72	84	96	108
36		251	374	453	527	601	676	750	902
48		278	408	492	576	738	822	906	989
60		266	437	531	624	796	890	983	1,155
72		285	466	570	673	854	958	1,061	1,242
84		383	574	687	800	991	1,104	1,217	1,408
96		402	603	726	848	1,049	1,172	1,295	1,495
108		421	632	764	897	1,107	1,240	1,372	1,583

		Series 22							
Length		Overall Finished Width							
Up To		24	36	48	60	72	84	96	108
36		255	381	461	535	609	684	758	914
48		282	416	500	584	750	834	918	1,001
60		270	445	539	632	808	902	995	1,171
72		289	474	578	681	866	970	1,073	1,258
84		391	586	699	812	1,007	1,120	1,233	1,428
96		410	615	738	860	1,065	1,188	1,311	1,515
108		429	644	776	909	1,123	1,256	1,388	1,603

		Series 23							
Length		Overall Finished Width							
Up To		24	36	48	60	72	84	96	108
36		259	388	469	543	617	692	766	926
48		286	424	508	592	762	846	930	1,013
60		274	453	547	640	820	914	1,007	1,187
72		293	482	586	689	878	982	1,085	1,274
84		399	598	711	824	1,023	1,136	1,249	1,448
96		418	627	750	872	1,081	1,204	1,327	1,535
108		437	656	788	921	1,139	1,272	1,404	1,623

		Series 24							
Length		Overall Finished Width							
Up To		24	36	48	60	72	84	96	108
36		263	395	477	551	625	700	774	938
48		290	432	516	600	774	858	942	1,025
60		278	461	555	648	832	926	1,019	1,203
72		297	490	594	697	890	994	1,097	1,290
84		407	610	723	836	1,039	1,152	1,265	1,468
96		426	639	762	884	1,097	1,220	1,343	1,555
108		445	668	800	933	1,155	1,288	1,420	1,643

		Series 25							
Length		Overall Finished Width							
Up To		24	36	48	60	72	84	96	108
36		269	406	489	563	637	712	786	956
48		296	444	528	612	792	876	960	1,043
60		284	473	567	660	850	944	1,037	1,227
72		303	502	606	709	908	1,012	1,115	1,314
84		419	628	741	854	1,063	1,176	1,289	1,498
96		438	657	780	902	1,121	1,244	1,367	1,585
108		457	686	818	951	1,179	1,312	1,444	1,673

		Series 26							
Length		Overall Finished Width							
Up To		24	36	48	60	72	84	96	108
36		273	413	497	571	645	720	794	968
48		300	452	536	620	804	888	972	1,055
60		288	481	575	668	862	956	1,049	1,243
72		307	510	614	717	920	1,024	1,127	1,330
84		427	640	753	866	1,079	1,192	1,305	1,518
96		446	669	792	914	1,137	1,260	1,383	1,605
108		465	698	830	963	1,195	1,328	1,460	1,693

		Series 27							
Length		Overall Finished Width							
Up To		24	36	48	60	72	84	96	108
36		277	420	505	579	653	728	802	980
48		304	460	544	628	816	900	984	1,067
60		292	489	583	676	874	968	1,061	1,259
72		311	518	622	725	932	1,036	1,139	1,346
84		435	652	765	878	1,095	1,208	1,321	1,538
96		454	681	804	926	1,153	1,276	1,399	1,625
108		473	710	842	975	1,211	1,344	1,476	1,713

		Series 28							
Length		Overall Finished Width							
Up To		24	36	48	60	72	84	96	108
36		281	428	513	587	661	736	810	992
48		308	468	552	636	828	912	996	1,079
60		296	497	591	684	886	980	1,073	1,275
72		315	526	630	733	944	1,048	1,151	1,362
84		443	664	777	890	1,111	1,224	1,337	1,558
96		462	693	816	938	1,169	1,292	1,415	1,645
108		481	722	854	987	1,227	1,360	1,492	1,733

		Series 29							
Length		Overall Finished Width							
Up To		24	36	48	60	72	84	96	108
36		285	435	521	595	669	744	818	1,004
48		312	476	560	644	840	924	1,008	1,091
60		300	505	599	692	898	992	1,085	1,291
72		319	534	638	741	956	1,060	1,163	1,378
84		451	676	789	902	1,127	1,240	1,353	1,578
96		470	705	828	950	1,185	1,308	1,431	1,665
108		489	734	866	999	1,243	1,376	1,508	1,753

		Series 30							
Length		Overall Finished Width							
Up To		24	36	48	60	72	84	96	108
36		291	446	533	607	681	756	830	1,022
48		318	488	572	656	858	942	1,026	1,109
60		306	517	611	704	916	1,010	1,103	1,315
72		325	546	650	753	974	1,078	1,181	1,402
84		463	694	807	920	1,151	1,264	1,377	1,608
96		482	723	846	968	1,209	1,332	1,455	1,695
108		501	752	884	1,017	1,267	1,400	1,532	1,783

NOTE: For relaxed and slouch style shades, please specify the length option: to the bottom of the scallop, to the bottom of the weight bar OR straight bottom

FABRIC SHADES: Roman — Unlined

Chart pricing includes board mount or headrail mount. Sizes and series numbers beyond what is listed in the charts below are available—please submit these quote requests via fax or email. **NOTE: For headrail mount:** manual—maximum width 139"; motorized—maximum width 94". For larger widths, please order board mount shades.

RELAXED & SLOUCH ROMAN SHADE

		Series 31							
		Overall Finished Width							
Length	Up To	24	36	48	60	72	84	96	108
36		294	451	539	613	687	762	836	1,031
48		321	494	578	662	867	951	1,035	1,118
60		309	523	617	710	925	1,019	1,112	1,327
72		328	552	656	759	983	1,087	1,190	1,414
84		469	703	816	929	1,163	1,276	1,389	1,623
96		488	732	855	977	1,221	1,344	1,467	1,710
108		507	761	893	1,026	1,279	1,412	1,544	1,798

		Series 32							
		Overall Finished Width							
Length	Up To	24	36	48	60	72	84	96	108
36		298	458	547	621	695	770	844	1,043
48		325	502	586	670	879	963	1,047	1,130
60		313	531	625	718	937	1,031	1,124	1,343
72		332	560	664	767	995	1,099	1,202	1,430
84		477	715	828	941	1,179	1,292	1,405	1,643
96		496	744	867	989	1,237	1,360	1,483	1,730
108		515	773	905	1,038	1,295	1,428	1,560	1,818

		Series 33							
		Overall Finished Width							
Length	Up To	24	36	48	60	72	84	96	108
36		303	467	557	631	705	780	854	1,058
48		330	512	596	680	894	978	1,062	1,145
60		318	541	635	728	952	1,046	1,139	1,363
72		337	570	674	777	1,010	1,114	1,217	1,450
84		487	730	843	956	1,199	1,312	1,425	1,668
96		506	759	882	1,004	1,257	1,380	1,503	1,755
108		525	788	920	1,053	1,315	1,448	1,580	1,843

		Series 34							
		Overall Finished Width							
Length	Up To	24	36	48	60	72	84	96	108
36		313	485	577	651	725	800	874	1,088
48		340	532	616	700	924	1,008	1,092	1,175
60		328	561	655	748	982	1,076	1,169	1,403
72		347	590	694	797	1,040	1,144	1,247	1,490
84		507	760	873	986	1,239	1,352	1,465	1,718
96		526	789	912	1,034	1,297	1,420	1,543	1,805
108		545	818	950	1,083	1,355	1,488	1,620	1,893

		Series 35							
		Overall Finished Width							
Length	Up To	24	36	48	60	72	84	96	108
36		323	503	597	671	745	820	894	1,118
48		350	552	636	720	954	1,038	1,122	1,205
60		338	581	675	768	1,012	1,106	1,199	1,443
72		357	610	714	817	1,070	1,174	1,277	1,530
84		527	790	903	1,016	1,279	1,392	1,505	1,768
96		546	819	942	1,064	1,337	1,460	1,583	1,855
108		565	848	980	1,113	1,395	1,528	1,660	1,943

		Series 36							
		Overall Finished Width							
Length	Up To	24	36	48	60	72	84	96	108
36		335	525	621	695	769	844	918	1,154
48		362	576	660	744	990	1,074	1,158	1,241
60		350	605	699	792	1,048	1,142	1,235	1,491
72		369	634	738	841	1,106	1,210	1,313	1,578
84		551	826	939	1,052	1,327	1,440	1,553	1,828
96		570	855	978	1,100	1,385	1,508	1,631	1,915
108		589	884	1,016	1,149	1,443	1,576	1,708	2,003

		Series 37							
		Overall Finished Width							
Length	Up To	24	36	48	60	72	84	96	108
36		353	557	657	731	805	880	954	1,208
48		380	612	696	780	1,044	1,128	1,212	1,295
60		368	641	735	828	1,102	1,196	1,289	1,563
72		387	670	774	877	1,160	1,264	1,367	1,650
84		587	880	993	1,106	1,399	1,512	1,625	1,918
96		606	909	1,032	1,154	1,457	1,580	1,703	2,005
108		625	938	1,070	1,203	1,515	1,648	1,780	2,093

		Series 38							
		Overall Finished Width							
Length	Up To	24	36	48	60	72	84	96	108
36		393	629	737	811	885	960	1,034	1,328
48		420	692	776	860	1,164	1,248	1,332	1,415
60		408	721	815	908	1,222	1,316	1,409	1,723
72		427	750	854	957	1,280	1,384	1,487	1,810
84		667	1,000	1,113	1,226	1,559	1,672	1,785	2,118
96		686	1,029	1,152	1,274	1,617	1,740	1,863	2,205
108		705	1,058	1,190	1,323	1,675	1,808	1,940	2,293

NOTE: For relaxed and slouch style shades, please specify the length option: to the bottom of the scallop, to the bottom of the weight bar OR straight bottom

FABRIC SHADES: Roman — Lined (Lining 01000)

Chart pricing includes board mount or headrail mount. Sizes and series numbers beyond what is listed in the charts below are available—please submit these quote requests via fax or email. **NOTE: For headrail mount:** manual—maximum width 112"; motorized—maximum width 75". For larger widths, please order board mount shades.

RELAXED & SLOUCH ROMAN SHADE

Series 07

Length Up To	Overall Finished Width							
	24	36	48	60	72	84	96	108
36	227	327	401	478	556	634	711	834
48	258	356	444	533	666	755	843	931
60	244	388	488	587	731	831	930	1,074
72	266	421	531	641	796	907	1,017	1,172
84	333	499	620	741	907	1,028	1,149	1,315
96	354	531	663	795	972	1,104	1,236	1,412
108	376	564	706	849	1,037	1,180	1,322	1,510

Series 08

Length Up To	Overall Finished Width							
	24	36	48	60	72	84	96	108
36	232	373	411	488	566	644	721	849
48	263	366	454	543	681	770	858	946
60	249	398	498	597	746	846	945	1,094
72	271	431	541	651	811	922	1,032	1,192
84	343	514	635	756	927	1,048	1,169	1,340
96	364	546	678	810	992	1,124	1,256	1,437
108	386	579	721	864	1,057	1,200	1,342	1,535

Series 09

Length Up To	Overall Finished Width							
	24	36	48	60	72	84	96	108
36	236	343	419	496	574	652	729	861
48	267	374	462	551	693	782	870	958
60	253	406	506	605	758	858	957	1,110
72	275	439	549	659	823	934	1,044	1,208
84	351	526	647	768	943	1,064	1,185	1,360
96	372	558	690	822	1,008	1,140	1,272	1,457
108	394	591	733	876	1,073	1,216	1,358	1,555

Series 10

Length Up To	Overall Finished Width							
	24	36	48	60	72	84	96	108
36	240	389	427	504	582	660	737	873
48	271	382	470	559	705	794	882	970
60	257	414	514	613	770	870	969	1,126
72	279	447	557	667	835	946	1,056	1,224
84	359	538	659	780	959	1,080	1,201	1,380
96	380	570	702	834	1,024	1,156	1,288	1,477
108	402	603	745	888	1,089	1,232	1,374	1,575

Series 11

Length Up To	Overall Finished Width							
	24	36	48	60	72	84	96	108
36	244	358	435	512	590	668	745	885
48	275	390	478	567	717	806	894	982
60	261	422	522	621	782	882	981	1,142
72	283	455	565	675	847	958	1,068	1,240
84	367	550	671	792	975	1,096	1,217	1,400
96	388	582	714	846	1,040	1,172	1,304	1,497
108	410	615	757	900	1,105	1,248	1,390	1,595

Series 12

Length Up To	Overall Finished Width							
	24	36	48	60	72	84	96	108
36	248	405	443	520	598	676	753	897
48	279	398	486	575	729	818	906	994
60	265	430	530	629	794	894	993	1,158
72	287	463	573	683	859	970	1,080	1,256
84	375	562	683	804	991	1,112	1,233	1,420
96	396	594	726	858	1,056	1,188	1,320	1,517
108	418	627	769	912	1,121	1,264	1,406	1,615

Series 13

Length Up To	Overall Finished Width							
	24	36	48	60	72	84	96	108
36	252	372	451	528	606	684	761	909
48	283	406	494	583	741	830	918	1,006
60	269	438	538	637	806	906	1,005	1,174
72	291	471	581	691	871	982	1,092	1,272
84	383	574	695	816	1,007	1,128	1,249	1,440
96	404	606	738	870	1,072	1,204	1,336	1,537
108	426	639	781	924	1,137	1,280	1,422	1,635

Series 14

Length Up To	Overall Finished Width							
	24	36	48	60	72	84	96	108
36	256	421	459	536	614	692	769	921
48	287	414	502	591	753	842	930	1,018
60	273	446	546	645	818	918	1,017	1,190
72	295	479	589	699	883	994	1,104	1,288
84	391	586	707	828	1,023	1,144	1,265	1,460
96	412	618	750	882	1,088	1,220	1,352	1,557
108	434	651	793	936	1,153	1,296	1,438	1,655

Series 15

Length Up To	Overall Finished Width							
	24	36	48	60	72	84	96	108
36	260	386	467	544	622	700	777	933
48	291	422	510	599	765	854	942	1,030
60	277	454	554	653	830	930	1,029	1,206
72	299	487	597	707	895	1,006	1,116	1,304
84	399	598	719	840	1,039	1,160	1,281	1,480
96	420	630	762	894	1,104	1,236	1,368	1,577
108	442	663	805	948	1,169	1,312	1,454	1,675

Series 16

Length Up To	Overall Finished Width							
	24	36	48	60	72	84	96	108
36	264	437	475	552	630	708	785	945
48	295	430	518	607	777	866	954	1,042
60	281	462	562	661	842	942	1,041	1,222
72	303	495	605	715	907	1,018	1,128	1,320
84	407	610	731	852	1,055	1,176	1,297	1,500
96	428	642	774	906	1,120	1,252	1,384	1,597
108	450	675	817	960	1,185	1,328	1,470	1,695

Series 17

Length Up To	Overall Finished Width							
	24	36	48	60	72	84	96	108
36	268	401	483	560	638	716	793	957
48	299	438	526	615	789	878	966	1,054
60	285	470	570	669	854	954	1,053	1,238
72	307	503	613	723	919	1,030	1,140	1,336
84	415	622	743	864	1,071	1,192	1,313	1,520
96	436	654	786	918	1,136	1,268	1,400	1,617
108	458	687	829	972	1,201	1,344	1,486	1,715

Series 18

Length Up To	Overall Finished Width							
	24	36	48	60	72	84	96	108
36	272	453	491	568	646	724	801	969
48	303	446	534	623	801	890	978	1,066
60	289	478	578	677	866	966	1,065	1,254
72	311	511	621	731	931	1,042	1,152	1,352
84	423	634	755	876	1,087	1,208	1,329	1,540
96	444	666	798	930	1,152	1,284	1,416	1,637
108	466	699	841	984	1,217	1,360	1,502	1,735

NOTE: For relaxed and slouch style shades, please specify the length option: to the bottom of the scallop, to the bottom of the weight bar OR straight bottom

FABRIC SHADES: Roman — Lined (Lining 01000)

Chart pricing includes board mount or headrail mount. Sizes and series numbers beyond what is listed in the charts below are available—please submit these quote requests via fax or email. **NOTE: For headrail mount:** manual—maximum width 112"; motorized—maximum width 75". For larger widths, please order board mount shades.

RELAXED & SLOUCH ROMAN SHADE

		Series 19							
		Overall Finished Width							
Length Up To		24	36	48	60	72	84	96	108
36		276	415	499	576	654	732	809	981
48		307	454	542	631	813	902	990	1,078
60		293	486	586	685	878	978	1,077	1,270
72		315	519	629	739	943	1,054	1,164	1,368
84		431	646	767	888	1,103	1,224	1,345	1,560
96		452	678	810	942	1,168	1,300	1,432	1,657
108		474	711	853	996	1,233	1,376	1,518	1,755

		Series 20							
		Overall Finished Width							
Length Up To		24	36	48	60	72	84	96	108
36		280	469	507	584	662	740	817	993
48		311	462	550	639	825	914	1,002	1,090
60		297	494	594	693	890	990	1,089	1,286
72		319	527	637	747	955	1,066	1,176	1,384
84		439	658	779	900	1,119	1,240	1,361	1,580
96		460	690	822	954	1,184	1,316	1,448	1,677
108		482	723	865	1,008	1,249	1,392	1,534	1,775

		Series 21							
		Overall Finished Width							
Length Up To		24	36	48	60	72	84	96	108
36		284	430	515	592	670	748	825	1,005
48		315	470	558	647	837	926	1,014	1,102
60		301	502	602	701	902	1,002	1,101	1,302
72		323	535	645	755	967	1,078	1,188	1,400
84		447	670	791	912	1,135	1,256	1,377	1,600
96		468	702	834	966	1,200	1,332	1,464	1,697
108		490	735	877	1,020	1,265	1,408	1,550	1,795

		Series 22							
		Overall Finished Width							
Length Up To		24	36	48	60	72	84	96	108
36		288	485	523	600	678	756	833	1,017
48		319	478	566	655	849	938	1,026	1,114
60		305	510	610	709	914	1,014	1,113	1,318
72		327	543	653	763	979	1,090	1,200	1,416
84		455	682	803	924	1,151	1,272	1,393	1,620
96		476	714	846	978	1,216	1,348	1,480	1,717
108		498	747	889	1,032	1,281	1,424	1,566	1,815

		Series 23							
		Overall Finished Width							
Length Up To		24	36	48	60	72	84	96	108
36		292	444	531	608	686	764	841	1,029
48		323	486	574	663	861	950	1,038	1,126
60		309	518	618	717	926	1,026	1,125	1,334
72		331	551	661	771	991	1,102	1,212	1,432
84		463	694	815	936	1,167	1,288	1,409	1,640
96		484	726	858	990	1,232	1,364	1,496	1,737
108		506	759	901	1,044	1,297	1,440	1,582	1,835

		Series 24							
		Overall Finished Width							
Length Up To		24	36	48	60	72	84	96	108
36		296	501	539	616	694	772	849	1,041
48		327	494	582	671	873	962	1,050	1,138
60		313	526	626	725	938	1,038	1,137	1,350
72		335	559	669	779	1,003	1,114	1,224	1,448
84		471	706	827	948	1,183	1,304	1,425	1,660
96		492	738	870	1,002	1,248	1,380	1,512	1,757
108		514	771	913	1,056	1,313	1,456	1,598	1,855

		Series 25							
		Overall Finished Width							
Length Up To		24	36	48	60	72	84	96	108
36		302	462	551	628	706	784	861	1,059
48		333	506	594	683	891	980	1,068	1,156
60		319	538	638	737	956	1,056	1,155	1,374
72		341	571	681	791	1,021	1,132	1,242	1,472
84		483	724	845	966	1,207	1,328	1,449	1,690
96		504	756	888	1,020	1,272	1,404	1,536	1,787
108		526	789	931	1,074	1,337	1,480	1,622	1,885

		Series 26							
		Overall Finished Width							
Length Up To		24	36	48	60	72	84	96	108
36		306	521	559	636	714	792	869	1,071
48		337	514	602	691	903	992	1,080	1,168
60		323	546	646	745	968	1,068	1,167	1,390
72		345	579	689	799	1,033	1,144	1,254	1,488
84		491	736	857	978	1,223	1,344	1,465	1,710
96		512	768	900	1,032	1,288	1,420	1,552	1,807
108		534	801	943	1,086	1,353	1,496	1,638	1,905

		Series 27							
		Overall Finished Width							
Length Up To		24	36	48	60	72	84	96	108
36		310	476	567	644	722	800	877	1,083
48		341	522	610	699	915	1,004	1,092	1,180
60		327	554	654	753	980	1,080	1,179	1,406
72		349	587	697	807	1,045	1,156	1,266	1,504
84		499	748	869	990	1,239	1,360	1,481	1,730
96		520	780	912	1,044	1,304	1,436	1,568	1,827
108		542	813	955	1,098	1,369	1,512	1,654	1,925

		Series 28							
		Overall Finished Width							
Length Up To		24	36	48	60	72	84	96	108
36		314	537	575	652	730	808	885	1,095
48		345	530	618	707	927	1,016	1,104	1,192
60		331	562	662	761	992	1,092	1,191	1,422
72		353	595	705	815	1,057	1,168	1,278	1,520
84		507	760	881	1,002	1,255	1,376	1,497	1,750
96		528	792	924	1,056	1,320	1,452	1,584	1,847
108		550	825	967	1,110	1,385	1,528	1,670	1,945

		Series 29							
		Overall Finished Width							
Length Up To		24	36	48	60	72	84	96	108
36		318	491	583	660	738	816	893	1,107
48		349	538	626	715	939	1,028	1,116	1,204
60		335	570	670	769	1,004	1,104	1,203	1,438
72		357	603	713	823	1,069	1,180	1,290	1,536
84		515	772	893	1,014	1,271	1,392	1,513	1,770
96		536	804	936	1,068	1,336	1,468	1,600	1,867
108		558	837	979	1,122	1,401	1,544	1,686	1,965

		Series 30							
		Overall Finished Width							
Length Up To		24	36	48	60	72	84	96	108
36		324	557	595	672	750	828	905	1,125
48		355	550	638	727	957	1,046	1,134	1,222
60		341	582	682	781	1,022	1,122	1,221	1,462
72		363	615	725	835	1,087	1,198	1,308	1,560
84		527	790	911	1,032	1,295	1,416	1,537	1,800
96		548	822	954	1,086	1,360	1,492	1,624	1,897
108		570	855	997	1,140	1,425	1,568	1,710	1,995

NOTE: For relaxed and slouch style shades, please specify the length option: to the bottom of the scallop, to the bottom of the weight bar OR straight bottom

FABRIC SHADES: Roman — Lined (Lining 01000)

Chart pricing includes board mount or headrail mount. Sizes and series numbers beyond what is listed in the charts below are available—please submit these quote requests via fax or email. **NOTE: For headrail mount:** manual—maximum width 112"; motorized—maximum width 75". For larger widths, please order board mount shades.

RELAXED & SLOUCH ROMAN SHADE

		Series 31							
		Overall Finished Width							
Length Up To		24	36	48	60	72	84	96	108
36		327	507	601	678	756	834	911	1,134
48		358	556	644	733	966	1,055	1,143	1,231
60		344	588	688	787	1,031	1,131	1,230	1,474
72		366	621	731	841	1,096	1,207	1,317	1,572
84		533	799	920	1,041	1,307	1,428	1,549	1,815
96		554	831	963	1,095	1,372	1,504	1,636	1,912
108		576	864	1,006	1,149	1,437	1,580	1,722	2,010

		Series 32							
		Overall Finished Width							
Length Up To		24	36	48	60	72	84	96	108
36		331	571	609	686	764	842	919	1,146
48		362	564	652	741	978	1,067	1,155	1,243
60		348	596	696	795	1,043	1,143	1,242	1,490
72		370	629	739	849	1,108	1,219	1,329	1,588
84		541	811	932	1,053	1,323	1,444	1,565	1,835
96		562	843	975	1,107	1,388	1,520	1,652	1,932
108		584	876	1,018	1,161	1,453	1,596	1,738	2,030

		Series 33							
		Overall Finished Width							
Length Up To		24	36	48	60	72	84	96	108
36		336	523	619	696	774	852	929	1,161
48		367	574	662	751	993	1,082	1,170	1,258
60		353	606	706	805	1,058	1,158	1,257	1,510
72		375	639	749	859	1,123	1,234	1,344	1,608
84		551	826	947	1,068	1,343	1,464	1,585	1,860
96		572	858	990	1,122	1,408	1,540	1,672	1,957
108		594	891	1,033	1,176	1,473	1,616	1,758	2,055

		Series 34							
		Overall Finished Width							
Length Up To		24	36	48	60	72	84	96	108
36		346	601	639	716	794	872	949	1,191
48		377	594	682	771	1,023	1,112	1,200	1,288
60		363	626	726	825	1,088	1,188	1,287	1,550
72		385	659	769	879	1,153	1,264	1,374	1,648
84		571	856	977	1,098	1,383	1,504	1,625	1,910
96		592	888	1,020	1,152	1,448	1,580	1,712	2,007
108		614	921	1,063	1,206	1,513	1,656	1,798	2,105

		Series 35							
		Overall Finished Width							
Length Up To		24	36	48	60	72	84	96	108
36		356	559	659	736	814	892	969	1,221
48		387	614	702	791	1,053	1,142	1,230	1,318
60		373	646	746	845	1,118	1,218	1,317	1,590
72		395	679	789	899	1,183	1,294	1,404	1,688
84		591	886	1,007	1,128	1,423	1,544	1,665	1,960
96		612	918	1,050	1,182	1,488	1,620	1,752	2,057
108		634	951	1,093	1,236	1,553	1,696	1,838	2,155

		Series 36							
		Overall Finished Width							
Length Up To		24	36	48	60	72	84	96	108
36		368	645	683	760	838	916	993	1,257
48		399	638	726	815	1,089	1,178	1,266	1,354
60		385	670	770	869	1,154	1,254	1,353	1,638
72		407	703	813	923	1,219	1,330	1,440	1,736
84		615	922	1,043	1,164	1,471	1,592	1,713	2,020
96		636	954	1,086	1,218	1,536	1,668	1,800	2,117
108		658	987	1,129	1,272	1,601	1,744	1,886	2,215

		Series 37							
		Overall Finished Width							
Length Up To		24	36	48	60	72	84	96	108
36		386	613	719	796	874	952	1,029	1,311
48		417	674	762	851	1,143	1,232	1,320	1,408
60		403	706	806	905	1,208	1,308	1,407	1,710
72		425	739	849	959	1,273	1,384	1,494	1,808
84		651	976	1,097	1,218	1,543	1,664	1,785	2,110
96		672	1,008	1,140	1,272	1,608	1,740	1,872	2,207
108		694	1,041	1,183	1,326	1,673	1,816	1,958	2,305

		Series 38							
		Overall Finished Width							
Length Up To		24	36	48	60	72	84	96	108
36		426	761	799	876	954	1,032	1,109	1,431
48		457	754	842	931	1,263	1,352	1,440	1,528
60		443	786	886	985	1,328	1,428	1,527	1,870
72		465	819	929	1,039	1,393	1,504	1,614	1,968
84		731	1,096	1,217	1,338	1,703	1,824	1,945	2,310
96		752	1,128	1,260	1,392	1,768	1,900	2,032	2,407
108		774	1,161	1,303	1,446	1,833	1,976	2,118	2,505

NOTE: For relaxed and slouch style shades, please specify the length option: to the bottom of the scallop, to the bottom of the weight bar OR straight bottom

FABRIC SHADES: Roman — Unlined

Chart pricing includes board mount or headrail mount. Sizes and series numbers beyond what is listed in the charts below are available—please submit these quote requests via fax or email. **NOTE: For headrail mount:** manual—maximum width 135"; motorized—maximum width 90". For larger widths, please order board mount shades.

BUTTERFLY ROMAN SHADE

Series 07

Length Up To	Overall Finished Width							
	24	36	48	60	72	84	96	108
36	225	316	357	436	514	593	693	771
48	230	312	402	513	603	693	783	872
60	245	346	447	569	670	771	893	994
72	267	379	492	625	737	850	983	1,095
84	311	434	558	702	826	949	1,094	1,217
96	333	468	603	758	893	1,028	1,184	1,318
108	355	501	647	814	960	1,106	1,273	1,419

Series 08

Length Up To	Overall Finished Width							
	24	36	48	60	72	84	96	108
36	235	326	367	446	524	603	708	786
48	239	290	371	475	556	637	718	799
60	255	356	457	584	685	786	913	1,014
72	277	389	502	640	752	865	1,003	1,115
84	326	449	573	722	846	969	1,119	1,242
96	348	483	618	778	913	1,048	1,209	1,343
108	370	516	662	834	980	1,126	1,298	1,444

Series 09

Length Up To	Overall Finished Width							
	24	36	48	60	72	84	96	108
36	243	334	375	454	532	611	720	798
48	246	330	420	540	630	720	810	899
60	263	364	465	596	697	798	929	1,030
72	285	397	510	652	764	877	1,019	1,131
84	338	461	585	738	862	985	1,139	1,262
96	360	495	630	794	929	1,064	1,229	1,363
108	382	528	674	850	996	1,142	1,318	1,464

Series 10

Length Up To	Overall Finished Width							
	24	36	48	60	72	84	96	108
36	251	342	383	462	540	619	732	810
48	253	304	385	497	578	659	739	820
60	271	372	473	608	709	810	945	1,046
72	293	405	518	664	776	889	1,035	1,147
84	350	473	597	754	878	1,001	1,159	1,282
96	372	507	642	810	945	1,080	1,249	1,383
108	394	540	686	866	1,012	1,158	1,338	1,484

Series 11

Length Up To	Overall Finished Width							
	24	36	48	60	72	84	96	108
36	259	350	391	470	548	627	744	822
48	260	346	436	564	654	744	834	923
60	279	380	481	620	721	822	961	1,062
72	301	413	526	676	788	901	1,051	1,163
84	362	485	609	770	894	1,017	1,179	1,302
96	384	519	654	826	961	1,096	1,269	1,403
108	406	552	698	882	1,028	1,174	1,358	1,504

Series 12

Length Up To	Overall Finished Width							
	24	36	48	60	72	84	96	108
36	267	358	399	478	556	635	756	834
48	268	319	400	518	599	680	761	842
60	287	388	489	632	733	834	977	1,078
72	309	421	534	688	800	913	1,067	1,179
84	374	497	621	786	910	1,033	1,199	1,322
96	396	531	666	842	977	1,112	1,289	1,423
108	418	564	710	898	1,044	1,190	1,378	1,524

Series 13

Length Up To	Overall Finished Width							
	24	36	48	60	72	84	96	108
36	275	366	407	486	564	643	768	846
48	275	362	452	588	678	768	858	947
60	295	396	497	644	745	846	993	1,094
72	317	429	542	700	812	925	1,083	1,195
84	386	509	633	802	926	1,049	1,219	1,342
96	408	543	678	858	993	1,128	1,309	1,443
108	430	576	722	914	1,060	1,206	1,398	1,544

Series 14

Length Up To	Overall Finished Width							
	24	36	48	60	72	84	96	108
36	283	374	415	494	572	651	780	858
48	282	333	414	540	621	702	783	864
60	303	404	505	656	757	858	1,009	1,110
72	325	437	550	712	824	937	1,099	1,211
84	398	521	645	818	942	1,065	1,239	1,362
96	420	555	690	874	1,009	1,144	1,329	1,463
108	442	588	734	930	1,076	1,222	1,418	1,564

Series 15

Length Up To	Overall Finished Width							
	24	36	48	60	72	84	96	108
36	291	382	423	502	580	659	792	870
48	289	378	468	612	702	792	882	971
60	311	412	513	668	769	870	1,025	1,126
72	333	445	558	724	836	949	1,115	1,227
84	410	533	657	834	958	1,081	1,259	1,382
96	432	567	702	890	1,025	1,160	1,349	1,483
108	454	600	746	946	1,092	1,238	1,438	1,584

Series 16

Length Up To	Overall Finished Width							
	24	36	48	60	72	84	96	108
36	299	390	431	510	588	667	804	882
48	296	348	428	562	642	723	804	885
60	319	420	521	680	781	882	1,041	1,142
72	341	453	566	736	848	961	1,131	1,243
84	422	545	669	850	974	1,097	1,279	1,402
96	444	579	714	906	1,041	1,176	1,369	1,503
108	466	612	758	962	1,108	1,254	1,458	1,604

Series 17

Length Up To	Overall Finished Width							
	24	36	48	60	72	84	96	108
36	307	398	439	518	596	675	816	894
48	304	394	484	636	726	816	906	995
60	327	428	529	692	793	894	1,057	1,158
72	349	461	574	748	860	973	1,147	1,259
84	434	557	681	866	990	1,113	1,299	1,422
96	456	591	726	922	1,057	1,192	1,389	1,523
108	478	624	770	978	1,124	1,270	1,478	1,624

Series 18

Length Up To	Overall Finished Width							
	24	36	48	60	72	84	96	108
36	315	406	447	526	604	683	828	906
48	311	362	443	583	664	745	826	907
60	335	436	537	704	805	906	1,073	1,174
72	357	469	582	760	872	985	1,163	1,275
84	446	569	693	882	1,006	1,129	1,319	1,442
96	468	603	738	938	1,073	1,208	1,409	1,543
108	490	636	782	994	1,140	1,286	1,498	1,644

NOTE: For butterfly style shades, please specify the length option: to the bottom of the scallop, to the bottom of the weight bar OR straight bottom

FABRIC SHADES: Roman — Unlined

Chart pricing includes board mount or headrail mount. Sizes and series numbers beyond what is listed in the charts below are available—please submit these quote requests via fax or email. **NOTE: For headrail mount:** manual—maximum width 135"; motorized—maximum width 90". For larger widths, please order board mount shades.

BUTTERFLY ROMAN SHADE

		Series 19							
		Overall Finished Width							
Length Up To		24	36	48	60	72	84	96	108
36		323	414	455	534	612	691	840	918
48		318	410	500	660	750	840	930	1,019
60		343	444	545	716	817	918	1,089	1,190
72		365	477	590	772	884	997	1,179	1,291
84		458	581	705	898	1,022	1,145	1,339	1,462
96		480	615	750	954	1,089	1,224	1,429	1,563
108		502	648	794	1,010	1,156	1,302	1,518	1,664

		Series 20							
		Overall Finished Width							
Length Up To		24	36	48	60	72	84	96	108
36		331	422	463	542	620	699	852	930
48		325	376	457	605	686	767	847	928
60		351	452	553	728	829	930	1,105	1,206
72		373	485	598	784	896	1,009	1,195	1,307
84		470	593	717	914	1,038	1,161	1,359	1,482
96		492	627	762	970	1,105	1,240	1,449	1,583
108		514	660	806	1,026	1,172	1,318	1,538	1,684

		Series 21							
		Overall Finished Width							
Length Up To		24	36	48	60	72	84	96	108
36		339	430	471	550	628	707	864	942
48		332	426	516	684	774	864	954	1,043
60		359	460	561	740	841	942	1,121	1,222
72		381	493	606	796	908	1,021	1,211	1,323
84		482	605	729	930	1,054	1,177	1,379	1,502
96		504	639	774	986	1,121	1,256	1,469	1,603
108		526	672	818	1,042	1,188	1,334	1,558	1,704

		Series 22							
		Overall Finished Width							
Length Up To		24	36	48	60	72	84	96	108
36		347	438	479	558	636	715	876	954
48		340	391	472	626	707	788	869	950
60		367	468	569	752	853	954	1,137	1,238
72		389	501	614	808	920	1,033	1,227	1,339
84		494	617	741	946	1,070	1,193	1,399	1,522
96		516	651	786	1,002	1,137	1,272	1,489	1,623
108		538	684	830	1,058	1,204	1,350	1,578	1,724

		Series 23							
		Overall Finished Width							
Length Up To		24	36	48	60	72	84	96	108
36		355	446	487	566	644	723	888	966
48		347	442	532	708	798	888	978	1,067
60		375	476	577	764	865	966	1,153	1,254
72		397	509	622	820	932	1,045	1,243	1,355
84		506	629	753	962	1,086	1,209	1,419	1,542
96		528	663	798	1,018	1,153	1,288	1,509	1,643
108		550	696	842	1,074	1,220	1,366	1,598	1,744

		Series 24							
		Overall Finished Width							
Length Up To		24	36	48	60	72	84	96	108
36		363	454	495	574	652	731	900	978
48		354	405	486	648	729	810	891	972
60		383	484	585	776	877	978	1,169	1,270
72		405	517	630	832	944	1,057	1,259	1,371
84		518	641	765	978	1,102	1,225	1,439	1,562
96		540	675	810	1,034	1,169	1,304	1,529	1,663
108		562	708	854	1,090	1,236	1,382	1,618	1,764

		Series 25							
		Overall Finished Width							
Length Up To		24	36	48	60	72	84	96	108
36		375	466	507	586	664	743	918	996
48		365	462	552	738	828	918	1,008	1,097
60		395	496	597	794	895	996	1,193	1,294
72		417	529	642	850	962	1,075	1,283	1,395
84		536	659	783	1,002	1,126	1,249	1,469	1,592
96		558	693	828	1,058	1,193	1,328	1,559	1,693
108		580	726	872	1,114	1,260	1,406	1,648	1,794

		Series 26							
		Overall Finished Width							
Length Up To		24	36	48	60	72	84	96	108
36		383	474	515	594	672	751	930	1,008
48		372	423	504	675	756	837	918	999
60		403	504	605	806	907	1,008	1,209	1,310
72		425	537	650	862	974	1,087	1,299	1,411
84		548	671	795	1,018	1,142	1,265	1,489	1,612
96		570	705	840	1,074	1,209	1,344	1,579	1,713
108		592	738	884	1,130	1,276	1,422	1,668	1,814

		Series 27							
		Overall Finished Width							
Length Up To		24	36	48	60	72	84	96	108
36		391	482	523	602	680	759	942	1,020
48		379	478	568	762	852	942	1,032	1,121
60		411	512	613	818	919	1,020	1,225	1,326
72		433	545	658	874	986	1,099	1,315	1,427
84		560	683	807	1,034	1,158	1,281	1,509	1,632
96		582	717	852	1,090	1,225	1,360	1,599	1,733
108		604	750	896	1,146	1,292	1,438	1,688	1,834

		Series 28							
		Overall Finished Width							
Length Up To		24	36	48	60	72	84	96	108
36		399	490	531	610	688	767	954	1,032
48		386	438	518	697	777	858	939	1,020
60		419	520	621	830	931	1,032	1,241	1,342
72		441	553	666	886	998	1,111	1,331	1,443
84		572	695	819	1,050	1,174	1,297	1,529	1,652
96		594	729	864	1,106	1,241	1,376	1,619	1,753
108		616	762	908	1,162	1,308	1,454	1,708	1,854

		Series 29							
		Overall Finished Width							
Length Up To		24	36	48	60	72	84	96	108
36		407	498	539	618	696	775	966	1,044
48		394	494	584	786	876	966	1,056	1,145
60		427	528	629	842	943	1,044	1,257	1,358
72		449	561	674	898	1,010	1,123	1,347	1,459
84		584	707	831	1,066	1,190	1,313	1,549	1,672
96		606	741	876	1,122	1,257	1,392	1,639	1,773
108		628	774	920	1,178	1,324	1,470	1,728	1,874

		Series 30							
		Overall Finished Width							
Length Up To		24	36	48	60	72	84	96	108
36		419	510	551	630	708	787	984	1,062
48		404	456	536	724	804	885	966	1,047
60		439	540	641	860	961	1,062	1,281	1,382
72		461	573	686	916	1,028	1,141	1,371	1,483
84		602	725	849	1,090	1,214	1,337	1,579	1,702
96		624	759	894	1,146	1,281	1,416	1,669	1,803
108		646	792	938	1,202	1,348	1,494	1,758	1,904

NOTE: For butterfly style shades, please specify the length option: to the bottom of the scallop, to the bottom of the weight bar OR straight bottom

FABRIC SHADES: Roman — Unlined

Chart pricing includes board mount or headrail mount. Sizes and series numbers beyond what is listed in the charts below are available—please submit these quote requests via fax or email. **NOTE: For headrail mount:** manual—maximum width 135"; motorized—maximum width 90". For larger widths, please order board mount shades.

BUTTERFLY ROMAN SHADE

		Series 31							
		Overall Finished Width							
Length	Up To	24	36	48	60	72	84	96	108
36		425	516	557	636	714	793	993	1,071
48		410	512	602	813	903	993	1,083	1,172
60		445	546	647	869	970	1,071	1,293	1,394
72		467	579	692	925	1,037	1,150	1,383	1,495
84		611	734	858	1,102	1,226	1,349	1,594	1,717
96		633	768	903	1,158	1,293	1,428	1,684	1,818
108		655	801	947	1,214	1,360	1,506	1,773	1,919

		Series 32							
		Overall Finished Width							
Length	Up To	24	36	48	60	72	84	96	108
36		433	524	565	644	722	801	1,005	1,083
48		417	468	549	742	823	904	985	1,066
60		453	554	655	881	982	1,083	1,309	1,410
72		475	587	700	937	1,049	1,162	1,399	1,511
84		623	746	870	1,118	1,242	1,365	1,614	1,737
96		645	780	915	1,174	1,309	1,444	1,704	1,838
108		667	813	959	1,230	1,376	1,522	1,793	1,939

		Series 33							
		Overall Finished Width							
Length	Up To	24	36	48	60	72	84	96	108
36		443	534	575	654	732	811	1,020	1,098
48		426	530	620	840	930	1,020	1,110	1,199
60		463	564	665	896	997	1,098	1,329	1,430
72		485	597	710	952	1,064	1,177	1,419	1,531
84		638	761	885	1,138	1,262	1,385	1,639	1,762
96		660	795	930	1,194	1,329	1,464	1,729	1,863
108		682	828	974	1,250	1,396	1,542	1,818	1,964

		Series 34							
		Overall Finished Width							
Length	Up To	24	36	48	60	72	84	96	108
36		463	554	595	674	752	831	1,050	1,128
48		444	495	576	783	864	945	1,026	1,107
60		483	584	685	926	1,027	1,128	1,369	1,470
72		505	617	730	982	1,094	1,207	1,459	1,571
84		668	791	915	1,178	1,302	1,425	1,689	1,812
96		690	825	960	1,234	1,369	1,504	1,779	1,913
108		712	858	1,004	1,290	1,436	1,582	1,868	2,014

		Series 35							
		Overall Finished Width							
Length	Up To	24	36	48	60	72	84	96	108
36		483	574	615	694	772	851	1,080	1,158
48		462	570	660	900	990	1,080	1,170	1,259
60		503	604	705	956	1,057	1,158	1,409	1,510
72		525	637	750	1,012	1,124	1,237	1,499	1,611
84		698	821	945	1,218	1,342	1,465	1,739	1,862
96		720	855	990	1,274	1,409	1,544	1,829	1,963
108		742	888	1,034	1,330	1,476	1,622	1,918	2,064

		Series 36							
		Overall Finished Width							
Length	Up To	24	36	48	60	72	84	96	108
36		507	598	639	718	796	875	1,116	1,194
48		484	535	616	842	923	1,004	1,085	1,166
60		527	628	729	992	1,093	1,194	1,457	1,558
72		549	661	774	1,048	1,160	1,273	1,547	1,659
84		734	857	981	1,266	1,390	1,513	1,799	1,922
96		756	891	1,026	1,322	1,457	1,592	1,889	2,023
108		778	924	1,070	1,378	1,524	1,670	1,978	2,124

		Series 37							
		Overall Finished Width							
Length	Up To	24	36	48	60	72	84	96	108
36		543	634	675	754	832	911	1,170	1,248
48		516	630	720	990	1,080	1,170	1,260	1,349
60		563	664	765	1,046	1,147	1,248	1,529	1,630
72		585	697	810	1,102	1,214	1,327	1,619	1,731
84		788	911	1,035	1,338	1,462	1,585	1,889	2,012
96		810	945	1,080	1,394	1,529	1,664	1,979	2,113
108		832	978	1,124	1,450	1,596	1,742	2,068	2,214

		Series 38							
		Overall Finished Width							
Length	Up To	24	36	48	60	72	84	96	108
36		623	714	755	834	912	991	1,290	1,368
48		588	639	720	999	1,080	1,161	1,242	1,323
60		643	744	845	1,166	1,267	1,368	1,689	1,790
72		665	777	890	1,222	1,334	1,447	1,779	1,891
84		908	1,031	1,155	1,498	1,622	1,745	2,089	2,212
96		930	1,065	1,200	1,554	1,689	1,824	2,179	2,313
108		952	1,098	1,244	1,610	1,756	1,902	2,268	2,414

NOTE: For butterfly style shades, please specify the length option: to the bottom of the scallop, to the bottom of the weight bar OR straight bottom

FABRIC SHADES: Roman — Lined (Lining 01000)

Chart pricing includes board mount or headrail mount. Sizes and series numbers beyond what is listed in the charts below are available—please submit these quote requests via fax or email. **NOTE: For headrail mount:** manual—maximum width 107"; motorized—maximum width 70". For larger widths, please order board mount shades.

BUTTERFLY ROMAN SHADE

Series 07

Length Up To	Overall Finished Width							
	24	36	48	60	72	84	96	108
36	283	342	420	503	585	668	795	877
48	318	375	470	610	705	800	895	990
60	305	413	520	672	780	887	1,040	1,147
72	330	450	570	735	855	975	1,140	1,259
84	400	533	665	842	975	1,107	1,284	1,417
96	425	570	715	905	1,050	1,194	1,384	1,529
108	450	607	765	967	1,124	1,282	1,484	1,641

Series 08

Length Up To	Overall Finished Width							
	24	36	48	60	72	84	96	108
36	293	351	430	513	595	678	810	892
48	328	385	480	625	720	815	910	1,005
60	315	423	530	687	795	902	1,060	1,167
72	340	460	580	750	870	990	1,160	1,279
84	415	548	680	862	995	1,127	1,309	1,442
96	440	585	730	925	1,070	1,214	1,409	1,554
108	465	622	780	987	1,144	1,302	1,509	1,666

Series 09

Length Up To	Overall Finished Width							
	24	36	48	60	72	84	96	108
36	301	358	438	521	603	686	822	904
48	336	393	488	637	732	827	922	1,017
60	323	431	538	699	807	914	1,076	1,183
72	348	468	588	762	882	1,002	1,176	1,295
84	427	560	692	878	1,011	1,143	1,329	1,462
96	452	597	742	941	1,086	1,230	1,429	1,574
108	477	634	792	1,003	1,160	1,318	1,529	1,686

Series 10

Length Up To	Overall Finished Width							
	24	36	48	60	72	84	96	108
36	309	365	446	529	611	694	834	916
48	344	401	496	649	744	839	934	1,029
60	331	439	546	711	819	926	1,092	1,199
72	356	476	596	774	894	1,014	1,192	1,311
84	439	572	704	894	1,027	1,159	1,349	1,482
96	464	609	754	957	1,102	1,246	1,449	1,594
108	489	646	804	1,019	1,176	1,334	1,549	1,706

Series 11

Length Up To	Overall Finished Width							
	24	36	48	60	72	84	96	108
36	317	373	454	537	619	702	846	928
48	352	409	504	661	756	851	946	1,041
60	339	447	554	723	831	938	1,108	1,215
72	364	484	604	786	906	1,026	1,208	1,327
84	451	584	716	910	1,043	1,175	1,369	1,502
96	476	621	766	973	1,118	1,262	1,469	1,614
108	501	658	816	1,035	1,192	1,350	1,569	1,726

Series 12

Length Up To	Overall Finished Width							
	24	36	48	60	72	84	96	108
36	325	380	462	545	627	710	858	940
48	360	417	512	673	768	863	958	1,053
60	347	455	562	735	843	950	1,124	1,231
72	372	492	612	798	918	1,038	1,224	1,343
84	463	596	728	926	1,059	1,191	1,389	1,522
96	488	633	778	989	1,134	1,278	1,489	1,634
108	513	670	828	1,051	1,208	1,366	1,589	1,746

Series 13

Length Up To	Overall Finished Width							
	24	36	48	60	72	84	96	108
36	333	387	470	553	635	718	870	952
48	368	425	520	685	780	875	970	1,065
60	355	463	570	747	855	962	1,140	1,247
72	380	500	620	810	930	1,050	1,240	1,359
84	475	608	740	942	1,075	1,207	1,409	1,542
96	500	645	790	1,005	1,150	1,294	1,509	1,654
108	525	682	840	1,067	1,224	1,382	1,609	1,766

Series 14

Length Up To	Overall Finished Width							
	24	36	48	60	72	84	96	108
36	341	394	478	561	643	726	882	964
48	376	433	528	697	792	887	982	1,077
60	363	471	578	759	867	974	1,156	1,263
72	388	508	628	822	942	1,062	1,256	1,375
84	487	620	752	958	1,091	1,223	1,429	1,562
96	512	657	802	1,021	1,166	1,310	1,529	1,674
108	537	694	852	1,083	1,240	1,398	1,629	1,786

Series 15

Length Up To	Overall Finished Width							
	24	36	48	60	72	84	96	108
36	349	401	486	569	651	734	894	976
48	384	441	536	709	804	899	994	1,089
60	371	479	586	771	879	986	1,172	1,279
72	396	516	636	834	954	1,074	1,272	1,391
84	499	632	764	974	1,107	1,239	1,449	1,582
96	524	669	814	1,037	1,182	1,326	1,549	1,694
108	549	706	864	1,099	1,256	1,414	1,649	1,806

Series 16

Length Up To	Overall Finished Width							
	24	36	48	60	72	84	96	108
36	357	409	494	577	659	742	906	988
48	392	449	544	721	816	911	1,006	1,101
60	379	487	594	783	891	998	1,188	1,295
72	404	524	644	846	966	1,086	1,288	1,407
84	511	644	776	990	1,123	1,255	1,469	1,602
96	536	681	826	1,053	1,198	1,342	1,569	1,714
108	561	718	876	1,115	1,272	1,430	1,669	1,826

Series 17

Length Up To	Overall Finished Width							
	24	36	48	60	72	84	96	108
36	365	416	502	585	667	750	918	1,000
48	400	457	552	733	828	923	1,018	1,113
60	387	495	602	795	903	1,010	1,204	1,311
72	412	532	652	858	978	1,098	1,304	1,423
84	523	656	788	1,006	1,139	1,271	1,489	1,622
96	548	693	838	1,069	1,214	1,358	1,589	1,734
108	573	730	888	1,131	1,288	1,446	1,689	1,846

Series 18

Length Up To	Overall Finished Width							
	24	36	48	60	72	84	96	108
36	373	423	510	593	675	758	930	1,012
48	408	465	560	745	840	935	1,030	1,125
60	395	503	610	807	915	1,022	1,220	1,327
72	420	540	660	870	990	1,110	1,320	1,439
84	535	668	800	1,022	1,155	1,287	1,509	1,642
96	560	705	850	1,085	1,230	1,374	1,609	1,754
108	585	742	900	1,147	1,304	1,462	1,709	1,866

NOTE: For butterfly style shades, please specify the length option: to the bottom of the scallop, to the bottom of the weight bar OR straight bottom

FABRIC SHADES: Roman — Lined (Lining 01000)

Chart pricing includes board mount or headrail mount. Sizes and series numbers beyond what is listed in the charts below are available—please submit these quote requests via fax or email. **NOTE: For headrail mount:** manual—maximum width 107"; motorized—maximum width 70". For larger widths, please order board mount shades.

BUTTERFLY ROMAN SHADE

		Series 19							
		Overall Finished Width							
Length Up To		24	36	48	60	72	84	96	108
36		381	430	518	601	683	766	942	1,024
48		416	473	568	757	852	947	1,042	1,137
60		403	511	618	819	927	1,034	1,236	1,343
72		428	548	668	882	1,002	1,122	1,336	1,455
84		547	680	812	1,038	1,171	1,303	1,529	1,662
96		572	717	862	1,101	1,246	1,390	1,629	1,774
108		597	754	912	1,163	1,320	1,478	1,729	1,886

		Series 20							
		Overall Finished Width							
Length Up To		24	36	48	60	72	84	96	108
36		389	437	526	609	691	774	954	1,036
48		424	481	576	769	864	959	1,054	1,149
60		411	519	626	831	939	1,046	1,252	1,359
72		436	556	676	894	1,014	1,134	1,352	1,471
84		559	692	824	1,054	1,187	1,319	1,549	1,682
96		584	729	874	1,117	1,262	1,406	1,649	1,794
108		609	766	924	1,179	1,336	1,494	1,749	1,906

		Series 21							
		Overall Finished Width							
Length Up To		24	36	48	60	72	84	96	108
36		397	445	534	617	699	782	966	1,048
48		432	489	584	781	876	971	1,066	1,161
60		419	527	634	843	951	1,058	1,268	1,375
72		444	564	684	906	1,026	1,146	1,368	1,487
84		571	704	836	1,070	1,203	1,335	1,569	1,702
96		596	741	886	1,133	1,278	1,422	1,669	1,814
108		621	778	936	1,195	1,352	1,510	1,769	1,926

		Series 22							
		Overall Finished Width							
Length Up To		24	36	48	60	72	84	96	108
36		405	452	542	625	707	790	978	1,060
48		440	497	592	793	888	983	1,078	1,173
60		427	535	642	855	963	1,070	1,284	1,391
72		452	572	692	918	1,038	1,158	1,384	1,503
84		583	716	848	1,086	1,219	1,351	1,589	1,722
96		608	753	898	1,149	1,294	1,438	1,689	1,834
108		633	790	948	1,211	1,368	1,526	1,789	1,946

		Series 23							
		Overall Finished Width							
Length Up To		24	36	48	60	72	84	96	108
36		413	459	550	633	715	798	990	1,072
48		448	505	600	805	900	995	1,090	1,185
60		435	543	650	867	975	1,082	1,300	1,407
72		460	580	700	930	1,050	1,170	1,400	1,519
84		595	728	860	1,102	1,235	1,367	1,609	1,742
96		620	765	910	1,165	1,310	1,454	1,709	1,854
108		645	802	960	1,227	1,384	1,542	1,809	1,966

		Series 24							
		Overall Finished Width							
Length Up To		24	36	48	60	72	84	96	108
36		421	466	558	641	723	806	1,002	1,084
48		456	513	608	817	912	1,007	1,102	1,197
60		443	551	658	879	987	1,094	1,316	1,423
72		468	588	708	942	1,062	1,182	1,416	1,535
84		607	740	872	1,118	1,251	1,383	1,629	1,762
96		632	777	922	1,181	1,326	1,470	1,729	1,874
108		657	814	972	1,243	1,400	1,558	1,829	1,986

		Series 25							
		Overall Finished Width							
Length Up To		24	36	48	60	72	84	96	108
36		433	477	570	653	735	818	1,020	1,102
48		468	525	620	835	930	1,025	1,120	1,215
60		455	563	670	897	1,005	1,112	1,340	1,447
72		480	600	720	960	1,080	1,200	1,440	1,559
84		625	758	890	1,142	1,275	1,407	1,659	1,792
96		650	795	940	1,205	1,350	1,494	1,759	1,904
108		675	832	990	1,267	1,424	1,582	1,859	2,016

		Series 26							
		Overall Finished Width							
Length Up To		24	36	48	60	72	84	96	108
36		441	484	578	661	743	826	1,032	1,114
48		476	533	628	847	942	1,037	1,132	1,227
60		463	571	678	909	1,017	1,124	1,356	1,463
72		488	608	728	972	1,092	1,212	1,456	1,575
84		637	770	902	1,158	1,291	1,423	1,679	1,812
96		662	807	952	1,221	1,366	1,510	1,779	1,924
108		687	844	1,002	1,283	1,440	1,598	1,879	2,036

		Series 27							
		Overall Finished Width							
Length Up To		24	36	48	60	72	84	96	108
36		449	491	586	669	751	834	1,044	1,126
48		484	541	636	859	954	1,049	1,144	1,239
60		471	579	686	921	1,029	1,136	1,372	1,479
72		496	616	736	984	1,104	1,224	1,472	1,591
84		649	782	914	1,174	1,307	1,439	1,699	1,832
96		674	819	964	1,237	1,382	1,526	1,799	1,944
108		699	856	1,014	1,299	1,456	1,614	1,899	2,056

		Series 28							
		Overall Finished Width							
Length Up To		24	36	48	60	72	84	96	108
36		457	499	594	677	759	842	1,056	1,138
48		492	549	644	871	966	1,061	1,156	1,251
60		479	587	694	933	1,041	1,148	1,388	1,495
72		504	624	744	996	1,116	1,236	1,488	1,607
84		661	794	926	1,190	1,323	1,455	1,719	1,852
96		686	831	976	1,253	1,398	1,542	1,819	1,964
108		711	868	1,026	1,315	1,472	1,630	1,919	2,076

		Series 29							
		Overall Finished Width							
Length Up To		24	36	48	60	72	84	96	108
36		465	506	602	685	767	850	1,068	1,150
48		500	557	652	883	978	1,073	1,168	1,263
60		487	595	702	945	1,053	1,160	1,404	1,511
72		512	632	752	1,008	1,128	1,248	1,504	1,623
84		673	806	938	1,206	1,339	1,471	1,739	1,872
96		698	843	988	1,269	1,414	1,558	1,839	1,984
108		723	880	1,038	1,331	1,488	1,646	1,939	2,096

		Series 30							
		Overall Finished Width							
Length Up To		24	36	48	60	72	84	96	108
36		477	517	614	697	779	862	1,086	1,168
48		512	569	664	901	996	1,091	1,186	1,281
60		499	607	714	963	1,071	1,178	1,428	1,535
72		524	644	764	1,026	1,146	1,266	1,528	1,647
84		691	824	956	1,230	1,363	1,495	1,769	1,902
96		716	861	1,006	1,293	1,438	1,582	1,869	2,014
108		741	898	1,056	1,355	1,512	1,670	1,969	2,126

NOTE: For butterfly style shades, please specify the length option: to the bottom of the scallop, to the bottom of the weight bar OR straight bottom

FABRIC SHADES: Roman — Lined (Lining 01000)

Chart pricing includes board mount or headrail mount. Sizes and series numbers beyond what is listed in the charts below are available—please submit these quote requests via fax or email. **NOTE: For headrail mount:** manual—maximum width 107"; motorized—maximum width 70". For larger widths, please order board mount shades.

BUTTERFLY ROMAN SHADE

		Series 31							
		Overall Finished Width							
Length Up To		24	36	48	60	72	84	96	108
36		483	522	620	703	785	868	1,095	1,177
48		518	575	670	910	1,005	1,100	1,195	1,290
60		505	613	720	972	1,080	1,187	1,440	1,547
72		530	650	770	1,035	1,155	1,275	1,540	1,659
84		700	833	965	1,242	1,375	1,507	1,784	1,917
96		725	870	1,015	1,305	1,450	1,594	1,884	2,029
108		750	907	1,065	1,367	1,524	1,682	1,984	2,141

		Series 32							
		Overall Finished Width							
Length Up To		24	36	48	60	72	84	96	108
36		491	529	628	711	793	876	1,107	1,189
48		526	583	678	922	1,017	1,112	1,207	1,302
60		513	621	728	984	1,092	1,199	1,456	1,563
72		538	658	778	1,047	1,167	1,287	1,556	1,675
84		712	845	977	1,258	1,391	1,523	1,804	1,937
96		737	882	1,027	1,321	1,466	1,610	1,904	2,049
108		762	919	1,077	1,383	1,540	1,698	2,004	2,161

		Series 33							
		Overall Finished Width							
Length Up To		24	36	48	60	72	84	96	108
36		501	568	638	721	803	886	1,122	1,204
48		536	593	688	937	1,032	1,127	1,222	1,317
60		523	631	738	999	1,107	1,214	1,476	1,583
72		548	668	788	1,062	1,182	1,302	1,576	1,695
84		727	860	992	1,278	1,411	1,543	1,829	1,962
96		752	897	1,042	1,341	1,486	1,630	1,929	2,074
108		777	934	1,092	1,403	1,560	1,718	2,029	2,186

		Series 34							
		Overall Finished Width							
Length Up To		24	36	48	60	72	84	96	108
36		521	587	658	741	823	906	1,152	1,234
48		556	613	708	967	1,062	1,157	1,252	1,347
60		543	651	758	1,029	1,137	1,244	1,516	1,623
72		568	688	808	1,092	1,212	1,332	1,616	1,735
84		757	890	1,022	1,318	1,451	1,583	1,879	2,012
96		782	927	1,072	1,381	1,526	1,670	1,979	2,124
108		807	964	1,122	1,443	1,600	1,758	2,079	2,236

		Series 35							
		Overall Finished Width							
Length Up To		24	36	48	60	72	84	96	108
36		541	606	678	761	843	926	1,182	1,264
48		576	633	728	997	1,092	1,187	1,282	1,377
60		563	671	778	1,059	1,167	1,274	1,556	1,663
72		588	708	828	1,122	1,242	1,362	1,656	1,775
84		787	920	1,052	1,358	1,491	1,623	1,929	2,062
96		812	957	1,102	1,421	1,566	1,710	2,029	2,174
108		837	994	1,152	1,483	1,640	1,798	2,129	2,286

		Series 36							
		Overall Finished Width							
Length Up To		24	36	48	60	72	84	96	108
36		565	629	702	785	867	950	1,218	1,300
48		600	657	752	1,033	1,128	1,223	1,318	1,413
60		587	695	802	1,095	1,203	1,310	1,604	1,711
72		612	732	852	1,158	1,278	1,398	1,704	1,823
84		823	956	1,088	1,406	1,539	1,671	1,989	2,122
96		848	993	1,138	1,469	1,614	1,758	2,089	2,234
108		873	1,030	1,188	1,531	1,688	1,846	2,189	2,346

		Series 37							
		Overall Finished Width							
Length Up To		24	36	48	60	72	84	96	108
36		601	663	738	821	903	986	1,272	1,354
48		636	693	788	1,087	1,182	1,277	1,372	1,467
60		623	731	838	1,149	1,257	1,364	1,676	1,783
72		648	768	888	1,212	1,332	1,452	1,776	1,895
84		877	1,010	1,142	1,478	1,611	1,743	2,079	2,212
96		902	1,047	1,192	1,541	1,686	1,830	2,179	2,324
108		927	1,084	1,242	1,603	1,760	1,918	2,279	2,436

		Series 38							
		Overall Finished Width							
Length Up To		24	36	48	60	72	84	96	108
36		681	739	818	901	983	1,066	1,392	1,474
48		716	773	868	1,207	1,302	1,397	1,492	1,587
60		703	811	918	1,269	1,377	1,484	1,836	1,943
72		728	848	968	1,332	1,452	1,572	1,936	2,055
84		997	1,130	1,262	1,638	1,771	1,903	2,279	2,412
96		1,022	1,167	1,312	1,701	1,846	1,990	2,379	2,524
108		1,047	1,204	1,362	1,763	1,920	2,078	2,479	2,636

NOTE: For butterfly style shades, please specify the length option: to the bottom of the scallop, to the bottom of the weight bar OR straight bottom

FABRIC SHADES: Balloon — Unlined

Chart pricing includes board mount or headrail mount. Sizes and series numbers beyond what is listed below are available—please submit these quote requests via fax or email. **NOTE:** For headrail mount: manual—maximum width 100" and maximum length 72"; motorized—maximum width 67" and maximum length 72". For larger widths, please order board mount shades.

SHIRRED & BOX PLEATED BALLOON SHADE

		Series 07							
Length		Overall Finished Width							
Up To		24	36	48	60	72	84	96	108
36		237	334	390	492	574	676	758	839
48		272	345	438	553	668	783	876	970
60		254	381	508	635	741	868	974	1,101
72		279	418	557	696	835	974	1,092	1,231
84		324	475	627	778	929	1,080	1,211	1,362
96		348	512	675	839	1,002	1,166	1,308	1,492
108		373	548	724	921	1,096	1,272	1,426	1,602

		Series 08							
Length		Overall Finished Width							
Up To		24	36	48	60	72	84	96	108
36		247	344	405	512	594	701	783	864
48		282	360	453	573	693	813	906	1,000
60		264	396	528	660	766	898	1,004	1,136
72		289	433	577	721	865	1,009	1,127	1,271
84		339	495	652	808	964	1,120	1,251	1,407
96		363	532	700	869	1,037	1,206	1,348	1,542
108		388	568	749	956	1,136	1,317	1,471	1,652

		Series 09							
Length		Overall Finished Width							
Up To		24	36	48	60	72	84	96	108
36		255	352	417	528	610	721	803	884
48		290	372	465	589	713	837	930	1,024
60		272	408	544	680	786	922	1,028	1,164
72		297	445	593	741	889	1,037	1,155	1,303
84		351	511	672	832	992	1,152	1,283	1,443
96		375	548	720	893	1,065	1,238	1,380	1,582
108		400	584	769	984	1,168	1,353	1,507	1,692

		Series 10							
Length		Overall Finished Width							
Up To		24	36	48	60	72	84	96	108
36		263	360	429	544	626	741	823	904
48		298	384	477	605	733	861	954	1,048
60		280	420	560	700	806	946	1,052	1,192
72		305	457	609	761	913	1,065	1,183	1,335
84		363	527	692	856	1,020	1,184	1,315	1,479
96		387	564	740	917	1,093	1,270	1,412	1,622
108		412	600	789	1,012	1,200	1,389	1,543	1,732

		Series 11							
Length		Overall Finished Width							
Up To		24	36	48	60	72	84	96	108
36		271	368	441	560	642	761	843	924
48		306	396	489	621	753	885	978	1,072
60		288	432	576	720	826	970	1,076	1,220
72		313	469	625	781	937	1,093	1,211	1,367
84		375	543	712	880	1,048	1,216	1,347	1,515
96		399	580	760	941	1,121	1,302	1,444	1,662
108		424	616	809	1,040	1,232	1,425	1,579	1,772

		Series 12							
Length		Overall Finished Width							
Up To		24	36	48	60	72	84	96	108
36		279	376	453	576	658	781	863	944
48		314	408	501	637	773	909	1,002	1,096
60		296	444	592	740	846	994	1,100	1,248
72		321	481	641	801	961	1,121	1,239	1,399
84		387	559	732	904	1,076	1,248	1,379	1,551
96		411	596	780	965	1,149	1,334	1,476	1,702
108		436	632	829	1,068	1,264	1,461	1,615	1,812

		Series 13							
Length		Overall Finished Width							
Up To		24	36	48	60	72	84	96	108
36		287	384	465	592	674	801	883	964
48		322	420	513	653	793	933	1,026	1,120
60		304	456	608	760	866	1,018	1,124	1,276
72		329	493	657	821	985	1,149	1,267	1,431
84		399	575	752	928	1,104	1,280	1,411	1,587
96		423	612	800	989	1,177	1,366	1,508	1,742
108		448	648	849	1,096	1,296	1,497	1,651	1,852

		Series 14							
Length		Overall Finished Width							
Up To		24	36	48	60	72	84	96	108
36		295	392	477	608	690	821	903	984
48		330	432	525	669	813	957	1,050	1,144
60		312	468	624	780	886	1,042	1,148	1,304
72		337	505	673	841	1,009	1,177	1,295	1,463
84		411	591	772	952	1,132	1,312	1,443	1,623
96		435	628	820	1,013	1,205	1,398	1,540	1,782
108		460	664	869	1,124	1,328	1,533	1,687	1,892

		Series 15							
Length		Overall Finished Width							
Up To		24	36	48	60	72	84	96	108
36		303	400	489	624	706	841	923	1,004
48		338	444	537	685	833	981	1,074	1,168
60		320	480	640	800	906	1,066	1,172	1,332
72		345	517	689	861	1,033	1,205	1,323	1,495
84		423	607	792	976	1,160	1,344	1,475	1,659
96		447	644	840	1,037	1,233	1,430	1,572	1,822
108		472	680	889	1,152	1,360	1,569	1,723	1,932

		Series 16							
Length		Overall Finished Width							
Up To		24	36	48	60	72	84	96	108
36		311	408	501	640	722	861	943	1,024
48		346	456	549	701	853	1,005	1,098	1,192
60		328	492	656	820	926	1,090	1,196	1,360
72		353	529	705	881	1,057	1,233	1,351	1,527
84		435	623	812	1,000	1,188	1,376	1,507	1,695
96		459	660	860	1,061	1,261	1,462	1,604	1,862
108		484	696	909	1,180	1,392	1,605	1,759	1,972

		Series 17							
Length		Overall Finished Width							
Up To		24	36	48	60	72	84	96	108
36		319	416	513	656	738	881	963	1,044
48		354	468	561	717	873	1,029	1,122	1,216
60		336	504	672	840	946	1,114	1,220	1,388
72		361	541	721	901	1,081	1,261	1,379	1,559
84		447	639	832	1,024	1,216	1,408	1,539	1,731
96		471	676	880	1,085	1,289	1,494	1,636	1,902
108		496	712	929	1,208	1,424	1,641	1,795	2,012

		Series 18							
Length		Overall Finished Width							
Up To		24	36	48	60	72	84	96	108
36		327	424	525	672	754	901	983	1,064
48		362	480	573	733	893	1,053	1,146	1,240
60		344	516	688	860	966	1,138	1,244	1,416
72		369	553	737	921	1,105	1,289	1,407	1,591
84		459	655	852	1,048	1,244	1,440	1,571	1,767
96		483	692	900	1,109	1,317	1,526	1,668	1,942
108		508	728	949	1,236	1,456	1,677	1,831	2,052

NOTE: For balloon style shades, please specify the length option: to the bottom of the scallop, to the bottom of the weight bar OR straight bottom

FABRIC SHADES: Balloon — Unlined

Chart pricing includes board mount or headrail mount. Sizes and series numbers beyond what is listed below are available—please submit these quote requests via fax or email. **NOTE:** For headrail mount: manual—maximum width 100" and maximum length 72"; motorized—maximum width 67" and maximum length 72". For larger widths, please order board mount shades.

SHIRRED & BOX PLEATED BALLOON SHADE

		Series 19							
		Overall Finished Width							
Length Up To		24	36	48	60	72	84	96	108
36		335	432	537	688	770	921	1,003	1,084
48		370	492	585	749	913	1,077	1,170	1,264
60		352	528	704	880	986	1,162	1,268	1,444
72		377	565	753	941	1,129	1,317	1,435	1,623
84		471	671	872	1,072	1,272	1,472	1,603	1,803
96		495	708	920	1,133	1,345	1,558	1,700	1,982
108		520	744	969	1,264	1,488	1,713	1,867	2,092

		Series 20							
		Overall Finished Width							
Length Up To		24	36	48	60	72	84	96	108
36		343	440	549	704	786	941	1,023	1,104
48		378	504	597	765	933	1,101	1,194	1,288
60		360	540	720	900	1,006	1,186	1,292	1,472
72		385	577	769	961	1,153	1,345	1,463	1,655
84		483	687	892	1,096	1,300	1,504	1,635	1,839
96		507	724	940	1,157	1,373	1,590	1,732	2,022
108		532	760	989	1,292	1,520	1,749	1,903	2,132

		Series 21							
		Overall Finished Width							
Length Up To		24	36	48	60	72	84	96	108
36		351	448	561	720	802	961	1,043	1,124
48		386	516	609	781	953	1,125	1,218	1,312
60		368	552	736	920	1,026	1,210	1,316	1,500
72		393	589	785	981	1,177	1,373	1,491	1,687
84		495	703	912	1,120	1,328	1,536	1,667	1,875
96		519	740	960	1,181	1,401	1,622	1,764	2,062
108		544	776	1,009	1,320	1,552	1,785	1,939	2,172

		Series 22							
		Overall Finished Width							
Length Up To		24	36	48	60	72	84	96	108
36		359	456	573	736	818	981	1,063	1,144
48		394	528	621	797	973	1,149	1,242	1,336
60		376	564	752	940	1,046	1,234	1,340	1,528
72		401	601	801	1,001	1,201	1,401	1,519	1,719
84		507	719	932	1,144	1,356	1,568	1,699	1,911
96		531	756	980	1,205	1,429	1,654	1,796	2,102
108		556	792	1,029	1,348	1,584	1,821	1,975	2,212

		Series 23							
		Overall Finished Width							
Length Up To		24	36	48	60	72	84	96	108
36		367	464	585	752	834	1,001	1,083	1,164
48		402	540	633	813	993	1,173	1,266	1,360
60		384	576	768	960	1,066	1,258	1,364	1,556
72		409	613	817	1,021	1,225	1,429	1,547	1,751
84		519	735	952	1,168	1,384	1,600	1,731	1,947
96		543	772	1,000	1,229	1,457	1,686	1,828	2,142
108		568	808	1,049	1,376	1,616	1,857	2,011	2,252

		Series 24							
		Overall Finished Width							
Length Up To		24	36	48	60	72	84	96	108
36		375	472	597	768	850	1,021	1,103	1,184
48		410	552	645	829	1,013	1,197	1,290	1,384
60		392	588	784	980	1,086	1,282	1,388	1,584
72		417	625	833	1,041	1,249	1,457	1,575	1,783
84		531	751	972	1,192	1,412	1,632	1,763	1,983
96		555	788	1,020	1,253	1,485	1,718	1,860	2,182
108		580	824	1,069	1,404	1,648	1,893	2,047	2,292

		Series 25							
		Overall Finished Width							
Length Up To		24	36	48	60	72	84	96	108
36		387	484	615	792	874	1,051	1,133	1,214
48		422	570	663	853	1,043	1,233	1,326	1,420
60		404	606	808	1,010	1,116	1,318	1,424	1,626
72		429	643	857	1,071	1,285	1,499	1,617	1,831
84		549	775	1,002	1,228	1,454	1,680	1,811	2,037
96		573	812	1,050	1,289	1,527	1,766	1,908	2,242
108		598	848	1,099	1,446	1,696	1,947	2,101	2,352

		Series 26							
		Overall Finished Width							
Length Up To		24	36	48	60	72	84	96	108
36		395	492	627	808	890	1,071	1,153	1,234
48		430	582	675	869	1,063	1,257	1,350	1,444
60		412	618	824	1,030	1,136	1,342	1,448	1,654
72		437	655	873	1,091	1,309	1,527	1,645	1,863
84		561	791	1,022	1,252	1,482	1,712	1,843	2,073
96		585	828	1,070	1,313	1,555	1,798	1,940	2,282
108		610	864	1,119	1,474	1,728	1,983	2,137	2,392

		Series 27							
		Overall Finished Width							
Length Up To		24	36	48	60	72	84	96	108
36		403	500	639	824	906	1,091	1,173	1,254
48		438	594	687	885	1,083	1,281	1,374	1,468
60		420	630	840	1,050	1,156	1,366	1,472	1,682
72		445	667	889	1,111	1,333	1,555	1,673	1,895
84		573	807	1,042	1,276	1,510	1,744	1,875	2,109
96		597	844	1,090	1,337	1,583	1,830	1,972	2,322
108		622	880	1,139	1,502	1,760	2,019	2,173	2,432

		Series 28							
		Overall Finished Width							
Length Up To		24	36	48	60	72	84	96	108
36		411	508	651	840	922	1,111	1,193	1,274
48		446	606	699	901	1,103	1,305	1,398	1,492
60		428	642	856	1,070	1,176	1,390	1,496	1,710
72		453	679	905	1,131	1,357	1,583	1,701	1,927
84		585	823	1,062	1,300	1,538	1,776	1,907	2,145
96		609	860	1,110	1,361	1,611	1,862	2,004	2,362
108		634	896	1,159	1,530	1,792	2,055	2,209	2,472

		Series 29							
		Overall Finished Width							
Length Up To		24	36	48	60	72	84	96	108
36		419	516	663	856	938	1,131	1,213	1,294
48		454	618	711	917	1,123	1,329	1,422	1,516
60		436	654	872	1,090	1,196	1,414	1,520	1,738
72		461	691	921	1,151	1,381	1,611	1,729	1,959
84		597	839	1,082	1,324	1,566	1,808	1,939	2,181
96		621	876	1,130	1,385	1,639	1,894	2,036	2,402
108		646	912	1,179	1,558	1,824	2,091	2,245	2,512

		Series 30							
		Overall Finished Width							
Length Up To		24	36	48	60	72	84	96	108
36		431	528	681	880	962	1,161	1,243	1,324
48		466	636	729	941	1,153	1,365	1,458	1,552
60		448	672	896	1,120	1,226	1,450	1,556	1,780
72		473	709	945	1,181	1,417	1,653	1,771	2,007
84		615	863	1,112	1,360	1,608	1,856	1,987	2,235
96		639	900	1,160	1,421	1,681	1,942	2,084	2,462
108		664	936	1,209	1,600	1,872	2,145	2,299	2,572

NOTE: For balloon style shades, please specify the length option: to the bottom of the scallop, to the bottom of the weight bar OR straight bottom

FABRIC SHADES: Balloon — Unlined

Chart pricing includes board mount or headrail mount. Sizes and series numbers beyond what is listed below are available—please submit these quote requests via fax or email. **NOTE:** For headrail mount: manual—maximum width 100" and maximum length 72"; motorized—maximum width 67" and maximum length 72". For larger widths, please order board mount shades.

SHIRRED & BOX PLEATED BALLOON SHADE

		Series 31							
		Overall Finished Width							
Length Up To		24	36	48	60	72	84	96	108
36		437	534	690	892	974	1,176	1,258	1,339
48		472	645	738	953	1,168	1,383	1,476	1,570
60		454	681	908	1,135	1,241	1,468	1,574	1,801
72		479	718	957	1,196	1,435	1,674	1,792	2,031
84		624	875	1,127	1,378	1,629	1,880	2,011	2,262
96		648	912	1,175	1,439	1,702	1,966	2,108	2,492
108		673	948	1,224	1,621	1,896	2,172	2,326	2,602

		Series 32							
		Overall Finished Width							
Length Up To		24	36	48	60	72	84	96	108
36		445	542	702	908	990	1,196	1,278	1,359
48		480	657	750	969	1,188	1,407	1,500	1,594
60		462	693	924	1,155	1,261	1,492	1,598	1,829
72		487	730	973	1,216	1,459	1,702	1,820	2,063
84		636	891	1,147	1,402	1,657	1,912	2,043	2,298
96		660	928	1,195	1,463	1,730	1,998	2,140	2,532
108		685	964	1,244	1,649	1,928	2,208	2,362	2,642

		Series 33							
		Overall Finished Width							
Length Up To		24	36	48	60	72	84	96	108
36		455	552	717	928	1,010	1,221	1,303	1,384
48		490	672	765	989	1,213	1,437	1,530	1,624
60		472	708	944	1,180	1,286	1,522	1,628	1,864
72		497	745	993	1,241	1,489	1,737	1,855	2,103
84		651	911	1,172	1,432	1,692	1,952	2,083	2,343
96		675	948	1,220	1,493	1,765	2,038	2,180	2,582
108		700	984	1,269	1,684	1,968	2,253	2,407	2,692

		Series 34							
		Overall Finished Width							
Length Up To		24	36	48	60	72	84	96	108
36		475	572	747	968	1,050	1,271	1,353	1,434
48		510	702	795	1,029	1,263	1,497	1,590	1,684
60		492	738	984	1,230	1,336	1,582	1,688	1,934
72		517	775	1,033	1,291	1,549	1,807	1,925	2,183
84		681	951	1,222	1,492	1,762	2,032	2,163	2,433
96		705	988	1,270	1,553	1,835	2,118	2,260	2,682
108		730	1,024	1,319	1,754	2,048	2,343	2,497	2,792

		Series 35							
		Overall Finished Width							
Length Up To		24	36	48	60	72	84	96	108
36		495	592	777	1,008	1,090	1,321	1,403	1,484
48		530	732	825	1,069	1,313	1,557	1,650	1,744
60		512	768	1,024	1,280	1,386	1,642	1,748	2,004
72		537	805	1,073	1,341	1,609	1,877	1,995	2,263
84		711	991	1,272	1,552	1,832	2,112	2,243	2,523
96		735	1,028	1,320	1,613	1,905	2,198	2,340	2,782
108		760	1,064	1,369	1,824	2,128	2,433	2,587	2,892

		Series 36							
		Overall Finished Width							
Length Up To		24	36	48	60	72	84	96	108
36		519	616	813	1,056	1,138	1,381	1,463	1,544
48		554	768	861	1,117	1,373	1,629	1,722	1,816
60		536	804	1,072	1,340	1,446	1,714	1,820	2,088
72		561	841	1,121	1,401	1,681	1,961	2,079	2,359
84		747	1,039	1,332	1,624	1,916	2,208	2,339	2,631
96		771	1,076	1,380	1,685	1,989	2,294	2,436	2,902
108		796	1,112	1,429	1,908	2,224	2,541	2,695	3,012

		Series 37							
		Overall Finished Width							
Length Up To		24	36	48	60	72	84	96	108
36		555	652	867	1,128	1,210	1,471	1,553	1,634
48		590	822	915	1,189	1,463	1,737	1,830	1,924
60		572	858	1,144	1,430	1,536	1,822	1,928	2,214
72		597	895	1,193	1,491	1,789	2,087	2,205	2,503
84		801	1,111	1,422	1,732	2,042	2,352	2,483	2,793
96		825	1,148	1,470	1,793	2,115	2,438	2,580	3,082
108		850	1,184	1,519	2,034	2,368	2,703	2,857	3,192

		Series 38							
		Overall Finished Width							
Length Up To		24	36	48	60	72	84	96	108
36		635	732	987	1,288	1,370	1,671	1,753	1,834
48		670	942	1,035	1,349	1,663	1,977	2,070	2,164
60		652	978	1,304	1,630	1,736	2,062	2,168	2,494
72		677	1,015	1,353	1,691	2,029	2,367	2,485	2,823
84		921	1,271	1,622	1,972	2,322	2,672	2,803	3,153
96		945	1,308	1,670	2,033	2,395	2,758	2,900	3,482
108		970	1,344	1,719	2,314	2,688	3,063	3,217	3,592

NOTE: For balloon style shades, please specify the length option: to the bottom of the scallop, to the bottom of the weight bar OR straight bottom

FABRIC SHADES: Balloon — Lined (Lining 01000)

Chart pricing includes board mount or headrail mount. Sizes and series numbers beyond what is listed below are available—please submit these quote requests via fax or email. **NOTE:** For headrail mount: manual—maximum width 78" and maximum length 72"; motorized—maximum width 52" and maximum length 72". For larger widths, please order board mount shades.

SHIRRED & BOX PLEATED BALLOON SHADE

		Series 07							
		Overall Finished Width							
Length Up To		24	36	48	60	72	84	96	108
36		297	401	479	610	696	827	912	998
48		336	434	533	678	822	967	1,066	1,166
60		317	475	633	791	904	1,062	1,175	1,333
72		344	516	687	859	1,031	1,203	1,329	1,501
84		416	602	787	972	1,158	1,343	1,483	1,669
96		443	642	841	1,040	1,239	1,438	1,592	1,836
108		471	683	896	1,153	1,366	1,579	1,746	1,959

		Series 08							
		Overall Finished Width							
Length Up To		24	36	48	60	72	84	96	108
36		307	411	494	630	716	852	937	1,023
48		346	449	548	698	847	997	1,096	1,196
60		327	490	653	816	929	1,092	1,205	1,368
72		354	531	707	884	1,061	1,238	1,364	1,541
84		431	622	812	1,002	1,193	1,383	1,523	1,714
96		458	662	866	1,070	1,274	1,478	1,632	1,886
108		486	703	921	1,188	1,406	1,624	1,791	2,009

		Series 09							
		Overall Finished Width							
Length Up To		24	36	48	60	72	84	96	108
36		315	419	506	646	732	872	957	1,043
48		354	461	560	714	867	1,021	1,120	1,220
60		335	502	669	836	949	1,116	1,229	1,396
72		362	543	723	904	1,085	1,266	1,392	1,573
84		443	638	832	1,026	1,221	1,415	1,555	1,750
96		470	678	886	1,094	1,302	1,510	1,664	1,926
108		498	719	941	1,216	1,438	1,660	1,827	2,049

		Series 10							
		Overall Finished Width							
Length Up To		24	36	48	60	72	84	96	108
36		323	427	518	662	748	892	977	1,063
48		362	473	572	730	887	1,045	1,144	1,244
60		343	514	685	856	969	1,140	1,253	1,424
72		370	555	739	924	1,109	1,294	1,420	1,605
84		455	654	852	1,050	1,249	1,447	1,587	1,786
96		482	694	906	1,118	1,330	1,542	1,696	1,966
108		510	735	961	1,244	1,470	1,696	1,863	2,089

		Series 11							
		Overall Finished Width							
Length Up To		24	36	48	60	72	84	96	108
36		331	435	530	678	764	912	997	1,083
48		370	485	584	746	907	1,069	1,168	1,268
60		351	526	701	876	989	1,164	1,277	1,452
72		378	567	755	944	1,133	1,322	1,448	1,637
84		467	670	872	1,074	1,277	1,479	1,619	1,822
96		494	710	926	1,142	1,358	1,574	1,728	2,006
108		522	751	981	1,272	1,502	1,732	1,899	2,129

		Series 12							
		Overall Finished Width							
Length Up To		24	36	48	60	72	84	96	108
36		339	443	542	694	780	932	1,017	1,103
48		378	497	596	762	927	1,093	1,192	1,292
60		359	538	717	896	1,009	1,188	1,301	1,480
72		386	579	771	964	1,157	1,350	1,476	1,669
84		479	686	892	1,098	1,305	1,511	1,651	1,858
96		506	726	946	1,166	1,386	1,606	1,760	2,046
108		534	767	1,001	1,300	1,534	1,768	1,935	2,169

		Series 13							
		Overall Finished Width							
Length Up To		24	36	48	60	72	84	96	108
36		347	451	554	710	796	952	1,037	1,123
48		386	509	608	778	947	1,117	1,216	1,316
60		367	550	733	916	1,029	1,212	1,325	1,508
72		394	591	787	984	1,181	1,378	1,504	1,701
84		491	702	912	1,122	1,333	1,543	1,683	1,894
96		518	742	966	1,190	1,414	1,638	1,792	2,086
108		546	783	1,021	1,328	1,566	1,804	1,971	2,209

		Series 14							
		Overall Finished Width							
Length Up To		24	36	48	60	72	84	96	108
36		355	459	566	726	812	972	1,057	1,143
48		394	521	620	794	967	1,141	1,240	1,340
60		375	562	749	936	1,049	1,236	1,349	1,536
72		402	603	803	1,004	1,205	1,406	1,532	1,733
84		503	718	932	1,146	1,361	1,575	1,715	1,930
96		530	758	986	1,214	1,442	1,670	1,824	2,126
108		558	799	1,041	1,356	1,598	1,840	2,007	2,249

		Series 15							
		Overall Finished Width							
Length Up To		24	36	48	60	72	84	96	108
36		363	467	578	742	828	992	1,077	1,163
48		402	533	632	810	987	1,165	1,264	1,364
60		383	574	765	956	1,069	1,260	1,373	1,564
72		410	615	819	1,024	1,229	1,434	1,560	1,765
84		515	734	952	1,170	1,389	1,607	1,747	1,966
96		542	774	1,006	1,238	1,470	1,702	1,856	2,166
108		570	815	1,061	1,384	1,630	1,876	2,043	2,289

		Series 16							
		Overall Finished Width							
Length Up To		24	36	48	60	72	84	96	108
36		371	475	590	758	844	1,012	1,097	1,183
48		410	545	644	826	1,007	1,189	1,288	1,388
60		391	586	781	976	1,089	1,284	1,397	1,592
72		418	627	835	1,044	1,253	1,462	1,588	1,797
84		527	750	972	1,194	1,417	1,639	1,779	2,002
96		554	790	1,026	1,262	1,498	1,734	1,888	2,206
108		582	831	1,081	1,412	1,662	1,912	2,079	2,329

		Series 17							
		Overall Finished Width							
Length Up To		24	36	48	60	72	84	96	108
36		379	483	602	774	860	1,032	1,117	1,203
48		418	557	656	842	1,027	1,213	1,312	1,412
60		399	598	797	996	1,109	1,308	1,421	1,620
72		426	639	851	1,064	1,277	1,490	1,616	1,829
84		539	766	992	1,218	1,445	1,671	1,811	2,038
96		566	806	1,046	1,286	1,526	1,766	1,920	2,246
108		594	847	1,101	1,440	1,694	1,948	2,115	2,369

		Series 18							
		Overall Finished Width							
Length Up To		24	36	48	60	72	84	96	108
36		387	491	614	790	876	1,052	1,137	1,223
48		426	569	668	858	1,047	1,237	1,336	1,436
60		407	610	813	1,016	1,129	1,332	1,445	1,648
72		434	651	867	1,084	1,301	1,518	1,644	1,861
84		551	782	1,012	1,242	1,473	1,703	1,843	2,074
96		578	822	1,066	1,310	1,554	1,798	1,952	2,286
108		606	863	1,121	1,468	1,726	1,984	2,151	2,409

NOTE: For balloon style shades, please specify the length option: to the bottom of the scallop, to the bottom of the weight bar OR straight bottom

FABRIC SHADES: Balloon — Lined (Lining 01000)

Chart pricing includes board mount or headrail mount. Sizes and series numbers beyond what is listed below are available—please submit these quote requests via fax or email. **NOTE:** For headrail mount: manual—maximum width 78" and maximum length 72"; motorized—maximum width 52" and maximum length 72". For larger widths, please order board mount shades.

SHIRRED & BOX PLEATED BALLOON SHADE

		Series 19							
		Overall Finished Width							
Length Up To		24	36	48	60	72	84	96	108
36		395	499	626	806	892	1,072	1,157	1,243
48		434	581	680	874	1,067	1,261	1,360	1,460
60		415	622	829	1,036	1,149	1,356	1,469	1,676
72		442	663	883	1,104	1,325	1,546	1,672	1,893
84		563	798	1,032	1,266	1,501	1,735	1,875	2,110
96		590	838	1,086	1,334	1,582	1,830	1,984	2,326
108		618	879	1,141	1,496	1,758	2,020	2,187	2,449

		Series 20							
		Overall Finished Width							
Length Up To		24	36	48	60	72	84	96	108
36		403	507	638	822	908	1,092	1,177	1,263
48		442	593	692	890	1,087	1,285	1,384	1,484
60		423	634	845	1,056	1,169	1,380	1,493	1,704
72		450	675	899	1,124	1,349	1,574	1,700	1,925
84		575	814	1,052	1,290	1,529	1,767	1,907	2,146
96		602	854	1,106	1,358	1,610	1,862	2,016	2,366
108		630	895	1,161	1,524	1,790	2,056	2,223	2,489

		Series 21							
		Overall Finished Width							
Length Up To		24	36	48	60	72	84	96	108
36		411	515	650	838	924	1,112	1,197	1,283
48		450	605	704	906	1,107	1,309	1,408	1,508
60		431	646	861	1,076	1,189	1,404	1,517	1,732
72		458	687	915	1,144	1,373	1,602	1,728	1,957
84		587	830	1,072	1,314	1,557	1,799	1,939	2,182
96		614	870	1,126	1,382	1,638	1,894	2,048	2,406
108		642	911	1,181	1,552	1,822	2,092	2,259	2,529

		Series 22							
		Overall Finished Width							
Length Up To		24	36	48	60	72	84	96	108
36		419	523	662	854	940	1,132	1,217	1,303
48		458	617	716	922	1,127	1,333	1,432	1,532
60		439	658	877	1,096	1,209	1,428	1,541	1,760
72		466	699	931	1,164	1,397	1,630	1,756	1,989
84		599	846	1,092	1,338	1,585	1,831	1,971	2,218
96		626	886	1,146	1,406	1,666	1,926	2,080	2,446
108		654	927	1,201	1,580	1,854	2,128	2,295	2,569

		Series 23							
		Overall Finished Width							
Length Up To		24	36	48	60	72	84	96	108
36		427	531	674	870	956	1,152	1,237	1,323
48		466	629	728	938	1,147	1,357	1,456	1,556
60		447	670	893	1,116	1,229	1,452	1,565	1,788
72		474	711	947	1,184	1,421	1,658	1,784	2,021
84		611	862	1,112	1,362	1,613	1,863	2,003	2,254
96		638	902	1,166	1,430	1,694	1,958	2,112	2,486
108		666	943	1,221	1,608	1,886	2,164	2,331	2,609

		Series 24							
		Overall Finished Width							
Length Up To		24	36	48	60	72	84	96	108
36		435	539	686	886	972	1,172	1,257	1,343
48		474	641	740	954	1,167	1,381	1,480	1,580
60		455	682	909	1,136	1,249	1,476	1,589	1,816
72		482	723	963	1,204	1,445	1,686	1,812	2,053
84		623	878	1,132	1,386	1,641	1,895	2,035	2,290
96		650	918	1,186	1,454	1,722	1,990	2,144	2,526
108		678	959	1,241	1,636	1,918	2,200	2,367	2,649

		Series 25							
		Overall Finished Width							
Length Up To		24	36	48	60	72	84	96	108
36		447	551	704	910	996	1,202	1,287	1,373
48		486	659	758	978	1,197	1,417	1,516	1,616
60		467	700	933	1,166	1,279	1,512	1,625	1,858
72		494	741	987	1,234	1,481	1,728	1,854	2,101
84		641	902	1,162	1,422	1,683	1,943	2,083	2,344
96		668	942	1,216	1,490	1,764	2,038	2,192	2,586
108		696	983	1,271	1,678	1,966	2,254	2,421	2,709

		Series 26							
		Overall Finished Width							
Length Up To		24	36	48	60	72	84	96	108
36		455	559	716	926	1,012	1,222	1,307	1,393
48		494	671	770	994	1,217	1,441	1,540	1,640
60		475	712	949	1,186	1,299	1,536	1,649	1,886
72		502	753	1,003	1,254	1,505	1,756	1,882	2,133
84		653	918	1,182	1,446	1,711	1,975	2,115	2,380
96		680	958	1,236	1,514	1,792	2,070	2,224	2,626
108		708	999	1,291	1,706	1,998	2,290	2,457	2,749

		Series 27							
		Overall Finished Width							
Length Up To		24	36	48	60	72	84	96	108
36		463	567	728	942	1,028	1,242	1,327	1,413
48		502	683	782	1,010	1,237	1,465	1,564	1,664
60		483	724	965	1,206	1,319	1,560	1,673	1,914
72		510	765	1,019	1,274	1,529	1,784	1,910	2,165
84		665	934	1,202	1,470	1,739	2,007	2,147	2,416
96		692	974	1,256	1,538	1,820	2,102	2,256	2,666
108		720	1,015	1,311	1,734	2,030	2,326	2,493	2,789

		Series 28							
		Overall Finished Width							
Length Up To		24	36	48	60	72	84	96	108
36		471	575	740	958	1,044	1,262	1,347	1,433
48		510	695	794	1,026	1,257	1,489	1,588	1,688
60		491	736	981	1,226	1,339	1,584	1,697	1,942
72		518	777	1,035	1,294	1,553	1,812	1,938	2,197
84		677	950	1,222	1,494	1,767	2,039	2,179	2,452
96		704	990	1,276	1,562	1,848	2,134	2,288	2,706
108		732	1,031	1,331	1,762	2,062	2,362	2,529	2,829

		Series 29							
		Overall Finished Width							
Length Up To		24	36	48	60	72	84	96	108
36		479	583	752	974	1,060	1,282	1,367	1,453
48		518	707	806	1,042	1,277	1,513	1,612	1,712
60		499	748	997	1,246	1,359	1,608	1,721	1,970
72		526	789	1,051	1,314	1,577	1,840	1,966	2,229
84		689	966	1,242	1,518	1,795	2,071	2,211	2,488
96		716	1,006	1,296	1,586	1,876	2,166	2,320	2,746
108		744	1,047	1,351	1,790	2,094	2,398	2,565	2,869

		Series 30							
		Overall Finished Width							
Length Up To		24	36	48	60	72	84	96	108
36		491	595	770	998	1,084	1,312	1,397	1,483
48		530	725	824	1,066	1,307	1,549	1,648	1,748
60		511	766	1,021	1,276	1,389	1,644	1,757	2,012
72		538	807	1,075	1,344	1,613	1,882	2,008	2,277
84		707	990	1,272	1,554	1,837	2,119	2,259	2,542
96		734	1,030	1,326	1,622	1,918	2,214	2,368	2,806
108		762	1,071	1,381	1,832	2,142	2,452	2,619	2,929

NOTE: For balloon style shades, please specify the length option: to the bottom of the scallop, to the bottom of the weight bar OR straight bottom

FABRIC SHADES: Balloon — Lined (Lining 01000)

Chart pricing includes board mount or headrail mount. Sizes and series numbers beyond what is listed below are available—please submit these quote requests via fax or email. **NOTE:** For headrail mount: manual—maximum width 78" and maximum length 72"; motorized—maximum width 52" and maximum length 72". For larger widths, please order board mount shades.

SHIRRED & BOX PLEATED BALLOON SHADE

		Series 31							
		Overall Finished Width							
Length Up To		24	36	48	60	72	84	96	108
36		497	601	779	1,010	1,096	1,327	1,412	1,498
48		536	734	833	1,078	1,322	1,567	1,666	1,766
60		517	775	1,033	1,291	1,404	1,662	1,775	2,033
72		544	816	1,087	1,359	1,631	1,903	2,029	2,301
84		716	1,002	1,287	1,572	1,858	2,143	2,283	2,569
96		743	1,042	1,341	1,640	1,939	2,238	2,392	2,836
108		771	1,083	1,396	1,853	2,166	2,479	2,646	2,959

		Series 32							
		Overall Finished Width							
Length Up To		24	36	48	60	72	84	96	108
36		505	609	791	1,026	1,112	1,347	1,432	1,518
48		544	746	845	1,094	1,342	1,591	1,690	1,790
60		525	787	1,049	1,311	1,424	1,686	1,799	2,061
72		552	828	1,103	1,379	1,655	1,931	2,057	2,333
84		728	1,018	1,307	1,596	1,886	2,175	2,315	2,605
96		755	1,058	1,361	1,664	1,967	2,270	2,424	2,876
108		783	1,099	1,416	1,881	2,198	2,515	2,682	2,999

		Series 33							
		Overall Finished Width							
Length Up To		24	36	48	60	72	84	96	108
36		515	619	806	1,046	1,132	1,372	1,457	1,543
48		554	761	860	1,114	1,367	1,621	1,720	1,820
60		535	802	1,069	1,336	1,449	1,716	1,829	2,096
72		562	843	1,123	1,404	1,685	1,966	2,092	2,373
84		743	1,038	1,332	1,626	1,921	2,215	2,355	2,650
96		770	1,078	1,386	1,694	2,002	2,310	2,464	2,926
108		798	1,119	1,441	1,916	2,238	2,560	2,727	3,049

		Series 34							
		Overall Finished Width							
Length Up To		24	36	48	60	72	84	96	108
36		535	639	836	1,086	1,172	1,422	1,507	1,593
48		574	791	890	1,154	1,417	1,681	1,780	1,880
60		555	832	1,109	1,386	1,499	1,776	1,889	2,166
72		582	873	1,163	1,454	1,745	2,036	2,162	2,453
84		773	1,078	1,382	1,686	1,991	2,295	2,435	2,740
96		800	1,118	1,436	1,754	2,072	2,390	2,544	3,026
108		828	1,159	1,491	1,986	2,318	2,650	2,817	3,149

		Series 35							
		Overall Finished Width							
Length Up To		24	36	48	60	72	84	96	108
36		555	659	866	1,126	1,212	1,472	1,557	1,643
48		594	821	920	1,194	1,467	1,741	1,840	1,940
60		575	862	1,149	1,436	1,549	1,836	1,949	2,236
72		602	903	1,203	1,504	1,805	2,106	2,232	2,533
84		803	1,118	1,432	1,746	2,061	2,375	2,515	2,830
96		830	1,158	1,486	1,814	2,142	2,470	2,624	3,126
108		858	1,199	1,541	2,056	2,398	2,740	2,907	3,249

		Series 36							
		Overall Finished Width							
Length Up To		24	36	48	60	72	84	96	108
36		579	683	902	1,174	1,260	1,532	1,617	1,703
48		618	857	956	1,242	1,527	1,813	1,912	2,012
60		599	898	1,197	1,496	1,609	1,908	2,021	2,320
72		626	939	1,251	1,564	1,877	2,190	2,316	2,629
84		839	1,166	1,492	1,818	2,145	2,471	2,611	2,938
96		866	1,206	1,546	1,886	2,226	2,566	2,720	3,246
108		894	1,247	1,601	2,140	2,494	2,848	3,015	3,369

		Series 37							
		Overall Finished Width							
Length Up To		24	36	48	60	72	84	96	108
36		615	719	956	1,246	1,332	1,622	1,707	1,793
48		654	911	1,010	1,314	1,617	1,921	2,020	2,120
60		635	952	1,269	1,586	1,699	2,016	2,129	2,446
72		662	993	1,323	1,654	1,985	2,316	2,442	2,773
84		893	1,238	1,582	1,926	2,271	2,615	2,755	3,100
96		920	1,278	1,636	1,994	2,352	2,710	2,864	3,426
108		948	1,319	1,691	2,266	2,638	3,010	3,177	3,549

		Series 38							
		Overall Finished Width							
Length Up To		24	36	48	60	72	84	96	108
36		695	799	1,076	1,406	1,492	1,822	1,907	1,993
48		734	1,031	1,130	1,474	1,817	2,161	2,260	2,360
60		715	1,072	1,429	1,786	1,899	2,256	2,369	2,726
72		742	1,113	1,483	1,854	2,225	2,596	2,722	3,093
84		1,013	1,398	1,782	2,166	2,551	2,935	3,075	3,460
96		1,040	1,438	1,836	2,234	2,632	3,030	3,184	3,826
108		1,068	1,479	1,891	2,546	2,958	3,370	3,537	3,949

NOTE: For balloon style shades, please specify the length option: to the bottom of the scallop, to the bottom of the weight bar OR straight bottom

NARROW-WIDTH FABRIC (50" – 60")

PRICING CHARTS

NOTE: Our price charts make it easy to estimate the price of your window treatment based on standard widths and lengths. If your measurements fall in-between two sizes, your actual price (stated on the order confirmation) will be based on the EXACT width and length of your order.

Pricing Charts do NOT reflect the additional yardage that may be required for pattern matching.

Shipping charges will be added at a \$20 flat-rate per order, with the exception of oversized/overweight shipments requiring LTL (see page 249 in this guide for additional information).

PLEATED DRAPERIES: 2.5 Fullness — Unlined

Sizes and series numbers beyond what is listed in the charts below are available—please submit these quote requests via fax or email.

Number of Widths							
2	3	4	5	6	7	8	

Number of Widths							
2	3	4	5	6	7	8	

Series 7								
Length Up To	Overall Finished Width							
	42	63	84	105	126	147	168	
36	135	212	251	329	386	463	502	
48	156	233	293	350	428	505	565	
72	177	275	335	434	512	610	670	
84	198	296	377	455	554	652	733	
108	219	338	419	539	638	757	838	
120	240	359	461	560	680	799	901	
144	261	401	503	644	764	904	1,006	

Series 8								
Length Up To	Overall Finished Width							
	42	63	84	105	126	147	168	
36	150	237	281	369	431	518	562	
48	176	263	333	395	483	570	640	
72	202	315	385	499	587	700	770	
84	228	341	437	525	639	752	848	
108	254	393	489	629	743	882	978	
120	280	419	541	655	795	934	1,056	
144	306	471	593	759	899	1,064	1,186	

Series 9								
Length Up To	Overall Finished Width							
	42	63	84	105	126	147	168	
36	162	257	305	401	467	562	610	
48	192	287	365	431	527	622	700	
72	222	347	425	551	647	772	850	
84	252	377	485	581	707	832	940	
108	282	437	545	701	827	982	1,090	
120	312	467	605	731	887	1,042	1,180	
144	342	527	665	851	1,007	1,192	1,330	

Series 10								
Length Up To	Overall Finished Width							
	42	63	84	105	126	147	168	
36	174	277	329	433	503	606	658	
48	208	311	397	467	571	674	760	
72	242	379	465	603	707	844	930	
84	276	413	533	637	775	912	1,032	
108	310	481	601	773	911	1,082	1,202	
120	344	515	669	807	979	1,150	1,304	
144	378	583	737	943	1,115	1,320	1,474	

Series 11								
Length Up To	Overall Finished Width							
	42	63	84	105	126	147	168	
36	186	297	353	465	539	650	706	
48	224	335	429	503	615	726	820	
72	262	411	505	655	767	916	1,010	
84	300	449	581	693	843	992	1,124	
108	338	525	657	845	995	1,182	1,314	
120	376	563	733	883	1,071	1,258	1,428	
144	414	639	809	1,035	1,223	1,448	1,618	

Series 12								
Length Up To	Overall Finished Width							
	42	63	84	105	126	147	168	
36	198	317	377	497	575	694	754	
48	240	359	461	539	659	778	880	
72	282	443	545	707	827	988	1,090	
84	324	485	629	749	911	1,072	1,216	
108	366	569	713	917	1,079	1,282	1,426	
120	408	611	797	959	1,163	1,366	1,552	
144	450	695	881	1,127	1,331	1,576	1,762	

Series 13								
Length Up To	Overall Finished Width							
	42	63	84	105	126	147	168	
36	210	337	401	529	611	738	802	
48	256	383	493	575	703	830	940	
72	302	475	585	759	887	1,060	1,170	
84	348	521	677	805	979	1,152	1,308	
108	394	613	769	989	1,163	1,382	1,538	
120	440	659	861	1,035	1,255	1,474	1,676	
144	486	751	953	1,219	1,439	1,704	1,906	

Series 14								
Length Up To	Overall Finished Width							
	42	63	84	105	126	147	168	
36	222	357	425	561	647	782	850	
48	272	407	525	611	747	882	1,000	
72	322	507	625	811	947	1,132	1,250	
84	372	557	725	861	1,047	1,232	1,400	
108	422	657	825	1,061	1,247	1,482	1,650	
120	472	707	925	1,111	1,347	1,582	1,800	
144	522	807	1,025	1,311	1,547	1,832	2,050	

Series 15								
Length Up To	Overall Finished Width							
	42	63	84	105	126	147	168	
36	234	377	449	593	683	826	898	
48	288	431	557	647	791	934	1,060	
72	342	539	665	863	1,007	1,204	1,330	
84	396	593	773	917	1,115	1,312	1,492	
108	450	701	881	1,133	1,331	1,582	1,762	
120	504	755	989	1,187	1,439	1,690	1,924	
144	558	863	1,097	1,403	1,655	1,960	2,194	

Series 16								
Length Up To	Overall Finished Width							
	42	63	84	105	126	147	168	
36	246	397	473	625	719	870	946	
48	304	455	589	683	835	986	1,120	
72	362	571	705	915	1,067	1,276	1,410	
84	420	629	821	973	1,183	1,392	1,584	
108	478	745	937	1,205	1,415	1,682	1,874	
120	536	803	1,053	1,263	1,531	1,798	2,048	
144	594	919	1,169	1,495	1,763	2,088	2,338	

PLEATED DRAPERIES: 2.5 Fullness — Unlined

Sizes and series numbers beyond what is listed in the charts below are available—please submit these quote requests via fax or email.

Number of Widths							
2	3	4	5	6	7	8	

Number of Widths							
2	3	4	5	6	7	8	

Series 17

Length Up To	Overall Finished Width						
	42	63	84	105	126	147	168
36	258	417	497	657	755	914	994
48	320	479	621	719	879	1,038	1,180
72	382	603	745	967	1,127	1,348	1,490
84	444	665	869	1,029	1,251	1,472	1,676
108	506	789	993	1,277	1,499	1,782	1,986
120	568	851	1,117	1,339	1,623	1,906	2,172
144	630	975	1,241	1,587	1,871	2,216	2,482

Series 18

Length Up To	Overall Finished Width						
	42	63	84	105	126	147	168
36	270	437	521	689	791	958	1,042
48	336	503	653	755	923	1,090	1,240
72	402	635	785	1,019	1,187	1,420	1,570
84	468	701	917	1,085	1,319	1,552	1,768
108	534	833	1,049	1,349	1,583	1,882	2,098
120	600	899	1,181	1,415	1,715	2,014	2,296
144	666	1,031	1,313	1,679	1,979	2,344	2,626

Series 19

Length Up To	Overall Finished Width						
	42	63	84	105	126	147	168
36	282	457	545	721	827	1,002	1,090
48	352	527	685	791	967	1,142	1,300
72	422	667	825	1,071	1,247	1,492	1,650
84	492	737	965	1,141	1,387	1,632	1,860
108	562	877	1,105	1,421	1,667	1,982	2,210
120	632	947	1,245	1,491	1,807	2,122	2,420
144	702	1,087	1,385	1,771	2,087	2,472	2,770

Series 20

Length Up To	Overall Finished Width						
	42	63	84	105	126	147	168
36	294	477	569	753	863	1,046	1,138
48	368	551	717	827	1,011	1,194	1,360
72	442	699	865	1,123	1,307	1,564	1,730
84	516	773	1,013	1,197	1,455	1,712	1,952
108	590	921	1,161	1,493	1,751	2,082	2,322
120	664	995	1,309	1,567	1,899	2,230	2,544
144	738	1,143	1,457	1,863	2,195	2,600	2,914

Series 21

Length Up To	Overall Finished Width						
	42	63	84	105	126	147	168
36	306	497	593	785	899	1,090	1,186
48	384	575	749	863	1,055	1,246	1,420
72	462	731	905	1,175	1,367	1,636	1,810
84	540	809	1,061	1,253	1,523	1,792	2,044
108	618	965	1,217	1,565	1,835	2,182	2,434
120	696	1,043	1,373	1,643	1,991	2,338	2,668
144	774	1,199	1,529	1,955	2,303	2,728	3,058

Series 22

Length Up To	Overall Finished Width						
	42	63	84	105	126	147	168
36	318	517	617	817	935	1,134	1,234
48	400	599	781	899	1,099	1,298	1,480
72	482	763	945	1,227	1,427	1,708	1,890
84	564	845	1,109	1,309	1,591	1,872	2,136
108	646	1,009	1,273	1,637	1,919	2,282	2,546
120	728	1,091	1,437	1,719	2,083	2,446	2,792
144	810	1,255	1,601	2,047	2,411	2,856	3,202

Series 23

Length Up To	Overall Finished Width						
	42	63	84	105	126	147	168
36	330	537	641	849	971	1,178	1,282
48	416	623	813	935	1,143	1,350	1,540
72	502	795	985	1,279	1,487	1,780	1,970
84	588	881	1,157	1,365	1,659	1,952	2,228
108	674	1,053	1,329	1,709	2,003	2,382	2,658
120	760	1,139	1,501	1,795	2,175	2,554	2,916
144	846	1,311	1,673	2,139	2,519	2,984	3,346

Series 24

Length Up To	Overall Finished Width						
	42	63	84	105	126	147	168
36	342	557	665	881	1,007	1,222	1,330
48	432	647	845	971	1,187	1,402	1,600
72	522	827	1,025	1,331	1,547	1,852	2,050
84	612	917	1,205	1,421	1,727	2,032	2,320
108	702	1,097	1,385	1,781	2,087	2,482	2,770
120	792	1,187	1,565	1,871	2,267	2,662	3,040
144	882	1,367	1,745	2,231	2,627	3,112	3,490

Series 25

Length Up To	Overall Finished Width						
	42	63	84	105	126	147	168
36	360	587	701	929	1,061	1,288	1,402
48	456	683	893	1,025	1,253	1,480	1,690
72	552	875	1,085	1,409	1,637	1,960	2,170
84	648	971	1,277	1,505	1,829	2,152	2,458
108	744	1,163	1,469	1,889	2,213	2,632	2,938
120	840	1,259	1,661	1,985	2,405	2,824	3,226
144	936	1,451	1,853	2,369	2,789	3,304	3,706

Series 26

Length Up To	Overall Finished Width						
	42	63	84	105	126	147	168
36	372	607	725	961	1,097	1,332	1,450
48	472	707	925	1,061	1,297	1,532	1,750
72	572	907	1,125	1,461	1,697	2,032	2,250
84	672	1,007	1,325	1,561	1,897	2,232	2,550
108	772	1,207	1,525	1,961	2,297	2,732	3,050
120	872	1,307	1,725	2,061	2,497	2,932	3,350
144	972	1,507	1,925	2,461	2,897	3,432	3,850

PLEATED DRAPERIES: 2.5 Fullness — Lined (Lining 01000)

Sizes and series numbers beyond what is listed in the charts below are available—please submit these quote requests via fax or email.

Number of Widths							
2	3	4	5	6	7	8	

Number of Widths							
2	3	4	5	6	7	8	

Series 7								
Length Up To	Overall Finished Width							
	42	63	84	105	126	147	168	
36	261	395	484	617	730	863	953	
48	282	416	526	638	772	905	1,016	
60	303	437	547	680	814	947	1,058	
72	303	458	568	722	856	1,010	1,121	
84	324	479	610	743	898	1,052	1,184	
96	345	500	631	785	940	1,094	1,226	
101	345	500	631	806	961	1,115	1,247	

Series 8								
Length Up To	Overall Finished Width							
	42	63	84	105	126	147	168	
36	276	420	514	657	775	918	1,013	
48	302	446	566	683	827	970	1,091	
60	328	472	592	735	879	1,022	1,143	
72	328	498	618	787	931	1,100	1,221	
84	354	524	670	813	983	1,152	1,299	
96	380	550	696	865	1,035	1,204	1,351	
101	380	550	696	891	1,061	1,230	1,377	

Series 9								
Length Up To	Overall Finished Width							
	42	63	84	105	126	147	168	
36	288	440	538	689	811	962	1,061	
48	318	470	598	719	871	1,022	1,151	
60	348	500	628	779	931	1,082	1,211	
72	348	530	658	839	991	1,172	1,301	
84	378	560	718	869	1,051	1,232	1,391	
96	408	590	748	929	1,111	1,292	1,451	
101	408	590	748	959	1,141	1,322	1,481	

Series 10								
Length Up To	Overall Finished Width							
	42	63	84	105	126	147	168	
36	300	460	562	721	847	1,006	1,109	
48	334	494	630	755	915	1,074	1,211	
60	368	528	664	823	983	1,142	1,279	
72	368	562	698	891	1,051	1,244	1,381	
84	402	596	766	925	1,119	1,312	1,483	
96	436	630	800	993	1,187	1,380	1,551	
101	436	630	800	1,027	1,221	1,414	1,585	

Series 11								
Length Up To	Overall Finished Width							
	42	63	84	105	126	147	168	
36	312	480	586	753	883	1,050	1,157	
48	350	518	662	791	959	1,126	1,271	
60	388	556	700	867	1,035	1,202	1,347	
72	388	594	738	943	1,111	1,316	1,461	
84	426	632	814	981	1,187	1,392	1,575	
96	464	670	852	1,057	1,263	1,468	1,651	
101	464	670	852	1,095	1,301	1,506	1,689	

Series 12								
Length Up To	Overall Finished Width							
	42	63	84	105	126	147	168	
36	324	500	610	785	919	1,094	1,205	
48	366	542	694	827	1,003	1,178	1,331	
60	408	584	736	911	1,087	1,262	1,415	
72	408	626	778	995	1,171	1,388	1,541	
84	450	668	862	1,037	1,255	1,472	1,667	
96	492	710	904	1,121	1,339	1,556	1,751	
101	492	710	904	1,163	1,381	1,598	1,793	

Series 13								
Length Up To	Overall Finished Width							
	42	63	84	105	126	147	168	
36	336	520	634	817	955	1,138	1,253	
48	382	566	726	863	1,047	1,230	1,391	
60	428	612	772	955	1,139	1,322	1,483	
72	428	658	818	1,047	1,231	1,460	1,621	
84	474	704	910	1,093	1,323	1,552	1,759	
96	520	750	956	1,185	1,415	1,644	1,851	
101	520	750	956	1,231	1,461	1,690	1,897	

Series 14								
Length Up To	Overall Finished Width							
	42	63	84	105	126	147	168	
36	348	540	658	849	991	1,182	1,301	
48	398	590	758	899	1,091	1,282	1,451	
60	448	640	808	999	1,191	1,382	1,551	
72	448	690	858	1,099	1,291	1,532	1,701	
84	498	740	958	1,149	1,391	1,632	1,851	
96	548	790	1,008	1,249	1,491	1,732	1,951	
101	548	790	1,008	1,299	1,541	1,782	2,001	

Series 15								
Length Up To	Overall Finished Width							
	42	63	84	105	126	147	168	
36	360	560	682	881	1,027	1,226	1,349	
48	414	614	790	935	1,135	1,334	1,511	
60	468	668	844	1,043	1,243	1,442	1,619	
72	468	722	898	1,151	1,351	1,604	1,781	
84	522	776	1,006	1,205	1,459	1,712	1,943	
96	576	830	1,060	1,313	1,567	1,820	2,051	
101	576	830	1,060	1,367	1,621	1,874	2,105	

Series 16								
Length Up To	Overall Finished Width							
	42	63	84	105	126	147	168	
36	372	580	706	913	1,063	1,270	1,397	
48	430	638	822	971	1,179	1,386	1,571	
60	488	696	880	1,087	1,295	1,502	1,687	
72	488	754	938	1,203	1,411	1,676	1,861	
84	546	812	1,054	1,261	1,527	1,792	2,035	
96	604	870	1,112	1,377	1,643	1,908	2,151	
101	604	870	1,112	1,435	1,701	1,966	2,209	

PLEATED DRAPERIES: 2.5 Fullness — Lined (Lining 01000)

Sizes and series numbers beyond what is listed in the charts below are available—please submit these quote requests via fax or email.

Number of Widths							
2	3	4	5	6	7	8	

Number of Widths							
2	3	4	5	6	7	8	

Series 17

Length Up To	Overall Finished Width						
	42	63	84	105	126	147	168
36	384	600	730	945	1,099	1,314	1,445
48	446	662	854	1,007	1,223	1,438	1,631
60	508	724	916	1,131	1,347	1,562	1,755
72	508	786	978	1,255	1,471	1,748	1,941
84	570	848	1,102	1,317	1,595	1,872	2,127
96	632	910	1,164	1,441	1,719	1,996	2,251
101	632	910	1,164	1,503	1,781	2,058	2,313

Series 18

Length Up To	Overall Finished Width						
	42	63	84	105	126	147	168
36	396	620	754	977	1,135	1,358	1,493
48	462	686	886	1,043	1,267	1,490	1,691
60	528	752	952	1,175	1,399	1,622	1,823
72	528	818	1,018	1,307	1,531	1,820	2,021
84	594	884	1,150	1,373	1,663	1,952	2,219
96	660	950	1,216	1,505	1,795	2,084	2,351
101	660	950	1,216	1,571	1,861	2,150	2,417

Series 19

Length Up To	Overall Finished Width						
	42	63	84	105	126	147	168
36	408	640	778	1,009	1,171	1,402	1,541
48	478	710	918	1,079	1,311	1,542	1,751
60	548	780	988	1,219	1,451	1,682	1,891
72	548	850	1,058	1,359	1,591	1,892	2,101
84	618	920	1,198	1,429	1,731	2,032	2,311
96	688	990	1,268	1,569	1,871	2,172	2,451
101	688	990	1,268	1,639	1,941	2,242	2,521

Series 20

Length Up To	Overall Finished Width						
	42	63	84	105	126	147	168
36	420	660	802	1,041	1,207	1,446	1,589
48	494	734	950	1,115	1,355	1,594	1,811
60	568	808	1,024	1,263	1,503	1,742	1,959
72	568	882	1,098	1,411	1,651	1,964	2,181
84	642	956	1,246	1,485	1,799	2,112	2,403
96	716	1,030	1,320	1,633	1,947	2,260	2,551
101	716	1,030	1,320	1,707	2,021	2,334	2,625

Series 21

Length Up To	Overall Finished Width						
	42	63	84	105	126	147	168
36	432	680	826	1,073	1,243	1,490	1,637
48	510	758	982	1,151	1,399	1,646	1,871
60	588	836	1,060	1,307	1,555	1,802	2,027
72	588	914	1,138	1,463	1,711	2,036	2,261
84	666	992	1,294	1,541	1,867	2,192	2,495
96	744	1,070	1,372	1,697	2,023	2,348	2,651
101	744	1,070	1,372	1,775	2,101	2,426	2,729

Series 22

Length Up To	Overall Finished Width						
	42	63	84	105	126	147	168
36	444	700	850	1,105	1,279	1,534	1,685
48	526	782	1,014	1,187	1,443	1,698	1,931
60	608	864	1,096	1,351	1,607	1,862	2,095
72	608	946	1,178	1,515	1,771	2,108	2,341
84	690	1,028	1,342	1,597	1,935	2,272	2,587
96	772	1,110	1,424	1,761	2,099	2,436	2,751
101	772	1,110	1,424	1,843	2,181	2,518	2,833

Series 23

Length Up To	Overall Finished Width						
	42	63	84	105	126	147	168
36	456	720	874	1,137	1,315	1,578	1,733
48	542	806	1,046	1,223	1,487	1,750	1,991
60	628	892	1,132	1,395	1,659	1,922	2,163
72	628	978	1,218	1,567	1,831	2,180	2,421
84	714	1,064	1,390	1,653	2,003	2,352	2,679
96	800	1,150	1,476	1,825	2,175	2,524	2,851
101	800	1,150	1,476	1,911	2,261	2,610	2,937

Series 24

Length Up To	Overall Finished Width						
	42	63	84	105	126	147	168
36	468	740	898	1,169	1,351	1,622	1,781
48	558	830	1,078	1,259	1,531	1,802	2,051
60	648	920	1,168	1,439	1,711	1,982	2,231
72	648	1,010	1,258	1,619	1,891	2,252	2,501
84	738	1,100	1,438	1,709	2,071	2,432	2,771
96	828	1,190	1,528	1,889	2,251	2,612	2,951
101	828	1,190	1,528	1,979	2,341	2,702	3,041

Series 25

Length Up To	Overall Finished Width						
	42	63	84	105	126	147	168
36	486	770	934	1,217	1,405	1,688	1,853
48	582	866	1,126	1,313	1,597	1,880	2,141
60	678	962	1,222	1,505	1,789	2,072	2,333
72	678	1,058	1,318	1,697	1,981	2,360	2,621
84	774	1,154	1,510	1,793	2,173	2,552	2,909
96	870	1,250	1,606	1,985	2,365	2,744	3,101
101	870	1,250	1,606	2,081	2,461	2,840	3,197

Series 26

Length Up To	Overall Finished Width						
	42	63	84	105	126	147	168
36	498	790	958	1,249	1,441	1,732	1,901
48	598	890	1,158	1,349	1,641	1,932	2,201
60	698	990	1,258	1,549	1,841	2,132	2,401
72	698	1,090	1,358	1,749	2,041	2,432	2,701
84	798	1,190	1,558	1,849	2,241	2,632	3,001
96	898	1,290	1,658	2,049	2,441	2,832	3,201
101	898	1,290	1,658	2,149	2,541	2,932	3,301

PLEATED DRAPERIES: 3 Fullness — Unlined

Sizes and series numbers beyond what is listed in the charts below are available—please submit these quote requests via fax or email.

Number of Widths						
3	4	5	6	8	9	10

Number of Widths						
3	4	5	6	8	9	10

Series 7							
Length Up To	Overall Finished Width						
	42	63	84	105	126	147	168
36	177	233	293	350	449	505	565
48	198	275	314	392	512	568	628
72	240	317	398	476	617	694	775
84	261	359	419	518	680	757	838
108	303	401	503	602	785	883	985
120	324	443	524	644	848	946	1,048
144	366	485	608	728	953	1,072	1,195

Series 8							
Length Up To	Overall Finished Width						
	42	63	84	105	126	147	168
36	202	263	333	395	509	570	640
48	228	315	359	447	587	648	718
72	280	367	463	551	717	804	900
84	306	419	489	603	795	882	978
108	358	471	593	707	925	1,038	1,160
120	384	523	619	759	1,003	1,116	1,238
144	436	575	723	863	1,133	1,272	1,420

Series 9							
Length Up To	Overall Finished Width						
	42	63	84	105	126	147	168
36	222	287	365	431	557	622	700
48	252	347	395	491	647	712	790
72	312	407	515	611	797	892	1,000
84	342	467	545	671	887	982	1,090
108	402	527	665	791	1,037	1,162	1,300
120	432	587	695	851	1,127	1,252	1,390
144	492	647	815	971	1,277	1,432	1,600

Series 10							
Length Up To	Overall Finished Width						
	42	63	84	105	126	147	168
36	242	311	397	467	605	674	760
48	276	379	431	535	707	776	862
72	344	447	567	671	877	980	1,100
84	378	515	601	739	979	1,082	1,202
108	446	583	737	875	1,149	1,286	1,440
120	480	651	771	943	1,251	1,388	1,542
144	548	719	907	1,079	1,421	1,592	1,780

Series 11							
Length Up To	Overall Finished Width						
	42	63	84	105	126	147	168
36	262	335	429	503	653	726	820
48	300	411	467	579	767	840	934
72	376	487	619	731	957	1,068	1,200
84	414	563	657	807	1,071	1,182	1,314
108	490	639	809	959	1,261	1,410	1,580
120	528	715	847	1,035	1,375	1,524	1,694
144	604	791	999	1,187	1,565	1,752	1,960

Series 12							
Length Up To	Overall Finished Width						
	42	63	84	105	126	147	168
36	282	359	461	539	701	778	880
48	324	443	503	623	827	904	1,006
72	408	527	671	791	1,037	1,156	1,300
84	450	611	713	875	1,163	1,282	1,426
108	534	695	881	1,043	1,373	1,534	1,720
120	576	779	923	1,127	1,499	1,660	1,846
144	660	863	1,091	1,295	1,709	1,912	2,140

Series 13							
Length Up To	Overall Finished Width						
	42	63	84	105	126	147	168
36	302	383	493	575	749	830	940
48	348	475	539	667	887	968	1,078
72	440	567	723	851	1,117	1,244	1,400
84	486	659	769	943	1,255	1,382	1,538
108	578	751	953	1,127	1,485	1,658	1,860
120	624	843	999	1,219	1,623	1,796	1,998
144	716	935	1,183	1,403	1,853	2,072	2,320

Series 14							
Length Up To	Overall Finished Width						
	42	63	84	105	126	147	168
36	322	407	525	611	797	882	1,000
48	372	507	575	711	947	1,032	1,150
72	472	607	775	911	1,197	1,332	1,500
84	522	707	825	1,011	1,347	1,482	1,650
108	622	807	1,025	1,211	1,597	1,782	2,000
120	672	907	1,075	1,311	1,747	1,932	2,150
144	772	1,007	1,275	1,511	1,997	2,232	2,500

Series 15							
Length Up To	Overall Finished Width						
	42	63	84	105	126	147	168
36	342	431	557	647	845	934	1,060
48	396	539	611	755	1,007	1,096	1,222
72	504	647	827	971	1,277	1,420	1,600
84	558	755	881	1,079	1,439	1,582	1,762
108	666	863	1,097	1,295	1,709	1,906	2,140
120	720	971	1,151	1,403	1,871	2,068	2,302
144	828	1,079	1,367	1,619	2,141	2,392	2,680

Series 16							
Length Up To	Overall Finished Width						
	42	63	84	105	126	147	168
36	362	455	589	683	893	986	1,120
48	420	571	647	799	1,067	1,160	1,294
72	536	687	879	1,031	1,357	1,508	1,700
84	594	803	937	1,147	1,531	1,682	1,874
108	710	919	1,169	1,379	1,821	2,030	2,280
120	768	1,035	1,227	1,495	1,995	2,204	2,454
144	884	1,151	1,459	1,727	2,285	2,552	2,860

PLEATED DRAPERIES: 3 Fullness — Unlined

Sizes and series numbers beyond what is listed in the charts below are available—please submit these quote requests via fax or email.

Number of Widths						
3	4	5	6	8	9	10

Number of Widths						
3	4	5	6	8	9	10

Series 17

Length Up To	Overall Finished Width						
	42	63	84	105	126	147	168
36	382	479	621	719	941	1,038	1,180
48	444	603	683	843	1,127	1,224	1,366
72	568	727	931	1,091	1,437	1,596	1,800
84	630	851	993	1,215	1,623	1,782	1,986
108	754	975	1,241	1,463	1,933	2,154	2,420
120	816	1,099	1,303	1,587	2,119	2,340	2,606
144	940	1,223	1,551	1,835	2,429	2,712	3,040

Series 18

Length Up To	Overall Finished Width						
	42	63	84	105	126	147	168
36	402	503	653	755	989	1,090	1,240
48	468	635	719	887	1,187	1,288	1,438
72	600	767	983	1,151	1,517	1,684	1,900
84	666	899	1,049	1,283	1,715	1,882	2,098
108	798	1,031	1,313	1,547	2,045	2,278	2,560
120	864	1,163	1,379	1,679	2,243	2,476	2,758
144	996	1,295	1,643	1,943	2,573	2,872	3,220

Series 19

Length Up To	Overall Finished Width						
	42	63	84	105	126	147	168
36	422	527	685	791	1,037	1,142	1,300
48	492	667	755	931	1,247	1,352	1,510
72	632	807	1,035	1,211	1,597	1,772	2,000
84	702	947	1,105	1,351	1,807	1,982	2,210
108	842	1,087	1,385	1,631	2,157	2,402	2,700
120	912	1,227	1,455	1,771	2,367	2,612	2,910
144	1,052	1,367	1,735	2,051	2,717	3,032	3,400

Series 20

Length Up To	Overall Finished Width						
	42	63	84	105	126	147	168
36	442	551	717	827	1,085	1,194	1,360
48	516	699	791	975	1,307	1,416	1,582
72	664	847	1,087	1,271	1,677	1,860	2,100
84	738	995	1,161	1,419	1,899	2,082	2,322
108	886	1,143	1,457	1,715	2,269	2,526	2,840
120	960	1,291	1,531	1,863	2,491	2,748	3,062
144	1,108	1,439	1,827	2,159	2,861	3,192	3,580

Series 21

Length Up To	Overall Finished Width						
	42	63	84	105	126	147	168
36	462	575	749	863	1,133	1,246	1,420
48	540	731	827	1,019	1,367	1,480	1,654
72	696	887	1,139	1,331	1,757	1,948	2,200
84	774	1,043	1,217	1,487	1,991	2,182	2,434
108	930	1,199	1,529	1,799	2,381	2,650	2,980
120	1,008	1,355	1,607	1,955	2,615	2,884	3,214
144	1,164	1,511	1,919	2,267	3,005	3,352	3,760

Series 22

Length Up To	Overall Finished Width						
	42	63	84	105	126	147	168
36	482	599	781	899	1,181	1,298	1,480
48	564	763	863	1,063	1,427	1,544	1,726
72	728	927	1,191	1,391	1,837	2,036	2,300
84	810	1,091	1,273	1,555	2,083	2,282	2,546
108	974	1,255	1,601	1,883	2,493	2,774	3,120
120	1,056	1,419	1,683	2,047	2,739	3,020	3,366
144	1,220	1,583	2,011	2,375	3,149	3,512	3,940

Series 23

Length Up To	Overall Finished Width						
	42	63	84	105	126	147	168
36	502	623	813	935	1,229	1,350	1,540
48	588	795	899	1,107	1,487	1,608	1,798
72	760	967	1,243	1,451	1,917	2,124	2,400
84	846	1,139	1,329	1,623	2,175	2,382	2,658
108	1,018	1,311	1,673	1,967	2,605	2,898	3,260
120	1,104	1,483	1,759	2,139	2,863	3,156	3,518
144	1,276	1,655	2,103	2,483	3,293	3,672	4,120

Series 24

Length Up To	Overall Finished Width						
	42	63	84	105	126	147	168
36	522	647	845	971	1,277	1,402	1,600
48	612	827	935	1,151	1,547	1,672	1,870
72	792	1,007	1,295	1,511	1,997	2,212	2,500
84	882	1,187	1,385	1,691	2,267	2,482	2,770
108	1,062	1,367	1,745	2,051	2,717	3,022	3,400
120	1,152	1,547	1,835	2,231	2,987	3,292	3,670
144	1,332	1,727	2,195	2,591	3,437	3,832	4,300

Series 25

Length Up To	Overall Finished Width						
	42	63	84	105	126	147	168
36	552	683	893	1,025	1,349	1,480	1,690
48	648	875	989	1,217	1,637	1,768	1,978
72	840	1,067	1,373	1,601	2,117	2,344	2,650
84	936	1,259	1,469	1,793	2,405	2,632	2,938
108	1,128	1,451	1,853	2,177	2,885	3,208	3,610
120	1,224	1,643	1,949	2,369	3,173	3,496	3,898
144	1,416	1,835	2,333	2,753	3,653	4,072	4,570

Series 26

Length Up To	Overall Finished Width						
	42	63	84	105	126	147	168
36	572	707	925	1,061	1,397	1,532	1,750
48	672	907	1,025	1,261	1,697	1,832	2,050
72	872	1,107	1,425	1,661	2,197	2,432	2,750
84	972	1,307	1,525	1,861	2,497	2,732	3,050
108	1,172	1,507	1,925	2,261	2,997	3,332	3,750
120	1,272	1,707	2,025	2,461	3,297	3,632	4,050
144	1,472	1,907	2,425	2,861	3,797	4,232	4,750

PLEATED DRAPERIES: 3 Fullness — Lined (Lining 01000)

Sizes and series numbers beyond what is listed in the charts below are available—please submit these quote requests via fax or email.

Number of Widths						
3	4	5	6	8	9	10

Number of Widths						
3	4	5	6	8	9	10

Series 7

Length Up To	Overall Finished Width						
	42	63	84	105	126	147	168
36	318	446	556	683	838	965	1,076
48	339	488	577	725	901	1,028	1,139
60	360	509	619	767	943	1,091	1,223
72	381	530	661	809	1,006	1,154	1,286
84	402	572	682	851	1,069	1,217	1,349
96	423	593	724	893	1,111	1,280	1,433
101	423	593	745	914	1,132	1,322	1,454

Series 8

Length Up To	Overall Finished Width						
	42	63	84	105	126	147	168
36	343	476	596	728	898	1,030	1,151
48	369	528	622	780	976	1,108	1,229
60	395	554	674	832	1,028	1,186	1,333
72	421	580	726	884	1,106	1,264	1,411
84	447	632	752	936	1,184	1,342	1,489
96	473	658	804	988	1,236	1,420	1,593
101	473	658	830	1,014	1,262	1,472	1,619

Series 9

Length Up To	Overall Finished Width						
	42	63	84	105	126	147	168
36	363	500	628	764	946	1,082	1,211
48	393	560	658	824	1,036	1,172	1,301
60	423	590	718	884	1,096	1,262	1,421
72	453	620	778	944	1,186	1,352	1,511
84	483	680	808	1,004	1,276	1,442	1,601
96	513	710	868	1,064	1,336	1,532	1,721
101	513	710	898	1,094	1,366	1,592	1,751

Series 10

Length Up To	Overall Finished Width						
	42	63	84	105	126	147	168
36	383	524	660	800	994	1,134	1,271
48	417	592	694	868	1,096	1,236	1,373
60	451	626	762	936	1,164	1,338	1,509
72	485	660	830	1,004	1,266	1,440	1,611
84	519	728	864	1,072	1,368	1,542	1,713
96	553	762	932	1,140	1,436	1,644	1,849
101	553	762	966	1,174	1,470	1,712	1,883

Series 11

Length Up To	Overall Finished Width						
	42	63	84	105	126	147	168
36	403	548	692	836	1,042	1,186	1,331
48	441	624	730	912	1,156	1,300	1,445
60	479	662	806	988	1,232	1,414	1,597
72	517	700	882	1,064	1,346	1,528	1,711
84	555	776	920	1,140	1,460	1,642	1,825
96	593	814	996	1,216	1,536	1,756	1,977
101	593	814	1,034	1,254	1,574	1,832	2,015

Series 12

Length Up To	Overall Finished Width						
	42	63	84	105	126	147	168
36	423	572	724	872	1,090	1,238	1,391
48	465	656	766	956	1,216	1,364	1,517
60	507	698	850	1,040	1,300	1,490	1,685
72	549	740	934	1,124	1,426	1,616	1,811
84	591	824	976	1,208	1,552	1,742	1,937
96	633	866	1,060	1,292	1,636	1,868	2,105
101	633	866	1,102	1,334	1,678	1,952	2,147

Series 13

Length Up To	Overall Finished Width						
	42	63	84	105	126	147	168
36	443	596	756	908	1,138	1,290	1,451
48	489	688	802	1,000	1,276	1,428	1,589
60	535	734	894	1,092	1,368	1,566	1,773
72	581	780	986	1,184	1,506	1,704	1,911
84	627	872	1,032	1,276	1,644	1,842	2,049
96	673	918	1,124	1,368	1,736	1,980	2,233
101	673	918	1,170	1,414	1,782	2,072	2,279

Series 14

Length Up To	Overall Finished Width						
	42	63	84	105	126	147	168
36	463	620	788	944	1,186	1,342	1,511
48	513	720	838	1,044	1,336	1,492	1,661
60	563	770	938	1,144	1,436	1,642	1,861
72	613	820	1,038	1,244	1,586	1,792	2,011
84	663	920	1,088	1,344	1,736	1,942	2,161
96	713	970	1,188	1,444	1,836	2,092	2,361
101	713	970	1,238	1,494	1,886	2,192	2,411

Series 15

Length Up To	Overall Finished Width						
	42	63	84	105	126	147	168
36	483	644	820	980	1,234	1,394	1,571
48	537	752	874	1,088	1,396	1,556	1,733
60	591	806	982	1,196	1,504	1,718	1,949
72	645	860	1,090	1,304	1,666	1,880	2,111
84	699	968	1,144	1,412	1,828	2,042	2,273
96	753	1,022	1,252	1,520	1,936	2,204	2,489
101	753	1,022	1,306	1,574	1,990	2,312	2,543

Series 16

Length Up To	Overall Finished Width						
	42	63	84	105	126	147	168
36	503	668	852	1,016	1,282	1,446	1,631
48	561	784	910	1,132	1,456	1,620	1,805
60	619	842	1,026	1,248	1,572	1,794	2,037
72	677	900	1,142	1,364	1,746	1,968	2,211
84	735	1,016	1,200	1,480	1,920	2,142	2,385
96	793	1,074	1,316	1,596	2,036	2,316	2,617
101	793	1,074	1,374	1,654	2,094	2,432	2,675

PLEATED DRAPERIES: 3 Fullness — Lined (Lining 01000)

Sizes and series numbers beyond what is listed in the charts below are available—please submit these quote requests via fax or email.

Number of Widths						
3	4	5	6	8	9	10

Number of Widths						
3	4	5	6	8	9	10

Series 17

Length Up To	Overall Finished Width						
	42	63	84	105	126	147	168
36	523	692	884	1,052	1,330	1,498	1,691
48	585	816	946	1,176	1,516	1,684	1,877
60	647	878	1,070	1,300	1,640	1,870	2,125
72	709	940	1,194	1,424	1,826	2,056	2,311
84	771	1,064	1,256	1,548	2,012	2,242	2,497
96	833	1,126	1,380	1,672	2,136	2,428	2,745
101	833	1,126	1,442	1,734	2,198	2,552	2,807

Series 18

Length Up To	Overall Finished Width						
	42	63	84	105	126	147	168
36	543	716	916	1,088	1,378	1,550	1,751
48	609	848	982	1,220	1,576	1,748	1,949
60	675	914	1,114	1,352	1,708	1,946	2,213
72	741	980	1,246	1,484	1,906	2,144	2,411
84	807	1,112	1,312	1,616	2,104	2,342	2,609
96	873	1,178	1,444	1,748	2,236	2,540	2,873
101	873	1,178	1,510	1,814	2,302	2,672	2,939

Series 19

Length Up To	Overall Finished Width						
	42	63	84	105	126	147	168
36	563	740	948	1,124	1,426	1,602	1,811
48	633	880	1,018	1,264	1,636	1,812	2,021
60	703	950	1,158	1,404	1,776	2,022	2,301
72	773	1,020	1,298	1,544	1,986	2,232	2,511
84	843	1,160	1,368	1,684	2,196	2,442	2,721
96	913	1,230	1,508	1,824	2,336	2,652	3,001
101	913	1,230	1,578	1,894	2,406	2,792	3,071

Series 20

Length Up To	Overall Finished Width						
	42	63	84	105	126	147	168
36	583	764	980	1,160	1,474	1,654	1,871
48	657	912	1,054	1,308	1,696	1,876	2,093
60	731	986	1,202	1,456	1,844	2,098	2,389
72	805	1,060	1,350	1,604	2,066	2,320	2,611
84	879	1,208	1,424	1,752	2,288	2,542	2,833
96	953	1,282	1,572	1,900	2,436	2,764	3,129
101	953	1,282	1,646	1,974	2,510	2,912	3,203

Series 21

Length Up To	Overall Finished Width						
	42	63	84	105	126	147	168
36	603	788	1,012	1,196	1,522	1,706	1,931
48	681	944	1,090	1,352	1,756	1,940	2,165
60	759	1,022	1,246	1,508	1,912	2,174	2,477
72	837	1,100	1,402	1,664	2,146	2,408	2,711
84	915	1,256	1,480	1,820	2,380	2,642	2,945
96	993	1,334	1,636	1,976	2,536	2,876	3,257
101	993	1,334	1,714	2,054	2,614	3,032	3,335

Series 22

Length Up To	Overall Finished Width						
	42	63	84	105	126	147	168
36	623	812	1,044	1,232	1,570	1,758	1,991
48	705	976	1,126	1,396	1,816	2,004	2,237
60	787	1,058	1,290	1,560	1,980	2,250	2,565
72	869	1,140	1,454	1,724	2,226	2,496	2,811
84	951	1,304	1,536	1,888	2,472	2,742	3,057
96	1,033	1,386	1,700	2,052	2,636	2,988	3,385
101	1,033	1,386	1,782	2,134	2,718	3,152	3,467

Series 23

Length Up To	Overall Finished Width						
	42	63	84	105	126	147	168
36	643	836	1,076	1,268	1,618	1,810	2,051
48	729	1,008	1,162	1,440	1,876	2,068	2,309
60	815	1,094	1,334	1,612	2,048	2,326	2,653
72	901	1,180	1,506	1,784	2,306	2,584	2,911
84	987	1,352	1,592	1,956	2,564	2,842	3,169
96	1,073	1,438	1,764	2,128	2,736	3,100	3,513
101	1,073	1,438	1,850	2,214	2,822	3,272	3,599

Series 24

Length Up To	Overall Finished Width						
	42	63	84	105	126	147	168
36	663	860	1,108	1,304	1,666	1,862	2,111
48	753	1,040	1,198	1,484	1,936	2,132	2,381
60	843	1,130	1,378	1,664	2,116	2,402	2,741
72	933	1,220	1,558	1,844	2,386	2,672	3,011
84	1,023	1,400	1,648	2,024	2,656	2,942	3,281
96	1,113	1,490	1,828	2,204	2,836	3,212	3,641
101	1,113	1,490	1,918	2,294	2,926	3,392	3,731

Series 25

Length Up To	Overall Finished Width						
	42	63	84	105	126	147	168
36	693	896	1,156	1,358	1,738	1,940	2,201
48	789	1,088	1,252	1,550	2,026	2,228	2,489
60	885	1,184	1,444	1,742	2,218	2,516	2,873
72	981	1,280	1,636	1,934	2,506	2,804	3,161
84	1,077	1,472	1,732	2,126	2,794	3,092	3,449
96	1,173	1,568	1,924	2,318	2,986	3,380	3,833
101	1,173	1,568	2,020	2,414	3,082	3,572	3,929

Series 26

Length Up To	Overall Finished Width						
	42	63	84	105	126	147	168
36	713	920	1,188	1,394	1,786	1,992	2,261
48	813	1,120	1,288	1,594	2,086	2,292	2,561
60	913	1,220	1,488	1,794	2,286	2,592	2,961
72	1,013	1,320	1,688	1,994	2,586	2,892	3,261
84	1,113	1,520	1,788	2,194	2,886	3,192	3,561
96	1,213	1,620	1,988	2,394	3,086	3,492	3,961
101	1,213	1,620	2,088	2,494	3,186	3,692	4,061

PLEATED DRAPERIES: 4 Fullness — Unlined

Sizes and series numbers beyond what is listed in the charts below are available—please submit these quote requests via fax or email.

Number of Widths						
4	5	7	8	10	12	13

Number of Widths						
4	5	7	8	10	12	13

Series 7							
Length Up To	Overall Finished Width						
	42	63	84	105	126	147	168
36	198	275	356	413	512	610	649
48	240	296	398	476	575	694	754
72	282	380	503	581	722	862	922
84	324	401	545	644	785	946	1,027
108	366	485	650	749	932	1,114	1,195
120	408	506	692	812	995	1,198	1,300
144	450	590	797	917	1,142	1,366	1,468

Series 8							
Length Up To	Overall Finished Width						
	42	63	84	105	126	147	168
36	228	315	411	473	587	700	744
48	280	341	463	551	665	804	874
72	332	445	593	681	847	1,012	1,082
84	384	471	645	759	925	1,116	1,212
108	436	575	775	889	1,107	1,324	1,420
120	488	601	827	967	1,185	1,428	1,550
144	540	705	957	1,097	1,367	1,636	1,758

Series 9							
Length Up To	Overall Finished Width						
	42	63	84	105	126	147	168
36	252	347	455	521	647	772	820
48	312	377	515	611	737	892	970
72	372	497	665	761	947	1,132	1,210
84	432	527	725	851	1,037	1,252	1,360
108	492	647	875	1,001	1,247	1,492	1,600
120	552	677	935	1,091	1,337	1,612	1,750
144	612	797	1,085	1,241	1,547	1,852	1,990

Series 10							
Length Up To	Overall Finished Width						
	42	63	84	105	126	147	168
36	276	379	499	569	707	844	896
48	344	413	567	671	809	980	1,066
72	412	549	737	841	1,047	1,252	1,338
84	480	583	805	943	1,149	1,388	1,508
108	548	719	975	1,113	1,387	1,660	1,780
120	616	753	1,043	1,215	1,489	1,796	1,950
144	684	889	1,213	1,385	1,727	2,068	2,222

Series 11							
Length Up To	Overall Finished Width						
	42	63	84	105	126	147	168
36	300	411	543	617	767	916	972
48	376	449	619	731	881	1,068	1,162
72	452	601	809	921	1,147	1,372	1,466
84	528	639	885	1,035	1,261	1,524	1,656
108	604	791	1,075	1,225	1,527	1,828	1,960
120	680	829	1,151	1,339	1,641	1,980	2,150
144	756	981	1,341	1,529	1,907	2,284	2,454

Series 12							
Length Up To	Overall Finished Width						
	42	63	84	105	126	147	168
36	324	443	587	665	827	988	1,048
48	408	485	671	791	953	1,156	1,258
72	492	653	881	1,001	1,247	1,492	1,594
84	576	695	965	1,127	1,373	1,660	1,804
108	660	863	1,175	1,337	1,667	1,996	2,140
120	744	905	1,259	1,463	1,793	2,164	2,350
144	828	1,073	1,469	1,673	2,087	2,500	2,686

Series 13							
Length Up To	Overall Finished Width						
	42	63	84	105	126	147	168
36	348	475	631	713	887	1,060	1,124
48	440	521	723	851	1,025	1,244	1,354
72	532	705	953	1,081	1,347	1,612	1,722
84	624	751	1,045	1,219	1,485	1,796	1,952
108	716	935	1,275	1,449	1,807	2,164	2,320
120	808	981	1,367	1,587	1,945	2,348	2,550
144	900	1,165	1,597	1,817	2,267	2,716	2,918

Series 14							
Length Up To	Overall Finished Width						
	42	63	84	105	126	147	168
36	372	507	675	761	947	1,132	1,200
48	472	557	775	911	1,097	1,332	1,450
72	572	757	1,025	1,161	1,447	1,732	1,850
84	672	807	1,125	1,311	1,597	1,932	2,100
108	772	1,007	1,375	1,561	1,947	2,332	2,500
120	872	1,057	1,475	1,711	2,097	2,532	2,750
144	972	1,257	1,725	1,961	2,447	2,932	3,150

Series 15							
Length Up To	Overall Finished Width						
	42	63	84	105	126	147	168
36	396	539	719	809	1,007	1,204	1,276
48	504	593	827	971	1,169	1,420	1,546
72	612	809	1,097	1,241	1,547	1,852	1,978
84	720	863	1,205	1,403	1,709	2,068	2,248
108	828	1,079	1,475	1,673	2,087	2,500	2,680
120	936	1,133	1,583	1,835	2,249	2,716	2,950
144	1,044	1,349	1,853	2,105	2,627	3,148	3,382

Series 16							
Length Up To	Overall Finished Width						
	42	63	84	105	126	147	168
36	420	571	763	857	1,067	1,276	1,352
48	536	629	879	1,031	1,241	1,508	1,642
72	652	861	1,169	1,321	1,647	1,972	2,106
84	768	919	1,285	1,495	1,821	2,204	2,396
108	884	1,151	1,575	1,785	2,227	2,668	2,860
120	1,000	1,209	1,691	1,959	2,401	2,900	3,150
144	1,116	1,441	1,981	2,249	2,807	3,364	3,614

PLEATED DRAPERIES: 4 Fullness — Unlined

Sizes and series numbers beyond what is listed in the charts below are available—please submit these quote requests via fax or email.

Number of Widths						
4	5	7	8	10	12	13

Number of Widths						
4	5	7	8	10	12	13

Series 17

Length Up To	Overall Finished Width						
	42	63	84	105	126	147	168
36	444	603	807	905	1,127	1,348	1,428
48	568	665	931	1,091	1,313	1,596	1,738
72	692	913	1,241	1,401	1,747	2,092	2,234
84	816	975	1,365	1,587	1,933	2,340	2,544
108	940	1,223	1,675	1,897	2,367	2,836	3,040
120	1,064	1,285	1,799	2,083	2,553	3,084	3,350
144	1,188	1,533	2,109	2,393	2,987	3,580	3,846

Series 18

Length Up To	Overall Finished Width						
	42	63	84	105	126	147	168
36	468	635	851	953	1,187	1,420	1,504
48	600	701	983	1,151	1,385	1,684	1,834
72	732	965	1,313	1,481	1,847	2,212	2,362
84	864	1,031	1,445	1,679	2,045	2,476	2,692
108	996	1,295	1,775	2,009	2,507	3,004	3,220
120	1,128	1,361	1,907	2,207	2,705	3,268	3,550
144	1,260	1,625	2,237	2,537	3,167	3,796	4,078

Series 19

Length Up To	Overall Finished Width						
	42	63	84	105	126	147	168
36	492	667	895	1,001	1,247	1,492	1,580
48	632	737	1,035	1,211	1,457	1,772	1,930
72	772	1,017	1,385	1,561	1,947	2,332	2,490
84	912	1,087	1,525	1,771	2,157	2,612	2,840
108	1,052	1,367	1,875	2,121	2,647	3,172	3,400
120	1,192	1,437	2,015	2,331	2,857	3,452	3,750
144	1,332	1,717	2,365	2,681	3,347	4,012	4,310

Series 20

Length Up To	Overall Finished Width						
	42	63	84	105	126	147	168
36	516	699	939	1,049	1,307	1,564	1,656
48	664	773	1,087	1,271	1,529	1,860	2,026
72	812	1,069	1,457	1,641	2,047	2,452	2,618
84	960	1,143	1,605	1,863	2,269	2,748	2,988
108	1,108	1,439	1,975	2,233	2,787	3,340	3,580
120	1,256	1,513	2,123	2,455	3,009	3,636	3,950
144	1,404	1,809	2,493	2,825	3,527	4,228	4,542

Series 21

Length Up To	Overall Finished Width						
	42	63	84	105	126	147	168
36	540	731	983	1,097	1,367	1,636	1,732
48	696	809	1,139	1,331	1,601	1,948	2,122
72	852	1,121	1,529	1,721	2,147	2,572	2,746
84	1,008	1,199	1,685	1,955	2,381	2,884	3,136
108	1,164	1,511	2,075	2,345	2,927	3,508	3,760
120	1,320	1,589	2,231	2,579	3,161	3,820	4,150
144	1,476	1,901	2,621	2,969	3,707	4,444	4,774

Series 22

Length Up To	Overall Finished Width						
	42	63	84	105	126	147	168
36	564	763	1,027	1,145	1,427	1,708	1,808
48	728	845	1,191	1,391	1,673	2,036	2,218
72	892	1,173	1,601	1,801	2,247	2,692	2,874
84	1,056	1,255	1,765	2,047	2,493	3,020	3,284
108	1,220	1,583	2,175	2,457	3,067	3,676	3,940
120	1,384	1,665	2,339	2,703	3,313	4,004	4,350
144	1,548	1,993	2,749	3,113	3,887	4,660	5,006

Series 23

Length Up To	Overall Finished Width						
	42	63	84	105	126	147	168
36	588	795	1,071	1,193	1,487	1,780	1,884
48	760	881	1,243	1,451	1,745	2,124	2,314
72	932	1,225	1,673	1,881	2,347	2,812	3,002
84	1,104	1,311	1,845	2,139	2,605	3,156	3,432
108	1,276	1,655	2,275	2,569	3,207	3,844	4,120
120	1,448	1,741	2,447	2,827	3,465	4,188	4,550
144	1,620	2,085	2,877	3,257	4,067	4,876	5,238

Series 24

Length Up To	Overall Finished Width						
	42	63	84	105	126	147	168
36	612	827	1,115	1,241	1,547	1,852	1,960
48	792	917	1,295	1,511	1,817	2,212	2,410
72	972	1,277	1,745	1,961	2,447	2,932	3,130
84	1,152	1,367	1,925	2,231	2,717	3,292	3,580
108	1,332	1,727	2,375	2,681	3,347	4,012	4,300
120	1,512	1,817	2,555	2,951	3,617	4,372	4,750
144	1,692	2,177	3,005	3,401	4,247	5,092	5,470

Series 25

Length Up To	Overall Finished Width						
	42	63	84	105	126	147	168
36	648	875	1,181	1,313	1,637	1,960	2,074
48	840	971	1,373	1,601	1,925	2,344	2,554
72	1,032	1,355	1,853	2,081	2,597	3,112	3,322
84	1,224	1,451	2,045	2,369	2,885	3,496	3,802
108	1,416	1,835	2,525	2,849	3,557	4,264	4,570
120	1,608	1,931	2,717	3,137	3,845	4,648	5,050
144	1,800	2,315	3,197	3,617	4,517	5,416	5,818

Series 26

Length Up To	Overall Finished Width						
	42	63	84	105	126	147	168
36	672	907	1,225	1,361	1,697	2,032	2,150
48	872	1,007	1,425	1,661	1,997	2,432	2,650
72	1,072	1,407	1,925	2,161	2,697	3,232	3,450
84	1,272	1,507	2,125	2,461	2,997	3,632	3,950
108	1,472	1,907	2,625	2,961	3,697	4,432	4,750
120	1,672	2,007	2,825	3,261	3,997	4,832	5,250
144	1,872	2,407	3,325	3,761	4,697	5,632	6,050

PLEATED DRAPERIES: 4 Fullness — Lined (Lining 01000)

Sizes and series numbers beyond what is listed in the charts below are available—please submit these quote requests via fax or email.

Number of Widths						
4	5	7	8	10	12	13

Number of Widths						
4	5	7	8	10	12	13

Series 7

Length Up To	Overall Finished Width						
	42	63	84	105	126	147	168
36	384	533	694	836	1,006	1,190	1,310
48	426	554	736	899	1,069	1,274	1,415
60	447	596	778	941	1,153	1,358	1,499
72	468	638	841	1,004	1,216	1,442	1,583
84	510	659	883	1,067	1,279	1,526	1,688
96	531	701	925	1,109	1,363	1,610	1,772
101	531	722	946	1,130	1,384	1,631	1,814

Series 8

Length Up To	Overall Finished Width						
	42	63	84	105	126	147	168
36	414	573	749	896	1,081	1,280	1,405
48	466	599	801	974	1,159	1,384	1,535
60	492	651	853	1,026	1,263	1,488	1,639
72	518	703	931	1,104	1,341	1,592	1,743
84	570	729	983	1,182	1,419	1,696	1,873
96	596	781	1,035	1,234	1,523	1,800	1,977
101	596	807	1,061	1,260	1,549	1,826	2,029

Series 9

Length Up To	Overall Finished Width						
	42	63	84	105	126	147	168
36	438	605	793	944	1,141	1,352	1,481
48	498	635	853	1,034	1,231	1,472	1,631
60	528	695	913	1,094	1,351	1,592	1,751
72	558	755	1,003	1,184	1,441	1,712	1,871
84	618	785	1,063	1,274	1,531	1,832	2,021
96	648	845	1,123	1,334	1,651	1,952	2,141
101	648	875	1,153	1,364	1,681	1,982	2,201

Series 10

Length Up To	Overall Finished Width						
	42	63	84	105	126	147	168
36	462	637	837	992	1,201	1,424	1,557
48	530	671	905	1,094	1,303	1,560	1,727
60	564	739	973	1,162	1,439	1,696	1,863
72	598	807	1,075	1,264	1,541	1,832	1,999
84	666	841	1,143	1,366	1,643	1,968	2,169
96	700	909	1,211	1,434	1,779	2,104	2,305
101	700	943	1,245	1,468	1,813	2,138	2,373

Series 11

Length Up To	Overall Finished Width						
	42	63	84	105	126	147	168
36	486	669	881	1,040	1,261	1,496	1,633
48	562	707	957	1,154	1,375	1,648	1,823
60	600	783	1,033	1,230	1,527	1,800	1,975
72	638	859	1,147	1,344	1,641	1,952	2,127
84	714	897	1,223	1,458	1,755	2,104	2,317
96	752	973	1,299	1,534	1,907	2,256	2,469
101	752	1,011	1,337	1,572	1,945	2,294	2,545

Series 12

Length Up To	Overall Finished Width						
	42	63	84	105	126	147	168
36	510	701	925	1,088	1,321	1,568	1,709
48	594	743	1,009	1,214	1,447	1,736	1,919
60	636	827	1,093	1,298	1,615	1,904	2,087
72	678	911	1,219	1,424	1,741	2,072	2,255
84	762	953	1,303	1,550	1,867	2,240	2,465
96	804	1,037	1,387	1,634	2,035	2,408	2,633
101	804	1,079	1,429	1,676	2,077	2,450	2,717

Series 13

Length Up To	Overall Finished Width						
	42	63	84	105	126	147	168
36	534	733	969	1,136	1,381	1,640	1,785
48	626	779	1,061	1,274	1,519	1,824	2,015
60	672	871	1,153	1,366	1,703	2,008	2,199
72	718	963	1,291	1,504	1,841	2,192	2,383
84	810	1,009	1,383	1,642	1,979	2,376	2,613
96	856	1,101	1,475	1,734	2,163	2,560	2,797
101	856	1,147	1,521	1,780	2,209	2,606	2,889

Series 14

Length Up To	Overall Finished Width						
	42	63	84	105	126	147	168
36	558	765	1,013	1,184	1,441	1,712	1,861
48	658	815	1,113	1,334	1,591	1,912	2,111
60	708	915	1,213	1,434	1,791	2,112	2,311
72	758	1,015	1,363	1,584	1,941	2,312	2,511
84	858	1,065	1,463	1,734	2,091	2,512	2,761
96	908	1,165	1,563	1,834	2,291	2,712	2,961
101	908	1,215	1,613	1,884	2,341	2,762	3,061

Series 15

Length Up To	Overall Finished Width						
	42	63	84	105	126	147	168
36	582	797	1,057	1,232	1,501	1,784	1,937
48	690	851	1,165	1,394	1,663	2,000	2,207
60	744	959	1,273	1,502	1,879	2,216	2,423
72	798	1,067	1,435	1,664	2,041	2,432	2,639
84	906	1,121	1,543	1,826	2,203	2,648	2,909
96	960	1,229	1,651	1,934	2,419	2,864	3,125
101	960	1,283	1,705	1,988	2,473	2,918	3,233

Series 16

Length Up To	Overall Finished Width						
	42	63	84	105	126	147	168
36	606	829	1,101	1,280	1,561	1,856	2,013
48	722	887	1,217	1,454	1,735	2,088	2,303
60	780	1,003	1,333	1,570	1,967	2,320	2,535
72	838	1,119	1,507	1,744	2,141	2,552	2,767
84	954	1,177	1,623	1,918	2,315	2,784	3,057
96	1,012	1,293	1,739	2,034	2,547	3,016	3,289
101	1,012	1,351	1,797	2,092	2,605	3,074	3,405

PLEATED DRAPERIES: 4 Fullness — Lined (Lining 01000)

Sizes and series numbers beyond what is listed in the charts below are available—please submit these quote requests via fax or email.

Number of Widths						
4	5	7	8	10	12	13

Number of Widths						
4	5	7	8	10	12	13

Series 17

Length Up To	Overall Finished Width						
	42	63	84	105	126	147	168
36	630	861	1,145	1,328	1,621	1,928	2,089
48	754	923	1,269	1,514	1,807	2,176	2,399
60	816	1,047	1,393	1,638	2,055	2,424	2,647
72	878	1,171	1,579	1,824	2,241	2,672	2,895
84	1,002	1,233	1,703	2,010	2,427	2,920	3,205
96	1,064	1,357	1,827	2,134	2,675	3,168	3,453
101	1,064	1,419	1,889	2,196	2,737	3,230	3,577

Series 18

Length Up To	Overall Finished Width						
	42	63	84	105	126	147	168
36	654	893	1,189	1,376	1,681	2,000	2,165
48	786	959	1,321	1,574	1,879	2,264	2,495
60	852	1,091	1,453	1,706	2,143	2,528	2,759
72	918	1,223	1,651	1,904	2,341	2,792	3,023
84	1,050	1,289	1,783	2,102	2,539	3,056	3,353
96	1,116	1,421	1,915	2,234	2,803	3,320	3,617
101	1,116	1,487	1,981	2,300	2,869	3,386	3,749

Series 19

Length Up To	Overall Finished Width						
	42	63	84	105	126	147	168
36	678	925	1,233	1,424	1,741	2,072	2,241
48	818	995	1,373	1,634	1,951	2,352	2,591
60	888	1,135	1,513	1,774	2,231	2,632	2,871
72	958	1,275	1,723	1,984	2,441	2,912	3,151
84	1,098	1,345	1,863	2,194	2,651	3,192	3,501
96	1,168	1,485	2,003	2,334	2,931	3,472	3,781
101	1,168	1,555	2,073	2,404	3,001	3,542	3,921

Series 20

Length Up To	Overall Finished Width						
	42	63	84	105	126	147	168
36	702	957	1,277	1,472	1,801	2,144	2,317
48	850	1,031	1,425	1,694	2,023	2,440	2,687
60	924	1,179	1,573	1,842	2,319	2,736	2,983
72	998	1,327	1,795	2,064	2,541	3,032	3,279
84	1,146	1,401	1,943	2,286	2,763	3,328	3,649
96	1,220	1,549	2,091	2,434	3,059	3,624	3,945
101	1,220	1,623	2,165	2,508	3,133	3,698	4,093

Series 21

Length Up To	Overall Finished Width						
	42	63	84	105	126	147	168
36	726	989	1,321	1,520	1,861	2,216	2,393
48	882	1,067	1,477	1,754	2,095	2,528	2,783
60	960	1,223	1,633	1,910	2,407	2,840	3,095
72	1,038	1,379	1,867	2,144	2,641	3,152	3,407
84	1,194	1,457	2,023	2,378	2,875	3,464	3,797
96	1,272	1,613	2,179	2,534	3,187	3,776	4,109
101	1,272	1,691	2,257	2,612	3,265	3,854	4,265

Series 22

Length Up To	Overall Finished Width						
	42	63	84	105	126	147	168
36	750	1,021	1,365	1,568	1,921	2,288	2,469
48	914	1,103	1,529	1,814	2,167	2,616	2,879
60	996	1,267	1,693	1,978	2,495	2,944	3,207
72	1,078	1,431	1,939	2,224	2,741	3,272	3,535
84	1,242	1,513	2,103	2,470	2,987	3,600	3,945
96	1,324	1,677	2,267	2,634	3,315	3,928	4,273
101	1,324	1,759	2,349	2,716	3,397	4,010	4,437

Series 23

Length Up To	Overall Finished Width						
	42	63	84	105	126	147	168
36	774	1,053	1,409	1,616	1,981	2,360	2,545
48	946	1,139	1,581	1,874	2,239	2,704	2,975
60	1,032	1,311	1,753	2,046	2,583	3,048	3,319
72	1,118	1,483	2,011	2,304	2,841	3,392	3,663
84	1,290	1,569	2,183	2,562	3,099	3,736	4,093
96	1,376	1,741	2,355	2,734	3,443	4,080	4,437
101	1,376	1,827	2,441	2,820	3,529	4,166	4,609

Series 24

Length Up To	Overall Finished Width						
	42	63	84	105	126	147	168
36	798	1,085	1,453	1,664	2,041	2,432	2,621
48	978	1,175	1,633	1,934	2,311	2,792	3,071
60	1,068	1,355	1,813	2,114	2,671	3,152	3,431
72	1,158	1,535	2,083	2,384	2,941	3,512	3,791
84	1,338	1,625	2,263	2,654	3,211	3,872	4,241
96	1,428	1,805	2,443	2,834	3,571	4,232	4,601
101	1,428	1,895	2,533	2,924	3,661	4,322	4,781

Series 25

Length Up To	Overall Finished Width						
	42	63	84	105	126	147	168
36	834	1,133	1,519	1,736	2,131	2,540	2,735
48	1,026	1,229	1,711	2,024	2,419	2,924	3,215
60	1,122	1,421	1,903	2,216	2,803	3,308	3,599
72	1,218	1,613	2,191	2,504	3,091	3,692	3,983
84	1,410	1,709	2,383	2,792	3,379	4,076	4,463
96	1,506	1,901	2,575	2,984	3,763	4,460	4,847
101	1,506	1,997	2,671	3,080	3,859	4,556	5,039

Series 26

Length Up To	Overall Finished Width						
	42	63	84	105	126	147	168
36	858	1,165	1,563	1,784	2,191	2,612	2,811
48	1,058	1,265	1,763	2,084	2,491	3,012	3,311
60	1,158	1,465	1,963	2,284	2,891	3,412	3,711
72	1,258	1,665	2,263	2,584	3,191	3,812	4,111
84	1,458	1,765	2,463	2,884	3,491	4,212	4,611
96	1,558	1,965	2,663	3,084	3,891	4,612	5,011
101	1,558	2,065	2,763	3,184	3,991	4,712	5,211

GROMMET DRAPERIES: 2 Fullness — Unlined

Sizes and series numbers beyond what is listed in the charts below are available—please submit these quote requests via fax or email.

Number of Widths						
2	3	4	4	5	6	7

Number of Widths						
2	3	4	4	5	6	7

Series 7							
Length Up To	Overall Finished Width						
	42	63	84	105	126	147	168
36	135	203	252	288	356	423	473
48	156	224	284	320	387	465	515
72	177	266	336	372	461	549	620
84	198	287	368	404	492	591	662
108	219	329	420	456	566	675	767
120	240	350	452	488	597	717	809
144	261	392	504	540	671	801	914

Series 8							
Length Up To	Overall Finished Width						
	42	63	84	105	126	147	168
36	150	225	282	318	393	468	525
48	176	251	321	357	432	520	577
72	202	303	386	422	523	624	707
84	228	329	425	461	562	676	759
108	254	381	490	526	653	780	889
120	280	407	529	565	692	832	941
144	306	459	594	630	783	936	1,071

Series 9							
Length Up To	Overall Finished Width						
	42	63	84	105	126	147	168
36	162	243	306	342	423	504	567
48	192	273	351	387	468	564	627
72	222	333	426	462	573	684	777
84	252	363	471	507	618	744	837
108	282	423	546	582	723	864	987
120	312	453	591	627	768	924	1,047
144	342	513	666	702	873	1,044	1,197

Series 10							
Length Up To	Overall Finished Width						
	42	63	84	105	126	147	168
36	174	261	330	366	453	540	609
48	208	295	381	417	504	608	677
72	242	363	466	502	623	744	847
84	276	397	517	553	674	812	915
108	310	465	602	638	793	948	1,085
120	344	499	653	689	844	1,016	1,153
144	378	567	738	774	963	1,152	1,323

Series 11							
Length Up To	Overall Finished Width						
	42	63	84	105	126	147	168
36	186	279	354	390	483	576	651
48	224	317	411	447	540	652	727
72	262	393	506	542	673	804	917
84	300	431	563	599	730	880	993
108	338	507	658	694	863	1,032	1,183
120	376	545	715	751	920	1,108	1,259
144	414	621	810	846	1,053	1,260	1,449

Series 12							
Length Up To	Overall Finished Width						
	42	63	84	105	126	147	168
36	198	297	378	414	513	612	693
48	240	339	441	477	576	696	777
72	282	423	546	582	723	864	987
84	324	465	609	645	786	948	1,071
108	366	549	714	750	933	1,116	1,281
120	408	591	777	813	996	1,200	1,365
144	450	675	882	918	1,143	1,368	1,575

Series 13							
Length Up To	Overall Finished Width						
	42	63	84	105	126	147	168
36	210	315	402	438	543	648	735
48	256	361	471	507	612	740	827
72	302	453	586	622	773	924	1,057
84	348	499	655	691	842	1,016	1,149
108	394	591	770	806	1,003	1,200	1,379
120	440	637	839	875	1,072	1,292	1,471
144	486	729	954	990	1,233	1,476	1,701

Series 14							
Length Up To	Overall Finished Width						
	42	63	84	105	126	147	168
36	222	333	426	462	573	684	777
48	272	383	501	537	648	784	877
72	322	483	626	662	823	984	1,127
84	372	533	701	737	898	1,084	1,227
108	422	633	826	862	1,073	1,284	1,477
120	472	683	901	937	1,148	1,384	1,577
144	522	783	1,026	1,062	1,323	1,584	1,827

Series 15							
Length Up To	Overall Finished Width						
	42	63	84	105	126	147	168
36	234	351	450	486	603	720	819
48	288	405	531	567	684	828	927
72	342	513	666	702	873	1,044	1,197
84	396	567	747	783	954	1,152	1,305
108	450	675	882	918	1,143	1,368	1,575
120	504	729	963	999	1,224	1,476	1,683
144	558	837	1,098	1,134	1,413	1,692	1,953

Series 16							
Length Up To	Overall Finished Width						
	42	63	84	105	126	147	168
36	246	369	474	510	633	756	861
48	304	427	561	597	720	872	977
72	362	543	706	742	923	1,104	1,267
84	420	601	793	829	1,010	1,220	1,383
108	478	717	938	974	1,213	1,452	1,673
120	536	775	1,025	1,061	1,300	1,568	1,789
144	594	891	1,170	1,206	1,503	1,800	2,079

GROMMET DRAPERIES: 2 Fullness — Unlined

Sizes and series numbers beyond what is listed in the charts below are available—please submit these quote requests via fax or email.

Number of Widths						
2	3	4	4	5	6	7

Number of Widths						
2	3	4	4	5	6	7

Series 17

Length Up To	Overall Finished Width						
	42	63	84	105	126	147	168
36	258	387	498	534	663	792	903
48	320	449	591	627	756	916	1,027
72	382	573	746	782	973	1,164	1,337
84	444	635	839	875	1,066	1,288	1,461
108	506	759	994	1,030	1,283	1,536	1,771
120	568	821	1,087	1,123	1,376	1,660	1,895
144	630	945	1,242	1,278	1,593	1,908	2,205

Series 18

Length Up To	Overall Finished Width						
	42	63	84	105	126	147	168
36	270	405	522	558	693	828	945
48	336	471	621	657	792	960	1,077
72	402	603	786	822	1,023	1,224	1,407
84	468	669	885	921	1,122	1,356	1,539
108	534	801	1,050	1,086	1,353	1,620	1,869
120	600	867	1,149	1,185	1,452	1,752	2,001
144	666	999	1,314	1,350	1,683	2,016	2,331

Series 19

Length Up To	Overall Finished Width						
	42	63	84	105	126	147	168
36	282	423	546	582	723	864	987
48	352	493	651	687	828	1,004	1,127
72	422	633	826	862	1,073	1,284	1,477
84	492	703	931	967	1,178	1,424	1,617
108	562	843	1,106	1,142	1,423	1,704	1,967
120	632	913	1,211	1,247	1,528	1,844	2,107
144	702	1,053	1,386	1,422	1,773	2,124	2,457

Series 20

Length Up To	Overall Finished Width						
	42	63	84	105	126	147	168
36	294	441	570	606	753	900	1,029
48	368	515	681	717	864	1,048	1,177
72	442	663	866	902	1,123	1,344	1,547
84	516	737	977	1,013	1,234	1,492	1,695
108	590	885	1,162	1,198	1,493	1,788	2,065
120	664	959	1,273	1,309	1,604	1,936	2,213
144	738	1,107	1,458	1,494	1,863	2,232	2,583

Series 21

Length Up To	Overall Finished Width						
	42	63	84	105	126	147	168
36	306	459	594	630	783	936	1,071
48	384	537	711	747	900	1,092	1,227
72	462	693	906	942	1,173	1,404	1,617
84	540	771	1,023	1,059	1,290	1,560	1,773
108	618	927	1,218	1,254	1,563	1,872	2,163
120	696	1,005	1,335	1,371	1,680	2,028	2,319
144	774	1,161	1,530	1,566	1,953	2,340	2,709

Series 22

Length Up To	Overall Finished Width						
	42	63	84	105	126	147	168
36	318	477	618	654	813	972	1,113
48	400	559	741	777	936	1,136	1,277
72	482	723	946	982	1,223	1,464	1,687
84	564	805	1,069	1,105	1,346	1,628	1,851
108	646	969	1,274	1,310	1,633	1,956	2,261
120	728	1,051	1,397	1,433	1,756	2,120	2,425
144	810	1,215	1,602	1,638	2,043	2,448	2,835

Series 23

Length Up To	Overall Finished Width						
	42	63	84	105	126	147	168
36	330	495	642	678	843	1,008	1,155
48	416	581	771	807	972	1,180	1,327
72	502	753	986	1,022	1,273	1,524	1,757
84	588	839	1,115	1,151	1,402	1,696	1,929
108	674	1,011	1,330	1,366	1,703	2,040	2,359
120	760	1,097	1,459	1,495	1,832	2,212	2,531
144	846	1,269	1,674	1,710	2,133	2,556	2,961

Series 24

Length Up To	Overall Finished Width						
	42	63	84	105	126	147	168
36	342	513	666	702	873	1,044	1,197
48	432	603	801	837	1,008	1,224	1,377
72	522	783	1,026	1,062	1,323	1,584	1,827
84	612	873	1,161	1,197	1,458	1,764	2,007
108	702	1,053	1,386	1,422	1,773	2,124	2,457
120	792	1,143	1,521	1,557	1,908	2,304	2,637
144	882	1,323	1,746	1,782	2,223	2,664	3,087

Series 25

Length Up To	Overall Finished Width						
	42	63	84	105	126	147	168
36	360	540	702	738	918	1,098	1,260
48	456	636	846	882	1,062	1,290	1,452
72	552	828	1,086	1,122	1,398	1,674	1,932
84	648	924	1,230	1,266	1,542	1,866	2,124
108	744	1,116	1,470	1,506	1,878	2,250	2,604
120	840	1,212	1,614	1,650	2,022	2,442	2,796
144	936	1,404	1,854	1,890	2,358	2,826	3,276

Series 26

Length Up To	Overall Finished Width						
	42	63	84	105	126	147	168
36	372	558	726	762	948	1,134	1,302
48	472	658	876	912	1,098	1,334	1,502
72	572	858	1,126	1,162	1,448	1,734	2,002
84	672	958	1,276	1,312	1,598	1,934	2,202
108	772	1,158	1,526	1,562	1,948	2,334	2,702
120	872	1,258	1,676	1,712	2,098	2,534	2,902
144	972	1,458	1,926	1,962	2,448	2,934	3,402

GROMMET DRAPERIES: 2 Fullness — Lined (Lining 01000)

Sizes and series numbers beyond what is listed in the charts below are available—please submit these quote requests via fax or email.

Number of Widths						
2	3	4	4	5	6	7

Number of Widths						
2	3	4	4	5	6	7

Series 7							
Length Up To	Overall Finished Width						
	42	63	84	105	126	147	168
36	256	369	476	557	665	793	885
48	277	390	507	589	697	835	927
60	288	411	528	610	739	877	980
72	298	432	560	641	770	919	1,032
84	319	453	591	673	802	961	1,074
96	330	474	612	694	844	1,003	1,127
101	330	485	623	704	854	1,014	1,148

Series 8							
Length Up To	Overall Finished Width						
	42	63	84	105	126	147	168
36	271	392	506	587	703	838	938
48	297	418	545	626	742	890	990
60	310	444	571	652	794	942	1,055
72	323	470	610	691	833	994	1,120
84	349	496	649	730	872	1,046	1,172
96	362	522	675	756	924	1,098	1,237
101	362	535	688	769	937	1,111	1,263

Series 9							
Length Up To	Overall Finished Width						
	42	63	84	105	126	147	168
36	283	410	530	611	733	874	980
48	313	440	575	656	778	934	1,040
60	328	470	605	686	838	994	1,115
72	343	500	650	731	883	1,054	1,190
84	373	530	695	776	928	1,114	1,250
96	388	560	725	806	988	1,174	1,325
101	388	575	740	821	1,003	1,189	1,355

Series 10							
Length Up To	Overall Finished Width						
	42	63	84	105	126	147	168
36	295	428	554	635	763	910	1,022
48	329	462	605	686	814	978	1,090
60	346	496	639	720	882	1,046	1,175
72	363	530	690	771	933	1,114	1,260
84	397	564	741	822	984	1,182	1,328
96	414	598	775	856	1,052	1,250	1,413
101	414	615	792	873	1,069	1,267	1,447

Series 11							
Length Up To	Overall Finished Width						
	42	63	84	105	126	147	168
36	307	446	578	659	793	946	1,064
48	345	484	635	716	850	1,022	1,140
60	364	522	673	754	926	1,098	1,235
72	383	560	730	811	983	1,174	1,330
84	421	598	787	868	1,040	1,250	1,406
96	440	636	825	906	1,116	1,326	1,501
101	440	655	844	925	1,135	1,345	1,539

Series 12							
Length Up To	Overall Finished Width						
	42	63	84	105	126	147	168
36	319	464	602	683	823	982	1,106
48	361	506	665	746	886	1,066	1,190
60	382	548	707	788	970	1,150	1,295
72	403	590	770	851	1,033	1,234	1,400
84	445	632	833	914	1,096	1,318	1,484
96	466	674	875	956	1,180	1,402	1,589
101	466	695	896	977	1,201	1,423	1,631

Series 13							
Length Up To	Overall Finished Width						
	42	63	84	105	126	147	168
36	331	482	626	707	853	1,018	1,148
48	377	528	695	776	922	1,110	1,240
60	400	574	741	822	1,014	1,202	1,355
72	423	620	810	891	1,083	1,294	1,470
84	469	666	879	960	1,152	1,386	1,562
96	492	712	925	1,006	1,244	1,478	1,677
101	492	735	948	1,029	1,267	1,501	1,723

Series 14							
Length Up To	Overall Finished Width						
	42	63	84	105	126	147	168
36	343	500	650	731	883	1,054	1,190
48	393	550	725	806	958	1,154	1,290
60	418	600	775	856	1,058	1,254	1,415
72	443	650	850	931	1,133	1,354	1,540
84	493	700	925	1,006	1,208	1,454	1,640
96	518	750	975	1,056	1,308	1,554	1,765
101	518	775	1,000	1,081	1,333	1,579	1,815

Series 15							
Length Up To	Overall Finished Width						
	42	63	84	105	126	147	168
36	355	518	674	755	913	1,090	1,232
48	409	572	755	836	994	1,198	1,340
60	436	626	809	890	1,102	1,306	1,475
72	463	680	890	971	1,183	1,414	1,610
84	517	734	971	1,052	1,264	1,522	1,718
96	544	788	1,025	1,106	1,372	1,630	1,853
101	544	815	1,052	1,133	1,399	1,657	1,907

Series 16							
Length Up To	Overall Finished Width						
	42	63	84	105	126	147	168
36	367	536	698	779	943	1,126	1,274
48	425	594	785	866	1,030	1,242	1,390
60	454	652	843	924	1,146	1,358	1,535
72	483	710	930	1,011	1,233	1,474	1,680
84	541	768	1,017	1,098	1,320	1,590	1,796
96	570	826	1,075	1,156	1,436	1,706	1,941
101	570	855	1,104	1,185	1,465	1,735	1,999

GROMMET DRAPERIES: 2 Fullness — Lined (Lining 01000)

Sizes and series numbers beyond what is listed in the charts below are available—please submit these quote requests via fax or email.

Number of Widths						
2	3	4	4	5	6	7

Number of Widths						
2	3	4	4	5	6	7

Series 17

Length Up To	Overall Finished Width						
	42	63	84	105	126	147	168
36	379	554	722	803	973	1,162	1,316
48	441	616	815	896	1,066	1,286	1,440
60	472	678	877	958	1,190	1,410	1,595
72	503	740	970	1,051	1,283	1,534	1,750
84	565	802	1,063	1,144	1,376	1,658	1,874
96	596	864	1,125	1,206	1,500	1,782	2,029
101	596	895	1,156	1,237	1,531	1,813	2,091

Series 18

Length Up To	Overall Finished Width						
	42	63	84	105	126	147	168
36	391	572	746	827	1,003	1,198	1,358
48	457	638	845	926	1,102	1,330	1,490
60	490	704	911	992	1,234	1,462	1,655
72	523	770	1,010	1,091	1,333	1,594	1,820
84	589	836	1,109	1,190	1,432	1,726	1,952
96	622	902	1,175	1,256	1,564	1,858	2,117
101	622	935	1,208	1,289	1,597	1,891	2,183

Series 19

Length Up To	Overall Finished Width						
	42	63	84	105	126	147	168
36	403	590	770	851	1,033	1,234	1,400
48	473	660	875	956	1,138	1,374	1,540
60	508	730	945	1,026	1,278	1,514	1,715
72	543	800	1,050	1,131	1,383	1,654	1,890
84	613	870	1,155	1,236	1,488	1,794	2,030
96	648	940	1,225	1,306	1,628	1,934	2,205
101	648	975	1,260	1,341	1,663	1,969	2,275

Series 20

Length Up To	Overall Finished Width						
	42	63	84	105	126	147	168
36	415	608	794	875	1,063	1,270	1,442
48	489	682	905	986	1,174	1,418	1,590
60	526	756	979	1,060	1,322	1,566	1,775
72	563	830	1,090	1,171	1,433	1,714	1,960
84	637	904	1,201	1,282	1,544	1,862	2,108
96	674	978	1,275	1,356	1,692	2,010	2,293
101	674	1,015	1,312	1,393	1,729	2,047	2,367

Series 21

Length Up To	Overall Finished Width						
	42	63	84	105	126	147	168
36	427	626	818	899	1,093	1,306	1,484
48	505	704	935	1,016	1,210	1,462	1,640
60	544	782	1,013	1,094	1,366	1,618	1,835
72	583	860	1,130	1,211	1,483	1,774	2,030
84	661	938	1,247	1,328	1,600	1,930	2,186
96	700	1,016	1,325	1,406	1,756	2,086	2,381
101	700	1,055	1,364	1,445	1,795	2,125	2,459

Series 22

Length Up To	Overall Finished Width						
	42	63	84	105	126	147	168
36	439	644	842	923	1,123	1,342	1,526
48	521	726	965	1,046	1,246	1,506	1,690
60	562	808	1,047	1,128	1,410	1,670	1,895
72	603	890	1,170	1,251	1,533	1,834	2,100
84	685	972	1,293	1,374	1,656	1,998	2,264
96	726	1,054	1,375	1,456	1,820	2,162	2,469
101	726	1,095	1,416	1,497	1,861	2,203	2,551

Series 23

Length Up To	Overall Finished Width						
	42	63	84	105	126	147	168
36	451	662	866	947	1,153	1,378	1,568
48	537	748	995	1,076	1,282	1,550	1,740
60	580	834	1,081	1,162	1,454	1,722	1,955
72	623	920	1,210	1,291	1,583	1,894	2,170
84	709	1,006	1,339	1,420	1,712	2,066	2,342
96	752	1,092	1,425	1,506	1,884	2,238	2,557
101	752	1,135	1,468	1,549	1,927	2,281	2,643

Series 24

Length Up To	Overall Finished Width						
	42	63	84	105	126	147	168
36	463	680	890	971	1,183	1,414	1,610
48	553	770	1,025	1,106	1,318	1,594	1,790
60	598	860	1,115	1,196	1,498	1,774	2,015
72	643	950	1,250	1,331	1,633	1,954	2,240
84	733	1,040	1,385	1,466	1,768	2,134	2,420
96	778	1,130	1,475	1,556	1,948	2,314	2,645
101	778	1,175	1,520	1,601	1,993	2,359	2,735

Series 25

Length Up To	Overall Finished Width						
	42	63	84	105	126	147	168
36	481	707	926	1,007	1,228	1,468	1,673
48	577	803	1,070	1,151	1,372	1,660	1,865
60	625	899	1,166	1,247	1,564	1,852	2,105
72	673	995	1,310	1,391	1,708	2,044	2,345
84	769	1,091	1,454	1,535	1,852	2,236	2,537
96	817	1,187	1,550	1,631	2,044	2,428	2,777
101	817	1,235	1,598	1,679	2,092	2,476	2,873

Series 26

Length Up To	Overall Finished Width						
	42	63	84	105	126	147	168
36	493	725	950	1,031	1,258	1,504	1,715
48	593	825	1,100	1,181	1,408	1,704	1,915
60	643	925	1,200	1,281	1,608	1,904	2,165
72	693	1,025	1,350	1,431	1,758	2,104	2,415
84	793	1,125	1,500	1,581	1,908	2,304	2,615
96	843	1,225	1,600	1,681	2,108	2,504	2,865
101	843	1,275	1,650	1,731	2,158	2,554	2,965

GROMMET DRAPERIES: 2.5 Fullness — Unlined

Sizes and series numbers beyond what is listed in the charts below are available—please submit these quote requests via fax or email.

Number of Widths							
2	3	4	5	6	7	8	

Number of Widths							
2	3	4	5	6	7	8	

Series 7								
Length Up To	Overall Finished Width							
	42	63	84	105	126	147	168	
36	135	203	252	320	387	455	504	
48	156	224	284	351	429	497	557	
72	177	266	336	425	513	602	672	
84	198	287	368	456	555	644	725	
108	219	329	420	530	639	749	840	
120	240	350	452	561	681	791	893	
144	261	392	504	635	765	896	1,008	

Series 8								
Length Up To	Overall Finished Width							
	42	63	84	105	126	147	168	
36	150	225	282	357	432	507	564	
48	176	251	321	396	484	559	629	
72	202	303	386	487	588	689	772	
84	228	329	425	526	640	741	837	
108	254	381	490	617	744	871	980	
120	280	407	529	656	796	923	1,045	
144	306	459	594	747	900	1,053	1,188	

Series 9								
Length Up To	Overall Finished Width							
	42	63	84	105	126	147	168	
36	162	243	306	387	468	549	612	
48	192	273	351	432	528	609	687	
72	222	333	426	537	648	759	852	
84	252	363	471	582	708	819	927	
108	282	423	546	687	828	969	1,092	
120	312	453	591	732	888	1,029	1,167	
144	342	513	666	837	1,008	1,179	1,332	

Series 10								
Length Up To	Overall Finished Width							
	42	63	84	105	126	147	168	
36	174	261	330	417	504	591	660	
48	208	295	381	468	572	659	745	
72	242	363	466	587	708	829	932	
84	276	397	517	638	776	897	1,017	
108	310	465	602	757	912	1,067	1,204	
120	344	499	653	808	980	1,135	1,289	
144	378	567	738	927	1,116	1,305	1,476	

Series 11								
Length Up To	Overall Finished Width							
	42	63	84	105	126	147	168	
36	186	279	354	447	540	633	708	
48	224	317	411	504	616	709	803	
72	262	393	506	637	768	899	1,012	
84	300	431	563	694	844	975	1,107	
108	338	507	658	827	996	1,165	1,316	
120	376	545	715	884	1,072	1,241	1,411	
144	414	621	810	1,017	1,224	1,431	1,620	

Series 12								
Length Up To	Overall Finished Width							
	42	63	84	105	126	147	168	
36	198	297	378	477	576	675	756	
48	240	339	441	540	660	759	861	
72	282	423	546	687	828	969	1,092	
84	324	465	609	750	912	1,053	1,197	
108	366	549	714	897	1,080	1,263	1,428	
120	408	591	777	960	1,164	1,347	1,533	
144	450	675	882	1,107	1,332	1,557	1,764	

Series 13								
Length Up To	Overall Finished Width							
	42	63	84	105	126	147	168	
36	210	315	402	507	612	717	804	
48	256	361	471	576	704	809	919	
72	302	453	586	737	888	1,039	1,172	
84	348	499	655	806	980	1,131	1,287	
108	394	591	770	967	1,164	1,361	1,540	
120	440	637	839	1,036	1,256	1,453	1,655	
144	486	729	954	1,197	1,440	1,683	1,908	

Series 14								
Length Up To	Overall Finished Width							
	42	63	84	105	126	147	168	
36	222	333	426	537	648	759	852	
48	272	383	501	612	748	859	977	
72	322	483	626	787	948	1,109	1,252	
84	372	533	701	862	1,048	1,209	1,377	
108	422	633	826	1,037	1,248	1,459	1,652	
120	472	683	901	1,112	1,348	1,559	1,777	
144	522	783	1,026	1,287	1,548	1,809	2,052	

Series 15								
Length Up To	Overall Finished Width							
	42	63	84	105	126	147	168	
36	234	351	450	567	684	801	900	
48	288	405	531	648	792	909	1,035	
72	342	513	666	837	1,008	1,179	1,332	
84	396	567	747	918	1,116	1,287	1,467	
108	450	675	882	1,107	1,332	1,557	1,764	
120	504	729	963	1,188	1,440	1,665	1,899	
144	558	837	1,098	1,377	1,656	1,935	2,196	

Series 16								
Length Up To	Overall Finished Width							
	42	63	84	105	126	147	168	
36	246	369	474	597	720	843	948	
48	304	427	561	684	836	959	1,093	
72	362	543	706	887	1,068	1,249	1,412	
84	420	601	793	974	1,184	1,365	1,557	
108	478	717	938	1,177	1,416	1,655	1,876	
120	536	775	1,025	1,264	1,532	1,771	2,021	
144	594	891	1,170	1,467	1,764	2,061	2,340	

GROMMET DRAPERIES: 2.5 Fullness — Unlined

Sizes and series numbers beyond what is listed in the charts below are available—please submit these quote requests via fax or email.

Number of Widths							
2	3	4	5	6	7	8	

Number of Widths							
2	3	4	5	6	7	8	

Series 17

Length Up To	Overall Finished Width						
	42	63	84	105	126	147	168
36	258	387	498	627	756	885	996
48	320	449	591	720	880	1,009	1,151
72	382	573	746	937	1,128	1,319	1,492
84	444	635	839	1,030	1,252	1,443	1,647
108	506	759	994	1,247	1,500	1,753	1,988
120	568	821	1,087	1,340	1,624	1,877	2,143
144	630	945	1,242	1,557	1,872	2,187	2,484

Series 18

Length Up To	Overall Finished Width						
	42	63	84	105	126	147	168
36	270	405	522	657	792	927	1,044
48	336	471	621	756	924	1,059	1,209
72	402	603	786	987	1,188	1,389	1,572
84	468	669	885	1,086	1,320	1,521	1,737
108	534	801	1,050	1,317	1,584	1,851	2,100
120	600	867	1,149	1,416	1,716	1,983	2,265
144	666	999	1,314	1,647	1,980	2,313	2,628

Series 19

Length Up To	Overall Finished Width						
	42	63	84	105	126	147	168
36	282	423	546	687	828	969	1,092
48	352	493	651	792	968	1,109	1,267
72	422	633	826	1,037	1,248	1,459	1,652
84	492	703	931	1,142	1,388	1,599	1,827
108	562	843	1,106	1,387	1,668	1,949	2,212
120	632	913	1,211	1,492	1,808	2,089	2,387
144	702	1,053	1,386	1,737	2,088	2,439	2,772

Series 20

Length Up To	Overall Finished Width						
	42	63	84	105	126	147	168
36	294	441	570	717	864	1,011	1,140
48	368	515	681	828	1,012	1,159	1,325
72	442	663	866	1,087	1,308	1,529	1,732
84	516	737	977	1,198	1,456	1,677	1,917
108	590	885	1,162	1,457	1,752	2,047	2,324
120	664	959	1,273	1,568	1,900	2,195	2,509
144	738	1,107	1,458	1,827	2,196	2,565	2,916

Series 21

Length Up To	Overall Finished Width						
	42	63	84	105	126	147	168
36	306	459	594	747	900	1,053	1,188
48	384	537	711	864	1,056	1,209	1,383
72	462	693	906	1,137	1,368	1,599	1,812
84	540	771	1,023	1,254	1,524	1,755	2,007
108	618	927	1,218	1,527	1,836	2,145	2,436
120	696	1,005	1,335	1,644	1,992	2,301	2,631
144	774	1,161	1,530	1,917	2,304	2,691	3,060

Series 22

Length Up To	Overall Finished Width						
	42	63	84	105	126	147	168
36	318	477	618	777	936	1,095	1,236
48	400	559	741	900	1,100	1,259	1,441
72	482	723	946	1,187	1,428	1,669	1,892
84	564	805	1,069	1,310	1,592	1,833	2,097
108	646	969	1,274	1,597	1,920	2,243	2,548
120	728	1,051	1,397	1,720	2,084	2,407	2,753
144	810	1,215	1,602	2,007	2,412	2,817	3,204

Series 23

Length Up To	Overall Finished Width						
	42	63	84	105	126	147	168
36	330	495	642	807	972	1,137	1,284
48	416	581	771	936	1,144	1,309	1,499
72	502	753	986	1,237	1,488	1,739	1,972
84	588	839	1,115	1,366	1,660	1,911	2,187
108	674	1,011	1,330	1,667	2,004	2,341	2,660
120	760	1,097	1,459	1,796	2,176	2,513	2,875
144	846	1,269	1,674	2,097	2,520	2,943	3,348

Series 24

Length Up To	Overall Finished Width						
	42	63	84	105	126	147	168
36	342	513	666	837	1,008	1,179	1,332
48	432	603	801	972	1,188	1,359	1,557
72	522	783	1,026	1,287	1,548	1,809	2,052
84	612	873	1,161	1,422	1,728	1,989	2,277
108	702	1,053	1,386	1,737	2,088	2,439	2,772
120	792	1,143	1,521	1,872	2,268	2,619	2,997
144	882	1,323	1,746	2,187	2,628	3,069	3,492

Series 25

Length Up To	Overall Finished Width						
	42	63	84	105	126	147	168
36	360	540	702	882	1,062	1,242	1,404
48	456	636	846	1,026	1,254	1,434	1,644
72	552	828	1,086	1,362	1,638	1,914	2,172
84	648	924	1,230	1,506	1,830	2,106	2,412
108	744	1,116	1,470	1,842	2,214	2,586	2,940
120	840	1,212	1,614	1,986	2,406	2,778	3,180
144	936	1,404	1,854	2,322	2,790	3,258	3,708

Series 26

Length Up To	Overall Finished Width						
	42	63	84	105	126	147	168
36	372	558	726	912	1,098	1,284	1,452
48	472	658	876	1,062	1,298	1,484	1,702
72	572	858	1,126	1,412	1,698	1,984	2,252
84	672	958	1,276	1,562	1,898	2,184	2,502
108	772	1,158	1,526	1,912	2,298	2,684	3,052
120	872	1,258	1,676	2,062	2,498	2,884	3,302
144	972	1,458	1,926	2,412	2,898	3,384	3,852

GROMMET DRAPERIES: 2.5 Fullness — Lined (Lining 01000)

Sizes and series numbers beyond what is listed in the charts below are available—please submit these quote requests via fax or email.

Number of Widths							
2	3	4	5	6	7	8	

Number of Widths							
2	3	4	5	6	7	8	

Series 7								
Length Up To	Overall Finished Width							
	42	63	84	105	126	147	168	
36	280	413	524	652	784	912	1,023	
48	301	434	555	683	826	954	1,076	
60	312	455	576	725	868	1,006	1,128	
72	322	476	608	757	910	1,059	1,191	
84	343	497	639	788	952	1,101	1,244	
96	354	518	660	830	994	1,153	1,296	
101	354	528	671	841	1,004	1,174	1,317	

Series 8								
Length Up To	Overall Finished Width							
	42	63	84	105	126	147	168	
36	295	435	554	689	829	964	1,083	
48	321	461	593	728	881	1,016	1,148	
60	334	487	619	780	933	1,081	1,213	
72	347	513	658	819	985	1,146	1,291	
84	373	539	697	858	1,037	1,198	1,356	
96	386	565	723	910	1,089	1,263	1,421	
101	386	578	736	923	1,102	1,289	1,447	

Series 9								
Length Up To	Overall Finished Width							
	42	63	84	105	126	147	168	
36	307	453	578	719	865	1,006	1,131	
48	337	483	623	764	925	1,066	1,206	
60	352	513	653	824	985	1,141	1,281	
72	367	543	698	869	1,045	1,216	1,371	
84	397	573	743	914	1,105	1,276	1,446	
96	412	603	773	974	1,165	1,351	1,521	
101	412	618	788	989	1,180	1,381	1,551	

Series 10								
Length Up To	Overall Finished Width							
	42	63	84	105	126	147	168	
36	319	471	602	749	901	1,048	1,179	
48	353	505	653	800	969	1,116	1,264	
60	370	539	687	868	1,037	1,201	1,349	
72	387	573	738	919	1,105	1,286	1,451	
84	421	607	789	970	1,173	1,354	1,536	
96	438	641	823	1,038	1,241	1,439	1,621	
101	438	658	840	1,055	1,258	1,473	1,655	

Series 11								
Length Up To	Overall Finished Width							
	42	63	84	105	126	147	168	
36	331	489	626	779	937	1,090	1,227	
48	369	527	683	836	1,013	1,166	1,322	
60	388	565	721	912	1,089	1,261	1,417	
72	407	603	778	969	1,165	1,356	1,531	
84	445	641	835	1,026	1,241	1,432	1,626	
96	464	679	873	1,102	1,317	1,527	1,721	
101	464	698	892	1,121	1,336	1,565	1,759	

Series 12								
Length Up To	Overall Finished Width							
	42	63	84	105	126	147	168	
36	343	507	650	809	973	1,132	1,275	
48	385	549	713	872	1,057	1,216	1,380	
60	406	591	755	956	1,141	1,321	1,485	
72	427	633	818	1,019	1,225	1,426	1,611	
84	469	675	881	1,082	1,309	1,510	1,716	
96	490	717	923	1,166	1,393	1,615	1,821	
101	490	738	944	1,187	1,414	1,657	1,863	

Series 13								
Length Up To	Overall Finished Width							
	42	63	84	105	126	147	168	
36	355	525	674	839	1,009	1,174	1,323	
48	401	571	743	908	1,101	1,266	1,438	
60	424	617	789	1,000	1,193	1,381	1,553	
72	447	663	858	1,069	1,285	1,496	1,691	
84	493	709	927	1,138	1,377	1,588	1,806	
96	516	755	973	1,230	1,469	1,703	1,921	
101	516	778	996	1,253	1,492	1,749	1,967	

Series 14								
Length Up To	Overall Finished Width							
	42	63	84	105	126	147	168	
36	367	543	698	869	1,045	1,216	1,371	
48	417	593	773	944	1,145	1,316	1,496	
60	442	643	823	1,044	1,245	1,441	1,621	
72	467	693	898	1,119	1,345	1,566	1,771	
84	517	743	973	1,194	1,445	1,666	1,896	
96	542	793	1,023	1,294	1,545	1,791	2,021	
101	542	818	1,048	1,319	1,570	1,841	2,071	

Series 15								
Length Up To	Overall Finished Width							
	42	63	84	105	126	147	168	
36	379	561	722	899	1,081	1,258	1,419	
48	433	615	803	980	1,189	1,366	1,554	
60	460	669	857	1,088	1,297	1,501	1,689	
72	487	723	938	1,169	1,405	1,636	1,851	
84	541	777	1,019	1,250	1,513	1,744	1,986	
96	568	831	1,073	1,358	1,621	1,879	2,121	
101	568	858	1,100	1,385	1,648	1,933	2,175	

Series 16								
Length Up To	Overall Finished Width							
	42	63	84	105	126	147	168	
36	391	579	746	929	1,117	1,300	1,467	
48	449	637	833	1,016	1,233	1,416	1,612	
60	478	695	891	1,132	1,349	1,561	1,757	
72	507	753	978	1,219	1,465	1,706	1,931	
84	565	811	1,065	1,306	1,581	1,822	2,076	
96	594	869	1,123	1,422	1,697	1,967	2,221	
101	594	898	1,152	1,451	1,726	2,025	2,279	

GROMMET DRAPERIES: 2.5 Fullness — Lined (Lining 01000)

Sizes and series numbers beyond what is listed in the charts below are available—please submit these quote requests via fax or email.

Number of Widths							
2	3	4	5	6	7	8	

Number of Widths							
2	3	4	5	6	7	8	

Series 17

Length Up To	Overall Finished Width						
	42	63	84	105	126	147	168
36	403	597	770	959	1,153	1,342	1,515
48	465	659	863	1,052	1,277	1,466	1,670
60	496	721	925	1,176	1,401	1,621	1,825
72	527	783	1,018	1,269	1,525	1,776	2,011
84	589	845	1,111	1,362	1,649	1,900	2,166
96	620	907	1,173	1,486	1,773	2,055	2,321
101	620	938	1,204	1,517	1,804	2,117	2,383

Series 18

Length Up To	Overall Finished Width						
	42	63	84	105	126	147	168
36	415	615	794	989	1,189	1,384	1,563
48	481	681	893	1,088	1,321	1,516	1,728
60	514	747	959	1,220	1,453	1,681	1,893
72	547	813	1,058	1,319	1,585	1,846	2,091
84	613	879	1,157	1,418	1,717	1,978	2,256
96	646	945	1,223	1,550	1,849	2,143	2,421
101	646	978	1,256	1,583	1,882	2,209	2,487

Series 19

Length Up To	Overall Finished Width						
	42	63	84	105	126	147	168
36	427	633	818	1,019	1,225	1,426	1,611
48	497	703	923	1,124	1,365	1,566	1,786
60	532	773	993	1,264	1,505	1,741	1,961
72	567	843	1,098	1,369	1,645	1,916	2,171
84	637	913	1,203	1,474	1,785	2,056	2,346
96	672	983	1,273	1,614	1,925	2,231	2,521
101	672	1,018	1,308	1,649	1,960	2,301	2,591

Series 20

Length Up To	Overall Finished Width						
	42	63	84	105	126	147	168
36	439	651	842	1,049	1,261	1,468	1,659
48	513	725	953	1,160	1,409	1,616	1,844
60	550	799	1,027	1,308	1,557	1,801	2,029
72	587	873	1,138	1,419	1,705	1,986	2,251
84	661	947	1,249	1,530	1,853	2,134	2,436
96	698	1,021	1,323	1,678	2,001	2,319	2,621
101	698	1,058	1,360	1,715	2,038	2,393	2,695

Series 21

Length Up To	Overall Finished Width						
	42	63	84	105	126	147	168
36	451	669	866	1,079	1,297	1,510	1,707
48	529	747	983	1,196	1,453	1,666	1,902
60	568	825	1,061	1,352	1,609	1,861	2,097
72	607	903	1,178	1,469	1,765	2,056	2,331
84	685	981	1,295	1,586	1,921	2,212	2,526
96	724	1,059	1,373	1,742	2,077	2,407	2,721
101	724	1,098	1,412	1,781	2,116	2,485	2,799

Series 22

Length Up To	Overall Finished Width						
	42	63	84	105	126	147	168
36	463	687	890	1,109	1,333	1,552	1,755
48	545	769	1,013	1,232	1,497	1,716	1,960
60	586	851	1,095	1,396	1,661	1,921	2,165
72	627	933	1,218	1,519	1,825	2,126	2,411
84	709	1,015	1,341	1,642	1,989	2,290	2,616
96	750	1,097	1,423	1,806	2,153	2,495	2,821
101	750	1,138	1,464	1,847	2,194	2,577	2,903

Series 23

Length Up To	Overall Finished Width						
	42	63	84	105	126	147	168
36	475	705	914	1,139	1,369	1,594	1,803
48	561	791	1,043	1,268	1,541	1,766	2,018
60	604	877	1,129	1,440	1,713	1,981	2,233
72	647	963	1,258	1,569	1,885	2,196	2,491
84	733	1,049	1,387	1,698	2,057	2,368	2,706
96	776	1,135	1,473	1,870	2,229	2,583	2,921
101	776	1,178	1,516	1,913	2,272	2,669	3,007

Series 24

Length Up To	Overall Finished Width						
	42	63	84	105	126	147	168
36	487	723	938	1,169	1,405	1,636	1,851
48	577	813	1,073	1,304	1,585	1,816	2,076
60	622	903	1,163	1,484	1,765	2,041	2,301
72	667	993	1,298	1,619	1,945	2,266	2,571
84	757	1,083	1,433	1,754	2,125	2,446	2,796
96	802	1,173	1,523	1,934	2,305	2,671	3,021
101	802	1,218	1,568	1,979	2,350	2,761	3,111

Series 25

Length Up To	Overall Finished Width						
	42	63	84	105	126	147	168
36	505	750	974	1,214	1,459	1,699	1,923
48	601	846	1,118	1,358	1,651	1,891	2,163
60	649	942	1,214	1,550	1,843	2,131	2,403
72	697	1,038	1,358	1,694	2,035	2,371	2,691
84	793	1,134	1,502	1,838	2,227	2,563	2,931
96	841	1,230	1,598	2,030	2,419	2,803	3,171
101	841	1,278	1,646	2,078	2,467	2,899	3,267

Series 26

Length Up To	Overall Finished Width						
	42	63	84	105	126	147	168
36	517	768	998	1,244	1,495	1,741	1,971
48	617	868	1,148	1,394	1,695	1,941	2,221
60	667	968	1,248	1,594	1,895	2,191	2,471
72	717	1,068	1,398	1,744	2,095	2,441	2,771
84	817	1,168	1,548	1,894	2,295	2,641	3,021
96	867	1,268	1,648	2,094	2,495	2,891	3,271
101	867	1,318	1,698	2,144	2,545	2,991	3,371

GROMMET DRAPERIES: 3 Fullness — Unlined

Sizes and series numbers beyond what is listed in the charts below are available—please submit these quote requests via fax or email.

Number of Widths						
3	4	5	6	8	9	10

Number of Widths						
3	4	5	6	8	9	10

Series 7							
Length Up To	Overall Finished Width						
	42	63	84	105	126	147	168
36	167	234	284	351	450	507	557
48	188	266	315	393	503	570	630
72	230	318	389	477	618	696	767
84	251	350	420	519	671	759	840
108	293	402	494	603	786	885	977
120	314	434	525	645	839	948	1,050
144	356	486	599	729	954	1,074	1,187

Series 8							
Length Up To	Overall Finished Width						
	42	63	84	105	126	147	168
36	189	264	321	396	510	572	629
48	215	303	360	448	575	650	720
72	267	368	451	552	718	806	889
84	293	407	490	604	783	884	980
108	345	472	581	708	926	1,040	1,149
120	371	511	620	760	991	1,118	1,240
144	423	576	711	864	1,134	1,274	1,409

Series 9							
Length Up To	Overall Finished Width						
	42	63	84	105	126	147	168
36	207	288	351	432	558	624	687
48	237	333	396	492	633	714	792
72	297	408	501	612	798	894	987
84	327	453	546	672	873	984	1,092
108	387	528	651	792	1,038	1,164	1,287
120	417	573	696	852	1,113	1,254	1,392
144	477	648	801	972	1,278	1,434	1,587

Series 10							
Length Up To	Overall Finished Width						
	42	63	84	105	126	147	168
36	225	312	381	468	606	676	745
48	259	363	432	536	691	778	864
72	327	448	551	672	878	982	1,085
84	361	499	602	740	963	1,084	1,204
108	429	584	721	876	1,150	1,288	1,425
120	463	635	772	944	1,235	1,390	1,544
144	531	720	891	1,080	1,422	1,594	1,765

Series 11							
Length Up To	Overall Finished Width						
	42	63	84	105	126	147	168
36	243	336	411	504	654	728	803
48	281	393	468	580	749	842	936
72	357	488	601	732	958	1,070	1,183
84	395	545	658	808	1,053	1,184	1,316
108	471	640	791	960	1,262	1,412	1,563
120	509	697	848	1,036	1,357	1,526	1,696
144	585	792	981	1,188	1,566	1,754	1,943

Series 12							
Length Up To	Overall Finished Width						
	42	63	84	105	126	147	168
36	261	360	441	540	702	780	861
48	303	423	504	624	807	906	1,008
72	387	528	651	792	1,038	1,158	1,281
84	429	591	714	876	1,143	1,284	1,428
108	513	696	861	1,044	1,374	1,536	1,701
120	555	759	924	1,128	1,479	1,662	1,848
144	639	864	1,071	1,296	1,710	1,914	2,121

Series 13							
Length Up To	Overall Finished Width						
	42	63	84	105	126	147	168
36	279	384	471	576	750	832	919
48	325	453	540	668	865	970	1,080
72	417	568	701	852	1,118	1,246	1,379
84	463	637	770	944	1,233	1,384	1,540
108	555	752	931	1,128	1,486	1,660	1,839
120	601	821	1,000	1,220	1,601	1,798	2,000
144	693	936	1,161	1,404	1,854	2,074	2,299

Series 14							
Length Up To	Overall Finished Width						
	42	63	84	105	126	147	168
36	297	408	501	612	798	884	977
48	347	483	576	712	923	1,034	1,152
72	447	608	751	912	1,198	1,334	1,477
84	497	683	826	1,012	1,323	1,484	1,652
108	597	808	1,001	1,212	1,598	1,784	1,977
120	647	883	1,076	1,312	1,723	1,934	2,152
144	747	1,008	1,251	1,512	1,998	2,234	2,477

Series 15							
Length Up To	Overall Finished Width						
	42	63	84	105	126	147	168
36	315	432	531	648	846	936	1,035
48	369	513	612	756	981	1,098	1,224
72	477	648	801	972	1,278	1,422	1,575
84	531	729	882	1,080	1,413	1,584	1,764
108	639	864	1,071	1,296	1,710	1,908	2,115
120	693	945	1,152	1,404	1,845	2,070	2,304
144	801	1,080	1,341	1,620	2,142	2,394	2,655

Series 16							
Length Up To	Overall Finished Width						
	42	63	84	105	126	147	168
36	333	456	561	684	894	988	1,093
48	391	543	648	800	1,039	1,162	1,296
72	507	688	851	1,032	1,358	1,510	1,673
84	565	775	938	1,148	1,503	1,684	1,876
108	681	920	1,141	1,380	1,822	2,032	2,253
120	739	1,007	1,228	1,496	1,967	2,206	2,456
144	855	1,152	1,431	1,728	2,286	2,554	2,833

GROMMET DRAPERIES: 3 Fullness — Unlined

Sizes and series numbers beyond what is listed in the charts below are available—please submit these quote requests via fax or email.

Number of Widths						
3	4	5	6	8	9	10

Number of Widths						
3	4	5	6	8	9	10

Series 17

Length Up To	Overall Finished Width						
	42	63	84	105	126	147	168
36	351	480	591	720	942	1,040	1,151
48	413	573	684	844	1,097	1,226	1,368
72	537	728	901	1,092	1,438	1,598	1,771
84	599	821	994	1,216	1,593	1,784	1,988
108	723	976	1,211	1,464	1,934	2,156	2,391
120	785	1,069	1,304	1,588	2,089	2,342	2,608
144	909	1,224	1,521	1,836	2,430	2,714	3,011

Series 18

Length Up To	Overall Finished Width						
	42	63	84	105	126	147	168
36	369	504	621	756	990	1,092	1,209
48	435	603	720	888	1,155	1,290	1,440
72	567	768	951	1,152	1,518	1,686	1,869
84	633	867	1,050	1,284	1,683	1,884	2,100
108	765	1,032	1,281	1,548	2,046	2,280	2,529
120	831	1,131	1,380	1,680	2,211	2,478	2,760
144	963	1,296	1,611	1,944	2,574	2,874	3,189

Series 19

Length Up To	Overall Finished Width						
	42	63	84	105	126	147	168
36	387	528	651	792	1,038	1,144	1,267
48	457	633	756	932	1,213	1,354	1,512
72	597	808	1,001	1,212	1,598	1,774	1,967
84	667	913	1,106	1,352	1,773	1,984	2,212
108	807	1,088	1,351	1,632	2,158	2,404	2,667
120	877	1,193	1,456	1,772	2,333	2,614	2,912
144	1,017	1,368	1,701	2,052	2,718	3,034	3,367

Series 20

Length Up To	Overall Finished Width						
	42	63	84	105	126	147	168
36	405	552	681	828	1,086	1,196	1,325
48	479	663	792	976	1,271	1,418	1,584
72	627	848	1,051	1,272	1,678	1,862	2,065
84	701	959	1,162	1,420	1,863	2,084	2,324
108	849	1,144	1,421	1,716	2,270	2,528	2,805
120	923	1,255	1,532	1,864	2,455	2,750	3,064
144	1,071	1,440	1,791	2,160	2,862	3,194	3,545

Series 21

Length Up To	Overall Finished Width						
	42	63	84	105	126	147	168
36	423	576	711	864	1,134	1,248	1,383
48	501	693	828	1,020	1,329	1,482	1,656
72	657	888	1,101	1,332	1,758	1,950	2,163
84	735	1,005	1,218	1,488	1,953	2,184	2,436
108	891	1,200	1,491	1,800	2,382	2,652	2,943
120	969	1,317	1,608	1,956	2,577	2,886	3,216
144	1,125	1,512	1,881	2,268	3,006	3,354	3,723

Series 22

Length Up To	Overall Finished Width						
	42	63	84	105	126	147	168
36	441	600	741	900	1,182	1,300	1,441
48	523	723	864	1,064	1,387	1,546	1,728
72	687	928	1,151	1,392	1,838	2,038	2,261
84	769	1,051	1,274	1,556	2,043	2,284	2,548
108	933	1,256	1,561	1,884	2,494	2,776	3,081
120	1,015	1,379	1,684	2,048	2,699	3,022	3,368
144	1,179	1,584	1,971	2,376	3,150	3,514	3,901

Series 23

Length Up To	Overall Finished Width						
	42	63	84	105	126	147	168
36	459	624	771	936	1,230	1,352	1,499
48	545	753	900	1,108	1,445	1,610	1,800
72	717	968	1,201	1,452	1,918	2,126	2,359
84	803	1,097	1,330	1,624	2,133	2,384	2,660
108	975	1,312	1,631	1,968	2,606	2,900	3,219
120	1,061	1,441	1,760	2,140	2,821	3,158	3,520
144	1,233	1,656	2,061	2,484	3,294	3,674	4,079

Series 24

Length Up To	Overall Finished Width						
	42	63	84	105	126	147	168
36	477	648	801	972	1,278	1,404	1,557
48	567	783	936	1,152	1,503	1,674	1,872
72	747	1,008	1,251	1,512	1,998	2,214	2,457
84	837	1,143	1,386	1,692	2,223	2,484	2,772
108	1,017	1,368	1,701	2,052	2,718	3,024	3,357
120	1,107	1,503	1,836	2,232	2,943	3,294	3,672
144	1,287	1,728	2,151	2,592	3,438	3,834	4,257

Series 25

Length Up To	Overall Finished Width						
	42	63	84	105	126	147	168
36	504	684	846	1,026	1,350	1,482	1,644
48	600	828	990	1,218	1,590	1,770	1,980
72	792	1,068	1,326	1,602	2,118	2,346	2,604
84	888	1,212	1,470	1,794	2,358	2,634	2,940
108	1,080	1,452	1,806	2,178	2,886	3,210	3,564
120	1,176	1,596	1,950	2,370	3,126	3,498	3,900
144	1,368	1,836	2,286	2,754	3,654	4,074	4,524

Series 26

Length Up To	Overall Finished Width						
	42	63	84	105	126	147	168
36	522	708	876	1,062	1,398	1,534	1,702
48	622	858	1,026	1,262	1,648	1,834	2,052
72	822	1,108	1,376	1,662	2,198	2,434	2,702
84	922	1,258	1,526	1,862	2,448	2,734	3,052
108	1,122	1,508	1,876	2,262	2,998	3,334	3,702
120	1,222	1,658	2,026	2,462	3,248	3,634	4,052
144	1,422	1,908	2,376	2,862	3,798	4,234	4,702

GROMMET DRAPERIES: 3 Fullness — Lined (Lining 01000)

Sizes and series numbers beyond what is listed in the charts below are available—please submit these quote requests via fax or email.

Number of Widths						
3	4	5	6	8	9	10

Number of Widths						
3	4	5	6	8	9	10

Series 7

Length Up To	Overall Finished Width						
	42	63	84	105	126	147	168
36	336	483	599	751	914	1,051	1,167
48	357	515	630	793	967	1,114	1,241
60	378	536	672	835	1,019	1,177	1,314
72	399	567	704	877	1,082	1,240	1,377
84	420	599	735	919	1,135	1,303	1,451
96	441	620	777	961	1,187	1,366	1,524
101	451	630	788	971	1,208	1,398	1,545

Series 8

Length Up To	Overall Finished Width						
	42	63	84	105	126	147	168
36	358	513	636	796	974	1,116	1,240
48	384	552	675	848	1,039	1,194	1,331
60	410	578	727	900	1,104	1,272	1,422
72	436	617	766	952	1,182	1,350	1,500
84	462	656	805	1,004	1,247	1,428	1,591
96	488	682	857	1,056	1,312	1,506	1,682
101	501	695	870	1,069	1,338	1,545	1,708

Series 9

Length Up To	Overall Finished Width						
	42	63	84	105	126	147	168
36	376	537	666	832	1,022	1,168	1,298
48	406	582	711	892	1,097	1,258	1,403
60	436	612	771	952	1,172	1,348	1,508
72	466	657	816	1,012	1,262	1,438	1,598
84	496	702	861	1,072	1,337	1,528	1,703
96	526	732	921	1,132	1,412	1,618	1,808
101	541	747	936	1,147	1,442	1,663	1,838

Series 10

Length Up To	Overall Finished Width						
	42	63	84	105	126	147	168
36	394	561	696	868	1,070	1,220	1,356
48	428	612	747	936	1,155	1,322	1,475
60	462	646	815	1,004	1,240	1,424	1,594
72	496	697	866	1,072	1,342	1,526	1,696
84	530	748	917	1,140	1,427	1,628	1,815
96	564	782	985	1,208	1,512	1,730	1,934
101	581	799	1,002	1,225	1,546	1,781	1,968

Series 11

Length Up To	Overall Finished Width						
	42	63	84	105	126	147	168
36	412	585	726	904	1,118	1,272	1,414
48	450	642	783	980	1,213	1,386	1,547
60	488	680	859	1,056	1,308	1,500	1,680
72	526	737	916	1,132	1,422	1,614	1,794
84	564	794	973	1,208	1,517	1,728	1,927
96	602	832	1,049	1,284	1,612	1,842	2,060
101	621	851	1,068	1,303	1,650	1,899	2,098

Series 12

Length Up To	Overall Finished Width						
	42	63	84	105	126	147	168
36	430	609	756	940	1,166	1,324	1,472
48	472	672	819	1,024	1,271	1,450	1,619
60	514	714	903	1,108	1,376	1,576	1,766
72	556	777	966	1,192	1,502	1,702	1,892
84	598	840	1,029	1,276	1,607	1,828	2,039
96	640	882	1,113	1,360	1,712	1,954	2,186
101	661	903	1,134	1,381	1,754	2,017	2,228

Series 13

Length Up To	Overall Finished Width						
	42	63	84	105	126	147	168
36	448	633	786	976	1,214	1,376	1,530
48	494	702	855	1,068	1,329	1,514	1,691
60	540	748	947	1,160	1,444	1,652	1,852
72	586	817	1,016	1,252	1,582	1,790	1,990
84	632	886	1,085	1,344	1,697	1,928	2,151
96	678	932	1,177	1,436	1,812	2,066	2,312
101	701	955	1,200	1,459	1,858	2,135	2,358

Series 14

Length Up To	Overall Finished Width						
	42	63	84	105	126	147	168
36	466	657	816	1,012	1,262	1,428	1,588
48	516	732	891	1,112	1,387	1,578	1,763
60	566	782	991	1,212	1,512	1,728	1,938
72	616	857	1,066	1,312	1,662	1,878	2,088
84	666	932	1,141	1,412	1,787	2,028	2,263
96	716	982	1,241	1,512	1,912	2,178	2,438
101	741	1,007	1,266	1,537	1,962	2,253	2,488

Series 15

Length Up To	Overall Finished Width						
	42	63	84	105	126	147	168
36	484	681	846	1,048	1,310	1,480	1,646
48	538	762	927	1,156	1,445	1,642	1,835
60	592	816	1,035	1,264	1,580	1,804	2,024
72	646	897	1,116	1,372	1,742	1,966	2,186
84	700	978	1,197	1,480	1,877	2,128	2,375
96	754	1,032	1,305	1,588	2,012	2,290	2,564
101	781	1,059	1,332	1,615	2,066	2,371	2,618

Series 16

Length Up To	Overall Finished Width						
	42	63	84	105	126	147	168
36	502	705	876	1,084	1,358	1,532	1,704
48	560	792	963	1,200	1,503	1,706	1,907
60	618	850	1,079	1,316	1,648	1,880	2,110
72	676	937	1,166	1,432	1,822	2,054	2,284
84	734	1,024	1,253	1,548	1,967	2,228	2,487
96	792	1,082	1,369	1,664	2,112	2,402	2,690
101	821	1,111	1,398	1,693	2,170	2,489	2,748

GROMMET DRAPERIES: 3 Fullness — Lined (Lining 01000)

Sizes and series numbers beyond what is listed in the charts below are available—please submit these quote requests via fax or email.

Number of Widths						
3	4	5	6	8	9	10

Number of Widths						
3	4	5	6	8	9	10

Series 17

Length Up To	Overall Finished Width						
	42	63	84	105	126	147	168
36	520	729	906	1,120	1,406	1,584	1,762
48	582	822	999	1,244	1,561	1,770	1,979
60	644	884	1,123	1,368	1,716	1,956	2,196
72	706	977	1,216	1,492	1,902	2,142	2,382
84	768	1,070	1,309	1,616	2,057	2,328	2,599
96	830	1,132	1,433	1,740	2,212	2,514	2,816
101	861	1,163	1,464	1,771	2,274	2,607	2,878

Series 18

Length Up To	Overall Finished Width						
	42	63	84	105	126	147	168
36	538	753	936	1,156	1,454	1,636	1,820
48	604	852	1,035	1,288	1,619	1,834	2,051
60	670	918	1,167	1,420	1,784	2,032	2,282
72	736	1,017	1,266	1,552	1,982	2,230	2,480
84	802	1,116	1,365	1,684	2,147	2,428	2,711
96	868	1,182	1,497	1,816	2,312	2,626	2,942
101	901	1,215	1,530	1,849	2,378	2,725	3,008

Series 19

Length Up To	Overall Finished Width						
	42	63	84	105	126	147	168
36	556	777	966	1,192	1,502	1,688	1,878
48	626	882	1,071	1,332	1,677	1,898	2,123
60	696	952	1,211	1,472	1,852	2,108	2,368
72	766	1,057	1,316	1,612	2,062	2,318	2,578
84	836	1,162	1,421	1,752	2,237	2,528	2,823
96	906	1,232	1,561	1,892	2,412	2,738	3,068
101	941	1,267	1,596	1,927	2,482	2,843	3,138

Series 20

Length Up To	Overall Finished Width						
	42	63	84	105	126	147	168
36	574	801	996	1,228	1,550	1,740	1,936
48	648	912	1,107	1,376	1,735	1,962	2,195
60	722	986	1,255	1,524	1,920	2,184	2,454
72	796	1,097	1,366	1,672	2,142	2,406	2,676
84	870	1,208	1,477	1,820	2,327	2,628	2,935
96	944	1,282	1,625	1,968	2,512	2,850	3,194
101	981	1,319	1,662	2,005	2,586	2,961	3,268

Series 21

Length Up To	Overall Finished Width						
	42	63	84	105	126	147	168
36	592	825	1,026	1,264	1,598	1,792	1,994
48	670	942	1,143	1,420	1,793	2,026	2,267
60	748	1,020	1,299	1,576	1,988	2,260	2,540
72	826	1,137	1,416	1,732	2,222	2,494	2,774
84	904	1,254	1,533	1,888	2,417	2,728	3,047
96	982	1,332	1,689	2,044	2,612	2,962	3,320
101	1,021	1,371	1,728	2,083	2,690	3,079	3,398

Series 22

Length Up To	Overall Finished Width						
	42	63	84	105	126	147	168
36	610	849	1,056	1,300	1,646	1,844	2,052
48	692	972	1,179	1,464	1,851	2,090	2,339
60	774	1,054	1,343	1,628	2,056	2,336	2,626
72	856	1,177	1,466	1,792	2,302	2,582	2,872
84	938	1,300	1,589	1,956	2,507	2,828	3,159
96	1,020	1,382	1,753	2,120	2,712	3,074	3,446
101	1,061	1,423	1,794	2,161	2,794	3,197	3,528

Series 23

Length Up To	Overall Finished Width						
	42	63	84	105	126	147	168
36	628	873	1,086	1,336	1,694	1,896	2,110
48	714	1,002	1,215	1,508	1,909	2,154	2,411
60	800	1,088	1,387	1,680	2,124	2,412	2,712
72	886	1,217	1,516	1,852	2,382	2,670	2,970
84	972	1,346	1,645	2,024	2,597	2,928	3,271
96	1,058	1,432	1,817	2,196	2,812	3,186	3,572
101	1,101	1,475	1,860	2,239	2,898	3,315	3,658

Series 24

Length Up To	Overall Finished Width						
	42	63	84	105	126	147	168
36	646	897	1,116	1,372	1,742	1,948	2,168
48	736	1,032	1,251	1,552	1,967	2,218	2,483
60	826	1,122	1,431	1,732	2,192	2,488	2,798
72	916	1,257	1,566	1,912	2,462	2,758	3,068
84	1,006	1,392	1,701	2,092	2,687	3,028	3,383
96	1,096	1,482	1,881	2,272	2,912	3,298	3,698
101	1,141	1,527	1,926	2,317	3,002	3,433	3,788

Series 25

Length Up To	Overall Finished Width						
	42	63	84	105	126	147	168
36	673	933	1,161	1,426	1,814	2,026	2,255
48	769	1,077	1,305	1,618	2,054	2,314	2,591
60	865	1,173	1,497	1,810	2,294	2,602	2,927
72	961	1,317	1,641	2,002	2,582	2,890	3,215
84	1,057	1,461	1,785	2,194	2,822	3,178	3,551
96	1,153	1,557	1,977	2,386	3,062	3,466	3,887
101	1,201	1,605	2,025	2,434	3,158	3,610	3,983

Series 26

Length Up To	Overall Finished Width						
	42	63	84	105	126	147	168
36	691	957	1,191	1,462	1,862	2,078	2,313
48	791	1,107	1,341	1,662	2,112	2,378	2,663
60	891	1,207	1,541	1,862	2,362	2,678	3,013
72	991	1,357	1,691	2,062	2,662	2,978	3,313
84	1,091	1,507	1,841	2,262	2,912	3,278	3,663
96	1,191	1,607	2,041	2,462	3,162	3,578	4,013
101	1,241	1,657	2,091	2,512	3,262	3,728	4,113

GROMMET DRAPERIES: 4 Fullness — Unlined

Sizes and series numbers beyond what is listed in the charts below are available—please submit these quote requests via fax or email.

Number of Widths						
4	5	7	8	10	12	13

Number of Widths						
4	5	7	8	10	12	13

Series 7							
Length Up To	Overall Finished Width						
	42	63	84	105	126	147	168
36	198	266	347	414	503	602	651
48	230	297	389	467	576	686	746
72	282	371	494	582	713	854	924
84	314	402	536	635	786	938	1,019
108	366	476	641	750	923	1,106	1,197
120	398	507	683	803	996	1,190	1,292
144	450	581	788	918	1,133	1,358	1,470

Series 8							
Length Up To	Overall Finished Width						
	42	63	84	105	126	147	168
36	228	303	399	474	575	689	746
48	267	342	451	539	666	793	863
72	332	433	581	682	835	1,001	1,084
84	371	472	633	747	926	1,105	1,201
108	436	563	763	890	1,095	1,313	1,422
120	475	602	815	955	1,186	1,417	1,539
144	540	693	945	1,098	1,355	1,625	1,760

Series 9							
Length Up To	Overall Finished Width						
	42	63	84	105	126	147	168
36	252	333	441	522	633	759	822
48	297	378	501	597	738	879	957
72	372	483	651	762	933	1,119	1,212
84	417	528	711	837	1,038	1,239	1,347
108	492	633	861	1,002	1,233	1,479	1,602
120	537	678	921	1,077	1,338	1,599	1,737
144	612	783	1,071	1,242	1,533	1,839	1,992

Series 10							
Length Up To	Overall Finished Width						
	42	63	84	105	126	147	168
36	276	363	483	570	691	829	898
48	327	414	551	655	810	965	1,051
72	412	533	721	842	1,031	1,237	1,340
84	463	584	789	927	1,150	1,373	1,493
108	548	703	959	1,114	1,371	1,645	1,782
120	599	754	1,027	1,199	1,490	1,781	1,935
144	684	873	1,197	1,386	1,711	2,053	2,224

Series 11							
Length Up To	Overall Finished Width						
	42	63	84	105	126	147	168
36	300	393	525	618	749	899	974
48	357	450	601	713	882	1,051	1,145
72	452	583	791	922	1,129	1,355	1,468
84	509	640	867	1,017	1,262	1,507	1,639
108	604	773	1,057	1,226	1,509	1,811	1,962
120	661	830	1,133	1,321	1,642	1,963	2,133
144	756	963	1,323	1,530	1,889	2,267	2,456

Series 12							
Length Up To	Overall Finished Width						
	42	63	84	105	126	147	168
36	324	423	567	666	807	969	1,050
48	387	486	651	771	954	1,137	1,239
72	492	633	861	1,002	1,227	1,473	1,596
84	555	696	945	1,107	1,374	1,641	1,785
108	660	843	1,155	1,338	1,647	1,977	2,142
120	723	906	1,239	1,443	1,794	2,145	2,331
144	828	1,053	1,449	1,674	2,067	2,481	2,688

Series 13							
Length Up To	Overall Finished Width						
	42	63	84	105	126	147	168
36	348	453	609	714	865	1,039	1,126
48	417	522	701	829	1,026	1,223	1,333
72	532	683	931	1,082	1,325	1,591	1,724
84	601	752	1,023	1,197	1,486	1,775	1,931
108	716	913	1,253	1,450	1,785	2,143	2,322
120	785	982	1,345	1,565	1,946	2,327	2,529
144	900	1,143	1,575	1,818	2,245	2,695	2,920

Series 14							
Length Up To	Overall Finished Width						
	42	63	84	105	126	147	168
36	372	483	651	762	923	1,109	1,202
48	447	558	751	887	1,098	1,309	1,427
72	572	733	1,001	1,162	1,423	1,709	1,852
84	647	808	1,101	1,287	1,598	1,909	2,077
108	772	983	1,351	1,562	1,923	2,309	2,502
120	847	1,058	1,451	1,687	2,098	2,509	2,727
144	972	1,233	1,701	1,962	2,423	2,909	3,152

Series 15							
Length Up To	Overall Finished Width						
	42	63	84	105	126	147	168
36	396	513	693	810	981	1,179	1,278
48	477	594	801	945	1,170	1,395	1,521
72	612	783	1,071	1,242	1,521	1,827	1,980
84	693	864	1,179	1,377	1,710	2,043	2,223
108	828	1,053	1,449	1,674	2,061	2,475	2,682
120	909	1,134	1,557	1,809	2,250	2,691	2,925
144	1,044	1,323	1,827	2,106	2,601	3,123	3,384

Series 16							
Length Up To	Overall Finished Width						
	42	63	84	105	126	147	168
36	420	543	735	858	1,039	1,249	1,354
48	507	630	851	1,003	1,242	1,481	1,615
72	652	833	1,141	1,322	1,619	1,945	2,108
84	739	920	1,257	1,467	1,822	2,177	2,369
108	884	1,123	1,547	1,786	2,199	2,641	2,862
120	971	1,210	1,663	1,931	2,402	2,873	3,123
144	1,116	1,413	1,953	2,250	2,779	3,337	3,616

GROMMET DRAPERIES: 4 Fullness — Unlined

Sizes and series numbers beyond what is listed in the charts below are available—please submit these quote requests via fax or email.

Number of Widths						
4	5	7	8	10	12	13

Number of Widths						
4	5	7	8	10	12	13

Series 17

Length Up To	Overall Finished Width						
	42	63	84	105	126	147	168
36	444	573	777	906	1,097	1,319	1,430
48	537	666	901	1,061	1,314	1,567	1,709
72	692	883	1,211	1,402	1,717	2,063	2,236
84	785	976	1,335	1,557	1,934	2,311	2,515
108	940	1,193	1,645	1,898	2,337	2,807	3,042
120	1,033	1,286	1,769	2,053	2,554	3,055	3,321
144	1,188	1,503	2,079	2,394	2,957	3,551	3,848

Series 18

Length Up To	Overall Finished Width						
	42	63	84	105	126	147	168
36	468	603	819	954	1,155	1,389	1,506
48	567	702	951	1,119	1,386	1,653	1,803
72	732	933	1,281	1,482	1,815	2,181	2,364
84	831	1,032	1,413	1,647	2,046	2,445	2,661
108	996	1,263	1,743	2,010	2,475	2,973	3,222
120	1,095	1,362	1,875	2,175	2,706	3,237	3,519
144	1,260	1,593	2,205	2,538	3,135	3,765	4,080

Series 19

Length Up To	Overall Finished Width						
	42	63	84	105	126	147	168
36	492	633	861	1,002	1,213	1,459	1,582
48	597	738	1,001	1,177	1,458	1,739	1,897
72	772	983	1,351	1,562	1,913	2,299	2,492
84	877	1,088	1,491	1,737	2,158	2,579	2,807
108	1,052	1,333	1,841	2,122	2,613	3,139	3,402
120	1,157	1,438	1,981	2,297	2,858	3,419	3,717
144	1,332	1,683	2,331	2,682	3,313	3,979	4,312

Series 20

Length Up To	Overall Finished Width						
	42	63	84	105	126	147	168
36	516	663	903	1,050	1,271	1,529	1,658
48	627	774	1,051	1,235	1,530	1,825	1,991
72	812	1,033	1,421	1,642	2,011	2,417	2,620
84	923	1,144	1,569	1,827	2,270	2,713	2,953
108	1,108	1,403	1,939	2,234	2,751	3,305	3,582
120	1,219	1,514	2,087	2,419	3,010	3,601	3,915
144	1,404	1,773	2,457	2,826	3,491	4,193	4,544

Series 21

Length Up To	Overall Finished Width						
	42	63	84	105	126	147	168
36	540	693	945	1,098	1,329	1,599	1,734
48	657	810	1,101	1,293	1,602	1,911	2,085
72	852	1,083	1,491	1,722	2,109	2,535	2,748
84	969	1,200	1,647	1,917	2,382	2,847	3,099
108	1,164	1,473	2,037	2,346	2,889	3,471	3,762
120	1,281	1,590	2,193	2,541	3,162	3,783	4,113
144	1,476	1,863	2,583	2,970	3,669	4,407	4,776

Series 22

Length Up To	Overall Finished Width						
	42	63	84	105	126	147	168
36	564	723	987	1,146	1,387	1,669	1,810
48	687	846	1,151	1,351	1,674	1,997	2,179
72	892	1,133	1,561	1,802	2,207	2,653	2,876
84	1,015	1,256	1,725	2,007	2,494	2,981	3,245
108	1,220	1,543	2,135	2,458	3,027	3,637	3,942
120	1,343	1,666	2,299	2,663	3,314	3,965	4,311
144	1,548	1,953	2,709	3,114	3,847	4,621	5,008

Series 23

Length Up To	Overall Finished Width						
	42	63	84	105	126	147	168
36	588	753	1,029	1,194	1,445	1,739	1,886
48	717	882	1,201	1,409	1,746	2,083	2,273
72	932	1,183	1,631	1,882	2,305	2,771	3,004
84	1,061	1,312	1,803	2,097	2,606	3,115	3,391
108	1,276	1,613	2,233	2,570	3,165	3,803	4,122
120	1,405	1,742	2,405	2,785	3,466	4,147	4,509
144	1,620	2,043	2,835	3,258	4,025	4,835	5,240

Series 24

Length Up To	Overall Finished Width						
	42	63	84	105	126	147	168
36	612	783	1,071	1,242	1,503	1,809	1,962
48	747	918	1,251	1,467	1,818	2,169	2,367
72	972	1,233	1,701	1,962	2,403	2,889	3,132
84	1,107	1,368	1,881	2,187	2,718	3,249	3,537
108	1,332	1,683	2,331	2,682	3,303	3,969	4,302
120	1,467	1,818	2,511	2,907	3,618	4,329	4,707
144	1,692	2,133	2,961	3,402	4,203	5,049	5,472

Series 25

Length Up To	Overall Finished Width						
	42	63	84	105	126	147	168
36	648	828	1,134	1,314	1,590	1,914	2,076
48	792	972	1,326	1,554	1,926	2,298	2,508
72	1,032	1,308	1,806	2,082	2,550	3,066	3,324
84	1,176	1,452	1,998	2,322	2,886	3,450	3,756
108	1,416	1,788	2,478	2,850	3,510	4,218	4,572
120	1,560	1,932	2,670	3,090	3,846	4,602	5,004
144	1,800	2,268	3,150	3,618	4,470	5,370	5,820

Series 26

Length Up To	Overall Finished Width						
	42	63	84	105	126	147	168
36	672	858	1,176	1,362	1,648	1,984	2,152
48	822	1,008	1,376	1,612	1,998	2,384	2,602
72	1,072	1,358	1,876	2,162	2,648	3,184	3,452
84	1,222	1,508	2,076	2,412	2,998	3,584	3,902
108	1,472	1,858	2,576	2,962	3,648	4,384	4,752
120	1,622	2,008	2,776	3,212	3,998	4,784	5,202
144	1,872	2,358	3,276	3,762	4,648	5,584	6,052

GROMMET DRAPERIES: 4 Fullness — Lined (Lining 01000)

Sizes and series numbers beyond what is listed in the charts below are available—please submit these quote requests via fax or email.

Number of Widths						
4	5	7	8	10	12	13

Number of Widths						
4	5	7	8	10	12	13

Series 7							
Length Up To	Overall Finished Width						
	42	63	84	105	126	147	168
36	426	582	768	940	1,117	1,320	1,475
48	457	614	810	992	1,190	1,404	1,569
60	478	656	863	1,045	1,264	1,488	1,653
72	510	687	915	1,108	1,327	1,572	1,748
84	541	719	957	1,160	1,400	1,656	1,842
96	562	761	1,010	1,213	1,474	1,740	1,926
101	573	771	1,031	1,234	1,495	1,771	1,968

Series 8							
Length Up To	Overall Finished Width						
	42	63	84	105	126	147	168
36	456	620	821	1,000	1,189	1,407	1,570
48	495	659	873	1,065	1,280	1,511	1,687
60	521	711	938	1,130	1,371	1,615	1,791
72	560	750	1,003	1,208	1,449	1,719	1,908
84	599	789	1,055	1,273	1,540	1,823	2,025
96	625	841	1,120	1,338	1,631	1,927	2,129
101	638	854	1,146	1,364	1,657	1,966	2,181

Series 9							
Length Up To	Overall Finished Width						
	42	63	84	105	126	147	168
36	480	650	863	1,048	1,247	1,477	1,646
48	525	695	923	1,123	1,352	1,597	1,781
60	555	755	998	1,198	1,457	1,717	1,901
72	600	800	1,073	1,288	1,547	1,837	2,036
84	645	845	1,133	1,363	1,652	1,957	2,171
96	675	905	1,208	1,438	1,757	2,077	2,291
101	690	920	1,238	1,468	1,787	2,122	2,351

Series 10							
Length Up To	Overall Finished Width						
	42	63	84	105	126	147	168
36	504	680	905	1,096	1,305	1,547	1,722
48	555	731	973	1,181	1,424	1,683	1,875
60	589	799	1,058	1,266	1,543	1,819	2,011
72	640	850	1,143	1,368	1,645	1,955	2,164
84	691	901	1,211	1,453	1,764	2,091	2,317
96	725	969	1,296	1,538	1,883	2,227	2,453
101	742	986	1,330	1,572	1,917	2,278	2,521

Series 11							
Length Up To	Overall Finished Width						
	42	63	84	105	126	147	168
36	528	710	947	1,144	1,363	1,617	1,798
48	585	767	1,023	1,239	1,496	1,769	1,969
60	623	843	1,118	1,334	1,629	1,921	2,121
72	680	900	1,213	1,448	1,743	2,073	2,292
84	737	957	1,289	1,543	1,876	2,225	2,463
96	775	1,033	1,384	1,638	2,009	2,377	2,615
101	794	1,052	1,422	1,676	2,047	2,434	2,691

Series 12							
Length Up To	Overall Finished Width						
	42	63	84	105	126	147	168
36	552	740	989	1,192	1,421	1,687	1,874
48	615	803	1,073	1,297	1,568	1,855	2,063
60	657	887	1,178	1,402	1,715	2,023	2,231
72	720	950	1,283	1,528	1,841	2,191	2,420
84	783	1,013	1,367	1,633	1,988	2,359	2,609
96	825	1,097	1,472	1,738	2,135	2,527	2,777
101	846	1,118	1,514	1,780	2,177	2,590	2,861

Series 13							
Length Up To	Overall Finished Width						
	42	63	84	105	126	147	168
36	576	770	1,031	1,240	1,479	1,757	1,950
48	645	839	1,123	1,355	1,640	1,941	2,157
60	691	931	1,238	1,470	1,801	2,125	2,341
72	760	1,000	1,353	1,608	1,939	2,309	2,548
84	829	1,069	1,445	1,723	2,100	2,493	2,755
96	875	1,161	1,560	1,838	2,261	2,677	2,939
101	898	1,184	1,606	1,884	2,307	2,746	3,031

Series 14							
Length Up To	Overall Finished Width						
	42	63	84	105	126	147	168
36	600	800	1,073	1,288	1,537	1,827	2,026
48	675	875	1,173	1,413	1,712	2,027	2,251
60	725	975	1,298	1,538	1,887	2,227	2,451
72	800	1,050	1,423	1,688	2,037	2,427	2,676
84	875	1,125	1,523	1,813	2,212	2,627	2,901
96	925	1,225	1,648	1,938	2,387	2,827	3,101
101	950	1,250	1,698	1,988	2,437	2,902	3,201

Series 15							
Length Up To	Overall Finished Width						
	42	63	84	105	126	147	168
36	624	830	1,115	1,336	1,595	1,897	2,102
48	705	911	1,223	1,471	1,784	2,113	2,345
60	759	1,019	1,358	1,606	1,973	2,329	2,561
72	840	1,100	1,493	1,768	2,135	2,545	2,804
84	921	1,181	1,601	1,903	2,324	2,761	3,047
96	975	1,289	1,736	2,038	2,513	2,977	3,263
101	1,002	1,316	1,790	2,092	2,567	3,058	3,371

Series 16							
Length Up To	Overall Finished Width						
	42	63	84	105	126	147	168
36	648	860	1,157	1,384	1,653	1,967	2,178
48	735	947	1,273	1,529	1,856	2,199	2,439
60	793	1,063	1,418	1,674	2,059	2,431	2,671
72	880	1,150	1,563	1,848	2,233	2,663	2,932
84	967	1,237	1,679	1,993	2,436	2,895	3,193
96	1,025	1,353	1,824	2,138	2,639	3,127	3,425
101	1,054	1,382	1,882	2,196	2,697	3,214	3,541

GROMMET DRAPERIES: 4 Fullness — Lined (Lining 01000)

Sizes and series numbers beyond what is listed in the charts below are available—please submit these quote requests via fax or email.

Number of Widths						
4	5	7	8	10	12	13

Number of Widths						
4	5	7	8	10	12	13

Series 17

Length Up To	Overall Finished Width						
	42	63	84	105	126	147	168
36	672	890	1,199	1,432	1,711	2,037	2,254
48	765	983	1,323	1,587	1,928	2,285	2,533
60	827	1,107	1,478	1,742	2,145	2,533	2,781
72	920	1,200	1,633	1,928	2,331	2,781	3,060
84	1,013	1,293	1,757	2,083	2,548	3,029	3,339
96	1,075	1,417	1,912	2,238	2,765	3,277	3,587
101	1,106	1,448	1,974	2,300	2,827	3,370	3,711

Series 18

Length Up To	Overall Finished Width						
	42	63	84	105	126	147	168
36	696	920	1,241	1,480	1,769	2,107	2,330
48	795	1,019	1,373	1,645	2,000	2,371	2,627
60	861	1,151	1,538	1,810	2,231	2,635	2,891
72	960	1,250	1,703	2,008	2,429	2,899	3,188
84	1,059	1,349	1,835	2,173	2,660	3,163	3,485
96	1,125	1,481	2,000	2,338	2,891	3,427	3,749
101	1,158	1,514	2,066	2,404	2,957	3,526	3,881

Series 19

Length Up To	Overall Finished Width						
	42	63	84	105	126	147	168
36	720	950	1,283	1,528	1,827	2,177	2,406
48	825	1,055	1,423	1,703	2,072	2,457	2,721
60	895	1,195	1,598	1,878	2,317	2,737	3,001
72	1,000	1,300	1,773	2,088	2,527	3,017	3,316
84	1,105	1,405	1,913	2,263	2,772	3,297	3,631
96	1,175	1,545	2,088	2,438	3,017	3,577	3,911
101	1,210	1,580	2,158	2,508	3,087	3,682	4,051

Series 20

Length Up To	Overall Finished Width						
	42	63	84	105	126	147	168
36	744	980	1,325	1,576	1,885	2,247	2,482
48	855	1,091	1,473	1,761	2,144	2,543	2,815
60	929	1,239	1,658	1,946	2,403	2,839	3,111
72	1,040	1,350	1,843	2,168	2,625	3,135	3,444
84	1,151	1,461	1,991	2,353	2,884	3,431	3,777
96	1,225	1,609	2,176	2,538	3,143	3,727	4,073
101	1,262	1,646	2,250	2,612	3,217	3,838	4,221

Series 21

Length Up To	Overall Finished Width						
	42	63	84	105	126	147	168
36	768	1,010	1,367	1,624	1,943	2,317	2,558
48	885	1,127	1,523	1,819	2,216	2,629	2,909
60	963	1,283	1,718	2,014	2,489	2,941	3,221
72	1,080	1,400	1,913	2,248	2,723	3,253	3,572
84	1,197	1,517	2,069	2,443	2,996	3,565	3,923
96	1,275	1,673	2,264	2,638	3,269	3,877	4,235
101	1,314	1,712	2,342	2,716	3,347	3,994	4,391

Series 22

Length Up To	Overall Finished Width						
	42	63	84	105	126	147	168
36	792	1,040	1,409	1,672	2,001	2,387	2,634
48	915	1,163	1,573	1,877	2,288	2,715	3,003
60	997	1,327	1,778	2,082	2,575	3,043	3,331
72	1,120	1,450	1,983	2,328	2,821	3,371	3,700
84	1,243	1,573	2,147	2,533	3,108	3,699	4,069
96	1,325	1,737	2,352	2,738	3,395	4,027	4,397
101	1,366	1,778	2,434	2,820	3,477	4,150	4,561

Series 23

Length Up To	Overall Finished Width						
	42	63	84	105	126	147	168
36	816	1,070	1,451	1,720	2,059	2,457	2,710
48	945	1,199	1,623	1,935	2,360	2,801	3,097
60	1,031	1,371	1,838	2,150	2,661	3,145	3,441
72	1,160	1,500	2,053	2,408	2,919	3,489	3,828
84	1,289	1,629	2,225	2,623	3,220	3,833	4,215
96	1,375	1,801	2,440	2,838	3,521	4,177	4,559
101	1,418	1,844	2,526	2,924	3,607	4,306	4,731

Series 24

Length Up To	Overall Finished Width						
	42	63	84	105	126	147	168
36	840	1,100	1,493	1,768	2,117	2,527	2,786
48	975	1,235	1,673	1,993	2,432	2,887	3,191
60	1,065	1,415	1,898	2,218	2,747	3,247	3,551
72	1,200	1,550	2,123	2,488	3,017	3,607	3,956
84	1,335	1,685	2,303	2,713	3,332	3,967	4,361
96	1,425	1,865	2,528	2,938	3,647	4,327	4,721
101	1,470	1,910	2,618	3,028	3,737	4,462	4,901

Series 25

Length Up To	Overall Finished Width						
	42	63	84	105	126	147	168
36	876	1,145	1,556	1,840	2,204	2,632	2,900
48	1,020	1,289	1,748	2,080	2,540	3,016	3,332
60	1,116	1,481	1,988	2,320	2,876	3,400	3,716
72	1,260	1,625	2,228	2,608	3,164	3,784	4,148
84	1,404	1,769	2,420	2,848	3,500	4,168	4,580
96	1,500	1,961	2,660	3,088	3,836	4,552	4,964
101	1,548	2,009	2,756	3,184	3,932	4,696	5,156

Series 26

Length Up To	Overall Finished Width						
	42	63	84	105	126	147	168
36	900	1,175	1,598	1,888	2,262	2,702	2,976
48	1,050	1,325	1,798	2,138	2,612	3,102	3,426
60	1,150	1,525	2,048	2,388	2,962	3,502	3,826
72	1,300	1,675	2,298	2,688	3,262	3,902	4,276
84	1,450	1,825	2,498	2,938	3,612	4,302	4,726
96	1,550	2,025	2,748	3,188	3,962	4,702	5,126
101	1,600	2,075	2,848	3,288	4,062	4,852	5,326

RING TOP DRAPERIES: 2 Fullness — Unlined

Sizes and series numbers beyond what is listed in the charts below are available—please submit these quote requests via fax or email.

Number of Widths						
2	3	4	4	5	6	7

Number of Widths						
2	3	4	4	5	6	7

Series 7							
Length Up To	Overall Finished Width						
	42	63	84	105	126	147	168
36	133	194	241	270	332	393	439
48	154	215	272	302	374	435	491
72	175	257	325	354	437	519	586
84	196	278	356	386	479	561	638
108	217	320	409	438	542	645	733
120	238	341	440	470	584	687	785
144	259	383	493	522	647	771	880

Series 8							
Length Up To	Overall Finished Width						
	42	63	84	105	126	147	168
36	151	219	273	303	372	440	494
48	177	245	312	342	424	492	559
72	203	297	377	407	502	596	676
84	229	323	416	446	554	648	741
108	255	375	481	511	632	752	858
120	281	401	520	550	684	804	923
144	307	453	585	615	762	908	1,040

Series 9							
Length Up To	Overall Finished Width						
	42	63	84	105	126	147	168
36	165	239	299	329	404	478	538
48	195	269	344	374	464	538	613
72	225	329	419	449	554	658	748
84	255	359	464	494	614	718	823
108	285	419	539	569	704	838	958
120	315	449	584	614	764	898	1,033
144	345	509	659	689	854	1,018	1,168

Series 10							
Length Up To	Overall Finished Width						
	42	63	84	105	126	147	168
36	179	259	325	355	436	516	582
48	213	293	376	406	504	584	667
72	247	361	461	491	606	720	820
84	281	395	512	542	674	788	905
108	315	463	597	627	776	924	1,058
120	349	497	648	678	844	992	1,143
144	383	565	733	763	946	1,128	1,296

Series 11							
Length Up To	Overall Finished Width						
	42	63	84	105	126	147	168
36	193	279	351	381	468	554	626
48	231	317	408	438	544	630	721
72	269	393	503	533	658	782	892
84	307	431	560	590	886	858	987
108	345	545	655	685	848	1,010	1,158
120	383	545	712	742	924	1,086	1,253
144	421	621	807	837	1,038	1,238	1,424

Series 12							
Length Up To	Overall Finished Width						
	42	63	84	105	126	147	168
36	207	299	377	407	500	592	670
48	249	341	440	470	584	676	775
72	291	425	545	575	710	844	964
84	333	467	608	638	794	928	1,069
108	375	551	713	743	920	1,096	1,258
120	417	593	776	806	1,004	1,180	1,363
144	459	677	881	911	1,130	1,348	1,552

Series 13							
Length Up To	Overall Finished Width						
	42	63	84	105	126	147	168
36	221	319	403	433	532	630	714
48	267	365	472	502	624	722	829
72	313	457	587	617	762	906	1,036
84	359	503	656	686	854	998	1,151
108	405	595	771	801	992	1,182	1,358
120	451	641	840	870	1,084	1,274	1,473
144	497	733	955	985	1,222	1,458	1,680

Series 14							
Length Up To	Overall Finished Width						
	42	63	84	105	126	147	168
36	235	339	429	459	564	668	758
48	285	389	504	534	664	768	883
72	335	489	629	659	814	968	1,108
84	385	539	704	734	914	1,068	1,233
108	435	639	829	859	1,064	1,268	1,458
120	485	689	904	934	1,164	1,368	1,583
144	535	789	1,029	1,059	1,314	1,568	1,808

Series 15							
Length Up To	Overall Finished Width						
	42	63	84	105	126	147	168
36	249	359	455	485	596	706	802
48	303	413	536	566	704	814	937
72	357	521	671	701	866	1,030	1,180
84	411	575	752	782	974	1,138	1,315
108	465	683	887	917	1,136	1,354	1,558
120	519	737	968	998	1,244	1,462	1,693
144	573	845	1,103	1,133	1,406	1,678	1,936

Series 16							
Length Up To	Overall Finished Width						
	42	63	84	105	126	147	168
36	263	379	481	511	628	744	846
48	321	437	568	598	744	860	991
72	379	553	713	743	918	1,092	1,252
84	437	611	800	830	1,034	1,208	1,397
108	495	727	945	975	1,208	1,440	1,658
120	553	785	1,032	1,062	1,324	1,556	1,803
144	611	901	1,177	1,207	1,498	1,788	2,064

RING TOP DRAPERIES: 2 Fullness — Unlined

Sizes and series numbers beyond what is listed in the charts below are available—please submit these quote requests via fax or email.

Number of Widths						
2	3	4	4	5	6	7

Number of Widths						
2	3	4	4	5	6	7

Series 17

Length Up To	Overall Finished Width						
	42	63	84	105	126	147	168
36	277	399	507	537	660	782	890
48	339	461	600	630	784	906	1,045
72	401	585	755	785	970	1,154	1,324
84	463	647	848	878	1,094	1,278	1,479
108	525	771	1,003	1,033	1,280	1,526	1,758
120	587	833	1,096	1,126	1,404	1,650	1,913
144	649	957	1,251	1,281	1,590	1,898	2,192

Series 18

Length Up To	Overall Finished Width						
	42	63	84	105	126	147	168
36	291	419	533	563	692	820	934
48	357	485	632	662	824	952	1,099
72	423	617	797	827	1,022	1,216	1,396
84	489	683	896	926	1,154	1,348	1,561
108	555	815	1,061	1,091	1,352	1,612	1,858
120	621	881	1,160	1,190	1,484	1,744	2,023
144	687	1,013	1,325	1,355	1,682	2,008	2,320

Series 19

Length Up To	Overall Finished Width						
	42	63	84	105	126	147	168
36	305	439	559	589	724	858	978
48	375	509	664	694	864	998	1,153
72	445	649	839	869	1,074	1,278	1,468
84	515	719	944	974	1,214	1,418	1,643
108	585	859	1,119	1,149	1,424	1,698	1,958
120	655	929	1,224	1,254	1,564	1,838	2,133
144	725	1,069	1,399	1,429	1,774	2,118	2,448

Series 20

Length Up To	Overall Finished Width						
	42	63	84	105	126	147	168
36	319	459	585	615	756	896	1,022
48	393	533	696	726	904	1,044	1,207
72	467	681	881	911	1,126	1,340	1,540
84	541	755	992	1,022	1,274	1,488	1,725
108	615	903	1,177	1,207	1,496	1,784	2,058
120	689	977	1,288	1,318	1,644	1,932	2,243
144	763	1,125	1,473	1,503	1,866	2,228	2,576

Series 21

Length Up To	Overall Finished Width						
	42	63	84	105	126	147	168
36	333	479	611	641	788	934	1,066
48	411	557	728	758	944	1,090	1,261
72	489	713	923	953	1,178	1,402	1,612
84	567	791	1,040	1,070	1,334	1,558	1,807
108	645	947	1,235	1,265	1,568	1,870	2,158
120	723	1,025	1,352	1,382	1,724	2,026	2,353
144	801	1,181	1,547	1,577	1,958	2,338	2,704

Series 22

Length Up To	Overall Finished Width						
	42	63	84	105	126	147	168
36	347	499	637	667	820	972	1,110
48	429	581	760	790	984	1,136	1,315
72	511	745	965	995	1,230	1,464	1,684
84	593	827	1,088	1,118	1,394	1,628	1,889
108	675	991	1,293	1,323	1,640	1,956	2,258
120	757	1,073	1,416	1,446	1,804	2,120	2,463
144	839	1,237	1,621	1,651	2,050	2,448	2,832

Series 23

Length Up To	Overall Finished Width						
	42	63	84	105	126	147	168
36	361	519	663	693	852	1,010	1,154
48	447	605	792	822	1,024	1,182	1,369
72	533	777	1,007	1,037	1,282	1,526	1,756
84	619	863	1,136	1,166	1,454	1,698	1,971
108	705	1,035	1,351	1,381	1,712	2,042	2,358
120	791	1,121	1,480	1,510	1,884	2,214	2,573
144	877	1,293	1,695	1,725	2,142	2,558	2,960

Series 24

Length Up To	Overall Finished Width						
	42	63	84	105	126	147	168
36	375	539	689	719	884	1,048	1,198
48	465	629	824	854	1,064	1,228	1,423
72	555	809	1,049	1,079	1,334	1,588	1,828
84	645	899	1,184	1,214	1,514	1,768	2,053
108	735	1,079	1,409	1,439	1,784	2,128	2,458
120	825	1,169	1,544	1,574	1,964	2,308	2,683
144	915	1,349	1,769	1,799	2,234	2,668	3,088

Series 25

Length Up To	Overall Finished Width						
	42	63	84	105	126	147	168
36	396	569	728	758	932	1,105	1,264
48	492	665	872	902	1,124	1,297	1,504
72	588	857	1,112	1,142	1,412	1,681	1,936
84	684	953	1,256	1,286	1,604	1,873	2,176
108	780	1,145	1,496	1,526	1,892	2,257	2,608
120	876	1,241	1,640	1,670	2,084	2,449	2,848
144	972	1,433	1,880	1,910	2,372	2,833	3,280

Series 26

Length Up To	Overall Finished Width						
	42	63	84	105	126	147	168
36	410	589	754	784	964	1,143	1,308
48	510	689	904	934	1,164	1,343	1,558
72	610	889	1,154	1,184	1,464	1,743	2,008
84	710	989	1,304	1,334	1,664	1,943	2,258
108	810	1,189	1,554	1,584	1,964	2,343	2,708
120	910	1,289	1,704	1,734	2,164	2,543	2,958
144	1,010	1,489	1,954	1,984	2,464	2,943	3,408

RING TOP DRAPERIES: 2 Fullness — Lined (Lining 01000)

Sizes and series numbers beyond what is listed in the charts below are available—please submit these quote requests via fax or email.

Number of Widths						
2	3	4	4	5	6	7

Number of Widths						
2	3	4	4	5	6	7

Series 7							
Length Up To	Overall Finished Width						
	42	63	84	105	126	147	168
36	231	326	419	483	578	688	766
48	252	347	451	514	620	730	818
60	262	368	482	546	651	772	871
72	273	389	503	567	683	814	913
84	294	410	535	598	725	856	965
96	304	431	566	630	756	898	1,018
101	315	441	577	640	767	919	1,028

Series 8							
Length Up To	Overall Finished Width						
	42	63	84	105	126	147	168
36	248	351	452	515	618	735	821
48	274	377	491	554	670	787	886
60	287	403	530	593	709	839	951
72	300	429	556	619	748	891	1,003
84	326	455	595	658	800	943	1,068
96	339	481	634	697	839	995	1,133
101	352	494	647	710	852	1,021	1,146

Series 9							
Length Up To	Overall Finished Width						
	42	63	84	105	126	147	168
36	262	371	478	541	650	773	865
48	292	401	523	586	710	833	940
60	307	431	568	631	755	893	1,015
72	322	461	598	661	800	953	1,075
84	352	491	643	706	860	1,013	1,150
96	367	521	688	751	905	1,073	1,225
101	382	536	703	766	920	1,103	1,240

Series 10							
Length Up To	Overall Finished Width						
	42	63	84	105	126	147	168
36	276	391	504	567	682	811	909
48	310	425	555	618	750	879	994
60	327	459	606	669	801	947	1,079
72	344	493	640	703	852	1,015	1,147
84	378	527	691	754	920	1,083	1,232
96	395	561	742	805	971	1,151	1,317
101	412	578	759	822	988	1,185	1,334

Series 11							
Length Up To	Overall Finished Width						
	42	63	84	105	126	147	168
36	290	411	530	593	714	849	953
48	328	449	587	650	790	925	1,048
60	347	487	644	707	847	1,001	1,143
72	366	525	682	745	904	1,077	1,219
84	404	563	739	802	980	1,153	1,314
96	423	601	796	859	1,037	1,229	1,409
101	442	620	815	878	1,056	1,267	1,428

Series 12							
Length Up To	Overall Finished Width						
	42	63	84	105	126	147	168
36	304	431	556	619	746	887	997
48	346	473	619	682	830	971	1,102
60	367	515	682	745	893	1,055	1,207
72	388	557	724	787	956	1,139	1,291
84	430	599	787	850	1,040	1,223	1,396
96	451	641	850	913	1,103	1,307	1,501
101	472	662	871	934	1,124	1,349	1,522

Series 13							
Length Up To	Overall Finished Width						
	42	63	84	105	126	147	168
36	318	451	582	645	778	925	1,041
48	364	497	651	714	870	1,017	1,156
60	387	543	720	783	939	1,109	1,271
72	410	589	766	829	1,008	1,201	1,363
84	456	635	835	898	1,100	1,293	1,478
96	479	681	904	967	1,169	1,385	1,593
101	502	704	927	990	1,192	1,431	1,616

Series 14							
Length Up To	Overall Finished Width						
	42	63	84	105	126	147	168
36	332	471	608	671	810	963	1,085
48	382	521	683	746	910	1,063	1,210
60	407	571	758	821	985	1,163	1,335
72	432	621	808	871	1,060	1,263	1,435
84	482	671	883	946	1,160	1,363	1,560
96	507	721	958	1,021	1,235	1,463	1,685
101	532	746	983	1,046	1,260	1,513	1,710

Series 15							
Length Up To	Overall Finished Width						
	42	63	84	105	126	147	168
36	346	491	634	697	842	1,001	1,129
48	400	545	715	778	950	1,109	1,264
60	427	599	796	859	1,031	1,217	1,399
72	454	653	850	913	1,112	1,325	1,507
84	508	707	931	994	1,220	1,433	1,642
96	535	761	1,012	1,075	1,301	1,541	1,777
101	562	788	1,039	1,102	1,328	1,595	1,804

Series 16							
Length Up To	Overall Finished Width						
	42	63	84	105	126	147	168
36	360	511	660	723	874	1,039	1,173
48	418	569	747	810	990	1,155	1,318
60	447	627	834	897	1,077	1,271	1,463
72	476	685	892	955	1,164	1,387	1,579
84	534	743	979	1,042	1,280	1,503	1,724
96	563	801	1,066	1,129	1,367	1,619	1,869
101	592	830	1,095	1,158	1,396	1,677	1,898

RING TOP DRAPERIES: 2 Fullness — Lined (Lining 01000)

Sizes and series numbers beyond what is listed in the charts below are available—please submit these quote requests via fax or email.

Number of Widths						
2	3	4	4	5	6	7

Number of Widths						
2	3	4	4	5	6	7

Series 17

Length Up To	Overall Finished Width						
	42	63	84	105	126	147	168
36	374	531	686	749	906	1,077	1,217
48	436	593	779	842	1,030	1,201	1,372
60	467	655	872	935	1,123	1,325	1,527
72	498	717	934	997	1,216	1,449	1,651
84	560	779	1,027	1,090	1,340	1,573	1,806
96	591	841	1,120	1,183	1,433	1,697	1,961
101	622	872	1,151	1,214	1,464	1,759	1,992

Series 18

Length Up To	Overall Finished Width						
	42	63	84	105	126	147	168
36	388	551	712	775	938	1,115	1,261
48	454	617	811	874	1,070	1,247	1,426
60	487	683	910	973	1,169	1,379	1,591
72	520	749	976	1,039	1,268	1,511	1,723
84	586	815	1,075	1,138	1,400	1,643	1,888
96	619	881	1,174	1,237	1,499	1,775	2,053
101	652	914	1,207	1,270	1,532	1,841	2,086

Series 19

Length Up To	Overall Finished Width						
	42	63	84	105	126	147	168
36	402	571	738	801	970	1,153	1,305
48	472	641	843	906	1,110	1,293	1,480
60	507	711	948	1,011	1,215	1,433	1,655
72	542	781	1,018	1,081	1,320	1,573	1,795
84	612	851	1,123	1,186	1,460	1,713	1,970
96	647	921	1,228	1,291	1,565	1,853	2,145
101	682	956	1,263	1,326	1,600	1,923	2,180

Series 20

Length Up To	Overall Finished Width						
	42	63	84	105	126	147	168
36	416	591	764	827	1,002	1,191	1,349
48	490	665	875	938	1,150	1,339	1,534
60	527	739	986	1,049	1,261	1,487	1,719
72	564	813	1,060	1,123	1,372	1,635	1,867
84	638	887	1,171	1,234	1,520	1,783	2,052
96	675	961	1,282	1,345	1,631	1,931	2,237
101	712	998	1,319	1,382	1,668	2,005	2,274

Series 21

Length Up To	Overall Finished Width						
	42	63	84	105	126	147	168
36	430	611	790	853	1,034	1,229	1,393
48	508	689	907	970	1,190	1,385	1,588
60	547	767	1,024	1,087	1,307	1,541	1,783
72	586	845	1,102	1,165	1,424	1,697	1,939
84	664	923	1,219	1,282	1,580	1,853	2,134
96	703	1,001	1,336	1,399	1,697	2,009	2,329
101	742	1,040	1,375	1,438	1,736	2,087	2,368

Series 22

Length Up To	Overall Finished Width						
	42	63	84	105	126	147	168
36	444	631	816	879	1,066	1,267	1,437
48	526	713	939	1,002	1,230	1,431	1,642
60	567	795	1,062	1,125	1,353	1,595	1,847
72	608	877	1,144	1,207	1,476	1,759	2,011
84	690	959	1,267	1,330	1,640	1,923	2,216
96	731	1,041	1,390	1,453	1,763	2,087	2,421
101	772	1,082	1,431	1,494	1,804	2,169	2,462

Series 23

Length Up To	Overall Finished Width						
	42	63	84	105	126	147	168
36	458	651	842	905	1,098	1,305	1,481
48	544	737	971	1,034	1,270	1,477	1,696
60	587	823	1,100	1,163	1,399	1,649	1,911
72	630	909	1,186	1,249	1,528	1,821	2,083
84	716	995	1,315	1,378	1,700	1,993	2,298
96	759	1,081	1,444	1,507	1,829	2,165	2,513
101	802	1,124	1,487	1,550	1,872	2,251	2,556

Series 24

Length Up To	Overall Finished Width						
	42	63	84	105	126	147	168
36	472	671	868	931	1,130	1,343	1,525
48	562	761	1,003	1,066	1,310	1,523	1,750
60	607	851	1,138	1,201	1,445	1,703	1,975
72	652	941	1,228	1,291	1,580	1,883	2,155
84	742	1,031	1,363	1,426	1,760	2,063	2,380
96	787	1,121	1,498	1,561	1,895	2,243	2,605
101	832	1,166	1,543	1,606	1,940	2,333	2,650

Series 25

Length Up To	Overall Finished Width						
	42	63	84	105	126	147	168
36	493	701	907	970	1,178	1,400	1,591
48	589	797	1,051	1,114	1,370	1,592	1,831
60	637	893	1,195	1,258	1,514	1,784	2,071
72	685	989	1,291	1,354	1,658	1,976	2,263
84	781	1,085	1,435	1,498	1,850	2,168	2,503
96	829	1,181	1,579	1,642	1,994	2,360	2,743
101	877	1,229	1,627	1,690	2,042	2,456	2,791

Series 26

Length Up To	Overall Finished Width						
	42	63	84	105	126	147	168
36	507	721	933	996	1,210	1,438	1,635
48	607	821	1,083	1,146	1,410	1,638	1,885
60	657	921	1,233	1,296	1,560	1,838	2,135
72	707	1,021	1,333	1,396	1,710	2,038	2,335
84	807	1,121	1,483	1,546	1,910	2,238	2,585
96	857	1,221	1,633	1,696	2,060	2,438	2,835
101	907	1,271	1,683	1,746	2,110	2,538	2,885

RING TOP DRAPERIES: 2.5 Fullness — Unlined

Sizes and series numbers beyond what is listed in the charts below are available—please submit these quote requests via fax or email.

Number of Widths							
2	3	4	5	6	7	8	

Number of Widths							
2	3	4	5	6	7	8	

Series 7								
Length Up To	Overall Finished Width							
42	63	84	105	126	147	168		
36	133	194	241	302	363	424	470	
48	154	215	272	344	405	477	523	
72	175	257	325	407	489	571	638	
84	196	278	356	449	531	624	691	
108	217	320	409	512	615	718	806	
120	238	341	440	554	657	771	859	
144	259	383	493	617	741	865	974	

Series 8								
Length Up To	Overall Finished Width							
42	63	84	105	126	147	168		
36	151	219	273	342	411	479	533	
48	177	245	312	394	463	544	598	
72	203	297	377	472	567	661	741	
84	229	323	416	524	619	726	806	
108	255	375	481	602	723	843	949	
120	281	401	520	654	775	908	1,014	
144	307	453	585	732	879	1,025	1,157	

Series 9								
Length Up To	Overall Finished Width							
42	63	84	105	126	147	168		
36	165	239	299	374	449	523	583	
48	195	269	344	434	509	598	658	
72	225	329	419	524	629	733	823	
84	255	359	464	584	689	808	898	
108	285	419	539	674	809	943	1,063	
120	315	449	584	734	869	1,018	1,138	
144	345	509	659	824	989	1,153	1,303	

Series 10								
Length Up To	Overall Finished Width							
42	63	84	105	126	147	168		
36	179	259	325	406	487	567	633	
48	213	293	376	474	555	652	718	
72	247	361	461	576	691	805	905	
84	281	395	512	644	759	890	990	
108	315	463	597	746	895	1,043	1,177	
120	349	497	648	814	963	1,128	1,262	
144	383	565	733	916	1,099	1,281	1,449	

Series 11								
Length Up To	Overall Finished Width							
42	63	84	105	126	147	168		
36	193	279	351	438	525	611	683	
48	231	317	408	514	601	706	778	
72	269	393	503	628	753	877	987	
84	307	431	560	704	886	972	1,082	
108	345	545	655	818	981	1,143	1,291	
120	383	545	712	894	1,057	1,238	1,386	
144	421	621	807	1,008	1,209	1,409	1,595	

Series 12								
Length Up To	Overall Finished Width							
42	63	84	105	126	147	168		
36	207	299	377	470	563	655	733	
48	249	341	440	554	647	760	838	
72	291	425	545	680	815	949	1,069	
84	333	467	608	764	899	1,054	1,174	
108	375	551	713	890	1,067	1,243	1,405	
120	417	593	776	974	1,151	1,348	1,510	
144	459	677	881	1,100	1,319	1,537	1,741	

Series 13								
Length Up To	Overall Finished Width							
42	63	84	105	126	147	168		
36	221	319	403	502	601	699	783	
48	267	365	472	594	693	814	898	
72	313	457	587	732	877	1,021	1,151	
84	359	503	656	824	969	1,136	1,266	
108	405	595	771	962	1,153	1,343	1,519	
120	451	641	840	1,054	1,245	1,458	1,634	
144	497	733	955	1,192	1,429	1,665	1,887	

Series 14								
Length Up To	Overall Finished Width							
42	63	84	105	126	147	168		
36	235	339	429	534	639	743	833	
48	285	389	504	634	739	868	958	
72	335	489	629	784	939	1,093	1,233	
84	385	539	704	884	1,039	1,218	1,358	
108	435	639	829	1,034	1,239	1,443	1,633	
120	485	689	904	1,134	1,339	1,568	1,758	
144	535	789	1,029	1,284	1,539	1,793	2,033	

Series 15								
Length Up To	Overall Finished Width							
42	63	84	105	126	147	168		
36	249	359	455	566	677	787	883	
48	303	413	536	674	785	922	1,018	
72	357	521	671	836	1,001	1,165	1,315	
84	411	575	752	944	1,109	1,300	1,450	
108	465	683	887	1,106	1,325	1,543	1,747	
120	519	737	968	1,214	1,433	1,678	1,882	
144	573	845	1,103	1,376	1,649	1,921	2,179	

Series 16								
Length Up To	Overall Finished Width							
42	63	84	105	126	147	168		
36	263	379	481	598	715	831	933	
48	321	437	568	714	831	976	1,078	
72	379	553	713	888	1,063	1,237	1,397	
84	437	611	800	1,004	1,179	1,382	1,542	
108	495	727	945	1,178	1,411	1,643	1,861	
120	553	785	1,032	1,294	1,527	1,788	2,006	
144	611	901	1,177	1,468	1,759	2,049	2,325	

RING TOP DRAPERIES: 2.5 Fullness — Unlined

Sizes and series numbers beyond what is listed in the charts below are available—please submit these quote requests via fax or email.

Number of Widths							
2	3	4	5	6	7	8	

Number of Widths							
2	3	4	5	6	7	8	

Series 17

Length Up To	Overall Finished Width						
	42	63	84	105	126	147	168
36	277	399	507	630	753	875	983
48	339	461	600	754	877	1,030	1,138
72	401	585	755	940	1,125	1,309	1,479
84	463	647	848	1,064	1,249	1,464	1,634
108	525	771	1,003	1,250	1,497	1,743	1,975
120	587	833	1,096	1,374	1,621	1,898	2,130
144	649	957	1,251	1,560	1,869	2,177	2,471

Series 18

Length Up To	Overall Finished Width						
	42	63	84	105	126	147	168
36	291	419	533	662	791	919	1,033
48	357	485	632	794	923	1,084	1,198
72	423	617	797	992	1,187	1,381	1,561
84	489	683	896	1,124	1,319	1,546	1,726
108	555	815	1,061	1,322	1,583	1,843	2,089
120	621	881	1,160	1,454	1,715	2,008	2,254
144	687	1,013	1,325	1,652	1,979	2,305	2,617

Series 19

Length Up To	Overall Finished Width						
	42	63	84	105	126	147	168
36	305	439	559	694	829	963	1,083
48	375	509	664	834	969	1,138	1,258
72	445	649	839	1,044	1,249	1,453	1,643
84	515	719	944	1,184	1,389	1,628	1,818
108	585	859	1,119	1,394	1,669	1,943	2,203
120	655	929	1,224	1,534	1,809	2,118	2,378
144	725	1,069	1,399	1,744	2,089	2,433	2,763

Series 20

Length Up To	Overall Finished Width						
	42	63	84	105	126	147	168
36	319	459	585	726	867	1,007	1,133
48	393	533	696	874	1,015	1,192	1,318
72	467	681	881	1,096	1,311	1,525	1,725
84	541	755	992	1,244	1,459	1,710	1,910
108	615	903	1,177	1,466	1,755	2,043	2,317
120	689	977	1,288	1,614	1,903	2,228	2,502
144	763	1,125	1,473	1,836	2,199	2,561	2,909

Series 21

Length Up To	Overall Finished Width						
	42	63	84	105	126	147	168
36	333	479	611	758	905	1,051	1,183
48	411	557	728	914	1,061	1,246	1,378
72	489	713	923	1,148	1,373	1,597	1,807
84	567	791	1,040	1,304	1,529	1,792	2,002
108	645	947	1,235	1,538	1,841	2,143	2,431
120	723	1,025	1,352	1,694	1,997	2,338	2,626
144	801	1,181	1,547	1,928	2,309	2,689	3,055

Series 22

Length Up To	Overall Finished Width						
	42	63	84	105	126	147	168
36	347	499	637	790	943	1,095	1,233
48	429	581	760	954	1,107	1,300	1,438
72	511	745	965	1,200	1,435	1,669	1,889
84	593	827	1,088	1,364	1,599	1,874	2,094
108	675	991	1,293	1,610	1,927	2,243	2,545
120	757	1,073	1,416	1,774	2,091	2,448	2,750
144	839	1,237	1,621	2,020	2,419	2,817	3,201

Series 23

Length Up To	Overall Finished Width						
	42	63	84	105	126	147	168
36	361	519	663	822	981	1,139	1,283
48	447	605	792	994	1,153	1,354	1,498
72	533	777	1,007	1,252	1,497	1,741	1,971
84	619	863	1,136	1,424	1,669	1,956	2,186
108	705	1,035	1,351	1,682	2,013	2,343	2,659
120	791	1,121	1,480	1,854	2,185	2,558	2,874
144	877	1,293	1,695	2,112	2,529	2,945	3,347

Series 24

Length Up To	Overall Finished Width						
	42	63	84	105	126	147	168
36	375	539	689	854	1,019	1,183	1,333
48	465	629	824	1,034	1,199	1,408	1,558
72	555	809	1,049	1,304	1,559	1,813	2,053
84	645	899	1,184	1,484	1,739	2,038	2,278
108	735	1,079	1,409	1,754	2,099	2,443	2,773
120	825	1,169	1,544	1,934	2,279	2,668	2,998
144	915	1,349	1,769	2,204	2,639	3,073	3,493

Series 25

Length Up To	Overall Finished Width						
	42	63	84	105	126	147	168
36	396	569	728	902	1,076	1,249	1,408
48	492	665	872	1,094	1,268	1,489	1,648
72	588	857	1,112	1,382	1,652	1,921	2,176
84	684	953	1,256	1,574	1,844	2,161	2,416
108	780	1,145	1,496	1,862	2,228	2,593	2,944
120	876	1,241	1,640	2,054	2,420	2,833	3,184
144	972	1,433	1,880	2,342	2,804	3,265	3,712

Series 26

Length Up To	Overall Finished Width						
	42	63	84	105	126	147	168
36	410	589	754	934	1,114	1,293	1,458
48	510	689	904	1,134	1,314	1,543	1,708
72	610	889	1,154	1,434	1,714	1,993	2,258
84	710	989	1,304	1,634	1,914	2,243	2,508
108	810	1,189	1,554	1,934	2,314	2,693	3,058
120	910	1,289	1,704	2,134	2,514	2,943	3,308
144	1,010	1,489	1,954	2,434	2,914	3,393	3,858

RING TOP DRAPERIES: 2.5 Fullness — Lined (Lining 01000)

Sizes and series numbers beyond what is listed in the charts below are available—please submit these quote requests via fax or email.

Number of Widths							
2	3	4	5	6	7	8	

Number of Widths							
2	3	4	5	6	7	8	

Series 7								
Length Up To	Overall Finished Width							
	42	63	84	105	126	147	168	
36	246	356	449	559	669	779	872	
48	267	377	481	601	711	832	925	
60	277	398	512	633	753	884	988	
72	288	419	533	664	795	926	1,040	
84	309	440	565	706	837	979	1,093	
96	319	461	596	738	879	1,031	1,156	
101	330	471	607	748	900	1,042	1,177	

Series 8								
Length Up To	Overall Finished Width							
	42	63	84	105	126	147	168	
36	263	381	482	599	717	834	935	
48	289	407	521	651	769	899	1,000	
60	302	433	560	690	821	964	1,078	
72	315	459	586	729	873	1,016	1,143	
84	341	485	625	781	925	1,081	1,208	
96	354	511	664	820	977	1,146	1,286	
101	367	524	677	833	1,003	1,159	1,312	

Series 9								
Length Up To	Overall Finished Width							
	42	63	84	105	126	147	168	
36	277	401	508	631	755	878	985	
48	307	431	553	691	815	953	1,060	
60	322	461	598	736	875	1,028	1,150	
72	337	491	628	781	935	1,088	1,225	
84	367	521	673	841	995	1,163	1,300	
96	382	551	718	886	1,055	1,238	1,390	
101	397	566	733	901	1,085	1,253	1,420	

Series 10								
Length Up To	Overall Finished Width							
	42	63	84	105	126	147	168	
36	291	421	534	663	793	922	1,035	
48	325	455	585	731	861	1,007	1,120	
60	342	489	636	782	929	1,092	1,222	
72	359	523	670	833	997	1,160	1,307	
84	393	557	721	901	1,065	1,245	1,392	
96	410	591	772	952	1,133	1,330	1,494	
101	427	608	789	969	1,167	1,347	1,528	

Series 11								
Length Up To	Overall Finished Width							
	42	63	84	105	126	147	168	
36	305	441	560	695	831	966	1,085	
48	343	479	617	771	907	1,061	1,180	
60	362	517	674	828	983	1,156	1,294	
72	381	555	712	885	1,059	1,232	1,389	
84	419	593	769	961	1,135	1,327	1,484	
96	438	631	826	1,018	1,211	1,422	1,598	
101	457	650	845	1,037	1,249	1,441	1,636	

Series 12								
Length Up To	Overall Finished Width							
	42	63	84	105	126	147	168	
36	319	461	586	727	869	1,010	1,135	
48	361	503	649	811	953	1,115	1,240	
60	382	545	712	874	1,037	1,220	1,366	
72	403	587	754	937	1,121	1,304	1,471	
84	445	629	817	1,021	1,205	1,409	1,576	
96	466	671	880	1,084	1,289	1,514	1,702	
101	487	692	901	1,105	1,331	1,535	1,744	

Series 13								
Length Up To	Overall Finished Width							
	42	63	84	105	126	147	168	
36	333	481	612	759	907	1,054	1,185	
48	379	527	681	851	999	1,169	1,300	
60	402	573	750	920	1,091	1,284	1,438	
72	425	619	796	989	1,183	1,376	1,553	
84	471	665	865	1,081	1,275	1,491	1,668	
96	494	711	934	1,150	1,367	1,606	1,806	
101	517	734	957	1,173	1,413	1,629	1,852	

Series 14								
Length Up To	Overall Finished Width							
	42	63	84	105	126	147	168	
36	347	501	638	791	945	1,098	1,235	
48	397	551	713	891	1,045	1,223	1,360	
60	422	601	788	966	1,145	1,348	1,510	
72	447	651	838	1,041	1,245	1,448	1,635	
84	497	701	913	1,141	1,345	1,573	1,760	
96	522	751	988	1,216	1,445	1,698	1,910	
101	547	776	1,013	1,241	1,495	1,723	1,960	

Series 15								
Length Up To	Overall Finished Width							
	42	63	84	105	126	147	168	
36	361	521	664	823	983	1,142	1,285	
48	415	575	745	931	1,091	1,277	1,420	
60	442	629	826	1,012	1,199	1,412	1,582	
72	469	683	880	1,093	1,307	1,520	1,717	
84	523	737	961	1,201	1,415	1,655	1,852	
96	550	791	1,042	1,282	1,523	1,790	2,014	
101	577	818	1,069	1,309	1,577	1,817	2,068	

Series 16								
Length Up To	Overall Finished Width							
	42	63	84	105	126	147	168	
36	375	541	690	855	1,021	1,186	1,335	
48	433	599	777	971	1,137	1,331	1,480	
60	462	657	864	1,058	1,253	1,476	1,654	
72	491	715	922	1,145	1,369	1,592	1,799	
84	549	773	1,009	1,261	1,485	1,737	1,944	
96	578	831	1,096	1,348	1,601	1,882	2,118	
101	607	860	1,125	1,377	1,659	1,911	2,176	

RING TOP DRAPERIES: 2.5 Fullness — Lined (Lining 01000)

Sizes and series numbers beyond what is listed in the charts below are available—please submit these quote requests via fax or email.

Number of Widths							
2	3	4	5	6	7	8	

Number of Widths							
2	3	4	5	6	7	8	

Series 17

Length Up To	Overall Finished Width						
	42	63	84	105	126	147	168
36	389	561	716	887	1,059	1,230	1,385
48	451	623	809	1,011	1,183	1,385	1,540
60	482	685	902	1,104	1,307	1,540	1,726
72	513	747	964	1,197	1,431	1,664	1,881
84	575	809	1,057	1,321	1,555	1,819	2,036
96	606	871	1,150	1,414	1,679	1,974	2,222
101	637	902	1,181	1,445	1,741	2,005	2,284

Series 18

Length Up To	Overall Finished Width						
	42	63	84	105	126	147	168
36	403	581	742	919	1,097	1,274	1,435
48	469	647	841	1,051	1,229	1,439	1,600
60	502	713	940	1,150	1,361	1,604	1,798
72	535	779	1,006	1,249	1,493	1,736	1,963
84	601	845	1,105	1,381	1,625	1,901	2,128
96	634	911	1,204	1,480	1,757	2,066	2,326
101	667	944	1,237	1,513	1,823	2,099	2,392

Series 19

Length Up To	Overall Finished Width						
	42	63	84	105	126	147	168
36	417	601	768	951	1,135	1,318	1,485
48	487	671	873	1,091	1,275	1,493	1,660
60	522	741	978	1,196	1,415	1,668	1,870
72	557	811	1,048	1,301	1,555	1,808	2,045
84	627	881	1,153	1,441	1,695	1,983	2,220
96	662	951	1,258	1,546	1,835	2,158	2,430
101	697	986	1,293	1,581	1,905	2,193	2,500

Series 20

Length Up To	Overall Finished Width						
	42	63	84	105	126	147	168
36	431	621	794	983	1,173	1,362	1,535
48	505	695	905	1,131	1,321	1,547	1,720
60	542	769	1,016	1,242	1,469	1,732	1,942
72	579	843	1,090	1,353	1,617	1,880	2,127
84	653	917	1,201	1,501	1,765	2,065	2,312
96	690	991	1,312	1,612	1,913	2,250	2,534
101	727	1,028	1,349	1,649	1,987	2,287	2,608

Series 21

Length Up To	Overall Finished Width						
	42	63	84	105	126	147	168
36	445	641	820	1,015	1,211	1,406	1,585
48	523	719	937	1,171	1,367	1,601	1,780
60	562	797	1,054	1,288	1,523	1,796	2,014
72	601	875	1,132	1,405	1,679	1,952	2,209
84	679	953	1,249	1,561	1,835	2,147	2,404
96	718	1,031	1,366	1,678	1,991	2,342	2,638
101	757	1,070	1,405	1,717	2,069	2,381	2,716

Series 22

Length Up To	Overall Finished Width						
	42	63	84	105	126	147	168
36	459	661	846	1,047	1,249	1,450	1,635
48	541	743	969	1,211	1,413	1,655	1,840
60	582	825	1,092	1,334	1,577	1,860	2,086
72	623	907	1,174	1,457	1,741	2,024	2,291
84	705	989	1,297	1,621	1,905	2,229	2,496
96	746	1,071	1,420	1,744	2,069	2,434	2,742
101	787	1,112	1,461	1,785	2,151	2,475	2,824

Series 23

Length Up To	Overall Finished Width						
	42	63	84	105	126	147	168
36	473	681	872	1,079	1,287	1,494	1,685
48	559	767	1,001	1,251	1,459	1,709	1,900
60	602	853	1,130	1,380	1,631	1,924	2,158
72	645	939	1,216	1,509	1,803	2,096	2,373
84	731	1,025	1,345	1,681	1,975	2,311	2,588
96	774	1,111	1,474	1,810	2,147	2,526	2,846
101	817	1,154	1,517	1,853	2,233	2,569	2,932

Series 24

Length Up To	Overall Finished Width						
	42	63	84	105	126	147	168
36	487	701	898	1,111	1,325	1,538	1,735
48	577	791	1,033	1,291	1,505	1,763	1,960
60	622	881	1,168	1,426	1,685	1,988	2,230
72	667	971	1,258	1,561	1,865	2,168	2,455
84	757	1,061	1,393	1,741	2,045	2,393	2,680
96	802	1,151	1,528	1,876	2,225	2,618	2,950
101	847	1,196	1,573	1,921	2,315	2,663	3,040

Series 25

Length Up To	Overall Finished Width						
	42	63	84	105	126	147	168
36	508	731	937	1,159	1,382	1,604	1,810
48	604	827	1,081	1,351	1,574	1,844	2,050
60	652	923	1,225	1,495	1,766	2,084	2,338
72	700	1,019	1,321	1,639	1,958	2,276	2,578
84	796	1,115	1,465	1,831	2,150	2,516	2,818
96	844	1,211	1,609	1,975	2,342	2,756	3,106
101	892	1,259	1,657	2,023	2,438	2,804	3,202

Series 26

Length Up To	Overall Finished Width						
	42	63	84	105	126	147	168
36	522	751	963	1,191	1,420	1,648	1,860
48	622	851	1,113	1,391	1,620	1,898	2,110
60	672	951	1,263	1,541	1,820	2,148	2,410
72	722	1,051	1,363	1,691	2,020	2,348	2,660
84	822	1,151	1,513	1,891	2,220	2,598	2,910
96	872	1,251	1,663	2,041	2,420	2,848	3,210
101	922	1,301	1,713	2,091	2,520	2,898	3,310

RING TOP DRAPERIES: 3 Fullness — Unlined

Sizes and series numbers beyond what is listed in the charts below are available—please submit these quote requests via fax or email.

Number of Widths						
3	4	5	6	8	9	10

Number of Widths						
3	4	5	6	8	9	10

Series 7							
Length Up To	Overall Finished Width						
	42	63	84	105	126	147	168
36	165	226	272	333	426	487	533
48	186	257	314	375	479	550	607
72	228	310	377	459	594	676	743
84	249	341	419	501	647	739	817
108	291	394	482	585	762	865	953
120	312	425	524	627	815	928	1,027
144	354	478	587	711	930	1,054	1,163

Series 8							
Length Up To	Overall Finished Width						
	42	63	84	105	126	147	168
36	190	258	312	381	489	557	611
48	216	297	364	433	554	635	702
72	268	362	442	537	697	791	871
84	294	401	494	589	762	869	962
108	346	466	572	693	905	1,025	1,131
120	372	505	624	745	970	1,103	1,222
144	424	570	702	849	1,113	1,259	1,391

Series 9							
Length Up To	Overall Finished Width						
	42	63	84	105	126	147	168
36	210	284	344	419	539	613	673
48	240	329	404	479	614	703	778
72	300	404	494	599	779	883	973
84	330	449	554	659	854	973	1,078
108	390	524	644	779	1,019	1,153	1,273
120	420	569	704	839	1,094	1,243	1,378
144	480	644	794	959	1,259	1,423	1,573

Series 10							
Length Up To	Overall Finished Width						
	42	63	84	105	126	147	168
36	230	310	376	457	589	669	735
48	264	361	444	525	674	771	854
72	332	446	546	661	861	975	1,075
84	366	497	614	729	946	1,077	1,194
108	434	582	716	865	1,133	1,281	1,415
120	468	633	784	933	1,218	1,383	1,534
144	536	718	886	1,069	1,405	1,587	1,755

Series 11							
Length Up To	Overall Finished Width						
	42	63	84	105	126	147	168
36	250	336	408	495	639	725	797
48	288	393	484	571	734	839	930
72	364	488	598	723	943	1,067	1,177
84	402	545	674	799	886	1,181	1,310
108	478	545	788	951	1,247	1,409	1,557
120	516	697	864	1,027	1,342	1,523	1,690
144	592	792	978	1,179	1,551	1,751	1,937

Series 12							
Length Up To	Overall Finished Width						
	42	63	84	105	126	147	168
36	270	362	440	533	689	781	859
48	312	425	524	617	794	907	1,006
72	396	530	650	785	1,025	1,159	1,279
84	438	593	734	869	1,130	1,285	1,426
108	522	698	860	1,037	1,361	1,537	1,699
120	564	761	944	1,121	1,466	1,663	1,846
144	648	866	1,070	1,289	1,697	1,915	2,119

Series 13							
Length Up To	Overall Finished Width						
	42	63	84	105	126	147	168
36	290	388	472	571	739	837	921
48	336	457	564	663	854	975	1,082
72	428	572	702	847	1,107	1,251	1,381
84	474	641	794	939	1,222	1,389	1,542
108	566	756	932	1,123	1,475	1,665	1,841
120	612	825	1,024	1,215	1,590	1,803	2,002
144	704	940	1,162	1,399	1,843	2,079	2,301

Series 14							
Length Up To	Overall Finished Width						
	42	63	84	105	126	147	168
36	310	414	504	609	789	893	983
48	360	489	604	709	914	1,043	1,158
72	460	614	754	909	1,189	1,343	1,483
84	510	689	854	1,009	1,314	1,493	1,658
108	610	814	1,004	1,209	1,589	1,793	1,983
120	660	889	1,104	1,309	1,714	1,943	2,158
144	760	1,014	1,254	1,509	1,989	2,243	2,483

Series 15							
Length Up To	Overall Finished Width						
	42	63	84	105	126	147	168
36	330	440	536	647	839	949	1,045
48	384	521	644	755	974	1,111	1,234
72	492	656	806	971	1,271	1,435	1,585
84	546	737	914	1,079	1,406	1,597	1,774
108	654	872	1,076	1,295	1,703	1,921	2,125
120	708	953	1,184	1,403	1,838	2,083	2,314
144	816	1,088	1,346	1,619	2,135	2,407	2,665

Series 16							
Length Up To	Overall Finished Width						
	42	63	84	105	126	147	168
36	350	466	568	685	889	1,005	1,107
48	408	553	684	801	1,034	1,179	1,310
72	524	698	858	1,033	1,353	1,527	1,687
84	582	785	974	1,149	1,498	1,701	1,890
108	698	930	1,148	1,381	1,817	2,049	2,267
120	756	1,017	1,264	1,497	1,962	2,223	2,470
144	872	1,162	1,438	1,729	2,281	2,571	2,847

RING TOP DRAPERIES: 3 Fullness — Unlined

Sizes and series numbers beyond what is listed in the charts below are available—please submit these quote requests via fax or email.

Number of Widths						
3	4	5	6	8	9	10

Number of Widths						
3	4	5	6	8	9	10

Series 17

Length Up To	Overall Finished Width						
	42	63	84	105	126	147	168
36	370	492	600	723	939	1,061	1,169
48	432	585	724	847	1,094	1,247	1,386
72	556	740	910	1,095	1,435	1,619	1,789
84	618	833	1,034	1,219	1,590	1,805	2,006
108	742	988	1,220	1,467	1,931	2,177	2,409
120	804	1,081	1,344	1,591	2,086	2,363	2,626
144	928	1,236	1,530	1,839	2,427	2,735	3,029

Series 18

Length Up To	Overall Finished Width						
	42	63	84	105	126	147	168
36	390	518	632	761	989	1,117	1,231
48	456	617	764	893	1,154	1,315	1,462
72	588	782	962	1,157	1,517	1,711	1,891
84	654	881	1,094	1,289	1,682	1,909	2,122
108	786	1,046	1,292	1,553	2,045	2,305	2,551
120	852	1,145	1,424	1,685	2,210	2,503	2,782
144	984	1,310	1,622	1,949	2,573	2,899	3,211

Series 19

Length Up To	Overall Finished Width						
	42	63	84	105	126	147	168
36	410	544	664	799	1,039	1,173	1,293
48	480	649	804	939	1,214	1,383	1,538
72	620	824	1,014	1,219	1,599	1,803	1,993
84	690	929	1,154	1,359	1,774	2,013	2,238
108	830	1,104	1,364	1,639	2,159	2,433	2,693
120	900	1,209	1,504	1,779	2,334	2,643	2,938
144	1,040	1,384	1,714	2,059	2,719	3,063	3,393

Series 20

Length Up To	Overall Finished Width						
	42	63	84	105	126	147	168
36	430	570	696	837	1,089	1,229	1,355
48	504	681	844	985	1,274	1,451	1,614
72	652	866	1,066	1,281	1,681	1,895	2,095
84	726	977	1,214	1,429	1,866	2,117	2,354
108	874	1,162	1,436	1,725	2,273	2,561	2,835
120	948	1,273	1,584	1,873	2,458	2,783	3,094
144	1,096	1,458	1,806	2,169	2,865	3,227	3,575

Series 21

Length Up To	Overall Finished Width						
	42	63	84	105	126	147	168
36	450	596	728	875	1,139	1,285	1,417
48	528	713	884	1,031	1,334	1,519	1,690
72	684	908	1,118	1,343	1,763	1,987	2,197
84	762	1,025	1,274	1,499	1,958	2,221	2,470
108	918	1,220	1,508	1,811	2,387	2,689	2,977
120	996	1,337	1,664	1,967	2,582	2,923	3,250
144	1,152	1,532	1,898	2,279	3,011	3,391	3,757

Series 22

Length Up To	Overall Finished Width						
	42	63	84	105	126	147	168
36	470	622	760	913	1,189	1,341	1,479
48	552	745	924	1,077	1,394	1,587	1,766
72	716	950	1,170	1,405	1,845	2,079	2,299
84	798	1,073	1,334	1,569	2,050	2,325	2,586
108	962	1,278	1,580	1,897	2,501	2,817	3,119
120	1,044	1,401	1,744	2,061	2,706	3,063	3,406
144	1,208	1,606	1,990	2,389	3,157	3,555	3,939

Series 23

Length Up To	Overall Finished Width						
	42	63	84	105	126	147	168
36	490	648	792	951	1,239	1,397	1,541
48	576	777	964	1,123	1,454	1,655	1,842
72	748	992	1,222	1,467	1,927	2,171	2,401
84	834	1,121	1,394	1,639	2,142	2,429	2,702
108	1,006	1,336	1,652	1,983	2,615	2,945	3,261
120	1,092	1,465	1,824	2,155	2,830	3,203	3,562
144	1,264	1,680	2,082	2,499	3,303	3,719	4,121

Series 24

Length Up To	Overall Finished Width						
	42	63	84	105	126	147	168
36	510	674	824	989	1,289	1,453	1,603
48	600	809	1,004	1,169	1,514	1,723	1,918
72	780	1,034	1,274	1,529	2,009	2,263	2,503
84	870	1,169	1,454	1,709	2,234	2,533	2,818
108	1,050	1,394	1,724	2,069	2,729	3,073	3,403
120	1,140	1,529	1,904	2,249	2,954	3,343	3,718
144	1,320	1,754	2,174	2,609	3,449	3,883	4,303

Series 25

Length Up To	Overall Finished Width						
	42	63	84	105	126	147	168
36	540	713	872	1,046	1,364	1,537	1,696
48	636	857	1,064	1,238	1,604	1,825	2,032
72	828	1,097	1,352	1,622	2,132	2,401	2,656
84	924	1,241	1,544	1,814	2,372	2,689	2,992
108	1,116	1,481	1,832	2,198	2,900	3,265	3,616
120	1,212	1,625	2,024	2,390	3,140	3,553	3,952
144	1,404	1,865	2,312	2,774	3,668	4,129	4,576

Series 26

Length Up To	Overall Finished Width						
	42	63	84	105	126	147	168
36	560	739	904	1,084	1,414	1,593	1,758
48	660	889	1,104	1,284	1,664	1,893	2,108
72	860	1,139	1,404	1,684	2,214	2,493	2,758
84	960	1,289	1,604	1,884	2,464	2,793	3,108
108	1,160	1,539	1,904	2,284	3,014	3,393	3,758
120	1,260	1,689	2,104	2,484	3,264	3,693	4,108
144	1,460	1,939	2,404	2,884	3,814	4,293	4,758

RING TOP DRAPERIES: 3 Fullness — Lined (Lining 01000)

Sizes and series numbers beyond what is listed in the charts below are available—please submit these quote requests via fax or email.

Number of Widths						
3	4	5	6	8	9	10

Number of Widths						
3	4	5	6	8	9	10

Series 7							
Length Up To	Overall Finished Width						
	42	63	84	105	126	147	168
36	292	417	511	636	777	902	995
48	313	449	553	678	830	965	1,069
60	334	480	584	720	893	1,028	1,132
72	355	501	616	762	945	1,091	1,205
84	376	533	658	804	998	1,154	1,279
96	397	564	689	846	1,061	1,217	1,342
101	408	575	700	867	1,082	1,249	1,373

Series 8							
Length Up To	Overall Finished Width						
	42	63	84	105	126	147	168
36	317	450	551	683	840	972	1,073
48	343	489	603	735	905	1,050	1,164
60	369	528	642	787	983	1,128	1,242
72	395	554	681	839	1,048	1,206	1,333
84	421	593	733	891	1,113	1,284	1,424
96	447	632	772	943	1,191	1,362	1,502
101	460	645	785	969	1,217	1,401	1,541

Series 9							
Length Up To	Overall Finished Width						
	42	63	84	105	126	147	168
36	337	476	583	721	890	1,028	1,135
48	367	521	643	781	965	1,118	1,240
60	397	566	688	841	1,055	1,208	1,330
72	427	596	733	901	1,130	1,298	1,435
84	457	641	793	961	1,205	1,388	1,540
96	487	686	838	1,021	1,295	1,478	1,630
101	502	701	853	1,051	1,325	1,523	1,675

Series 10							
Length Up To	Overall Finished Width						
	42	63	84	105	126	147	168
36	357	502	615	759	940	1,084	1,197
48	391	553	683	827	1,025	1,186	1,316
60	425	604	734	895	1,127	1,288	1,418
72	459	638	785	963	1,212	1,390	1,537
84	493	689	853	1,031	1,297	1,492	1,656
96	527	740	904	1,099	1,399	1,594	1,758
101	544	757	921	1,133	1,433	1,645	1,809

Series 11							
Length Up To	Overall Finished Width						
	42	63	84	105	126	147	168
36	377	528	647	797	990	1,140	1,259
48	415	585	723	873	1,085	1,254	1,392
60	453	642	780	949	1,199	1,368	1,506
72	491	680	837	1,025	1,294	1,482	1,639
84	529	737	913	1,101	1,389	1,596	1,772
96	567	794	970	1,177	1,503	1,710	1,886
101	586	813	989	1,215	1,541	1,767	1,943

Series 12							
Length Up To	Overall Finished Width						
	42	63	84	105	126	147	168
36	397	554	679	835	1,040	1,196	1,321
48	439	617	763	919	1,145	1,322	1,468
60	481	680	826	1,003	1,271	1,448	1,594
72	523	722	889	1,087	1,376	1,574	1,741
84	565	785	973	1,171	1,481	1,700	1,888
96	607	848	1,036	1,255	1,607	1,826	2,014
101	628	869	1,057	1,297	1,649	1,889	2,077

Series 13							
Length Up To	Overall Finished Width						
	42	63	84	105	126	147	168
36	417	580	711	873	1,090	1,252	1,383
48	463	649	803	965	1,205	1,390	1,544
60	509	718	872	1,057	1,343	1,528	1,682
72	555	764	941	1,149	1,458	1,666	1,843
84	601	833	1,033	1,241	1,573	1,804	2,004
96	647	902	1,102	1,333	1,711	1,942	2,142
101	670	925	1,125	1,379	1,757	2,011	2,211

Series 14							
Length Up To	Overall Finished Width						
	42	63	84	105	126	147	168
36	437	606	743	911	1,140	1,308	1,445
48	487	681	843	1,011	1,265	1,458	1,620
60	537	756	918	1,111	1,415	1,608	1,770
72	587	806	993	1,211	1,540	1,758	1,945
84	637	881	1,093	1,311	1,665	1,908	2,120
96	687	956	1,168	1,411	1,815	2,058	2,270
101	712	981	1,193	1,461	1,865	2,133	2,345

Series 15							
Length Up To	Overall Finished Width						
	42	63	84	105	126	147	168
36	457	632	775	949	1,190	1,364	1,507
48	511	713	883	1,057	1,325	1,526	1,696
60	565	794	964	1,165	1,487	1,688	1,858
72	619	848	1,045	1,273	1,622	1,850	2,047
84	673	929	1,153	1,381	1,757	2,012	2,236
96	727	1,010	1,234	1,489	1,919	2,174	2,398
101	754	1,037	1,261	1,543	1,973	2,255	2,479

Series 16							
Length Up To	Overall Finished Width						
	42	63	84	105	126	147	168
36	477	658	807	987	1,240	1,420	1,569
48	535	745	923	1,103	1,385	1,594	1,772
60	593	832	1,010	1,219	1,559	1,768	1,946
72	651	890	1,097	1,335	1,704	1,942	2,149
84	709	977	1,213	1,451	1,849	2,116	2,352
96	767	1,064	1,300	1,567	2,023	2,290	2,526
101	796	1,093	1,329	1,625	2,081	2,377	2,613

RING TOP DRAPERIES: 3 Fullness — Lined (Lining 01000)

Sizes and series numbers beyond what is listed in the charts below are available—please submit these quote requests via fax or email.

Number of Widths						
3	4	5	6	8	9	10

Number of Widths						
3	4	5	6	8	9	10

Series 17

Length Up To	Overall Finished Width						
	42	63	84	105	126	147	168
36	497	684	839	1,025	1,290	1,476	1,631
48	559	777	963	1,149	1,445	1,662	1,848
60	621	870	1,056	1,273	1,631	1,848	2,034
72	683	932	1,149	1,397	1,786	2,034	2,251
84	745	1,025	1,273	1,521	1,941	2,220	2,468
96	807	1,118	1,366	1,645	2,127	2,406	2,654
101	838	1,149	1,397	1,707	2,189	2,499	2,747

Series 18

Length Up To	Overall Finished Width						
	42	63	84	105	126	147	168
36	517	710	871	1,063	1,340	1,532	1,693
48	583	809	1,003	1,195	1,505	1,730	1,924
60	649	908	1,102	1,327	1,703	1,928	2,122
72	715	974	1,201	1,459	1,868	2,126	2,353
84	781	1,073	1,333	1,591	2,033	2,324	2,584
96	847	1,172	1,432	1,723	2,231	2,522	2,782
101	880	1,205	1,465	1,789	2,297	2,621	2,881

Series 19

Length Up To	Overall Finished Width						
	42	63	84	105	126	147	168
36	537	736	903	1,101	1,390	1,588	1,755
48	607	841	1,043	1,241	1,565	1,798	2,000
60	677	946	1,148	1,381	1,775	2,008	2,210
72	747	1,016	1,253	1,521	1,950	2,218	2,455
84	817	1,121	1,393	1,661	2,125	2,428	2,700
96	887	1,226	1,498	1,801	2,335	2,638	2,910
101	922	1,261	1,533	1,871	2,405	2,743	3,015

Series 20

Length Up To	Overall Finished Width						
	42	63	84	105	126	147	168
36	557	762	935	1,139	1,440	1,644	1,817
48	631	873	1,083	1,287	1,625	1,866	2,076
60	705	984	1,194	1,435	1,847	2,088	2,298
72	779	1,058	1,305	1,583	2,032	2,310	2,557
84	853	1,169	1,453	1,731	2,217	2,532	2,816
96	927	1,280	1,564	1,879	2,439	2,754	3,038
101	964	1,317	1,601	1,953	2,513	2,865	3,149

Series 21

Length Up To	Overall Finished Width						
	42	63	84	105	126	147	168
36	577	788	967	1,177	1,490	1,700	1,879
48	655	905	1,123	1,333	1,685	1,934	2,152
60	733	1,022	1,240	1,489	1,919	2,168	2,386
72	811	1,100	1,357	1,645	2,114	2,402	2,659
84	889	1,217	1,513	1,801	2,309	2,636	2,932
96	967	1,334	1,630	1,957	2,543	2,870	3,166
101	1,006	1,373	1,669	2,035	2,621	2,987	3,283

Series 22

Length Up To	Overall Finished Width						
	42	63	84	105	126	147	168
36	597	814	999	1,215	1,540	1,756	1,941
48	679	937	1,163	1,379	1,745	2,002	2,228
60	761	1,060	1,286	1,543	1,991	2,248	2,474
72	843	1,142	1,409	1,707	2,196	2,494	2,761
84	925	1,265	1,573	1,871	2,401	2,740	3,048
96	1,007	1,388	1,696	2,035	2,647	2,986	3,294
101	1,048	1,429	1,737	2,117	2,729	3,109	3,417

Series 23

Length Up To	Overall Finished Width						
	42	63	84	105	126	147	168
36	617	840	1,031	1,253	1,590	1,812	2,003
48	703	969	1,203	1,425	1,805	2,070	2,304
60	789	1,098	1,332	1,597	2,063	2,328	2,562
72	875	1,184	1,461	1,769	2,278	2,586	2,863
84	961	1,313	1,633	1,941	2,493	2,844	3,164
96	1,047	1,442	1,762	2,113	2,751	3,102	3,422
101	1,090	1,485	1,805	2,199	2,837	3,231	3,551

Series 24

Length Up To	Overall Finished Width						
	42	63	84	105	126	147	168
36	637	866	1,063	1,291	1,640	1,868	2,065
48	727	1,001	1,243	1,471	1,865	2,138	2,380
60	817	1,136	1,378	1,651	2,135	2,408	2,650
72	907	1,226	1,513	1,831	2,360	2,678	2,965
84	997	1,361	1,693	2,011	2,585	2,948	3,280
96	1,087	1,496	1,828	2,191	2,855	3,218	3,550
101	1,132	1,541	1,873	2,281	2,945	3,353	3,685

Series 25

Length Up To	Overall Finished Width						
	42	63	84	105	126	147	168
36	667	905	1,111	1,348	1,715	1,952	2,158
48	763	1,049	1,303	1,540	1,955	2,240	2,494
60	859	1,193	1,447	1,732	2,243	2,528	2,782
72	955	1,289	1,591	1,924	2,483	2,816	3,118
84	1,051	1,433	1,783	2,116	2,723	3,104	3,454
96	1,147	1,577	1,927	2,308	3,011	3,392	3,742
101	1,195	1,625	1,975	2,404	3,107	3,536	3,886

Series 26

Length Up To	Overall Finished Width						
	42	63	84	105	126	147	168
36	687	931	1,143	1,386	1,765	2,008	2,220
48	787	1,081	1,343	1,586	2,015	2,308	2,570
60	887	1,231	1,493	1,786	2,315	2,608	2,870
72	987	1,331	1,643	1,986	2,565	2,908	3,220
84	1,087	1,481	1,843	2,186	2,815	3,208	3,570
96	1,187	1,631	1,993	2,386	3,115	3,508	3,870
101	1,237	1,681	2,043	2,486	3,215	3,658	4,020

RING TOP DRAPERIES: 4 Fullness — Unlined

Sizes and series numbers beyond what is listed in the charts below are available—please submit these quote requests via fax or email.

Number of Widths						
4	5	7	8	10	12	13

Number of Widths						
4	5	7	8	10	12	13

Series 7							
Length Up To	Overall Finished Width						
	42	63	84	105	126	147	168
36	196	257	335	396	489	582	628
48	228	299	388	449	563	666	722
72	280	362	482	564	699	834	901
84	312	404	535	617	773	918	995
108	364	467	629	732	909	1,086	1,174
120	396	509	682	785	983	1,170	1,268
144	448	572	776	900	1,119	1,338	1,447

Series 8							
Length Up To	Overall Finished Width						
	42	63	84	105	126	147	168
36	229	297	390	459	567	674	728
48	268	349	455	524	658	778	845
72	333	427	572	667	827	986	1,066
84	372	479	637	732	918	1,090	1,183
108	437	557	754	875	1,087	1,298	1,404
120	476	609	819	940	1,178	1,402	1,521
144	541	687	936	1,083	1,347	1,610	1,742

Series 9							
Length Up To	Overall Finished Width						
	42	63	84	105	126	147	168
36	255	329	434	509	629	748	808
48	300	389	509	584	734	868	943
72	375	479	644	749	929	1,108	1,198
84	420	539	719	824	1,034	1,228	1,333
108	495	629	854	989	1,229	1,468	1,588
120	540	689	929	1,064	1,334	1,588	1,723
144	615	779	1,064	1,229	1,529	1,828	1,978

Series 10							
Length Up To	Overall Finished Width						
	42	63	84	105	126	147	168
36	281	361	478	559	691	822	888
48	332	429	563	644	810	958	1,041
72	417	531	716	831	1,031	1,230	1,330
84	468	599	801	916	1,150	1,366	1,483
108	553	701	954	1,103	1,371	1,638	1,772
120	604	769	1,039	1,188	1,490	1,774	1,925
144	689	871	1,192	1,375	1,711	2,046	2,214

Series 11							
Length Up To	Overall Finished Width						
	42	63	84	105	126	147	168
36	307	393	522	609	753	896	968
48	364	469	617	704	886	1,048	1,139
72	459	583	788	913	1,133	1,352	1,462
84	516	659	883	1,008	886	1,504	1,633
108	611	545	1,054	1,217	1,513	1,808	1,956
120	668	849	1,149	1,312	1,646	1,960	2,127
144	763	963	1,320	1,521	1,893	2,264	2,450

Series 12							
Length Up To	Overall Finished Width						
	42	63	84	105	126	147	168
36	333	425	566	659	815	970	1,048
48	396	509	671	764	962	1,138	1,237
72	501	635	860	995	1,235	1,474	1,594
84	564	719	965	1,100	1,382	1,642	1,783
108	669	845	1,154	1,331	1,655	1,978	2,140
120	732	929	1,259	1,436	1,802	2,146	2,329
144	837	1,055	1,448	1,667	2,075	2,482	2,686

Series 13							
Length Up To	Overall Finished Width						
	42	63	84	105	126	147	168
36	359	457	610	709	877	1,044	1,128
48	428	549	725	824	1,038	1,228	1,335
72	543	687	932	1,077	1,337	1,596	1,726
84	612	779	1,047	1,192	1,498	1,780	1,933
108	727	917	1,254	1,445	1,797	2,148	2,324
120	796	1,009	1,369	1,560	1,958	2,332	2,531
144	911	1,147	1,576	1,813	2,257	2,700	2,922

Series 14							
Length Up To	Overall Finished Width						
	42	63	84	105	126	147	168
36	385	489	654	759	939	1,118	1,208
48	460	589	779	884	1,114	1,318	1,433
72	585	739	1,004	1,159	1,439	1,718	1,858
84	660	839	1,129	1,284	1,614	1,918	2,083
108	785	989	1,354	1,559	1,939	2,318	2,508
120	860	1,089	1,479	1,684	2,114	2,518	2,733
144	985	1,239	1,704	1,959	2,439	2,918	3,158

Series 15							
Length Up To	Overall Finished Width						
	42	63	84	105	126	147	168
36	411	521	698	809	1,001	1,192	1,288
48	492	629	833	944	1,190	1,408	1,531
72	627	791	1,076	1,241	1,541	1,840	1,990
84	708	899	1,211	1,376	1,730	2,056	2,233
108	843	1,061	1,454	1,673	2,081	2,488	2,692
120	924	1,169	1,589	1,808	2,270	2,704	2,935
144	1,059	1,331	1,832	2,105	2,621	3,136	3,394

Series 16							
Length Up To	Overall Finished Width						
	42	63	84	105	126	147	168
36	437	553	742	859	1,063	1,266	1,368
48	524	669	887	1,004	1,266	1,498	1,629
72	669	843	1,148	1,323	1,643	1,962	2,122
84	756	959	1,293	1,468	1,846	2,194	2,383
108	901	1,133	1,554	1,787	2,223	2,658	2,876
120	988	1,249	1,699	1,932	2,426	2,890	3,137
144	1,133	1,423	1,960	2,251	2,803	3,354	3,630

RING TOP DRAPERIES: 4 Fullness — Unlined

Sizes and series numbers beyond what is listed in the charts below are available—please submit these quote requests via fax or email.

Number of Widths						
4	5	7	8	10	12	13

Number of Widths						
4	5	7	8	10	12	13

Series 17

Length Up To	Overall Finished Width						
	42	63	84	105	126	147	168
36	463	585	786	909	1,125	1,340	1,448
48	556	709	941	1,064	1,342	1,588	1,727
72	711	895	1,220	1,405	1,745	2,084	2,254
84	804	1,019	1,375	1,560	1,962	2,332	2,533
108	959	1,205	1,654	1,901	2,365	2,828	3,060
120	1,052	1,329	1,809	2,056	2,582	3,076	3,339
144	1,207	1,515	2,088	2,397	2,985	3,572	3,866

Series 18

Length Up To	Overall Finished Width						
	42	63	84	105	126	147	168
36	489	617	830	959	1,187	1,414	1,528
48	588	749	995	1,124	1,418	1,678	1,825
72	753	947	1,292	1,487	1,847	2,206	2,386
84	852	1,079	1,457	1,652	2,078	2,470	2,683
108	1,017	1,277	1,754	2,015	2,507	2,998	3,244
120	1,116	1,409	1,919	2,180	2,738	3,262	3,541
144	1,281	1,607	2,216	2,543	3,167	3,790	4,102

Series 19

Length Up To	Overall Finished Width						
	42	63	84	105	126	147	168
36	515	649	874	1,009	1,249	1,488	1,608
48	620	789	1,049	1,184	1,494	1,768	1,923
72	795	999	1,364	1,569	1,949	2,328	2,518
84	900	1,139	1,539	1,744	2,194	2,608	2,833
108	1,075	1,349	1,854	2,129	2,649	3,168	3,428
120	1,180	1,489	2,029	2,304	2,894	3,448	3,743
144	1,355	1,699	2,344	2,689	3,349	4,008	4,338

Series 20

Length Up To	Overall Finished Width						
	42	63	84	105	126	147	168
36	541	681	918	1,059	1,311	1,562	1,688
48	652	829	1,103	1,244	1,570	1,858	2,021
72	837	1,051	1,436	1,651	2,051	2,450	2,650
84	948	1,199	1,621	1,836	2,310	2,746	2,983
108	1,133	1,421	1,954	2,243	2,791	3,338	3,612
120	1,244	1,569	2,139	2,428	3,050	3,634	3,945
144	1,429	1,791	2,472	2,835	3,531	4,226	4,574

Series 21

Length Up To	Overall Finished Width						
	42	63	84	105	126	147	168
36	567	713	962	1,109	1,373	1,636	1,768
48	684	869	1,157	1,304	1,646	1,948	2,119
72	879	1,103	1,508	1,733	2,153	2,572	2,782
84	996	1,259	1,703	1,928	2,426	2,884	3,133
108	1,191	1,493	2,054	2,357	2,933	3,508	3,796
120	1,308	1,649	2,249	2,552	3,206	3,820	4,147
144	1,503	1,883	2,600	2,981	3,713	4,444	4,810

Series 22

Length Up To	Overall Finished Width						
	42	63	84	105	126	147	168
36	593	745	1,006	1,159	1,435	1,710	1,848
48	716	909	1,211	1,364	1,722	2,038	2,217
72	921	1,155	1,580	1,815	2,255	2,694	2,914
84	1,044	1,319	1,785	2,020	2,542	3,022	3,283
108	1,249	1,565	2,154	2,471	3,075	3,678	3,980
120	1,372	1,729	2,359	2,676	3,362	4,006	4,349
144	1,577	1,975	2,728	3,127	3,895	4,662	5,046

Series 23

Length Up To	Overall Finished Width						
	42	63	84	105	126	147	168
36	619	777	1,050	1,209	1,497	1,784	1,928
48	748	949	1,265	1,424	1,798	2,128	2,315
72	963	1,207	1,652	1,897	2,357	2,816	3,046
84	1,092	1,379	1,867	2,112	2,658	3,160	3,433
108	1,307	1,637	2,254	2,585	3,217	3,848	4,164
120	1,436	1,809	2,469	2,800	3,518	4,192	4,551
144	1,651	2,067	2,856	3,273	4,077	4,880	5,282

Series 24

Length Up To	Overall Finished Width						
	42	63	84	105	126	147	168
36	645	809	1,094	1,259	1,559	1,858	2,008
48	780	989	1,319	1,484	1,874	2,218	2,413
72	1,005	1,259	1,724	1,979	2,459	2,938	3,178
84	1,140	1,439	1,949	2,204	2,774	3,298	3,583
108	1,365	1,709	2,354	2,699	3,359	4,018	4,348
120	1,500	1,889	2,579	2,924	3,674	4,378	4,753
144	1,725	2,159	2,984	3,419	4,259	5,098	5,518

Series 25

Length Up To	Overall Finished Width						
	42	63	84	105	126	147	168
36	684	857	1,160	1,334	1,652	1,969	2,128
48	828	1,049	1,400	1,574	1,988	2,353	2,560
72	1,068	1,337	1,832	2,102	2,612	3,121	3,376
84	1,212	1,529	2,072	2,342	2,948	3,505	3,808
108	1,452	1,817	2,504	2,870	3,572	4,273	4,624
120	1,596	2,009	2,744	3,110	3,908	4,657	5,056
144	1,836	2,297	3,176	3,638	4,532	5,425	5,872

Series 26

Length Up To	Overall Finished Width						
	42	63	84	105	126	147	168
36	710	889	1,204	1,384	1,714	2,043	2,208
48	860	1,089	1,454	1,634	2,064	2,443	2,658
72	1,110	1,389	1,904	2,184	2,714	3,243	3,508
84	1,260	1,589	2,154	2,434	3,064	3,643	3,958
108	1,510	1,889	2,604	2,984	3,714	4,443	4,808
120	1,660	2,089	2,854	3,234	4,064	4,843	5,258
144	1,910	2,389	3,304	3,784	4,714	5,643	6,108

RING TOP DRAPERIES: 4 Fullness — Lined (Lining 01000)

Sizes and series numbers beyond what is listed in the charts below are available—please submit these quote requests via fax or email.

Number of Widths						
4	5	7	8	10	12	13

Number of Widths						
4	5	7	8	10	12	13

Series 7							
Length Up To	Overall Finished Width						
	42	63	84	105	126	147	168
36	369	494	649	789	945	1,117	1,240
48	400	536	701	841	1,019	1,201	1,334
60	432	567	754	904	1,082	1,285	1,418
72	453	599	796	957	1,155	1,369	1,513
84	484	641	848	1,009	1,229	1,453	1,607
96	516	672	901	1,072	1,292	1,537	1,691
101	526	683	911	1,093	1,323	1,568	1,733

Series 8							
Length Up To	Overall Finished Width						
	42	63	84	105	126	147	168
36	401	534	704	851	1,023	1,209	1,340
48	440	586	769	916	1,114	1,313	1,457
60	479	625	834	994	1,192	1,417	1,561
72	505	664	886	1,059	1,283	1,521	1,678
84	544	716	951	1,124	1,374	1,625	1,795
96	583	755	1,016	1,202	1,452	1,729	1,899
101	596	768	1,029	1,228	1,491	1,768	1,951

Series 9							
Length Up To	Overall Finished Width						
	42	63	84	105	126	147	168
36	427	566	748	901	1,085	1,283	1,420
48	472	626	823	976	1,190	1,403	1,555
60	517	671	898	1,066	1,280	1,523	1,675
72	547	716	958	1,141	1,385	1,643	1,810
84	592	776	1,033	1,216	1,490	1,763	1,945
96	637	821	1,108	1,306	1,580	1,883	2,065
101	652	836	1,123	1,336	1,625	1,928	2,125

Series 10							
Length Up To	Overall Finished Width						
	42	63	84	105	126	147	168
36	453	598	792	951	1,147	1,357	1,500
48	504	666	877	1,036	1,266	1,493	1,653
60	555	717	962	1,138	1,368	1,629	1,789
72	589	768	1,030	1,223	1,487	1,765	1,942
84	640	836	1,115	1,308	1,606	1,901	2,095
96	691	887	1,200	1,410	1,708	2,037	2,231
101	708	904	1,217	1,444	1,759	2,088	2,299

Series 11							
Length Up To	Overall Finished Width						
	42	63	84	105	126	147	168
36	479	630	836	1,001	1,209	1,431	1,580
48	536	706	931	1,096	1,342	1,583	1,751
60	593	763	1,026	1,210	1,456	1,735	1,903
72	631	820	1,102	1,305	1,589	1,887	2,074
84	688	896	1,197	1,400	1,722	2,039	2,245
96	745	953	1,292	1,514	1,836	2,191	2,397
101	764	972	1,311	1,552	1,893	2,248	2,473

Series 12							
Length Up To	Overall Finished Width						
	42	63	84	105	126	147	168
36	505	662	880	1,051	1,271	1,505	1,660
48	568	746	985	1,156	1,418	1,673	1,849
60	631	809	1,090	1,282	1,544	1,841	2,017
72	673	872	1,174	1,387	1,691	2,009	2,206
84	736	956	1,279	1,492	1,838	2,177	2,395
96	799	1,019	1,384	1,618	1,964	2,345	2,563
101	820	1,040	1,405	1,660	2,027	2,408	2,647

Series 13							
Length Up To	Overall Finished Width						
	42	63	84	105	126	147	168
36	531	694	924	1,101	1,333	1,579	1,740
48	600	786	1,039	1,216	1,494	1,763	1,947
60	669	855	1,154	1,354	1,632	1,947	2,131
72	715	924	1,246	1,469	1,793	2,131	2,338
84	784	1,016	1,361	1,584	1,954	2,315	2,545
96	853	1,085	1,476	1,722	2,092	2,499	2,729
101	876	1,108	1,499	1,768	2,161	2,568	2,821

Series 14							
Length Up To	Overall Finished Width						
	42	63	84	105	126	147	168
36	557	726	968	1,151	1,395	1,653	1,820
48	632	826	1,093	1,276	1,570	1,853	2,045
60	707	901	1,218	1,426	1,720	2,053	2,245
72	757	976	1,318	1,551	1,895	2,253	2,470
84	832	1,076	1,443	1,676	2,070	2,453	2,695
96	907	1,151	1,568	1,826	2,220	2,653	2,895
101	932	1,176	1,593	1,876	2,295	2,728	2,995

Series 15							
Length Up To	Overall Finished Width						
	42	63	84	105	126	147	168
36	583	758	1,012	1,201	1,457	1,727	1,900
48	664	866	1,147	1,336	1,646	1,943	2,143
60	745	947	1,282	1,498	1,808	2,159	2,359
72	799	1,028	1,390	1,633	1,997	2,375	2,602
84	880	1,136	1,525	1,768	2,186	2,591	2,845
96	961	1,217	1,660	1,930	2,348	2,807	3,061
101	988	1,244	1,687	1,984	2,429	2,888	3,169

Series 16							
Length Up To	Overall Finished Width						
	42	63	84	105	126	147	168
36	609	790	1,056	1,251	1,519	1,801	1,980
48	696	906	1,201	1,396	1,722	2,033	2,241
60	783	993	1,346	1,570	1,896	2,265	2,473
72	841	1,080	1,462	1,715	2,099	2,497	2,734
84	928	1,196	1,607	1,860	2,302	2,729	2,995
96	1,015	1,283	1,752	2,034	2,476	2,961	3,227
101	1,044	1,312	1,781	2,092	2,563	3,048	3,343

RING TOP DRAPERIES: 4 Fullness — Lined (Lining 01000)

Sizes and series numbers beyond what is listed in the charts below are available—please submit these quote requests via fax or email.

Number of Widths						
4	5	7	8	10	12	13

Number of Widths						
4	5	7	8	10	12	13

Series 17

Length Up To	Overall Finished Width						
	42	63	84	105	126	147	168
36	635	822	1,100	1,301	1,581	1,875	2,060
48	728	946	1,255	1,456	1,798	2,123	2,339
60	821	1,039	1,410	1,642	1,984	2,371	2,587
72	883	1,132	1,534	1,797	2,201	2,619	2,866
84	976	1,256	1,689	1,952	2,418	2,867	3,145
96	1,069	1,349	1,844	2,138	2,604	3,115	3,393
101	1,100	1,380	1,875	2,200	2,697	3,208	3,517

Series 18

Length Up To	Overall Finished Width						
	42	63	84	105	126	147	168
36	661	854	1,144	1,351	1,643	1,949	2,140
48	760	986	1,309	1,516	1,874	2,213	2,437
60	859	1,085	1,474	1,714	2,072	2,477	2,701
72	925	1,184	1,606	1,879	2,303	2,741	2,998
84	1,024	1,316	1,771	2,044	2,534	3,005	3,295
96	1,123	1,415	1,936	2,242	2,732	3,269	3,559
101	1,156	1,448	1,969	2,308	2,831	3,368	3,691

Series 19

Length Up To	Overall Finished Width						
	42	63	84	105	126	147	168
36	687	886	1,188	1,401	1,705	2,023	2,220
48	792	1,026	1,363	1,576	1,950	2,303	2,535
60	897	1,131	1,538	1,786	2,160	2,583	2,815
72	967	1,236	1,678	1,961	2,405	2,863	3,130
84	1,072	1,376	1,853	2,136	2,650	3,143	3,445
96	1,177	1,481	2,028	2,346	2,860	3,423	3,725
101	1,212	1,516	2,063	2,416	2,965	3,528	3,865

Series 20

Length Up To	Overall Finished Width						
	42	63	84	105	126	147	168
36	713	918	1,232	1,451	1,767	2,097	2,300
48	824	1,066	1,417	1,636	2,026	2,393	2,633
60	935	1,177	1,602	1,858	2,248	2,689	2,929
72	1,009	1,288	1,750	2,043	2,507	2,985	3,262
84	1,120	1,436	1,935	2,228	2,766	3,281	3,595
96	1,231	1,547	2,120	2,450	2,988	3,577	3,891
101	1,268	1,584	2,157	2,524	3,099	3,688	4,039

Series 21

Length Up To	Overall Finished Width						
	42	63	84	105	126	147	168
36	739	950	1,276	1,501	1,829	2,171	2,380
48	856	1,106	1,471	1,696	2,102	2,483	2,731
60	973	1,223	1,666	1,930	2,336	2,795	3,043
72	1,051	1,340	1,822	2,125	2,609	3,107	3,394
84	1,168	1,496	2,017	2,320	2,882	3,419	3,745
96	1,285	1,613	2,212	2,554	3,116	3,731	4,057
101	1,324	1,652	2,251	2,632	3,233	3,848	4,213

Series 22

Length Up To	Overall Finished Width						
	42	63	84	105	126	147	168
36	765	982	1,320	1,551	1,891	2,245	2,460
48	888	1,146	1,525	1,756	2,178	2,573	2,829
60	1,011	1,269	1,730	2,002	2,424	2,901	3,157
72	1,093	1,392	1,894	2,207	2,711	3,229	3,526
84	1,216	1,556	2,099	2,412	2,998	3,557	3,895
96	1,339	1,679	2,304	2,658	3,244	3,885	4,223
101	1,380	1,720	2,345	2,740	3,367	4,008	4,387

Series 23

Length Up To	Overall Finished Width						
	42	63	84	105	126	147	168
36	791	1,014	1,364	1,601	1,953	2,319	2,540
48	920	1,186	1,579	1,816	2,254	2,663	2,927
60	1,049	1,315	1,794	2,074	2,512	3,007	3,271
72	1,135	1,444	1,966	2,289	2,813	3,351	3,658
84	1,264	1,616	2,181	2,504	3,114	3,695	4,045
96	1,393	1,745	2,396	2,762	3,372	4,039	4,389
101	1,436	1,788	2,439	2,848	3,501	4,168	4,561

Series 24

Length Up To	Overall Finished Width						
	42	63	84	105	126	147	168
36	817	1,046	1,408	1,651	2,015	2,393	2,620
48	952	1,226	1,633	1,876	2,330	2,753	3,025
60	1,087	1,361	1,858	2,146	2,600	3,113	3,385
72	1,177	1,496	2,038	2,371	2,915	3,473	3,790
84	1,312	1,676	2,263	2,596	3,230	3,833	4,195
96	1,447	1,811	2,488	2,866	3,500	4,193	4,555
101	1,492	1,856	2,533	2,956	3,635	4,328	4,735

Series 25

Length Up To	Overall Finished Width						
	42	63	84	105	126	147	168
36	856	1,094	1,474	1,726	2,108	2,504	2,740
48	1,000	1,286	1,714	1,966	2,444	2,888	3,172
60	1,144	1,430	1,954	2,254	2,732	3,272	3,556
72	1,240	1,574	2,146	2,494	3,068	3,656	3,988
84	1,384	1,766	2,386	2,734	3,404	4,040	4,420
96	1,528	1,910	2,626	3,022	3,692	4,424	4,804
101	1,576	1,958	2,674	3,118	3,836	4,568	4,996

Series 26

Length Up To	Overall Finished Width						
	42	63	84	105	126	147	168
36	882	1,126	1,518	1,776	2,170	2,578	2,820
48	1,032	1,326	1,768	2,026	2,520	2,978	3,270
60	1,182	1,476	2,018	2,326	2,820	3,378	3,670
72	1,282	1,626	2,218	2,576	3,170	3,778	4,120
84	1,432	1,826	2,468	2,826	3,520	4,178	4,570
96	1,582	1,976	2,718	3,126	3,820	4,578	4,970
101	1,632	2,026	2,768	3,226	3,970	4,728	5,170

ROD POCKET DRAPERIES: 2 Fullness — Unlined

Chart pricing for rod pocket single or double. Sizes and series numbers beyond what is listed in the charts below are available—please submit these quote requests via fax or email.

Number of Widths							
2	3	4	4	5	6	7	

Number of Widths							
2	3	4	4	5	6	7	

Series 7								
Length Up To	Overall Finished Width							
	42	63	84	105	126	147	168	
36	115	186	230	230	301	345	410	
48	148	224	295	295	372	422	492	
72	192	301	383	383	492	575	678	
84	224	339	448	448	563	651	760	
108	268	416	536	536	684	804	946	
120	301	454	601	601	755	881	1,028	
144	345	531	690	690	875	1,034	1,214	

Series 8								
Length Up To	Overall Finished Width							
	42	63	84	105	126	147	168	
36	130	211	260	260	341	390	465	
48	168	254	335	335	422	477	557	
72	217	341	433	433	557	650	768	
84	254	384	508	508	638	736	860	
108	303	471	606	606	774	909	1,071	
120	341	514	681	681	855	996	1,163	
144	390	601	780	780	990	1,169	1,374	

Series 9								
Length Up To	Overall Finished Width							
	42	63	84	105	126	147	168	
36	142	231	284	284	373	426	509	
48	184	278	367	367	462	521	609	
72	237	373	473	473	609	710	840	
84	278	420	556	556	698	804	940	
108	331	515	662	662	846	993	1,171	
120	373	562	745	745	935	1,088	1,271	
144	426	657	852	852	1,082	1,277	1,502	

Series 10								
Length Up To	Overall Finished Width							
	42	63	84	105	126	147	168	
36	154	251	308	308	405	462	553	
48	200	302	399	399	502	565	661	
72	257	405	513	513	661	770	912	
84	302	456	604	604	758	872	1,020	
108	359	559	718	718	918	1,077	1,271	
120	405	610	809	809	1,015	1,180	1,379	
144	462	713	924	924	1,174	1,385	1,630	

Series 11								
Length Up To	Overall Finished Width							
	42	63	84	105	126	147	168	
36	166	271	332	332	437	498	597	
48	216	326	431	431	542	609	713	
72	277	437	553	553	713	830	984	
84	326	492	652	652	818	940	1,100	
108	387	603	774	774	990	1,161	1,371	
120	437	658	873	873	1,095	1,272	1,487	
144	498	769	996	996	1,266	1,493	1,758	

Series 12								
Length Up To	Overall Finished Width							
	42	63	84	105	126	147	168	
36	178	291	356	356	469	534	641	
48	232	350	463	463	582	653	765	
72	297	469	593	593	765	890	1,056	
84	350	528	700	700	878	1,008	1,180	
108	415	647	830	830	1,062	1,245	1,471	
120	469	706	937	937	1,175	1,364	1,595	
144	534	825	1,068	1,068	1,358	1,601	1,886	

Series 13								
Length Up To	Overall Finished Width							
	42	63	84	105	126	147	168	
36	190	311	380	380	501	570	685	
48	248	374	495	495	622	697	817	
72	317	501	633	633	817	950	1,128	
84	374	564	748	748	938	1,076	1,260	
108	443	691	886	886	1,134	1,329	1,571	
120	501	754	1,001	1,001	1,255	1,456	1,703	
144	570	881	1,140	1,140	1,450	1,709	2,014	

Series 14								
Length Up To	Overall Finished Width							
	42	63	84	105	126	147	168	
36	202	331	404	404	533	606	729	
48	264	398	527	527	662	741	869	
72	337	533	673	673	869	1,010	1,200	
84	398	600	796	796	998	1,144	1,340	
108	471	735	942	942	1,206	1,413	1,671	
120	533	802	1,065	1,065	1,335	1,548	1,811	
144	606	937	1,212	1,212	1,542	1,817	2,142	

Series 15								
Length Up To	Overall Finished Width							
	42	63	84	105	126	147	168	
36	214	351	428	428	565	642	773	
48	280	422	559	559	702	785	921	
72	357	565	713	713	921	1,070	1,272	
84	422	636	844	844	1,058	1,212	1,420	
108	499	779	998	998	1,278	1,497	1,771	
120	565	850	1,129	1,129	1,415	1,640	1,919	
144	642	993	1,284	1,284	1,634	1,925	2,270	

Series 16								
Length Up To	Overall Finished Width							
	42	63	84	105	126	147	168	
36	226	371	452	452	597	678	817	
48	296	446	591	591	742	829	973	
72	377	597	753	753	973	1,130	1,344	
84	446	672	892	892	1,118	1,280	1,500	
108	527	823	1,054	1,054	1,350	1,581	1,871	
120	597	898	1,193	1,193	1,495	1,732	2,027	
144	678	1,049	1,356	1,356	1,726	2,033	2,398	

ROD POCKET DRAPERIES: 2 Fullness — Unlined

Chart pricing for rod pocket single or double. Sizes and series numbers beyond what is listed in the charts below are available—please submit these quote requests via fax or email.

Number of Widths						
2	3	4	4	5	6	7

Number of Widths						
2	3	4	4	5	6	7

Series 17

Length Up To	Overall Finished Width						
	42	63	84	105	126	147	168
36	238	391	476	476	629	714	861
48	312	470	623	623	782	873	1,025
72	397	629	793	793	1,025	1,190	1,416
84	470	708	940	940	1,178	1,348	1,580
108	555	867	1,110	1,110	1,422	1,665	1,971
120	629	946	1,257	1,257	1,575	1,824	2,135
144	714	1,105	1,428	1,428	1,818	2,141	2,526

Series 18

Length Up To	Overall Finished Width						
	42	63	84	105	126	147	168
36	250	411	500	500	661	750	905
48	328	494	655	655	822	917	1,077
72	417	661	833	833	1,077	1,250	1,488
84	494	744	988	988	1,238	1,416	1,660
108	583	911	1,166	1,166	1,494	1,749	2,071
120	661	994	1,321	1,321	1,655	1,916	2,243
144	750	1,161	1,500	1,500	1,910	2,249	2,654

Series 19

Length Up To	Overall Finished Width						
	42	63	84	105	126	147	168
36	262	431	524	524	693	786	949
48	344	518	687	687	862	961	1,129
72	437	693	873	873	1,129	1,310	1,560
84	518	780	1,036	1,036	1,298	1,484	1,740
108	611	955	1,222	1,222	1,566	1,833	2,171
120	693	1,042	1,385	1,385	1,735	2,008	2,351
144	786	1,217	1,572	1,572	2,002	2,357	2,782

Series 20

Length Up To	Overall Finished Width						
	42	63	84	105	126	147	168
36	274	451	548	548	725	822	993
48	360	542	719	719	902	1,005	1,181
72	457	725	913	913	1,181	1,370	1,632
84	542	816	1,084	1,084	1,358	1,552	1,820
108	639	999	1,278	1,278	1,638	1,917	2,271
120	725	1,090	1,449	1,449	1,815	2,100	2,459
144	822	1,273	1,644	1,644	2,094	2,465	2,910

Series 21

Length Up To	Overall Finished Width						
	42	63	84	105	126	147	168
36	286	471	572	572	757	858	1,037
48	376	566	751	751	942	1,049	1,233
72	477	757	953	953	1,233	1,430	1,704
84	566	852	1,132	1,132	1,418	1,620	1,900
108	667	1,043	1,334	1,334	1,710	2,001	2,371
120	757	1,138	1,513	1,513	1,895	2,192	2,567
144	858	1,329	1,716	1,716	2,186	2,573	3,038

Series 22

Length Up To	Overall Finished Width						
	42	63	84	105	126	147	168
36	298	491	596	596	789	894	1,081
48	392	590	783	783	982	1,093	1,285
72	497	789	993	993	1,285	1,490	1,776
84	590	888	1,180	1,180	1,478	1,688	1,980
108	695	1,087	1,390	1,390	1,782	2,085	2,471
120	789	1,186	1,577	1,577	1,975	2,284	2,675
144	894	1,385	1,788	1,788	2,278	2,681	3,166

Series 23

Length Up To	Overall Finished Width						
	42	63	84	105	126	147	168
36	310	511	620	620	821	930	1,125
48	408	614	815	815	1,022	1,137	1,337
72	517	821	1,033	1,033	1,337	1,550	1,848
84	614	924	1,228	1,228	1,538	1,756	2,060
108	723	1,131	1,446	1,446	1,854	2,169	2,571
120	821	1,234	1,641	1,641	2,055	2,376	2,783
144	930	1,441	1,860	1,860	2,370	2,789	3,294

Series 24

Length Up To	Overall Finished Width						
	42	63	84	105	126	147	168
36	322	531	644	644	853	966	1,169
48	424	638	847	847	1,062	1,181	1,389
72	537	853	1,073	1,073	1,389	1,610	1,920
84	638	960	1,276	1,276	1,598	1,824	2,140
108	751	1,175	1,502	1,502	1,926	2,253	2,671
120	853	1,282	1,705	1,705	2,135	2,468	2,891
144	966	1,497	1,932	1,932	2,462	2,897	3,422

Series 25

Length Up To	Overall Finished Width						
	42	63	84	105	126	147	168
36	340	561	680	680	901	1,020	1,235
48	448	674	895	895	1,122	1,247	1,467
72	567	901	1,133	1,133	1,467	1,700	2,028
84	674	1,014	1,348	1,348	1,688	1,926	2,260
108	793	1,241	1,586	1,586	2,034	2,379	2,821
120	901	1,354	1,801	1,801	2,255	2,606	3,053
144	1,020	1,581	2,040	2,040	2,600	3,059	3,614

Series 26

Length Up To	Overall Finished Width						
	42	63	84	105	126	147	168
36	352	581	704	704	933	1,056	1,279
48	464	698	927	927	1,162	1,291	1,519
72	587	933	1,173	1,173	1,519	1,760	2,100
84	698	1,050	1,396	1,396	1,748	1,994	2,340
108	821	1,285	1,642	1,642	2,106	2,463	2,921
120	933	1,402	1,865	1,865	2,335	2,698	3,161
144	1,056	1,637	2,112	2,112	2,692	3,167	3,742

ROD POCKET DRAPERIES: 2 Fullness — Lined (Lining 01000)

Chart pricing for rod pocket single or double. Sizes and series numbers beyond what is listed in the charts below are available—please submit these quote requests via fax or email.

Number of Widths							
2	3	4	4	5	6	7	

Number of Widths							
2	3	4	4	5	6	7	

Series 7

Length Up To	Overall Finished Width						
	42	63	84	105	126	147	168
36	215	320	414	444	549	643	742
48	249	362	483	513	625	725	831
60	284	403	531	561	680	808	921
72	297	444	579	609	756	891	1,031
84	332	486	648	678	832	973	1,121
96	366	527	696	726	887	1,056	1,210
101	373	534	731	761	921	1,091	1,251

Series 8

Length Up To	Overall Finished Width						
	42	63	84	105	126	147	168
36	230	345	444	474	589	688	797
48	269	392	523	553	675	780	896
60	309	438	576	606	735	873	996
72	322	484	629	659	821	966	1,121
84	362	531	708	738	907	1,058	1,221
96	401	577	761	791	967	1,151	1,320
101	408	584	801	831	1,006	1,191	1,366

Series 9

Length Up To	Overall Finished Width						
	42	63	84	105	126	147	168
36	242	365	468	498	621	724	841
48	285	416	555	585	715	824	948
60	329	466	612	642	779	925	1,056
72	342	516	669	699	873	1,026	1,193
84	386	567	756	786	967	1,126	1,301
96	429	617	813	843	1,031	1,227	1,408
101	436	624	857	887	1,074	1,271	1,458

Series 10

Length Up To	Overall Finished Width						
	42	63	84	105	126	147	168
36	254	385	492	522	653	760	885
48	301	440	587	617	755	868	1,000
60	349	494	648	678	823	977	1,116
72	362	548	709	739	925	1,086	1,265
84	410	603	804	834	1,027	1,194	1,381
96	457	657	865	895	1,095	1,303	1,496
101	464	664	913	943	1,142	1,351	1,550

Series 11

Length Up To	Overall Finished Width						
	42	63	84	105	126	147	168
36	266	405	516	546	685	796	929
48	317	464	619	649	795	912	1,052
60	369	522	684	714	867	1,029	1,176
72	382	580	749	779	977	1,146	1,337
84	434	639	852	882	1,087	1,262	1,461
96	485	697	917	947	1,159	1,379	1,584
101	492	704	969	999	1,210	1,431	1,642

Series 12

Length Up To	Overall Finished Width						
	42	63	84	105	126	147	168
36	278	425	540	570	717	832	973
48	333	488	651	681	835	956	1,104
60	389	550	720	750	911	1,081	1,236
72	402	612	789	819	1,029	1,206	1,409
84	458	675	900	930	1,147	1,330	1,541
96	513	737	969	999	1,223	1,455	1,672
101	520	744	1,025	1,055	1,278	1,511	1,734

Series 13

Length Up To	Overall Finished Width						
	42	63	84	105	126	147	168
36	290	445	564	594	749	868	1,017
48	349	512	683	713	875	1,000	1,156
60	409	578	756	786	955	1,133	1,296
72	422	644	829	859	1,081	1,266	1,481
84	482	711	948	978	1,207	1,398	1,621
96	541	777	1,021	1,051	1,287	1,531	1,760
101	548	784	1,081	1,111	1,346	1,591	1,826

Series 14

Length Up To	Overall Finished Width						
	42	63	84	105	126	147	168
36	302	465	588	618	781	904	1,061
48	365	536	715	745	915	1,044	1,208
60	429	606	792	822	999	1,185	1,356
72	442	676	869	899	1,133	1,326	1,553
84	506	747	996	1,026	1,267	1,466	1,701
96	569	817	1,073	1,103	1,351	1,607	1,848
101	576	824	1,137	1,167	1,414	1,671	1,918

Series 15

Length Up To	Overall Finished Width						
	42	63	84	105	126	147	168
36	314	485	612	642	813	940	1,105
48	381	560	747	777	955	1,088	1,260
60	449	634	828	858	1,043	1,237	1,416
72	462	708	909	939	1,185	1,386	1,625
84	530	783	1,044	1,074	1,327	1,534	1,781
96	597	857	1,125	1,155	1,415	1,683	1,936
101	604	864	1,193	1,223	1,482	1,751	2,010

Series 16

Length Up To	Overall Finished Width						
	42	63	84	105	126	147	168
36	326	505	636	666	845	976	1,149
48	397	584	779	809	995	1,132	1,312
60	469	662	864	894	1,087	1,289	1,476
72	482	740	949	979	1,237	1,446	1,697
84	554	819	1,092	1,122	1,387	1,602	1,861
96	625	897	1,177	1,207	1,479	1,759	2,024
101	632	904	1,249	1,279	1,550	1,831	2,102

ROD POCKET DRAPERIES: 2 Fullness — Lined (Lining 01000)

Chart pricing for rod pocket single or double. Sizes and series numbers beyond what is listed in the charts below are available—please submit these quote requests via fax or email.

Number of Widths						
2	3	4	4	5	6	7

Number of Widths						
2	3	4	4	5	6	7

Series 17

Length Up To	Overall Finished Width						
	42	63	84	105	126	147	168
36	338	525	660	690	877	1,012	1,193
48	413	608	811	841	1,035	1,176	1,364
60	489	690	900	930	1,131	1,341	1,536
72	502	772	989	1,019	1,289	1,506	1,769
84	578	855	1,140	1,170	1,447	1,670	1,941
96	653	937	1,229	1,259	1,543	1,835	2,112
101	660	944	1,305	1,335	1,618	1,911	2,194

Series 18

Length Up To	Overall Finished Width						
	42	63	84	105	126	147	168
36	350	545	684	714	909	1,048	1,237
48	429	632	843	873	1,075	1,220	1,416
60	509	718	936	966	1,175	1,393	1,596
72	522	804	1,029	1,059	1,341	1,566	1,841
84	602	891	1,188	1,218	1,507	1,738	2,021
96	681	977	1,281	1,311	1,607	1,911	2,200
101	688	984	1,361	1,391	1,686	1,991	2,286

Series 19

Length Up To	Overall Finished Width						
	42	63	84	105	126	147	168
36	362	565	708	738	941	1,084	1,281
48	445	656	875	905	1,115	1,264	1,468
60	529	746	972	1,002	1,219	1,445	1,656
72	542	836	1,069	1,099	1,393	1,626	1,913
84	626	927	1,236	1,266	1,567	1,806	2,101
96	709	1,017	1,333	1,363	1,671	1,987	2,288
101	716	1,024	1,417	1,447	1,754	2,071	2,378

Series 20

Length Up To	Overall Finished Width						
	42	63	84	105	126	147	168
36	374	585	732	762	973	1,120	1,325
48	461	680	907	937	1,155	1,308	1,520
60	549	774	1,008	1,038	1,263	1,497	1,716
72	562	868	1,109	1,139	1,445	1,686	1,985
84	650	963	1,284	1,314	1,627	1,874	2,181
96	737	1,057	1,385	1,415	1,735	2,063	2,376
101	744	1,064	1,473	1,503	1,822	2,151	2,470

Series 21

Length Up To	Overall Finished Width						
	42	63	84	105	126	147	168
36	386	605	756	786	1,005	1,156	1,369
48	477	704	939	969	1,195	1,352	1,572
60	569	802	1,044	1,074	1,307	1,549	1,776
72	582	900	1,149	1,179	1,497	1,746	2,057
84	674	999	1,332	1,362	1,687	1,942	2,261
96	765	1,097	1,437	1,467	1,799	2,139	2,464
101	772	1,104	1,529	1,559	1,890	2,231	2,562

Series 22

Length Up To	Overall Finished Width						
	42	63	84	105	126	147	168
36	398	625	780	810	1,037	1,192	1,413
48	493	728	971	1,001	1,235	1,396	1,624
60	589	830	1,080	1,110	1,351	1,601	1,836
72	602	932	1,189	1,219	1,549	1,806	2,129
84	698	1,035	1,380	1,410	1,747	2,010	2,341
96	793	1,137	1,489	1,519	1,863	2,215	2,552
101	800	1,144	1,585	1,615	1,958	2,311	2,654

Series 23

Length Up To	Overall Finished Width						
	42	63	84	105	126	147	168
36	410	645	804	834	1,069	1,228	1,457
48	509	752	1,003	1,033	1,275	1,440	1,676
60	609	858	1,116	1,146	1,395	1,653	1,896
72	622	964	1,229	1,259	1,601	1,866	2,201
84	722	1,071	1,428	1,458	1,807	2,078	2,421
96	821	1,177	1,541	1,571	1,927	2,291	2,640
101	828	1,184	1,641	1,671	2,026	2,391	2,746

Series 24

Length Up To	Overall Finished Width						
	42	63	84	105	126	147	168
36	422	665	828	858	1,101	1,264	1,501
48	525	776	1,035	1,065	1,315	1,484	1,728
60	629	886	1,152	1,182	1,439	1,705	1,956
72	642	996	1,269	1,299	1,653	1,926	2,273
84	746	1,107	1,476	1,506	1,867	2,146	2,501
96	849	1,217	1,593	1,623	1,991	2,367	2,728
101	856	1,224	1,697	1,727	2,094	2,471	2,838

Series 25

Length Up To	Overall Finished Width						
	42	63	84	105	126	147	168
36	440	695	864	894	1,149	1,318	1,567
48	549	812	1,083	1,113	1,375	1,550	1,806
60	659	928	1,206	1,236	1,505	1,783	2,046
72	672	1,044	1,329	1,359	1,731	2,016	2,381
84	782	1,161	1,548	1,578	1,957	2,248	2,621
96	891	1,277	1,671	1,701	2,087	2,481	2,860
101	898	1,284	1,781	1,811	2,196	2,591	2,976

Series 26

Length Up To	Overall Finished Width						
	42	63	84	105	126	147	168
36	452	715	888	918	1,181	1,354	1,611
48	565	836	1,115	1,145	1,415	1,594	1,858
60	679	956	1,242	1,272	1,549	1,835	2,106
72	692	1,076	1,369	1,399	1,783	2,076	2,453
84	806	1,197	1,596	1,626	2,017	2,316	2,701
96	919	1,317	1,723	1,753	2,151	2,557	2,948
101	926	1,324	1,837	1,867	2,264	2,671	3,068

ROD POCKET DRAPERIES: 2.5 Fullness — Unlined

Chart pricing for rod pocket single or double. Sizes and series numbers beyond what is listed in the charts below are available—please submit these quote requests via fax or email.

Number of Widths							
2	3	4	5	6	7	8	

Number of Widths							
2	3	4	5	6	7	8	

Series 7								
Length Up To	Overall Finished Width							
	42	63	84	105	126	147	168	
36	115	186	230	301	345	410	460	
48	148	224	295	372	422	492	569	
72	192	301	383	492	575	678	766	
84	224	339	448	563	651	760	875	
108	268	416	536	684	804	946	1,072	
120	301	454	601	755	881	1,028	1,181	
144	345	531	690	875	1,034	1,214	1,379	

Series 8								
Length Up To	Overall Finished Width							
	42	63	84	105	126	147	168	
36	130	211	260	341	390	465	520	
48	168	254	335	422	477	557	644	
72	217	341	433	557	650	768	866	
84	254	384	508	638	736	860	990	
108	303	471	606	774	909	1,071	1,212	
120	341	514	681	855	996	1,163	1,336	
144	390	601	780	990	1,169	1,374	1,559	

Series 9								
Length Up To	Overall Finished Width							
	42	63	84	105	126	147	168	
36	142	231	284	373	426	509	568	
48	184	278	367	462	521	609	704	
72	237	373	473	609	710	840	946	
84	278	420	556	698	804	940	1,082	
108	331	515	662	846	993	1,171	1,324	
120	373	562	745	935	1,088	1,271	1,460	
144	426	657	852	1,082	1,277	1,502	1,703	

Series 10								
Length Up To	Overall Finished Width							
	42	63	84	105	126	147	168	
36	154	251	308	405	462	553	616	
48	200	302	399	502	565	661	764	
72	257	405	513	661	770	912	1,026	
84	302	456	604	758	872	1,020	1,174	
108	359	559	718	918	1,077	1,271	1,436	
120	405	610	809	1,015	1,180	1,379	1,584	
144	462	713	924	1,174	1,385	1,630	1,847	

Series 11								
Length Up To	Overall Finished Width							
	42	63	84	105	126	147	168	
36	166	271	332	437	498	597	664	
48	216	326	431	542	609	713	824	
72	277	437	553	713	830	984	1,106	
84	326	492	652	818	940	1,100	1,266	
108	387	603	774	990	1,161	1,371	1,548	
120	437	658	873	1,095	1,272	1,487	1,708	
144	498	769	996	1,266	1,493	1,758	1,991	

Series 12								
Length Up To	Overall Finished Width							
	42	63	84	105	126	147	168	
36	178	291	356	469	534	641	712	
48	232	350	463	582	653	765	884	
72	297	469	593	765	890	1,056	1,186	
84	350	528	700	878	1,008	1,180	1,358	
108	415	647	830	1,062	1,245	1,471	1,660	
120	469	706	937	1,175	1,364	1,595	1,832	
144	534	825	1,068	1,358	1,601	1,886	2,135	

Series 13								
Length Up To	Overall Finished Width							
	42	63	84	105	126	147	168	
36	190	311	380	501	570	685	760	
48	248	374	495	622	697	817	944	
72	317	501	633	817	950	1,128	1,266	
84	374	564	748	938	1,076	1,260	1,450	
108	443	691	886	1,134	1,329	1,571	1,772	
120	501	754	1,001	1,255	1,456	1,703	1,956	
144	570	881	1,140	1,450	1,709	2,014	2,279	

Series 14								
Length Up To	Overall Finished Width							
	42	63	84	105	126	147	168	
36	202	331	404	533	606	729	808	
48	264	398	527	662	741	869	1,004	
72	337	533	673	869	1,010	1,200	1,346	
84	398	600	796	998	1,144	1,340	1,542	
108	471	735	942	1,206	1,413	1,671	1,884	
120	533	802	1,065	1,335	1,548	1,811	2,080	
144	606	937	1,212	1,542	1,817	2,142	2,423	

Series 15								
Length Up To	Overall Finished Width							
	42	63	84	105	126	147	168	
36	214	351	428	565	642	773	856	
48	280	422	559	702	785	921	1,064	
72	357	565	713	921	1,070	1,272	1,426	
84	422	636	844	1,058	1,212	1,420	1,634	
108	499	779	998	1,278	1,497	1,771	1,996	
120	565	850	1,129	1,415	1,640	1,919	2,204	
144	642	993	1,284	1,634	1,925	2,270	2,567	

Series 16								
Length Up To	Overall Finished Width							
	42	63	84	105	126	147	168	
36	226	371	452	597	678	817	904	
48	296	446	591	742	829	973	1,124	
72	377	597	753	973	1,130	1,344	1,506	
84	446	672	892	1,118	1,280	1,500	1,726	
108	527	823	1,054	1,350	1,581	1,871	2,108	
120	597	898	1,193	1,495	1,732	2,027	2,328	
144	678	1,049	1,356	1,726	2,033	2,398	2,711	

ROD POCKET DRAPERIES: 2.5 Fullness — Unlined

Chart pricing for rod pocket single or double. Sizes and series numbers beyond what is listed in the charts below are available—please submit these quote requests via fax or email.

Number of Widths							
2	3	4	5	6	7	8	

Number of Widths							
2	3	4	5	6	7	8	

Series 17

Length Up To	Overall Finished Width						
	42	63	84	105	126	147	168
36	238	391	476	629	714	861	952
48	312	470	623	782	873	1,025	1,184
72	397	629	793	1,025	1,190	1,416	1,586
84	470	708	940	1,178	1,348	1,580	1,818
108	555	867	1,110	1,422	1,665	1,971	2,220
120	629	946	1,257	1,575	1,824	2,135	2,452
144	714	1,105	1,428	1,818	2,141	2,526	2,855

Series 18

Length Up To	Overall Finished Width						
	42	63	84	105	126	147	168
36	250	411	500	661	750	905	1,000
48	328	494	655	822	917	1,077	1,244
72	417	661	833	1,077	1,250	1,488	1,666
84	494	744	988	1,238	1,416	1,660	1,910
108	583	911	1,166	1,494	1,749	2,071	2,332
120	661	994	1,321	1,655	1,916	2,243	2,576
144	750	1,161	1,500	1,910	2,249	2,654	2,999

Series 19

Length Up To	Overall Finished Width						
	42	63	84	105	126	147	168
36	262	431	524	693	786	949	1,048
48	344	518	687	862	961	1,129	1,304
72	437	693	873	1,129	1,310	1,560	1,746
84	518	780	1,036	1,298	1,484	1,740	2,002
108	611	955	1,222	1,566	1,833	2,171	2,444
120	693	1,042	1,385	1,735	2,008	2,351	2,700
144	786	1,217	1,572	2,002	2,357	2,782	3,143

Series 20

Length Up To	Overall Finished Width						
	42	63	84	105	126	147	168
36	274	451	548	725	822	993	1,096
48	360	542	719	902	1,005	1,181	1,364
72	457	725	913	1,181	1,370	1,632	1,826
84	542	816	1,084	1,358	1,552	1,820	2,094
108	639	999	1,278	1,638	1,917	2,271	2,556
120	725	1,090	1,449	1,815	2,100	2,459	2,824
144	822	1,273	1,644	2,094	2,465	2,910	3,287

Series 21

Length Up To	Overall Finished Width						
	42	63	84	105	126	147	168
36	286	471	572	757	858	1,037	1,144
48	376	566	751	942	1,049	1,233	1,424
72	477	757	953	1,233	1,430	1,704	1,906
84	566	852	1,132	1,418	1,620	1,900	2,186
108	667	1,043	1,334	1,710	2,001	2,371	2,668
120	757	1,138	1,513	1,895	2,192	2,567	2,948
144	858	1,329	1,716	2,186	2,573	3,038	3,431

Series 22

Length Up To	Overall Finished Width						
	42	63	84	105	126	147	168
36	298	491	596	789	894	1,081	1,192
48	392	590	783	982	1,093	1,285	1,484
72	497	789	993	1,285	1,490	1,776	1,986
84	590	888	1,180	1,478	1,688	1,980	2,278
108	695	1,087	1,390	1,782	2,085	2,471	2,780
120	789	1,186	1,577	1,975	2,284	2,675	3,072
144	894	1,385	1,788	2,278	2,681	3,166	3,575

Series 23

Length Up To	Overall Finished Width						
	42	63	84	105	126	147	168
36	310	511	620	821	930	1,125	1,240
48	408	614	815	1,022	1,137	1,337	1,544
72	517	821	1,033	1,337	1,550	1,848	2,066
84	614	924	1,228	1,538	1,756	2,060	2,370
108	723	1,131	1,446	1,854	2,169	2,571	2,892
120	821	1,234	1,641	2,055	2,376	2,783	3,196
144	930	1,441	1,860	2,370	2,789	3,294	3,719

Series 24

Length Up To	Overall Finished Width						
	42	63	84	105	126	147	168
36	322	531	644	853	966	1,169	1,288
48	424	638	847	1,062	1,181	1,389	1,604
72	537	853	1,073	1,389	1,610	1,920	2,146
84	638	960	1,276	1,598	1,824	2,140	2,462
108	751	1,175	1,502	1,926	2,253	2,671	3,004
120	853	1,282	1,705	2,135	2,468	2,891	3,320
144	966	1,497	1,932	2,462	2,897	3,422	3,863

Series 25

Length Up To	Overall Finished Width						
	42	63	84	105	126	147	168
36	340	561	680	901	1,020	1,235	1,360
48	448	674	895	1,122	1,247	1,467	1,694
72	567	901	1,133	1,467	1,700	2,028	2,266
84	674	1,014	1,348	1,688	1,926	2,260	2,600
108	793	1,241	1,586	2,034	2,379	2,821	3,172
120	901	1,354	1,801	2,255	2,606	3,053	3,506
144	1,020	1,581	2,040	2,600	3,059	3,614	4,079

Series 26

Length Up To	Overall Finished Width						
	42	63	84	105	126	147	168
36	352	581	704	933	1,056	1,279	1,408
48	464	698	927	1,162	1,291	1,519	1,754
72	587	933	1,173	1,519	1,760	2,100	2,346
84	698	1,050	1,396	1,748	1,994	2,340	2,692
108	821	1,285	1,642	2,106	2,463	2,921	3,284
120	933	1,402	1,865	2,335	2,698	3,161	3,630
144	1,056	1,637	2,112	2,692	3,167	3,742	4,223

ROD POCKET DRAPERIES: 2.5 Fullness — Lined (Lining 01000)

Chart pricing for rod pocket single or double. Sizes and series numbers beyond what is listed in the charts below are available—please submit these quote requests via fax or email.

Number of Widths							
2	3	4	5	6	7	8	

Number of Widths							
2	3	4	5	6	7	8	

Series 7								
Length Up To	Overall Finished Width							
	42	63	84	105	126	147	168	
36	230	350	444	564	658	772	872	
48	264	392	513	640	740	861	989	
60	299	433	561	695	823	951	1,106	
72	312	474	609	771	906	1,061	1,202	
84	347	516	678	847	988	1,151	1,320	
96	381	557	726	902	1,071	1,240	1,437	
101	388	564	761	936	1,106	1,281	1,478	

Series 8								
Length Up To	Overall Finished Width							
	42	63	84	105	126	147	168	
36	245	375	474	604	703	827	932	
48	284	422	553	690	795	926	1,064	
60	324	468	606	750	888	1,026	1,196	
72	337	514	659	836	981	1,151	1,302	
84	377	561	738	922	1,073	1,251	1,435	
96	416	607	791	982	1,166	1,350	1,567	
101	423	614	831	1,021	1,206	1,396	1,613	

Series 9								
Length Up To	Overall Finished Width							
	42	63	84	105	126	147	168	
36	257	395	498	636	739	871	980	
48	300	446	585	730	839	978	1,124	
60	344	496	642	794	940	1,086	1,268	
72	357	546	699	888	1,041	1,223	1,382	
84	401	597	786	982	1,141	1,331	1,527	
96	444	647	843	1,046	1,242	1,438	1,671	
101	451	654	887	1,089	1,286	1,488	1,721	

Series 10								
Length Up To	Overall Finished Width							
	42	63	84	105	126	147	168	
36	269	415	522	668	775	915	1,028	
48	316	470	617	770	883	1,030	1,184	
60	364	524	678	838	992	1,146	1,340	
72	377	578	739	940	1,101	1,295	1,462	
84	425	633	834	1,042	1,209	1,411	1,619	
96	472	687	895	1,110	1,318	1,526	1,775	
101	479	694	943	1,157	1,366	1,580	1,829	

Series 11								
Length Up To	Overall Finished Width							
	42	63	84	105	126	147	168	
36	281	435	546	700	811	959	1,076	
48	332	494	649	810	927	1,082	1,244	
60	384	552	714	882	1,044	1,206	1,412	
72	397	610	779	992	1,161	1,367	1,542	
84	449	669	882	1,102	1,277	1,491	1,711	
96	500	727	947	1,174	1,394	1,614	1,879	
101	507	734	999	1,225	1,446	1,672	1,937	

Series 12								
Length Up To	Overall Finished Width							
	42	63	84	105	126	147	168	
36	293	455	570	732	847	1,003	1,124	
48	348	518	681	850	971	1,134	1,304	
60	404	580	750	926	1,096	1,266	1,484	
72	417	642	819	1,044	1,221	1,439	1,622	
84	473	705	930	1,162	1,345	1,571	1,803	
96	528	767	999	1,238	1,470	1,702	1,983	
101	535	774	1,055	1,293	1,526	1,764	2,045	

Series 13								
Length Up To	Overall Finished Width							
	42	63	84	105	126	147	168	
36	305	475	594	764	883	1,047	1,172	
48	364	542	713	890	1,015	1,186	1,364	
60	424	608	786	970	1,148	1,326	1,556	
72	437	674	859	1,096	1,281	1,511	1,702	
84	497	741	978	1,222	1,413	1,651	1,895	
96	556	807	1,051	1,302	1,546	1,790	2,087	
101	563	814	1,111	1,361	1,606	1,856	2,153	

Series 14								
Length Up To	Overall Finished Width							
	42	63	84	105	126	147	168	
36	317	495	618	796	919	1,091	1,220	
48	380	566	745	930	1,059	1,238	1,424	
60	444	636	822	1,014	1,200	1,386	1,628	
72	457	706	899	1,148	1,341	1,583	1,782	
84	521	777	1,026	1,282	1,481	1,731	1,987	
96	584	847	1,103	1,366	1,622	1,878	2,191	
101	591	854	1,167	1,429	1,686	1,948	2,261	

Series 15								
Length Up To	Overall Finished Width							
	42	63	84	105	126	147	168	
36	329	515	642	828	955	1,135	1,268	
48	396	590	777	970	1,103	1,290	1,484	
60	464	664	858	1,058	1,252	1,446	1,700	
72	477	738	939	1,200	1,401	1,655	1,862	
84	545	813	1,074	1,342	1,549	1,811	2,079	
96	612	887	1,155	1,430	1,698	1,966	2,295	
101	619	894	1,223	1,497	1,766	2,040	2,369	

Series 16								
Length Up To	Overall Finished Width							
	42	63	84	105	126	147	168	
36	341	535	666	860	991	1,179	1,316	
48	412	614	809	1,010	1,147	1,342	1,544	
60	484	692	894	1,102	1,304	1,506	1,772	
72	497	770	979	1,252	1,461	1,727	1,942	
84	569	849	1,122	1,402	1,617	1,891	2,171	
96	640	927	1,207	1,494	1,774	2,054	2,399	
101	647	934	1,279	1,565	1,846	2,132	2,477	

ROD POCKET DRAPERIES: 2.5 Fullness — Lined (Lining 01000)

Chart pricing for rod pocket single or double. Sizes and series numbers beyond what is listed in the charts below are available—please submit these quote requests via fax or email.

Number of Widths							
2	3	4	5	6	7	8	

Number of Widths							
2	3	4	5	6	7	8	

Series 17

Length Up To	Overall Finished Width						
	42	63	84	105	126	147	168
36	353	555	690	892	1,027	1,223	1,364
48	428	638	841	1,050	1,191	1,394	1,604
60	504	720	930	1,146	1,356	1,566	1,844
72	517	802	1,019	1,304	1,521	1,799	2,022
84	593	885	1,170	1,462	1,685	1,971	2,263
96	668	967	1,259	1,558	1,850	2,142	2,503
101	675	974	1,335	1,633	1,926	2,224	2,585

Series 18

Length Up To	Overall Finished Width						
	42	63	84	105	126	147	168
36	365	575	714	924	1,063	1,267	1,412
48	444	662	873	1,090	1,235	1,446	1,664
60	524	748	966	1,190	1,408	1,626	1,916
72	537	834	1,059	1,356	1,581	1,871	2,102
84	617	921	1,218	1,522	1,753	2,051	2,355
96	696	1,007	1,311	1,622	1,926	2,230	2,607
101	703	1,014	1,391	1,701	2,006	2,316	2,693

Series 19

Length Up To	Overall Finished Width						
	42	63	84	105	126	147	168
36	377	595	738	956	1,099	1,311	1,460
48	460	686	905	1,130	1,279	1,498	1,724
60	544	776	1,002	1,234	1,460	1,686	1,988
72	557	866	1,099	1,408	1,641	1,943	2,182
84	641	957	1,266	1,582	1,821	2,131	2,447
96	724	1,047	1,363	1,686	2,002	2,318	2,711
101	731	1,054	1,447	1,769	2,086	2,408	2,801

Series 20

Length Up To	Overall Finished Width						
	42	63	84	105	126	147	168
36	389	615	762	988	1,135	1,355	1,508
48	476	710	937	1,170	1,323	1,550	1,784
60	564	804	1,038	1,278	1,512	1,746	2,060
72	577	898	1,139	1,460	1,701	2,015	2,262
84	665	993	1,314	1,642	1,889	2,211	2,539
96	752	1,087	1,415	1,750	2,078	2,406	2,815
101	759	1,094	1,503	1,837	2,166	2,500	2,909

Series 21

Length Up To	Overall Finished Width						
	42	63	84	105	126	147	168
36	401	635	786	1,020	1,171	1,399	1,556
48	492	734	969	1,210	1,367	1,602	1,844
60	584	832	1,074	1,322	1,564	1,806	2,132
72	597	930	1,179	1,512	1,761	2,087	2,342
84	689	1,029	1,362	1,702	1,957	2,291	2,631
96	780	1,127	1,467	1,814	2,154	2,494	2,919
101	787	1,134	1,559	1,905	2,246	2,592	3,017

Series 22

Length Up To	Overall Finished Width						
	42	63	84	105	126	147	168
36	413	655	810	1,052	1,207	1,443	1,604
48	508	758	1,001	1,250	1,411	1,654	1,904
60	604	860	1,110	1,366	1,616	1,866	2,204
72	617	962	1,219	1,564	1,821	2,159	2,422
84	713	1,065	1,410	1,762	2,025	2,371	2,723
96	808	1,167	1,519	1,878	2,230	2,582	3,023
101	815	1,174	1,615	1,973	2,326	2,684	3,125

Series 23

Length Up To	Overall Finished Width						
	42	63	84	105	126	147	168
36	425	675	834	1,084	1,243	1,487	1,652
48	524	782	1,033	1,290	1,455	1,706	1,964
60	624	888	1,146	1,410	1,668	1,926	2,276
72	637	994	1,259	1,616	1,881	2,231	2,502
84	737	1,101	1,458	1,822	2,093	2,451	2,815
96	836	1,207	1,571	1,942	2,306	2,670	3,127
101	843	1,214	1,671	2,041	2,406	2,776	3,233

Series 24

Length Up To	Overall Finished Width						
	42	63	84	105	126	147	168
36	437	695	858	1,116	1,279	1,531	1,700
48	540	806	1,065	1,330	1,499	1,758	2,024
60	644	916	1,182	1,454	1,720	1,986	2,348
72	657	1,026	1,299	1,668	1,941	2,303	2,582
84	761	1,137	1,506	1,882	2,161	2,531	2,907
96	864	1,247	1,623	2,006	2,382	2,758	3,231
101	871	1,254	1,727	2,109	2,486	2,868	3,341

Series 25

Length Up To	Overall Finished Width						
	42	63	84	105	126	147	168
36	455	725	894	1,164	1,333	1,597	1,772
48	564	842	1,113	1,390	1,565	1,836	2,114
60	674	958	1,236	1,520	1,798	2,076	2,456
72	687	1,074	1,359	1,746	2,031	2,411	2,702
84	797	1,191	1,578	1,972	2,263	2,651	3,045
96	906	1,307	1,701	2,102	2,496	2,890	3,387
101	913	1,314	1,811	2,211	2,606	3,006	3,503

Series 26

Length Up To	Overall Finished Width						
	42	63	84	105	126	147	168
36	467	745	918	1,196	1,369	1,641	1,820
48	580	866	1,145	1,430	1,609	1,888	2,174
60	694	986	1,272	1,564	1,850	2,136	2,528
72	707	1,106	1,399	1,798	2,091	2,483	2,782
84	821	1,227	1,626	2,032	2,331	2,731	3,137
96	934	1,347	1,753	2,166	2,572	2,978	3,491
101	941	1,354	1,867	2,279	2,686	3,098	3,611

ROD POCKET DRAPERIES: 3 Fullness — Unlined

Chart pricing for rod pocket single or double. Sizes and series numbers beyond what is listed in the charts below are available—please submit these quote requests via fax or email.

Number of Widths						
3	4	5	6	8	9	10

Number of Widths						
3	4	5	6	8	9	10

Series 7							
Length Up To	Overall Finished Width						
	42	63	84	105	126	147	168
36	186	230	301	345	460	525	575
48	224	295	372	422	569	640	716
72	301	383	492	575	766	869	957
84	339	448	563	651	875	984	1,099
108	416	536	684	804	1,072	1,214	1,340
120	454	601	755	881	1,181	1,329	1,482
144	531	690	875	1,034	1,379	1,558	1,723

Series 8							
Length Up To	Overall Finished Width						
	42	63	84	105	126	147	168
36	211	260	341	390	520	595	650
48	254	335	422	477	644	725	811
72	341	433	557	650	866	984	1,082
84	384	508	638	736	990	1,114	1,244
108	471	606	774	909	1,212	1,374	1,515
120	514	681	855	996	1,336	1,504	1,677
144	601	780	990	1,169	1,559	1,763	1,948

Series 9							
Length Up To	Overall Finished Width						
	42	63	84	105	126	147	168
36	231	284	373	426	568	651	710
48	278	367	462	521	704	793	887
72	373	473	609	710	946	1,076	1,182
84	420	556	698	804	1,082	1,218	1,360
108	515	662	846	993	1,324	1,502	1,655
120	562	745	935	1,088	1,460	1,644	1,833
144	657	852	1,082	1,277	1,703	1,927	2,128

Series 10							
Length Up To	Overall Finished Width						
	42	63	84	105	126	147	168
36	251	308	405	462	616	707	770
48	302	399	502	565	764	861	963
72	405	513	661	770	1,026	1,168	1,282
84	456	604	758	872	1,174	1,322	1,476
108	559	718	918	1,077	1,436	1,630	1,795
120	610	809	1,015	1,180	1,584	1,784	1,989
144	713	924	1,174	1,385	1,847	2,091	2,308

Series 11							
Length Up To	Overall Finished Width						
	42	63	84	105	126	147	168
36	271	332	437	498	664	763	830
48	326	431	542	609	824	929	1,039
72	437	553	713	830	1,106	1,260	1,382
84	492	652	818	940	1,266	1,426	1,592
108	603	774	990	1,161	1,548	1,758	1,935
120	658	873	1,095	1,272	1,708	1,924	2,145
144	769	996	1,266	1,493	1,991	2,255	2,488

Series 12							
Length Up To	Overall Finished Width						
	42	63	84	105	126	147	168
36	291	356	469	534	712	819	890
48	350	463	582	653	884	997	1,115
72	469	593	765	890	1,186	1,352	1,482
84	528	700	878	1,008	1,358	1,530	1,708
108	647	830	1,062	1,245	1,660	1,886	2,075
120	706	937	1,175	1,364	1,832	2,064	2,301
144	825	1,068	1,358	1,601	2,135	2,419	2,668

Series 13							
Length Up To	Overall Finished Width						
	42	63	84	105	126	147	168
36	311	380	501	570	760	875	950
48	374	495	622	697	944	1,065	1,191
72	501	633	817	950	1,266	1,444	1,582
84	564	748	938	1,076	1,450	1,634	1,824
108	691	886	1,134	1,329	1,772	2,014	2,215
120	754	1,001	1,255	1,456	1,956	2,204	2,457
144	881	1,140	1,450	1,709	2,279	2,583	2,848

Series 14							
Length Up To	Overall Finished Width						
	42	63	84	105	126	147	168
36	331	404	533	606	808	931	1,010
48	398	527	662	741	1,004	1,133	1,267
72	533	673	869	1,010	1,346	1,536	1,682
84	600	796	998	1,144	1,542	1,738	1,940
108	735	942	1,206	1,413	1,884	2,142	2,355
120	802	1,065	1,335	1,548	2,080	2,344	2,613
144	937	1,212	1,542	1,817	2,423	2,747	3,028

Series 15							
Length Up To	Overall Finished Width						
	42	63	84	105	126	147	168
36	351	428	565	642	856	987	1,070
48	422	559	702	785	1,064	1,201	1,343
72	565	713	921	1,070	1,426	1,628	1,782
84	636	844	1,058	1,212	1,634	1,842	2,056
108	779	998	1,278	1,497	1,996	2,270	2,495
120	850	1,129	1,415	1,640	2,204	2,484	2,769
144	993	1,284	1,634	1,925	2,567	2,911	3,208

Series 16							
Length Up To	Overall Finished Width						
	42	63	84	105	126	147	168
36	371	452	597	678	904	1,043	1,130
48	446	591	742	829	1,124	1,269	1,419
72	597	753	973	1,130	1,506	1,720	1,882
84	672	892	1,118	1,280	1,726	1,946	2,172
108	823	1,054	1,350	1,581	2,108	2,398	2,635
120	898	1,193	1,495	1,732	2,328	2,624	2,925
144	1,049	1,356	1,726	2,033	2,711	3,075	3,388

ROD POCKET DRAPERIES: 3 Fullness — Unlined

Chart pricing for rod pocket single or double. Sizes and series numbers beyond what is listed in the charts below are available—please submit these quote requests via fax or email.

Number of Widths						
3	4	5	6	8	9	10

Number of Widths						
3	4	5	6	8	9	10

Series 17

Length Up To	Overall Finished Width						
	42	63	84	105	126	147	168
36	391	476	629	714	952	1,099	1,190
48	470	623	782	873	1,184	1,337	1,495
72	629	793	1,025	1,190	1,586	1,812	1,982
84	708	940	1,178	1,348	1,818	2,050	2,288
108	867	1,110	1,422	1,665	2,220	2,526	2,775
120	946	1,257	1,575	1,824	2,452	2,764	3,081
144	1,105	1,428	1,818	2,141	2,855	3,239	3,568

Series 18

Length Up To	Overall Finished Width						
	42	63	84	105	126	147	168
36	411	500	661	750	1,000	1,155	1,250
48	494	655	822	917	1,244	1,405	1,571
72	661	833	1,077	1,250	1,666	1,904	2,082
84	744	988	1,238	1,416	1,910	2,154	2,404
108	911	1,166	1,494	1,749	2,332	2,654	2,915
120	994	1,321	1,655	1,916	2,576	2,904	3,237
144	1,161	1,500	1,910	2,249	2,999	3,403	3,748

Series 19

Length Up To	Overall Finished Width						
	42	63	84	105	126	147	168
36	431	524	693	786	1,048	1,211	1,310
48	518	687	862	961	1,304	1,473	1,647
72	693	873	1,129	1,310	1,746	1,996	2,182
84	780	1,036	1,298	1,484	2,002	2,258	2,520
108	955	1,222	1,566	1,833	2,444	2,782	3,055
120	1,042	1,385	1,735	2,008	2,700	3,044	3,393
144	1,211	1,572	1,996	2,351	3,137	3,492	3,922

Series 20

Length Up To	Overall Finished Width						
	42	63	84	105	126	147	168
36	451	548	725	822	1,096	1,267	1,370
48	542	719	902	1,005	1,364	1,541	1,723
72	725	913	1,181	1,370	1,826	2,088	2,282
84	816	1,084	1,358	1,552	2,094	2,362	2,636
108	999	1,278	1,638	1,917	2,556	2,910	3,195
120	1,090	1,449	1,815	2,100	2,824	3,184	3,549
144	1,273	1,644	2,094	2,465	3,287	3,731	4,108

Series 21

Length Up To	Overall Finished Width						
	42	63	84	105	126	147	168
36	471	572	757	858	1,144	1,323	1,430
48	566	751	942	1,049	1,424	1,609	1,799
72	757	953	1,233	1,430	1,906	2,180	2,382
84	852	1,132	1,418	1,620	2,186	2,466	2,752
108	1,043	1,334	1,710	2,001	2,668	3,038	3,335
120	1,138	1,513	1,895	2,192	2,948	3,324	3,705
144	1,329	1,716	2,186	2,573	3,431	3,895	4,288

Series 22

Length Up To	Overall Finished Width						
	42	63	84	105	126	147	168
36	491	596	789	894	1,192	1,379	1,490
48	590	783	982	1,093	1,484	1,677	1,875
72	789	993	1,285	1,490	1,986	2,272	2,482
84	888	1,180	1,478	1,688	2,278	2,570	2,868
108	1,087	1,390	1,782	2,085	2,780	3,166	3,475
120	1,186	1,577	1,975	2,284	3,072	3,464	3,861
144	1,385	1,788	2,278	2,681	3,575	4,059	4,468

Series 23

Length Up To	Overall Finished Width						
	42	63	84	105	126	147	168
36	511	620	821	930	1,240	1,435	1,550
48	614	815	1,022	1,137	1,544	1,745	1,951
72	821	1,033	1,337	1,550	2,066	2,364	2,582
84	924	1,228	1,538	1,756	2,370	2,674	2,984
108	1,131	1,446	1,854	2,169	2,892	3,294	3,615
120	1,234	1,641	2,055	2,376	3,196	3,604	4,017
144	1,441	1,860	2,370	2,789	3,719	4,223	4,648

Series 24

Length Up To	Overall Finished Width						
	42	63	84	105	126	147	168
36	531	644	853	966	1,288	1,491	1,610
48	638	847	1,062	1,181	1,604	1,813	2,027
72	853	1,073	1,389	1,610	2,146	2,456	2,682
84	960	1,276	1,598	1,824	2,462	2,778	3,100
108	1,175	1,502	1,926	2,253	3,004	3,422	3,755
120	1,282	1,705	2,135	2,468	3,320	3,744	4,173
144	1,497	1,932	2,462	2,897	3,863	4,387	4,828

Series 25

Length Up To	Overall Finished Width						
	42	63	84	105	126	147	168
36	561	680	901	1,020	1,360	1,575	1,700
48	674	895	1,122	1,247	1,694	1,915	2,141
72	901	1,133	1,467	1,700	2,266	2,594	2,832
84	1,014	1,348	1,688	1,926	2,600	2,934	3,274
108	1,241	1,586	2,034	2,379	3,172	3,614	3,965
120	1,354	1,801	2,255	2,606	3,506	3,954	4,407
144	1,581	2,040	2,600	3,059	4,079	4,633	5,098

Series 26

Length Up To	Overall Finished Width						
	42	63	84	105	126	147	168
36	581	704	933	1,056	1,408	1,631	1,760
48	698	927	1,162	1,291	1,754	1,983	2,217
72	933	1,173	1,519	1,760	2,346	2,686	2,932
84	1,050	1,396	1,748	1,994	2,692	3,038	3,390
108	1,285	1,642	2,106	2,463	3,284	3,742	4,105
120	1,402	1,865	2,335	2,698	3,630	4,094	4,563
144	1,637	2,112	2,692	3,167	4,223	4,797	5,278

ROD POCKET DRAPERIES: 3 Fullness — Lined (Lining 01000)

Chart pricing for rod pocket single or double. Sizes and series numbers beyond what is listed in the charts below are available—please submit these quote requests via fax or email.

Number of Widths						
3	4	5	6	8	9	10

Number of Widths						
3	4	5	6	8	9	10

Series 7							
Length Up To	Overall Finished Width						
	42	63	84	105	126	147	168
36	320	429	549	658	827	956	1,056
48	362	498	625	740	944	1,080	1,207
60	403	546	680	823	1,061	1,204	1,338
72	444	594	756	906	1,157	1,328	1,469
84	486	663	832	988	1,275	1,452	1,621
96	527	711	887	1,071	1,392	1,576	1,752
101	534	746	921	1,106	1,433	1,624	1,800

Series 8							
Length Up To	Overall Finished Width						
	42	63	84	105	126	147	168
36	345	459	589	703	887	1,026	1,131
48	392	538	675	795	1,019	1,165	1,302
60	438	591	735	888	1,151	1,304	1,448
72	484	644	821	981	1,257	1,443	1,594
84	531	723	907	1,073	1,390	1,582	1,766
96	577	776	967	1,166	1,522	1,721	1,912
101	584	816	1,006	1,206	1,568	1,774	1,965

Series 9							
Length Up To	Overall Finished Width						
	42	63	84	105	126	147	168
36	365	483	621	739	935	1,082	1,191
48	416	570	715	839	1,079	1,233	1,378
60	466	627	779	940	1,223	1,384	1,536
72	516	684	873	1,041	1,337	1,535	1,694
84	567	771	967	1,141	1,482	1,686	1,882
96	617	828	1,031	1,242	1,626	1,837	2,040
101	624	872	1,074	1,286	1,676	1,894	2,097

Series 10							
Length Up To	Overall Finished Width						
	42	63	84	105	126	147	168
36	385	507	653	775	983	1,138	1,251
48	440	602	755	883	1,139	1,301	1,454
60	494	663	823	992	1,295	1,464	1,624
72	548	724	925	1,101	1,417	1,627	1,794
84	603	819	1,027	1,209	1,574	1,790	1,998
96	657	880	1,095	1,318	1,730	1,953	2,168
101	664	928	1,142	1,366	1,784	2,014	2,229

Series 11							
Length Up To	Overall Finished Width						
	42	63	84	105	126	147	168
36	405	531	685	811	1,031	1,194	1,311
48	464	634	795	927	1,199	1,369	1,530
60	522	699	867	1,044	1,367	1,544	1,712
72	580	764	977	1,161	1,497	1,719	1,894
84	639	867	1,087	1,277	1,666	1,894	2,114
96	697	932	1,159	1,394	1,834	2,069	2,296
101	704	984	1,210	1,446	1,892	2,134	2,361

Series 12							
Length Up To	Overall Finished Width						
	42	63	84	105	126	147	168
36	425	555	717	847	1,079	1,250	1,371
48	488	666	835	971	1,259	1,437	1,606
60	550	735	911	1,096	1,439	1,624	1,800
72	612	804	1,029	1,221	1,577	1,811	1,994
84	675	915	1,147	1,345	1,758	1,998	2,230
96	737	984	1,223	1,470	1,938	2,185	2,424
101	744	1,040	1,278	1,526	2,000	2,254	2,493

Series 13							
Length Up To	Overall Finished Width						
	42	63	84	105	126	147	168
36	445	579	749	883	1,127	1,306	1,431
48	512	698	875	1,015	1,319	1,505	1,682
60	578	771	955	1,148	1,511	1,704	1,888
72	644	844	1,081	1,281	1,657	1,903	2,094
84	711	963	1,207	1,413	1,850	2,102	2,346
96	777	1,036	1,287	1,546	2,042	2,301	2,552
101	784	1,096	1,346	1,606	2,108	2,374	2,625

Series 14							
Length Up To	Overall Finished Width						
	42	63	84	105	126	147	168
36	465	603	781	919	1,175	1,362	1,491
48	536	730	915	1,059	1,379	1,573	1,758
60	606	807	999	1,200	1,583	1,784	1,976
72	676	884	1,133	1,341	1,737	1,995	2,194
84	747	1,011	1,267	1,481	1,942	2,206	2,462
96	817	1,088	1,351	1,622	2,146	2,417	2,680
101	824	1,152	1,414	1,686	2,216	2,494	2,757

Series 15							
Length Up To	Overall Finished Width						
	42	63	84	105	126	147	168
36	485	627	813	955	1,223	1,418	1,551
48	560	762	955	1,103	1,439	1,641	1,834
60	634	843	1,043	1,252	1,655	1,864	2,064
72	708	924	1,185	1,401	1,817	2,087	2,294
84	783	1,059	1,327	1,549	2,034	2,310	2,578
96	857	1,140	1,415	1,698	2,250	2,533	2,808
101	864	1,208	1,482	1,766	2,324	2,614	2,889

Series 16							
Length Up To	Overall Finished Width						
	42	63	84	105	126	147	168
36	505	651	845	991	1,271	1,474	1,611
48	584	794	995	1,147	1,499	1,709	1,910
60	662	879	1,087	1,304	1,727	1,944	2,152
72	740	964	1,237	1,461	1,897	2,179	2,394
84	819	1,107	1,387	1,617	2,126	2,414	2,694
96	897	1,192	1,479	1,774	2,354	2,649	2,936
101	904	1,264	1,550	1,846	2,432	2,734	3,021

ROD POCKET DRAPERIES: 3 Fullness — Lined (Lining 01000)

Chart pricing for rod pocket single or double. Sizes and series numbers beyond what is listed in the charts below are available—please submit these quote requests via fax or email.

Number of Widths						
3	4	5	6	8	9	10

Number of Widths						
3	4	5	6	8	9	10

Series 17

Length Up To	Overall Finished Width						
	42	63	84	105	126	147	168
36	525	675	877	1,027	1,319	1,530	1,671
48	608	826	1,035	1,191	1,559	1,777	1,986
60	690	915	1,131	1,356	1,799	2,024	2,240
72	772	1,004	1,289	1,521	1,977	2,271	2,494
84	855	1,155	1,447	1,685	2,218	2,518	2,810
96	937	1,244	1,543	1,850	2,458	2,765	3,064
101	944	1,320	1,618	1,926	2,540	2,854	3,153

Series 18

Length Up To	Overall Finished Width						
	42	63	84	105	126	147	168
36	545	699	909	1,063	1,367	1,586	1,731
48	632	858	1,075	1,235	1,619	1,845	2,062
60	718	951	1,175	1,408	1,871	2,104	2,328
72	804	1,044	1,341	1,581	2,057	2,363	2,594
84	891	1,203	1,507	1,753	2,310	2,622	2,926
96	977	1,296	1,607	1,926	2,562	2,881	3,192
101	984	1,376	1,686	2,006	2,648	2,974	3,285

Series 19

Length Up To	Overall Finished Width						
	42	63	84	105	126	147	168
36	565	723	941	1,099	1,415	1,642	1,791
48	656	890	1,115	1,279	1,679	1,913	2,138
60	746	987	1,219	1,460	1,943	2,184	2,416
72	836	1,084	1,393	1,641	2,137	2,455	2,694
84	927	1,251	1,567	1,821	2,402	2,726	3,042
96	1,017	1,348	1,671	2,002	2,666	2,997	3,320
101	1,024	1,432	1,754	2,086	2,756	3,094	3,417

Series 20

Length Up To	Overall Finished Width						
	42	63	84	105	126	147	168
36	585	747	973	1,135	1,463	1,698	1,851
48	680	922	1,155	1,323	1,739	1,981	2,214
60	774	1,023	1,263	1,512	2,015	2,264	2,504
72	868	1,124	1,445	1,701	2,217	2,547	2,794
84	963	1,299	1,627	1,889	2,494	2,830	3,158
96	1,057	1,400	1,735	2,078	2,770	3,113	3,448
101	1,064	1,488	1,822	2,166	2,864	3,214	3,549

Series 21

Length Up To	Overall Finished Width						
	42	63	84	105	126	147	168
36	605	771	1,005	1,171	1,511	1,754	1,911
48	704	954	1,195	1,367	1,799	2,049	2,290
60	802	1,059	1,307	1,564	2,087	2,344	2,592
72	900	1,164	1,497	1,761	2,297	2,639	2,894
84	999	1,347	1,687	1,957	2,586	2,934	3,274
96	1,097	1,452	1,799	2,154	2,874	3,229	3,576
101	1,104	1,544	1,890	2,246	2,972	3,334	3,681

Series 22

Length Up To	Overall Finished Width						
	42	63	84	105	126	147	168
36	625	795	1,037	1,207	1,559	1,810	1,971
48	728	986	1,235	1,411	1,859	2,117	2,366
60	830	1,095	1,351	1,616	2,159	2,424	2,680
72	932	1,204	1,549	1,821	2,377	2,731	2,994
84	1,035	1,395	1,747	2,025	2,678	3,038	3,390
96	1,137	1,504	1,863	2,230	2,978	3,345	3,704
101	1,144	1,600	1,958	2,326	3,080	3,454	3,813

Series 23

Length Up To	Overall Finished Width						
	42	63	84	105	126	147	168
36	645	819	1,069	1,243	1,607	1,866	2,031
48	752	1,018	1,275	1,455	1,919	2,185	2,442
60	858	1,131	1,395	1,668	2,231	2,504	2,768
72	964	1,244	1,601	1,881	2,457	2,823	3,094
84	1,071	1,443	1,807	2,093	2,770	3,142	3,506
96	1,177	1,556	1,927	2,306	3,082	3,461	3,832
101	1,184	1,656	2,026	2,406	3,188	3,574	3,945

Series 24

Length Up To	Overall Finished Width						
	42	63	84	105	126	147	168
36	665	843	1,101	1,279	1,655	1,922	2,091
48	776	1,050	1,315	1,499	1,979	2,253	2,518
60	886	1,167	1,439	1,720	2,303	2,584	2,856
72	996	1,284	1,653	1,941	2,537	2,915	3,194
84	1,107	1,491	1,867	2,161	2,862	3,246	3,622
96	1,217	1,608	1,991	2,382	3,186	3,577	3,960
101	1,224	1,712	2,094	2,486	3,296	3,694	4,077

Series 25

Length Up To	Overall Finished Width						
	42	63	84	105	126	147	168
36	695	879	1,149	1,333	1,727	2,006	2,181
48	812	1,098	1,375	1,565	2,069	2,355	2,632
60	928	1,221	1,505	1,798	2,411	2,704	2,988
72	1,044	1,344	1,731	2,031	2,657	3,053	3,344
84	1,161	1,563	1,957	2,263	3,000	3,402	3,796
96	1,277	1,686	2,087	2,496	3,342	3,751	4,152
101	1,284	1,796	2,196	2,606	3,458	3,874	4,275

Series 26

Length Up To	Overall Finished Width						
	42	63	84	105	126	147	168
36	715	903	1,181	1,369	1,775	2,062	2,241
48	836	1,130	1,415	1,609	2,129	2,423	2,708
60	956	1,257	1,549	1,850	2,483	2,784	3,076
72	1,076	1,384	1,783	2,091	2,737	3,145	3,444
84	1,197	1,611	2,017	2,331	3,092	3,506	3,912
96	1,317	1,738	2,151	2,572	3,446	3,867	4,280
101	1,324	1,852	2,264	2,686	3,566	3,994	4,407

ROD POCKET DRAPERIES: 4 Fullness — Unlined

Chart pricing for rod pocket single or double. Sizes and series numbers beyond what is listed in the charts below are available—please submit these quote requests via fax or email.

Number of Widths						
4	5	7	8	10	12	13

Number of Widths						
4	5	7	8	10	12	13

Series 7							
Length Up To	Overall Finished Width						
	42	63	84	105	126	147	168
36	230	301	410	460	575	684	755
48	295	372	492	569	716	837	913
72	383	492	678	766	957	1,143	1,252
84	448	563	760	875	1,099	1,296	1,411
108	536	684	946	1,072	1,340	1,602	1,750
120	601	755	1,028	1,181	1,482	1,756	1,909
144	690	875	1,214	1,379	1,723	2,062	2,247

Series 8							
Length Up To	Overall Finished Width						
	42	63	84	105	126	147	168
36	260	341	465	520	650	774	855
48	335	422	557	644	811	947	1,033
72	433	557	768	866	1,082	1,293	1,417
84	508	638	860	990	1,244	1,466	1,596
108	606	774	1,071	1,212	1,515	1,812	1,980
120	681	855	1,163	1,336	1,677	1,986	2,159
144	780	990	1,374	1,559	1,948	2,332	2,542

Series 9							
Length Up To	Overall Finished Width						
	42	63	84	105	126	147	168
36	284	373	509	568	710	846	935
48	367	462	609	704	887	1,035	1,129
72	473	609	840	946	1,182	1,413	1,549
84	556	698	940	1,082	1,360	1,602	1,744
108	662	846	1,171	1,324	1,655	1,980	2,164
120	745	935	1,271	1,460	1,833	2,170	2,359
144	852	1,082	1,502	1,703	2,128	2,548	2,778

Series 10							
Length Up To	Overall Finished Width						
	42	63	84	105	126	147	168
36	308	405	553	616	770	918	1,015
48	399	502	661	764	963	1,123	1,225
72	513	661	912	1,026	1,282	1,533	1,681
84	604	758	1,020	1,174	1,476	1,738	1,892
108	718	918	1,271	1,436	1,795	2,148	2,348
120	809	1,015	1,379	1,584	1,989	2,354	2,559
144	924	1,174	1,630	1,847	2,308	2,764	3,014

Series 11							
Length Up To	Overall Finished Width						
	42	63	84	105	126	147	168
36	332	437	597	664	830	990	1,095
48	431	542	713	824	1,039	1,211	1,321
72	553	713	984	1,106	1,382	1,653	1,813
84	652	818	1,100	1,266	1,592	1,874	2,040
108	774	990	1,371	1,548	1,935	2,316	2,532
120	873	1,095	1,487	1,708	2,145	2,538	2,759
144	996	1,266	1,758	1,991	2,488	2,980	3,250

Series 12							
Length Up To	Overall Finished Width						
	42	63	84	105	126	147	168
36	356	469	641	712	890	1,062	1,175
48	463	582	765	884	1,115	1,299	1,417
72	593	765	1,056	1,186	1,482	1,773	1,945
84	700	878	1,180	1,358	1,708	2,010	2,188
108	830	1,062	1,471	1,660	2,075	2,484	2,716
120	937	1,175	1,595	1,832	2,301	2,722	2,959
144	1,068	1,358	1,886	2,135	2,668	3,196	3,486

Series 13							
Length Up To	Overall Finished Width						
	42	63	84	105	126	147	168
36	380	501	685	760	950	1,134	1,255
48	495	622	817	944	1,191	1,387	1,513
72	633	817	1,128	1,266	1,582	1,893	2,077
84	748	938	1,260	1,450	1,824	2,146	2,336
108	886	1,134	1,571	1,772	2,215	2,652	2,900
120	1,001	1,255	1,703	1,956	2,457	2,906	3,159
144	1,140	1,450	2,014	2,279	2,848	3,412	3,722

Series 14							
Length Up To	Overall Finished Width						
	42	63	84	105	126	147	168
36	404	533	729	808	1,010	1,206	1,335
48	527	662	869	1,004	1,267	1,475	1,609
72	673	869	1,200	1,346	1,682	2,013	2,209
84	796	998	1,340	1,542	1,940	2,282	2,484
108	942	1,206	1,671	1,884	2,355	2,820	3,084
120	1,065	1,335	1,811	2,080	2,613	3,090	3,359
144	1,212	1,542	2,142	2,423	3,028	3,628	3,958

Series 15							
Length Up To	Overall Finished Width						
	42	63	84	105	126	147	168
36	428	565	773	856	1,070	1,278	1,415
48	559	702	921	1,064	1,343	1,563	1,705
72	713	921	1,272	1,426	1,782	2,133	2,341
84	844	1,058	1,420	1,634	2,056	2,418	2,632
108	998	1,278	1,771	1,996	2,495	2,988	3,268
120	1,129	1,415	1,919	2,204	2,769	3,274	3,559
144	1,284	1,634	2,270	2,567	3,208	3,844	4,194

Series 16							
Length Up To	Overall Finished Width						
	42	63	84	105	126	147	168
36	452	597	817	904	1,130	1,350	1,495
48	591	742	973	1,124	1,419	1,651	1,801
72	753	973	1,344	1,506	1,882	2,253	2,473
84	892	1,118	1,500	1,726	2,172	2,554	2,780
108	1,054	1,350	1,871	2,108	2,635	3,156	3,452
120	1,193	1,495	2,027	2,328	2,925	3,458	3,759
144	1,356	1,726	2,398	2,711	3,388	4,060	4,430

ROD POCKET DRAPERIES: 4 Fullness — Unlined

Chart pricing for rod pocket single or double. Sizes and series numbers beyond what is listed in the charts below are available—please submit these quote requests via fax or email.

Number of Widths						
4	5	7	8	10	12	13

Number of Widths						
4	5	7	8	10	12	13

Series 17

Length Up To	Overall Finished Width						
	42	63	84	105	126	147	168
36	476	629	861	952	1,190	1,422	1,575
48	623	782	1,025	1,184	1,495	1,739	1,897
72	793	1,025	1,416	1,586	1,982	2,373	2,605
84	940	1,178	1,580	1,818	2,288	2,690	2,928
108	1,110	1,422	1,971	2,220	2,775	3,324	3,636
120	1,257	1,575	2,135	2,452	3,081	3,642	3,959
144	1,428	1,818	2,526	2,855	3,568	4,276	4,666

Series 18

Length Up To	Overall Finished Width						
	42	63	84	105	126	147	168
36	500	661	905	1,000	1,250	1,494	1,655
48	655	822	1,077	1,244	1,571	1,827	1,993
72	833	1,077	1,488	1,666	2,082	2,493	2,737
84	988	1,238	1,660	1,910	2,404	2,826	3,076
108	1,166	1,494	2,071	2,332	2,915	3,492	3,820
120	1,321	1,655	2,243	2,576	3,237	3,826	4,159
144	1,500	1,910	2,654	2,999	3,748	4,492	4,902

Series 19

Length Up To	Overall Finished Width						
	42	63	84	105	126	147	168
36	524	693	949	1,048	1,310	1,566	1,735
48	687	862	1,129	1,304	1,647	1,915	2,089
72	873	1,129	1,560	1,746	2,182	2,613	2,869
84	1,036	1,298	1,740	2,002	2,520	2,962	3,224
108	1,222	1,566	2,171	2,444	3,055	3,660	4,004
120	1,385	1,735	2,351	2,700	3,393	4,010	4,359
144	1,572	2,002	2,782	3,143	3,928	4,708	5,138

Series 20

Length Up To	Overall Finished Width						
	42	63	84	105	126	147	168
36	548	725	993	1,096	1,370	1,638	1,815
48	719	902	1,181	1,364	1,723	2,003	2,185
72	913	1,181	1,632	1,826	2,282	2,733	3,001
84	1,084	1,358	1,820	2,094	2,636	3,098	3,372
108	1,278	1,638	2,271	2,556	3,195	3,828	4,188
120	1,449	1,815	2,459	2,824	3,549	4,194	4,559
144	1,644	2,094	2,910	3,287	4,108	4,924	5,374

Series 21

Length Up To	Overall Finished Width						
	42	63	84	105	126	147	168
36	572	757	1,037	1,144	1,430	1,710	1,895
48	751	942	1,233	1,424	1,799	2,091	2,281
72	953	1,233	1,704	1,906	2,382	2,853	3,133
84	1,132	1,418	1,900	2,186	2,752	3,234	3,520
108	1,334	1,710	2,371	2,668	3,335	3,996	4,372
120	1,513	1,895	2,567	2,948	3,705	4,378	4,759
144	1,716	2,186	3,038	3,431	4,288	5,140	5,610

Series 22

Length Up To	Overall Finished Width						
	42	63	84	105	126	147	168
36	596	789	1,081	1,192	1,490	1,782	1,975
48	783	982	1,285	1,484	1,875	2,179	2,377
72	993	1,285	1,776	1,986	2,482	2,973	3,265
84	1,180	1,478	1,980	2,278	2,868	3,370	3,668
108	1,390	1,782	2,471	2,780	3,475	4,164	4,556
120	1,577	1,975	2,675	3,072	3,861	4,562	4,959
144	1,788	2,278	3,166	3,575	4,468	5,356	5,846

Series 23

Length Up To	Overall Finished Width						
	42	63	84	105	126	147	168
36	620	821	1,125	1,240	1,550	1,854	2,055
48	815	1,022	1,337	1,544	1,951	2,267	2,473
72	1,033	1,337	1,848	2,066	2,582	3,093	3,397
84	1,228	1,538	2,060	2,370	2,984	3,506	3,816
108	1,446	1,854	2,571	2,892	3,615	4,332	4,740
120	1,641	2,055	2,783	3,196	4,017	4,746	5,159
144	1,860	2,370	3,294	3,719	4,648	5,572	6,082

Series 24

Length Up To	Overall Finished Width						
	42	63	84	105	126	147	168
36	644	853	1,169	1,288	1,610	1,926	2,135
48	847	1,062	1,389	1,604	2,027	2,355	2,569
72	1,073	1,389	1,920	2,146	2,682	3,213	3,529
84	1,276	1,598	2,140	2,462	3,100	3,642	3,964
108	1,502	1,926	2,671	3,004	3,755	4,500	4,924
120	1,705	2,135	2,891	3,320	4,173	4,930	5,359
144	1,932	2,462	3,422	3,863	4,828	5,788	6,318

Series 25

Length Up To	Overall Finished Width						
	42	63	84	105	126	147	168
36	680	901	1,235	1,360	1,700	2,034	2,255
48	895	1,122	1,467	1,694	2,141	2,487	2,713
72	1,133	1,467	2,028	2,266	2,832	3,393	3,727
84	1,348	1,688	2,260	2,600	3,274	3,846	4,186
108	1,586	2,034	2,821	3,172	3,965	4,752	5,200
120	1,801	2,255	3,053	3,506	4,407	5,206	5,659
144	2,040	2,600	3,614	4,079	5,098	6,112	6,672

Series 26

Length Up To	Overall Finished Width						
	42	63	84	105	126	147	168
36	704	933	1,279	1,408	1,760	2,106	2,335
48	927	1,162	1,519	1,754	2,217	2,575	2,809
72	1,173	1,519	2,100	2,346	2,932	3,513	3,859
84	1,396	1,748	2,340	2,692	3,390	3,982	4,334
108	1,642	2,106	2,921	3,284	4,105	4,920	5,384
120	1,865	2,335	3,161	3,630	4,563	5,390	5,859
144	2,112	2,692	3,742	4,223	5,278	6,328	6,908

ROD POCKET DRAPERIES: 4 Fullness — Lined (Lining 01000)

Chart pricing for rod pocket single or double. Sizes and series numbers beyond what is listed in the charts below are available—please submit these quote requests via fax or email.

Number of Widths						
4	5	7	8	10	12	13

Number of Widths						
4	5	7	8	10	12	13

Series 7							
Length Up To	Overall Finished Width						
	42	63	84	105	126	147	168
36	414	549	742	872	1,056	1,248	1,399
48	483	625	831	989	1,207	1,413	1,571
60	531	680	921	1,106	1,338	1,579	1,743
72	579	756	1,031	1,202	1,469	1,744	1,936
84	648	832	1,121	1,320	1,621	1,909	2,108
96	696	887	1,210	1,437	1,752	2,075	2,280
101	731	921	1,251	1,478	1,800	2,151	2,356

Series 8							
Length Up To	Overall Finished Width						
	42	63	84	105	126	147	168
36	444	589	797	932	1,131	1,338	1,499
48	523	675	896	1,064	1,302	1,523	1,691
60	576	735	996	1,196	1,448	1,709	1,883
72	629	821	1,121	1,302	1,594	1,894	2,101
84	708	907	1,221	1,435	1,766	2,079	2,293
96	761	967	1,320	1,567	1,912	2,265	2,485
101	801	1,006	1,366	1,613	1,965	2,351	2,571

Series 9							
Length Up To	Overall Finished Width						
	42	63	84	105	126	147	168
36	468	621	841	980	1,191	1,410	1,579
48	555	715	948	1,124	1,378	1,611	1,787
60	612	779	1,056	1,268	1,536	1,813	1,995
72	669	873	1,193	1,382	1,694	2,014	2,233
84	756	967	1,301	1,527	1,882	2,215	2,441
96	813	1,031	1,408	1,671	2,040	2,417	2,649
101	857	1,074	1,458	1,721	2,097	2,511	2,743

Series 10							
Length Up To	Overall Finished Width						
	42	63	84	105	126	147	168
36	492	653	885	1,028	1,251	1,482	1,659
48	587	755	1,000	1,184	1,454	1,699	1,883
60	648	823	1,116	1,340	1,624	1,917	2,107
72	709	925	1,265	1,462	1,794	2,134	2,365
84	804	1,027	1,381	1,619	1,998	2,351	2,589
96	865	1,095	1,496	1,775	2,168	2,569	2,813
101	913	1,142	1,550	1,829	2,229	2,671	2,915

Series 11							
Length Up To	Overall Finished Width						
	42	63	84	105	126	147	168
36	516	685	929	1,076	1,311	1,554	1,739
48	619	795	1,052	1,244	1,530	1,787	1,979
60	684	867	1,176	1,412	1,712	2,021	2,219
72	749	977	1,337	1,542	1,894	2,254	2,497
84	852	1,087	1,461	1,711	2,114	2,487	2,737
96	917	1,159	1,584	1,879	2,296	2,721	2,977
101	969	1,210	1,642	1,937	2,361	2,831	3,087

Series 12							
Length Up To	Overall Finished Width						
	42	63	84	105	126	147	168
36	540	717	973	1,124	1,371	1,626	1,819
48	651	835	1,104	1,304	1,606	1,875	2,075
60	720	911	1,236	1,484	1,800	2,125	2,331
72	789	1,029	1,409	1,622	1,994	2,374	2,629
84	900	1,147	1,541	1,803	2,230	2,623	2,885
96	969	1,223	1,672	1,983	2,424	2,873	3,141
101	1,025	1,278	1,734	2,045	2,493	2,991	3,259

Series 13							
Length Up To	Overall Finished Width						
	42	63	84	105	126	147	168
36	564	749	1,017	1,172	1,431	1,698	1,899
48	683	875	1,156	1,364	1,682	1,963	2,171
60	756	955	1,296	1,556	1,888	2,229	2,443
72	829	1,081	1,481	1,702	2,094	2,494	2,761
84	948	1,207	1,621	1,895	2,346	2,759	3,033
96	1,021	1,287	1,760	2,087	2,552	3,025	3,305
101	1,081	1,346	1,826	2,153	2,625	3,151	3,431

Series 14							
Length Up To	Overall Finished Width						
	42	63	84	105	126	147	168
36	588	781	1,061	1,220	1,491	1,770	1,979
48	715	915	1,208	1,424	1,758	2,051	2,267
60	792	999	1,356	1,628	1,976	2,333	2,555
72	869	1,133	1,553	1,782	2,194	2,614	2,893
84	996	1,267	1,701	1,987	2,462	2,895	3,181
96	1,073	1,351	1,848	2,191	2,680	3,177	3,469
101	1,137	1,414	1,918	2,261	2,757	3,311	3,603

Series 15							
Length Up To	Overall Finished Width						
	42	63	84	105	126	147	168
36	612	813	1,105	1,268	1,551	1,842	2,059
48	747	955	1,260	1,484	1,834	2,139	2,363
60	828	1,043	1,416	1,700	2,064	2,437	2,667
72	909	1,185	1,625	1,862	2,294	2,734	3,025
84	1,044	1,327	1,781	2,079	2,578	3,031	3,329
96	1,125	1,415	1,936	2,295	2,808	3,329	3,633
101	1,193	1,482	2,010	2,369	2,889	3,471	3,775

Series 16							
Length Up To	Overall Finished Width						
	42	63	84	105	126	147	168
36	636	845	1,149	1,316	1,611	1,914	2,139
48	779	995	1,312	1,544	1,910	2,227	2,459
60	864	1,087	1,476	1,772	2,152	2,541	2,779
72	949	1,237	1,697	1,942	2,394	2,854	3,157
84	1,092	1,387	1,861	2,171	2,694	3,167	3,477
96	1,177	1,479	2,024	2,399	2,936	3,481	3,797
101	1,249	1,550	2,102	2,477	3,021	3,631	3,947

ROD POCKET DRAPERIES: 4 Fullness — Lined (Lining 01000)

Chart pricing for rod pocket single or double. Sizes and series numbers beyond what is listed in the charts below are available—please submit these quote requests via fax or email.

Number of Widths						
4	5	7	8	10	12	13

Number of Widths						
4	5	7	8	10	12	13

Series 17

Length Up To	Overall Finished Width						
	42	63	84	105	126	147	168
36	660	877	1,193	1,364	1,671	1,986	2,219
48	811	1,035	1,364	1,604	1,986	2,315	2,555
60	900	1,131	1,536	1,844	2,240	2,645	2,891
72	989	1,289	1,769	2,022	2,494	2,974	3,289
84	1,140	1,447	1,941	2,263	2,810	3,303	3,625
96	1,229	1,543	2,112	2,503	3,064	3,633	3,961
101	1,305	1,618	2,194	2,585	3,153	3,791	4,119

Series 18

Length Up To	Overall Finished Width						
	42	63	84	105	126	147	168
36	684	909	1,237	1,412	1,731	2,058	2,299
48	843	1,075	1,416	1,664	2,062	2,403	2,651
60	936	1,175	1,596	1,916	2,328	2,749	3,003
72	1,029	1,341	1,841	2,102	2,594	3,094	3,421
84	1,188	1,507	2,021	2,355	2,926	3,439	3,773
96	1,281	1,607	2,200	2,607	3,192	3,785	4,125
101	1,361	1,686	2,286	2,693	3,285	3,951	4,291

Series 19

Length Up To	Overall Finished Width						
	42	63	84	105	126	147	168
36	708	941	1,281	1,460	1,791	2,130	2,379
48	875	1,115	1,468	1,724	2,138	2,491	2,747
60	972	1,219	1,656	1,988	2,416	2,853	3,115
72	1,069	1,393	1,913	2,182	2,694	3,214	3,553
84	1,236	1,567	2,101	2,447	3,042	3,575	3,921
96	1,333	1,671	2,288	2,711	3,320	3,937	4,289
101	1,417	1,754	2,378	2,801	3,417	4,111	4,463

Series 20

Length Up To	Overall Finished Width						
	42	63	84	105	126	147	168
36	732	973	1,325	1,508	1,851	2,202	2,459
48	907	1,155	1,520	1,784	2,214	2,579	2,843
60	1,008	1,263	1,716	2,060	2,504	2,957	3,227
72	1,109	1,445	1,985	2,262	2,794	3,334	3,685
84	1,284	1,627	2,181	2,539	3,158	3,711	4,069
96	1,385	1,735	2,376	2,815	3,448	4,089	4,453
101	1,473	1,822	2,470	2,909	3,549	4,271	4,635

Series 21

Length Up To	Overall Finished Width						
	42	63	84	105	126	147	168
36	756	1,005	1,369	1,556	1,911	2,274	2,539
48	939	1,195	1,572	1,844	2,290	2,667	2,939
60	1,044	1,307	1,776	2,132	2,592	3,061	3,339
72	1,149	1,497	2,057	2,342	2,894	3,454	3,817
84	1,332	1,687	2,261	2,631	3,274	3,847	4,217
96	1,437	1,799	2,464	2,919	3,576	4,241	4,617
101	1,529	1,890	2,562	3,017	3,681	4,431	4,807

Series 22

Length Up To	Overall Finished Width						
	42	63	84	105	126	147	168
36	780	1,037	1,413	1,604	1,971	2,346	2,619
48	971	1,235	1,624	1,904	2,366	2,755	3,035
60	1,080	1,351	1,836	2,204	2,680	3,165	3,451
72	1,189	1,549	2,129	2,422	2,994	3,574	3,949
84	1,380	1,747	2,341	2,723	3,390	3,983	4,365
96	1,489	1,863	2,552	3,023	3,704	4,393	4,781
101	1,585	1,958	2,654	3,125	3,813	4,591	4,979

Series 23

Length Up To	Overall Finished Width						
	42	63	84	105	126	147	168
36	804	1,069	1,457	1,652	2,031	2,418	2,699
48	1,003	1,275	1,676	1,964	2,442	2,843	3,131
60	1,116	1,395	1,896	2,276	2,768	3,269	3,563
72	1,229	1,601	2,201	2,502	3,094	3,694	4,081
84	1,428	1,807	2,421	2,815	3,506	4,119	4,513
96	1,541	1,927	2,640	3,127	3,832	4,545	4,945
101	1,641	2,026	2,746	3,233	3,945	4,751	5,151

Series 24

Length Up To	Overall Finished Width						
	42	63	84	105	126	147	168
36	828	1,101	1,501	1,700	2,091	2,490	2,779
48	1,035	1,315	1,728	2,024	2,518	2,931	3,227
60	1,152	1,439	1,956	2,348	2,856	3,373	3,675
72	1,269	1,653	2,273	2,582	3,194	3,814	4,213
84	1,476	1,867	2,501	2,907	3,622	4,255	4,661
96	1,593	1,991	2,728	3,231	3,960	4,697	5,109
101	1,697	2,094	2,838	3,341	4,077	4,911	5,323

Series 25

Length Up To	Overall Finished Width						
	42	63	84	105	126	147	168
36	864	1,149	1,567	1,772	2,181	2,598	2,899
48	1,083	1,375	1,806	2,114	2,632	3,063	3,371
60	1,206	1,505	2,046	2,456	2,988	3,529	3,843
72	1,329	1,731	2,381	2,702	3,344	3,994	4,411
84	1,548	1,957	2,621	3,045	3,796	4,459	4,883
96	1,671	2,087	2,860	3,387	4,152	4,925	5,355
101	1,781	2,196	2,976	3,503	4,275	5,151	5,581

Series 26

Length Up To	Overall Finished Width						
	42	63	84	105	126	147	168
36	888	1,181	1,611	1,820	2,241	2,670	2,979
48	1,115	1,415	1,858	2,174	2,708	3,151	3,467
60	1,242	1,549	2,106	2,528	3,076	3,633	3,955
72	1,369	1,783	2,453	2,782	3,444	4,114	4,543
84	1,596	2,017	2,701	3,137	3,912	4,595	5,031
96	1,723	2,151	2,948	3,491	4,280	5,077	5,519
101	1,837	2,264	3,068	3,611	4,407	5,311	5,753

TOP TREATMENTS: Board Mount

Series numbers beyond what is listed in the charts below are available—please submit these quote requests via fax or email.

KICK PLEAT VALANCE

Series	Face Width in Inches								
	36"	54"	72"	90"	108"	126"	144"	162"	180"
07	252	386	503	616	713	847	943	1,077	1,173
08	267	406	533	646	748	887	988	1,127	1,228
09	279	422	557	670	776	919	1,024	1,167	1,272
10	291	438	581	694	804	951	1,060	1,207	1,316
11	303	454	605	718	832	983	1,096	1,247	1,360
12	315	470	629	742	860	1,015	1,132	1,287	1,404
13	327	486	653	766	888	1,047	1,168	1,327	1,448
14	339	502	677	790	916	1,079	1,204	1,367	1,492
15	351	518	701	814	944	1,111	1,240	1,407	1,536
16	363	534	725	838	972	1,143	1,276	1,447	1,580
17	375	550	749	862	1,000	1,175	1,312	1,487	1,624
18	387	566	773	886	1,028	1,207	1,348	1,527	1,668
19	399	582	797	910	1,056	1,239	1,384	1,567	1,712
20	411	598	821	934	1,084	1,271	1,420	1,607	1,756
21	423	614	845	958	1,112	1,303	1,456	1,647	1,800
22	435	630	869	982	1,140	1,335	1,492	1,687	1,844
23	447	646	893	1,006	1,168	1,367	1,528	1,727	1,888
24	459	662	917	1,030	1,196	1,399	1,564	1,767	1,932
25	477	686	953	1,066	1,238	1,447	1,618	1,827	1,998
26	489	702	977	1,090	1,266	1,479	1,654	1,867	2,042

ARCH-SHAPED VALANCE

Series	Face Width in Inches								
	36"	54"	72"	90"	108"	126"	144"	162"	180"
07	285	405	506	648	727	869	969	1,090	1,190
08	305	425	531	678	757	904	1,009	1,130	1,235
09	321	441	551	702	781	932	1,041	1,162	1,271
10	337	457	571	726	805	960	1,073	1,194	1,307
11	353	473	591	750	829	988	1,105	1,226	1,343
12	369	489	611	774	853	1,016	1,137	1,258	1,379
13	385	505	631	798	877	1,044	1,169	1,290	1,415
14	401	521	651	822	901	1,072	1,201	1,322	1,451
15	417	537	671	846	925	1,100	1,233	1,354	1,487
16	433	553	691	870	949	1,128	1,265	1,386	1,523
17	449	569	711	894	973	1,156	1,297	1,418	1,559
18	465	585	731	918	997	1,184	1,329	1,450	1,595
19	481	601	751	942	1,021	1,212	1,361	1,482	1,631
20	497	617	771	966	1,045	1,240	1,393	1,514	1,667
21	513	633	791	990	1,069	1,268	1,425	1,546	1,703
22	529	649	811	1,014	1,093	1,296	1,457	1,578	1,739
23	545	665	831	1,038	1,117	1,324	1,489	1,610	1,775
24	561	681	851	1,062	1,141	1,352	1,521	1,642	1,811
25	585	705	881	1,098	1,177	1,394	1,569	1,690	1,865
26	601	721	901	1,122	1,201	1,422	1,601	1,722	1,901

TOP TREATMENTS: Board Mount

Series numbers beyond what is listed in the charts below are available—please submit these quote requests via fax or email.

BOX PLEATED VALANCE

Series	Face Width in Inches								
	36"	54"	72"	90"	108"	126"	144"	162"	180"
07	233	333	444	545	635	756	846	968	1,058
08	248	348	469	570	665	791	886	1,013	1,108
09	260	360	489	590	689	819	918	1,049	1,148
10	272	372	509	610	713	847	950	1,085	1,188
11	284	384	529	630	737	875	982	1,121	1,228
12	296	396	549	650	761	903	1,014	1,157	1,268
13	308	408	569	670	785	931	1,046	1,193	1,308
14	320	420	589	690	809	959	1,078	1,229	1,348
15	332	432	609	710	833	987	1,110	1,265	1,388
16	344	444	629	730	857	1,015	1,142	1,301	1,428
17	356	456	649	750	881	1,043	1,174	1,337	1,468
18	368	468	669	770	905	1,071	1,206	1,373	1,508
19	380	480	689	790	929	1,099	1,238	1,409	1,548
20	392	492	709	810	953	1,127	1,270	1,445	1,588
21	404	504	729	830	977	1,155	1,302	1,481	1,628
22	416	516	749	850	1,001	1,183	1,334	1,517	1,668
23	428	528	769	870	1,025	1,211	1,366	1,553	1,708
24	440	540	789	890	1,049	1,239	1,398	1,589	1,748
25	458	558	819	920	1,085	1,281	1,446	1,643	1,808
26	470	570	839	940	1,109	1,309	1,478	1,679	1,848

SCALLOP-SHAPED VALANCE

Series	Face Width in Inches								
	36"	54"	72"	90"	108"	126"	144"	162"	180"
07	233	396	486	608	719	840	930	1,052	1,121
08	248	426	521	648	769	895	990	1,117	1,186
09	260	450	549	680	809	939	1,038	1,169	1,238
10	272	474	577	712	849	983	1,086	1,221	1,290
11	284	498	605	744	889	1,027	1,134	1,273	1,342
12	296	522	633	776	929	1,071	1,182	1,325	1,394
13	308	546	661	808	969	1,115	1,230	1,377	1,446
14	320	570	689	840	1,009	1,159	1,278	1,429	1,498
15	332	594	717	872	1,049	1,203	1,326	1,481	1,550
16	344	618	745	904	1,089	1,247	1,374	1,533	1,602
17	356	642	773	936	1,129	1,291	1,422	1,585	1,654
18	368	666	801	968	1,169	1,335	1,470	1,637	1,706
19	380	690	829	1,000	1,209	1,379	1,518	1,689	1,758
20	392	714	857	1,032	1,249	1,423	1,566	1,741	1,810
21	404	738	885	1,064	1,289	1,467	1,614	1,793	1,862
22	416	762	913	1,096	1,329	1,511	1,662	1,845	1,914
23	428	786	941	1,128	1,369	1,555	1,710	1,897	1,966
24	440	810	969	1,160	1,409	1,599	1,758	1,949	2,018
25	458	846	1,011	1,208	1,469	1,665	1,830	2,027	2,096
26	470	870	1,039	1,240	1,509	1,709	1,878	2,079	2,148

TOP TREATMENTS: Rod Mount — Gathered Sleeves

Series numbers beyond what is listed in the charts below are available—please submit these quote requests via fax or email.

GATHERED SLEEVE VALANCE

Series	Face Width in Inches								
	48"	72"	92"	120"	144"	168"	192"	216"	240"
07	118	135	152	210	227	286	303	320	378
08	138	155	172	240	257	326	343	360	428
09	154	171	188	264	281	358	375	392	468
10	170	187	204	288	305	390	407	424	508
11	186	203	220	312	329	422	439	456	548
12	202	219	236	336	353	454	471	488	588
13	218	235	252	360	377	486	503	520	628
14	234	251	268	384	401	518	535	552	668
15	250	267	284	408	425	550	567	584	708
16	266	283	300	432	449	582	599	616	748
17	282	299	316	456	473	614	631	648	788
18	298	315	332	480	497	646	663	680	828
19	314	331	348	504	521	678	695	712	868
20	330	347	364	528	545	710	727	744	908
21	346	363	380	552	569	742	759	776	948
22	362	379	396	576	593	774	791	808	988
23	378	395	412	600	617	806	823	840	1,028
24	394	411	428	624	641	838	855	872	1,068
25	418	435	452	660	677	886	903	920	1,128
26	434	451	468	684	701	918	935	952	1,168

GATHERED SLEEVE VALANCE WITH HEADERS

Series	Face Width in Inches								
	48"	72"	92"	120"	144"	168"	192"	216"	240"
07	66	99	111	143	155	167	221	232	265
08	76	114	126	163	175	187	251	262	300
09	84	126	138	179	191	203	275	286	328
10	92	138	150	195	207	219	299	310	356
11	100	150	162	211	223	235	323	334	384
12	108	162	174	227	239	251	347	358	412
13	116	174	186	243	255	267	371	382	440
14	124	186	198	259	271	283	395	406	468
15	132	198	210	275	287	299	419	430	496
16	140	210	222	291	303	315	443	454	524
17	148	222	234	307	319	331	467	478	552
18	156	234	246	323	335	347	491	502	580
19	164	246	258	339	351	363	515	526	608
20	172	258	270	355	367	379	539	550	636
21	180	270	282	371	383	395	563	574	664
22	188	282	294	387	399	411	587	598	692
23	196	294	306	403	415	427	611	622	720
24	204	306	318	419	431	443	635	646	748
25	216	324	336	443	455	467	671	682	790
26	224	336	348	459	471	483	695	706	818

TOP TREATMENTS: Rod Mount — Pleated

Series numbers beyond what is listed in the charts below are available—please submit these quote requests via fax or email.

UNLINED — 2.5 FULLNESS — PINCH / BOHEMIAN / GOBLET PLEAT

Series	Overall Finished Width								
	48"	72"	96"	105"	120"	144"	168"	192"	240"
07	162	222	282	301	342	402	462	564	683
08	182	247	312	331	377	442	507	624	753
09	198	267	336	355	405	474	543	672	809
10	214	287	360	379	433	506	579	720	865
11	230	307	384	403	461	538	615	768	921
12	246	327	408	427	489	570	651	816	977
13	262	347	432	451	517	602	687	864	1,033
14	278	367	456	475	545	634	723	912	1,089
15	294	387	480	499	573	666	759	960	1,145
16	310	407	504	523	601	698	795	1,008	1,201
17	326	427	528	547	629	730	831	1,056	1,257
18	342	447	552	571	657	762	867	1,104	1,313
19	358	467	576	595	685	794	903	1,152	1,369
20	374	487	600	619	713	826	939	1,200	1,425
21	390	507	624	643	741	858	975	1,248	1,481
22	406	527	648	667	769	890	1,011	1,296	1,537
23	422	547	672	691	797	922	1,047	1,344	1,593
24	438	567	696	715	825	954	1,083	1,392	1,649
25	462	597	732	751	867	1,002	1,137	1,464	1,733
26	478	617	756	775	895	1,034	1,173	1,512	1,789

LINED — 2.5 FULLNESS — PINCH / BOHEMIAN / GOBLET PLEAT

Series	Overall Finished Width								
	48"	72"	96"	105"	120"	144"	168"	192"	240"
07	181	246	311	331	376	442	507	622	752
08	201	271	341	361	411	482	552	682	822
09	217	291	365	385	439	514	588	730	878
10	233	311	389	409	467	546	624	778	934
11	249	331	413	433	495	578	660	826	990
12	265	351	437	457	523	610	696	874	1,046
13	281	371	461	481	551	642	732	922	1,102
14	297	391	485	505	579	674	768	970	1,158
15	313	411	509	529	607	706	804	1,018	1,214
16	329	431	533	553	635	738	840	1,066	1,270
17	345	451	557	577	663	770	876	1,114	1,326
18	361	471	581	601	691	802	912	1,162	1,382
19	377	491	605	625	719	834	948	1,210	1,438
20	393	511	629	649	747	866	984	1,258	1,494
21	409	531	653	673	775	898	1,020	1,306	1,550
22	425	551	677	697	803	930	1,056	1,354	1,606
23	441	571	701	721	831	962	1,092	1,402	1,662
24	457	591	725	745	859	994	1,128	1,450	1,718
25	481	621	761	781	901	1,042	1,182	1,522	1,802
26	497	641	785	805	929	1,074	1,218	1,570	1,858

TOP TREATMENTS: Rod Mount — Grommet

Chart pricing includes grommets and lengths up to 24". Series numbers beyond what is listed in the charts below are available—please submit these quote requests via fax or email.

UNLINED — 2.5 FULLNESS — GROMMET

Series	Overall Finished Width								
	36"	54"	72"	90"	108"	126"	144"	162"	180"
07	107	164	203	270	309	345	384	441	480
08	119	181	225	300	344	380	424	486	530
09	129	195	243	324	372	408	456	522	570
10	139	209	261	348	400	436	488	558	610
11	149	223	279	372	428	464	520	594	650
12	159	237	297	396	456	492	552	630	690
13	169	251	315	420	484	520	584	666	730
14	179	265	333	444	512	548	616	702	770
15	189	279	351	468	540	576	648	738	810
16	199	293	369	492	568	604	680	774	850
17	209	307	387	516	596	632	712	810	890
18	219	321	405	540	624	660	744	846	930
19	229	335	423	564	652	688	776	882	970
20	239	349	441	588	680	716	808	918	1,010
21	249	363	459	612	708	744	840	954	1,050
22	259	377	477	636	736	772	872	990	1,090
23	269	391	495	660	764	800	904	1,026	1,130
24	279	405	513	684	792	828	936	1,062	1,170
25	294	426	540	720	834	870	984	1,116	1,230
26	304	440	558	744	862	898	1,016	1,152	1,270

LINED — 2.5 FULLNESS — GROMMET

Series	Overall Finished Width								
	36"	54"	72"	90"	108"	126"	144"	162"	180"
07	127	194	240	320	366	408	455	522	568
08	139	211	263	350	401	443	495	567	618
09	149	225	281	374	429	471	527	603	658
10	159	239	299	398	457	499	559	639	698
11	169	253	317	422	485	527	591	675	738
12	179	267	335	446	513	555	623	711	778
13	189	281	353	470	541	583	655	747	818
14	199	295	371	494	569	611	687	783	858
15	209	309	389	518	597	639	719	819	898
16	219	323	407	542	625	667	751	855	938
17	229	337	425	566	653	695	783	891	978
18	239	351	443	590	681	723	815	927	1,018
19	249	365	461	614	709	751	847	963	1,058
20	259	379	479	638	737	779	879	999	1,098
21	269	393	497	662	765	807	911	1,035	1,138
22	279	407	515	686	793	835	943	1,071	1,178
23	289	421	533	710	821	863	975	1,107	1,218
24	299	435	551	734	849	891	1,007	1,143	1,258
25	314	456	578	770	891	933	1,055	1,197	1,318
26	324	470	596	794	919	961	1,087	1,233	1,358

TOP TREATMENTS: Rod Mount — Ring Top

Series numbers beyond what is listed in the charts below are available—please submit these quote requests via fax or email.

UNLINED — 2.5 FULLNESS — RING TOP

Series	Overall Finished Width								
	36"	54"	72"	90"	108"	126"	144"	162"	180"
07	105	153	209	258	293	320	355	404	438
08	120	173	239	293	333	360	400	454	493
09	132	189	263	321	365	392	436	494	537
10	144	205	287	349	397	424	472	534	581
11	156	221	311	377	429	456	508	574	625
12	168	237	335	405	461	488	544	614	669
13	180	253	359	433	493	520	580	654	713
14	192	269	383	461	525	552	616	694	757
15	204	285	407	489	557	584	652	734	801
16	216	301	431	517	589	616	688	774	845
17	228	317	455	545	621	648	724	814	889
18	240	333	479	573	653	680	760	854	933
19	252	349	503	601	685	712	796	894	977
20	264	365	527	629	717	744	832	934	1,021
21	276	381	551	657	749	776	868	974	1,065
22	288	397	575	685	781	808	904	1,014	1,109
23	300	413	599	713	813	840	940	1,054	1,153
24	312	429	623	741	845	872	976	1,094	1,197
25	330	453	659	783	893	920	1,030	1,154	1,263
26	342	469	683	811	925	952	1,066	1,194	1,307

LINED — 2.5 FULLNESS — RING TOP

Series	Overall Finished Width								
	36"	54"	72"	90"	108"	126"	144"	162"	180"
07	122	178	244	300	341	372	413	469	509
08	137	198	274	335	381	412	458	519	564
09	149	214	298	363	413	444	494	559	608
10	161	230	322	391	445	476	530	599	652
11	173	246	346	419	477	508	566	639	696
12	185	262	370	447	509	540	602	679	740
13	197	278	394	475	541	572	638	719	784
14	209	294	418	503	573	604	674	759	828
15	221	310	442	531	605	636	710	799	872
16	233	326	466	559	637	668	746	839	916
17	245	342	490	587	669	700	782	879	960
18	257	358	514	615	701	732	818	919	1,004
19	269	374	538	643	733	764	854	959	1,048
20	281	390	562	671	765	796	890	999	1,092
21	293	406	586	699	797	828	926	1,039	1,136
22	305	422	610	727	829	860	962	1,079	1,180
23	317	438	634	755	861	892	998	1,119	1,224
24	329	454	658	783	893	924	1,034	1,159	1,268
25	347	478	694	825	941	972	1,088	1,219	1,334
26	359	494	718	853	973	1,004	1,124	1,259	1,378

TOP TREATMENTS: Rod Mount — Rod Pocket

Series numbers beyond what is listed in the charts below are available—please submit these quote requests via fax or email.

UNLINED — 2.5 FULLNESS — ROD POCKET

Series	Overall Finished Width								
	36"	54"	72"	90"	108"	126"	144"	162"	180"
07	79	106	132	158	184	184	211	237	263
08	94	126	157	188	219	219	251	282	313
09	106	142	177	212	247	247	283	318	353
10	118	158	197	236	275	275	315	354	393
11	130	174	217	260	303	303	347	390	433
12	142	190	237	284	331	331	379	426	473
13	154	206	257	308	359	359	411	462	513
14	166	222	277	332	387	387	443	498	553
15	178	238	297	356	415	415	475	534	593
16	190	254	317	380	443	443	507	570	633
17	202	270	337	404	471	471	539	606	673
18	214	286	357	428	499	499	571	642	713
19	226	302	377	452	527	527	603	678	753
20	238	318	397	476	555	555	635	714	793
21	250	334	417	500	583	583	667	750	833
22	262	350	437	524	611	611	699	786	873
23	274	366	457	548	639	639	731	822	913
24	286	382	477	572	667	667	763	858	953
25	304	406	507	608	709	709	811	912	1,013
26	316	422	527	632	737	737	843	948	1,053

LINED — 2.5 FULLNESS — ROD POCKET

Series	Overall Finished Width								
	36"	54"	72"	90"	108"	126"	144"	162"	180"
07	95	126	157	189	220	220	251	283	314
08	110	146	182	219	255	255	291	328	364
09	122	162	202	243	283	283	323	364	404
10	134	178	222	267	311	311	355	400	444
11	146	194	242	291	339	339	387	436	484
12	158	210	262	315	367	367	419	472	524
13	170	226	282	339	395	395	451	508	564
14	182	242	302	363	423	423	483	544	604
15	194	258	322	387	451	451	515	580	644
16	206	274	342	411	479	479	547	616	684
17	218	290	362	435	507	507	579	652	724
18	230	306	382	459	535	535	611	688	764
19	242	322	402	483	563	563	643	724	804
20	254	338	422	507	591	591	675	760	844
21	266	354	442	531	619	619	707	796	884
22	278	370	462	555	647	647	739	832	924
23	290	386	482	579	675	675	771	868	964
24	302	402	502	603	703	703	803	904	1,004
25	320	426	532	639	745	745	851	958	1,064
26	332	442	552	663	773	773	883	994	1,104

TOP TREATMENTS: Board Mount Swags

Series numbers beyond what is listed in the charts below are available—please submit these quote requests via fax or email.

BELL SWAG VALANCE

Series	Swags								
	1	2	3	3	4	5	5	6	7
	Face Width in Inches								
	36"	54"	72"	90"	108"	126"	144"	162"	180"
07	327	489	632	795	916	1,079	1,200	1,363	1,463
08	357	529	687	860	991	1,164	1,295	1,468	1,573
09	381	561	731	912	1,051	1,232	1,371	1,552	1,661
10	405	593	775	964	1,111	1,300	1,447	1,636	1,749
11	429	625	819	1,016	1,171	1,368	1,523	1,720	1,837
12	453	657	863	1,068	1,231	1,436	1,599	1,804	1,925
13	477	689	907	1,120	1,291	1,504	1,675	1,888	2,013
14	501	721	951	1,172	1,351	1,572	1,751	1,972	2,101
15	525	753	995	1,224	1,411	1,640	1,827	2,056	2,189
16	549	785	1,039	1,276	1,471	1,708	1,903	2,140	2,277
17	573	817	1,083	1,328	1,531	1,776	1,979	2,224	2,365
18	597	849	1,127	1,380	1,591	1,844	2,055	2,308	2,453
19	621	881	1,171	1,432	1,651	1,912	2,131	2,392	2,541
20	645	913	1,215	1,484	1,711	1,980	2,207	2,476	2,629
21	669	945	1,259	1,536	1,771	2,048	2,283	2,560	2,717
22	693	977	1,303	1,588	1,831	2,116	2,359	2,644	2,805
23	717	1,009	1,347	1,640	1,891	2,184	2,435	2,728	2,893
24	741	1,041	1,391	1,692	1,951	2,252	2,511	2,812	2,981
25	777	1,089	1,457	1,770	2,041	2,354	2,625	2,938	3,113
26	801	1,121	1,501	1,822	2,101	2,422	2,701	3,022	3,201

TRADITIONAL SWAG — CASCADES UP TO 36"

Series	Swags						
	1	2	3	4	5	6	7
	Face Width in Inches						
	48"	72"	96"	120"	144"	168"	192"
07	441	665	909	1,132	1,353	1,576	1,821
08	471	705	964	1,197	1,433	1,666	1,926
09	495	737	1,008	1,249	1,497	1,738	2,010
10	519	769	1,052	1,301	1,561	1,810	2,094
11	543	801	1,096	1,353	1,625	1,882	2,178
12	567	833	1,140	1,405	1,689	1,954	2,262
13	591	865	1,184	1,457	1,753	2,026	2,346
14	615	897	1,228	1,509	1,817	2,098	2,430
15	639	929	1,272	1,561	1,881	2,170	2,514
16	663	961	1,316	1,613	1,945	2,242	2,598
17	687	993	1,360	1,665	2,009	2,314	2,682
18	711	1,025	1,404	1,717	2,073	2,386	2,766
19	735	1,057	1,448	1,769	2,137	2,458	2,850
20	759	1,089	1,492	1,821	2,201	2,530	2,934
21	783	1,121	1,536	1,873	2,265	2,602	3,018
22	807	1,153	1,580	1,925	2,329	2,674	3,102
23	831	1,185	1,624	1,977	2,393	2,746	3,186
24	855	1,217	1,668	2,029	2,457	2,818	3,270
25	891	1,265	1,734	2,107	2,553	2,926	3,396
26	915	1,297	1,778	2,159	2,617	2,998	3,480

TRADITIONAL SWAG — CASCADES UP TO 110"

Series	Swags						
	1	2	3	4	5	6	7
	Face Width in Inches						
	48"	72"	96"	120"	144"	168"	192"
07	630	833	1,077	1,300	1,521	1,744	1,989
08	705	913	1,172	1,405	1,641	1,874	2,134
09	765	977	1,248	1,489	1,737	1,978	2,250
10	825	1,041	1,324	1,573	1,833	2,082	2,366
11	885	1,105	1,400	1,657	1,929	2,186	2,482
12	945	1,169	1,476	1,741	2,025	2,290	2,598
13	1,005	1,233	1,552	1,825	2,121	2,394	2,714
14	1,065	1,297	1,628	1,909	2,217	2,498	2,830
15	1,125	1,361	1,704	1,993	2,313	2,602	2,946
16	1,185	1,425	1,780	2,077	2,409	2,706	3,062
17	1,245	1,489	1,856	2,161	2,505	2,810	3,178
18	1,305	1,553	1,932	2,245	2,601	2,914	3,294
19	1,365	1,617	2,008	2,329	2,697	3,018	3,410
20	1,425	1,681	2,084	2,413	2,793	3,122	3,526
21	1,485	1,745	2,160	2,497	2,889	3,226	3,642
22	1,545	1,809	2,236	2,581	2,985	3,330	3,758
23	1,605	1,873	2,312	2,665	3,081	3,434	3,874
24	1,665	1,937	2,388	2,749	3,177	3,538	3,990
25	1,755	2,033	2,502	2,875	3,321	3,694	4,164
26	1,815	2,097	2,578	2,959	3,417	3,798	4,280

TOP TREATMENTS: Rod Mount Swags

Series numbers beyond what is listed in the charts below are available—please submit these quote requests via fax or email.

ROUNDED SWAG				ROUNDED SWAG W/ CASCADE				POINTED BELL SWAG			
Series	Face Width in Inches			Series	Face Width in Inches			Series	Face Width in Inches		
	18"	25"	37"		18"	25"	37"		18"	25"	37"
07	135	181	248	07	294	357	441	07	220	267	314
08	145	191	263	08	334	397	486	08	250	297	344
09	153	199	275	09	366	429	522	09	274	321	368
10	161	207	287	10	398	461	558	10	298	345	392
11	169	215	299	11	430	493	594	11	322	369	416
12	177	223	311	12	462	525	630	12	346	393	440
13	185	231	323	13	494	557	666	13	370	417	464
14	193	239	335	14	526	589	702	14	394	441	488
15	201	247	347	15	558	621	738	15	418	465	512
16	209	255	359	16	590	653	774	16	442	489	536
17	217	263	371	17	622	685	810	17	466	513	560
18	225	271	383	18	654	717	846	18	490	537	584
19	233	279	395	19	686	749	882	19	514	561	608
20	241	287	407	20	718	781	918	20	538	585	632
21	249	295	419	21	750	813	954	21	562	609	656
22	257	303	431	22	782	845	990	22	586	633	680
23	265	311	443	23	814	877	1,026	23	610	657	704
24	273	319	455	24	846	909	1,062	24	634	681	728
25	285	331	473	25	894	957	1,116	25	670	717	764
26	293	339	485	26	926	989	1,152	26	694	741	788

POLE SWAG

Series	Swags					
	1	2	3	4	5	6
	Face Width in Inches					
	50"	92"	124"	156"	188"	220"
07	342	530	761	935	1,144	1,375
08	382	590	851	1,050	1,284	1,545
09	414	638	923	1,142	1,396	1,681
10	446	686	995	1,234	1,508	1,817
11	478	734	1,067	1,326	1,620	1,953
12	510	782	1,139	1,418	1,732	2,089
13	542	830	1,211	1,510	1,844	2,225
14	574	878	1,283	1,602	1,956	2,361
15	606	926	1,355	1,694	2,068	2,497
16	638	974	1,427	1,786	2,180	2,633
17	670	1,022	1,499	1,878	2,292	2,769
18	702	1,070	1,571	1,970	2,404	2,905
19	734	1,118	1,643	2,062	2,516	3,041
20	766	1,166	1,715	2,154	2,628	3,177
21	798	1,214	1,787	2,246	2,740	3,313
22	830	1,262	1,859	2,338	2,852	3,449
23	862	1,310	1,931	2,430	2,964	3,585
24	894	1,358	2,003	2,522	3,076	3,721
25	942	1,430	2,111	2,660	3,244	3,925
26	974	1,478	2,183	2,752	3,356	4,061

STRAIGHT TIEBACKS: Single

Width is flat width for a single tieback. Pricing is for a single tieback.

Series	Straight Plain			Straight Trim			Straight Corded		
	18	25	37	18	25	37	18	25	37
07	25	33	39	51	72	79	45	57	67
08	28	36	41	54	74	82	50	62	72
09	30	38	43	56	76	84	54	66	76
10	32	40	45	58	78	86	58	70	80
11	34	42	47	60	80	88	62	74	84
12	36	44	49	62	82	90	66	78	88
13	38	46	51	64	84	92	70	82	92
14	40	48	53	66	86	94	74	86	96
15	42	50	55	68	88	96	78	90	100
16	44	52	57	70	90	98	82	94	104
17	46	54	59	72	92	100	86	98	108
18	48	56	61	74	94	102	90	102	112
19	50	58	63	76	96	104	94	106	116
20	52	60	65	78	98	106	98	110	120
21	54	62	67	80	100	108	102	114	124
22	56	64	69	82	102	110	106	118	128
23	58	66	71	84	104	112	110	122	132
24	60	68	73	86	106	114	114	126	136
25	63	71	76	89	109	117	120	132	142
26	65	73	78	91	111	119	124	136	146

STRAIGHT TIEBACKS: Pair

Width is flat width for each tieback. Pricing is for a pair of tiebacks.

Series	Straight Plain			Straight Trim			Straight Corded		
	18	25	37	18	25	37	18	25	37
07	40	66	77	81	132	158	68	103	122
08	42	71	82	83	137	163	73	111	130
09	44	75	86	85	141	167	77	117	136
10	46	79	90	87	145	171	81	123	142
11	48	83	94	89	149	175	85	129	148
12	50	87	98	91	153	179	89	135	154
13	52	91	102	93	157	183	93	141	160
14	54	95	106	95	161	187	97	147	166
15	56	99	110	97	165	191	101	153	172
16	58	103	114	99	169	195	105	159	178
17	60	107	118	101	173	199	109	165	184
18	62	111	122	103	177	203	113	171	190
19	64	115	126	105	181	207	117	177	196
20	66	119	130	107	185	211	121	183	202
21	68	123	134	109	189	215	125	189	208
22	70	127	138	111	193	219	129	195	214
23	72	131	142	113	197	223	133	201	220
24	74	135	146	115	201	227	137	207	226
25	77	141	152	118	207	233	143	216	235
26	79	145	156	120	211	237	147	222	241

TAPERED TIEBACKS: Single

Width is flat width for a single tieback. Pricing is for a single tieback.

Series	Tapered Plain			Tapered Trim			Tapered Corded		
	18	25	37	18	25	37	18	25	37
07	27	35	42	53	74	93	50	65	76
08	29	38	44	56	77	96	55	70	81
09	31	40	46	58	79	98	59	74	85
10	33	42	48	60	81	100	63	78	89
11	35	44	50	62	83	102	67	82	93
12	37	46	52	64	85	104	71	86	97
13	39	48	54	66	87	106	75	90	101
14	41	50	56	68	89	108	79	94	105
15	43	52	58	70	91	110	83	98	109
16	45	54	60	72	93	112	87	102	113
17	47	56	62	74	95	114	91	106	117
18	49	58	64	76	97	116	95	110	121
19	51	60	66	78	99	118	99	114	125
20	53	62	68	80	101	120	103	118	129
21	55	64	70	82	103	122	107	122	133
22	57	66	72	84	105	124	111	126	137
23	59	68	74	86	107	126	115	130	141
24	61	70	76	88	109	128	119	134	145
25	64	73	79	91	112	131	125	140	151
26	66	75	81	93	114	133	129	144	155

TAPERED TIEBACKS: Pair

Width is flat width for each tieback. Pricing is for a pair of tiebacks.

Series	Tapered Plain			Tapered Trim			Tapered Corded		
	Flat Width			Flat Width			Flat Width		
	18	25	37	18	25	37	18	25	37
07	43	70	83	95	148	176	78	119	141
08	45	75	88	98	153	181	83	126	149
09	47	79	92	100	157	185	87	132	155
10	49	83	96	102	161	189	91	138	161
11	51	87	100	104	165	193	95	144	167
12	53	91	104	106	169	197	99	150	173
13	55	95	108	108	173	201	103	156	179
14	57	99	112	110	177	205	107	162	185
15	59	103	116	112	181	209	111	168	191
16	61	107	120	114	185	213	115	174	197
17	63	111	124	116	189	217	119	180	203
18	65	115	128	118	193	221	123	186	209
19	67	119	132	120	197	225	127	192	215
20	69	123	136	122	201	229	131	198	221
21	71	127	140	124	205	233	135	204	227
22	73	131	144	126	209	237	139	210	233
23	75	135	148	128	213	241	143	216	239
24	77	139	152	130	217	245	147	222	245
25	80	145	158	133	223	251	153	231	254
26	82	149	162	135	227	255	157	237	260

CONTOURED TIEBACKS: Single

Width is flat width for a single tieback. Pricing is for a single tieback.

Series	Contoured Plain			Contoured Trim			Contoured Corded		
	Flat Width			Flat Width			Flat Width		
	18	25	37	18	25	37	18	25	37
07	27	35	42	53	74	93	50	65	76
08	29	38	44	56	77	96	55	70	81
09	31	40	46	58	79	98	59	74	85
10	33	42	48	60	81	100	63	78	89
11	35	44	50	62	83	102	67	82	93
12	37	46	52	64	85	104	71	86	97
13	39	48	54	66	87	106	75	90	101
14	41	50	56	68	89	108	79	94	105
15	43	52	58	70	91	110	83	98	109
16	45	54	60	72	93	112	87	102	113
17	47	56	62	74	95	114	91	106	117
18	49	58	64	76	97	116	95	110	121
19	51	60	66	78	99	118	99	114	125
20	53	62	68	80	101	120	103	118	129
21	55	64	70	82	103	122	107	122	133
22	57	66	72	84	105	124	111	126	137
23	59	68	74	86	107	126	115	130	141
24	61	70	76	88	109	128	119	134	145
25	64	73	79	91	112	131	125	140	151
26	66	75	81	93	114	133	129	144	155

CONTOURED TIEBACKS: Pair

Width is flat width for each tieback. Pricing is for a pair of tiebacks.

Series	Contoured Plain			Contoured Trim			Contoured Corded		
	Flat Width			Flat Width			Flat Width		
	18	25	37	18	25	37	18	25	37
07	43	70	83	95	148	176	89	129	152
08	45	75	88	98	153	181	96	139	162
09	47	79	92	100	157	185	102	147	170
10	49	83	96	102	161	189	108	155	178
11	51	87	100	104	165	193	114	163	186
12	53	91	104	106	169	197	120	171	194
13	55	95	108	108	173	201	126	179	202
14	57	99	112	110	177	205	132	187	210
15	59	103	116	112	181	209	138	195	218
16	61	107	120	114	185	213	144	203	226
17	63	111	124	116	189	217	150	211	234
18	65	115	128	118	193	221	156	219	242
19	67	119	132	120	197	225	162	227	250
20	69	123	136	122	201	229	168	235	258
21	71	127	140	124	205	233	174	243	266
22	73	131	144	126	209	237	180	251	274
23	75	135	148	128	213	241	186	259	282
24	77	139	152	130	217	245	192	267	290
25	80	145	158	133	223	251	201	279	302
26	82	149	162	135	227	255	207	287	310

RIPPLEFOLD: 60% Fullness — Unlined

Pricing for butt or overlap master panels with 4" hem (additional charge for larger hems). Sizes and series numbers beyond what is listed below are available—please submit these quote requests via fax or email.

Series	Length	Finished Pair or Panel Width												
		36"	48"	60"	72"	84"	96"	108"	120"	132"	144"	156"	168"	180"
07	36	145	168	211	234	257	300	323	366	390	401	456	479	491
07	48	166	189	242	265	289	342	365	419	442	454	519	542	554
07	72	187	210	274	297	320	384	407	471	495	506	582	605	617
07	84	208	231	305	328	352	426	449	524	547	559	645	668	680
07	108	229	252	337	360	383	468	491	576	600	611	708	731	743
07	120	250	273	368	391	415	510	533	629	652	664	771	794	806
07	144	271	294	400	423	446	552	575	681	705	716	834	857	869
08	36	160	183	233	256	280	330	353	404	427	439	501	524	536
08	48	186	209	272	295	319	382	405	469	492	504	579	602	614
08	72	212	235	311	334	358	434	457	534	557	569	657	680	692
08	84	238	261	350	373	397	486	509	599	622	634	735	758	770
08	108	264	287	389	412	436	538	561	664	687	699	813	836	848
08	120	290	313	428	451	475	590	613	729	752	764	891	914	926
08	144	316	339	467	490	514	642	665	794	817	829	969	992	1,004
09	36	172	195	251	274	298	354	377	434	457	469	537	560	572
09	48	202	225	296	319	343	414	437	509	532	544	627	650	662
09	72	232	255	341	364	388	474	497	584	607	619	717	740	752
09	84	262	285	386	409	433	534	557	659	682	694	807	830	842
09	108	292	315	431	454	478	594	617	734	757	769	897	920	932
09	120	322	345	476	499	523	654	677	809	832	844	987	1,010	1,022
09	144	352	375	521	544	568	714	737	884	907	919	1,077	1,100	1,112
10	36	184	207	269	292	316	378	401	464	487	499	573	596	608
10	48	218	241	320	343	367	446	469	549	572	584	675	698	710
10	72	252	275	371	394	418	514	537	634	657	669	777	800	812
10	84	286	309	422	445	469	582	605	719	742	754	879	902	914
10	108	320	343	473	496	520	650	673	804	827	839	981	1,004	1,016
10	120	354	377	524	547	571	718	741	889	912	924	1,083	1,106	1,118
10	144	388	411	575	598	622	786	809	974	997	1,009	1,185	1,208	1,220
11	36	196	219	287	310	334	402	425	494	517	529	609	632	644
11	48	234	257	344	367	391	478	501	589	612	624	723	746	758
11	72	272	295	401	424	448	554	577	684	707	719	837	860	872
11	84	310	333	458	481	505	630	653	779	802	814	951	974	986
11	108	348	371	515	538	562	706	729	874	897	909	1,065	1,088	1,100
11	120	386	409	572	595	619	782	805	969	992	1,004	1,179	1,202	1,214
11	144	424	447	629	652	676	858	881	1,064	1,087	1,099	1,293	1,316	1,328
12	36	208	231	305	328	352	426	449	524	547	559	645	668	680
12	48	250	273	368	391	415	510	533	629	652	664	771	794	806
12	72	292	315	431	454	478	594	617	734	757	769	897	920	932
12	84	334	357	494	517	541	678	701	839	862	874	1,023	1,046	1,058
12	108	376	399	557	580	604	762	785	944	967	979	1,149	1,172	1,184
12	120	418	441	620	643	667	846	869	1,049	1,072	1,084	1,275	1,298	1,310
12	144	460	483	683	706	730	930	953	1,154	1,177	1,189	1,401	1,424	1,436
13	36	220	243	323	346	370	450	473	554	577	589	681	704	716
13	48	266	289	392	415	439	542	565	669	692	704	819	842	854
13	72	312	335	461	484	508	634	657	784	807	819	957	980	992
13	84	358	381	530	553	577	726	749	899	922	934	1,095	1,118	1,130
13	108	404	427	599	622	646	818	841	1,014	1,037	1,049	1,233	1,256	1,268
13	120	450	473	668	691	715	910	933	1,129	1,152	1,164	1,371	1,394	1,406
13	144	496	519	737	760	784	1,002	1,025	1,244	1,267	1,279	1,509	1,532	1,544
14	36	232	255	341	364	388	474	497	584	607	619	717	740	752
14	48	282	305	416	439	463	574	597	709	732	744	867	890	902
14	72	332	355	491	514	538	674	697	834	857	869	1,017	1,040	1,052
14	84	382	405	566	589	613	774	797	959	982	994	1,167	1,190	1,202
14	108	432	455	641	664	688	874	897	1,084	1,107	1,119	1,317	1,340	1,352
14	120	482	505	716	739	763	974	997	1,209	1,232	1,244	1,467	1,490	1,502
14	144	532	555	791	814	838	1,074	1,097	1,334	1,357	1,369	1,617	1,640	1,652
15	36	244	267	359	382	406	498	521	614	637	649	753	776	788
15	48	298	321	440	463	487	606	629	749	772	784	915	938	950
15	72	352	375	521	544	568	714	737	884	907	919	1,077	1,100	1,112
15	84	406	429	602	625	649	822	845	1,019	1,042	1,054	1,239	1,262	1,274
15	108	460	483	683	706	730	930	953	1,154	1,177	1,189	1,401	1,424	1,436
15	120	514	537	764	787	811	1,038	1,061	1,289	1,312	1,324	1,563	1,586	1,598
15	144	568	591	845	868	892	1,146	1,169	1,424	1,447	1,459	1,725	1,748	1,760
16	36	256	279	377	400	424	522	545	644	667	679	789	812	824
16	48	314	337	464	487	511	638	661	789	812	824	963	986	998
16	72	372	395	551	574	598	754	777	934	957	969	1,137	1,160	1,172
16	84	430	453	638	661	685	870	893	1,079	1,102	1,114	1,311	1,334	1,346
16	108	488	511	725	748	772	986	1,009	1,224	1,247	1,259	1,485	1,508	1,520
16	120	546	569	812	835	859	1,102	1,125	1,369	1,392	1,404	1,659	1,682	1,694
16	144	604	627	899	922	946	1,218	1,241	1,514	1,537	1,549	1,833	1,856	1,868

RIPPLEFOLD: 60% Fullness — Unlined

Pricing for butt or overlap master panels with 4" hem (additional charge for larger hems). Sizes and series numbers beyond what is listed below are available—please submit these quote requests via fax or email.

Series	Length	Finished Pair or Panel Width													
		36"	48"	60"	72"	84"	96"	108"	120"	132"	144"	156"	168"	180"	
17	36	268	291	395	418	442	546	569	674	697	709	825	848	860	
17	48	330	353	488	511	535	670	693	829	852	864	1,011	1,034	1,046	
17	72	392	415	581	604	628	794	817	984	1,007	1,019	1,197	1,220	1,232	
17	84	454	477	674	697	721	918	941	1,139	1,162	1,174	1,383	1,406	1,418	
17	108	516	539	767	790	814	1,042	1,065	1,294	1,317	1,329	1,569	1,592	1,604	
17	120	578	601	860	883	907	1,166	1,189	1,449	1,472	1,484	1,755	1,778	1,790	
17	144	640	663	953	976	1,000	1,290	1,313	1,604	1,627	1,639	1,941	1,964	1,976	
18	36	280	303	413	436	460	570	593	704	727	739	861	884	896	
18	48	346	369	512	535	559	702	725	869	892	904	1,059	1,082	1,094	
18	72	412	435	611	634	658	834	857	1,034	1,057	1,069	1,257	1,280	1,292	
18	84	478	501	710	733	757	966	989	1,199	1,222	1,234	1,455	1,478	1,490	
18	108	544	567	809	832	856	1,098	1,121	1,364	1,387	1,399	1,653	1,676	1,688	
18	120	610	633	908	931	955	1,230	1,253	1,529	1,552	1,564	1,851	1,874	1,886	
18	144	676	699	1,007	1,030	1,054	1,362	1,385	1,694	1,717	1,729	2,049	2,072	2,084	
19	36	292	315	431	454	478	594	617	734	757	769	897	920	932	
19	48	362	385	536	559	583	734	757	909	932	944	1,107	1,130	1,142	
19	72	432	455	641	664	688	874	897	1,084	1,107	1,119	1,317	1,340	1,352	
19	84	502	525	746	769	793	1,014	1,037	1,259	1,282	1,294	1,527	1,550	1,562	
19	108	572	595	851	874	898	1,154	1,177	1,434	1,457	1,469	1,737	1,760	1,772	
19	120	642	665	956	979	1,003	1,294	1,317	1,609	1,632	1,644	1,947	1,970	1,982	
19	144	712	735	1,061	1,084	1,108	1,434	1,457	1,784	1,807	1,819	2,157	2,180	2,192	
20	36	304	327	449	472	496	618	641	764	787	799	933	956	968	
20	48	378	401	560	583	607	766	789	949	972	984	1,155	1,178	1,190	
20	72	452	475	671	694	718	914	937	1,134	1,157	1,169	1,377	1,400	1,412	
20	84	526	549	782	805	829	1,062	1,085	1,319	1,342	1,354	1,599	1,622	1,634	
20	108	600	623	893	916	940	1,210	1,233	1,504	1,527	1,539	1,821	1,844	1,856	
20	120	674	697	1,004	1,027	1,051	1,358	1,381	1,689	1,712	1,724	2,043	2,066	2,078	
20	144	748	771	1,115	1,138	1,162	1,506	1,529	1,874	1,897	1,909	2,265	2,288	2,300	
21	36	316	339	467	490	514	642	665	794	817	829	969	992	1,004	
21	48	394	417	584	607	631	798	821	989	1,012	1,024	1,203	1,226	1,238	
21	72	472	495	701	724	748	954	977	1,184	1,207	1,219	1,437	1,460	1,472	
21	84	550	573	818	841	865	1,110	1,133	1,379	1,402	1,414	1,671	1,694	1,706	
21	108	628	651	935	958	982	1,266	1,289	1,574	1,597	1,609	1,905	1,928	1,940	
21	120	706	729	1,052	1,075	1,099	1,422	1,445	1,769	1,792	1,804	2,139	2,162	2,174	
21	144	784	807	1,169	1,192	1,216	1,578	1,601	1,964	1,987	1,999	2,373	2,396	2,408	
22	36	328	351	485	508	532	666	689	824	847	859	1,005	1,028	1,040	
22	48	410	433	608	631	655	830	853	1,029	1,052	1,064	1,251	1,274	1,286	
22	72	492	515	731	754	778	994	1,017	1,234	1,257	1,269	1,497	1,520	1,532	
22	84	574	597	854	877	901	1,158	1,181	1,439	1,462	1,474	1,743	1,766	1,778	
22	108	656	679	977	1,000	1,024	1,322	1,345	1,644	1,667	1,679	1,989	2,012	2,024	
22	120	738	761	1,100	1,123	1,147	1,486	1,509	1,849	1,872	1,884	2,235	2,258	2,270	
22	144	820	843	1,223	1,246	1,270	1,650	1,673	2,054	2,077	2,089	2,481	2,504	2,516	
23	36	340	363	503	526	550	690	713	854	877	889	1,041	1,064	1,076	
23	48	426	449	632	655	679	862	885	1,069	1,092	1,104	1,299	1,322	1,334	
23	72	512	535	761	784	808	1,034	1,057	1,284	1,307	1,319	1,557	1,580	1,592	
23	84	598	621	890	913	937	1,206	1,229	1,499	1,522	1,534	1,815	1,838	1,850	
23	108	684	707	1,019	1,042	1,066	1,378	1,401	1,714	1,737	1,749	2,073	2,096	2,108	
23	120	770	793	1,148	1,171	1,195	1,550	1,573	1,929	1,952	1,964	2,331	2,354	2,366	
23	144	856	879	1,277	1,300	1,324	1,722	1,745	2,144	2,167	2,179	2,589	2,612	2,624	
24	36	352	375	521	544	568	714	737	884	907	919	1,077	1,100	1,112	
24	48	442	465	656	679	703	894	917	1,109	1,132	1,144	1,347	1,370	1,382	
24	72	532	555	791	814	838	1,074	1,097	1,334	1,357	1,369	1,617	1,640	1,652	
24	84	622	645	926	949	973	1,254	1,277	1,559	1,582	1,594	1,887	1,910	1,922	
24	108	712	735	1,061	1,084	1,108	1,434	1,457	1,784	1,807	1,819	2,157	2,180	2,192	
24	120	802	825	1,196	1,219	1,243	1,614	1,637	2,009	2,032	2,044	2,427	2,450	2,462	
24	144	892	915	1,331	1,354	1,378	1,794	1,817	2,234	2,257	2,269	2,697	2,720	2,732	
25	36	370	393	548	571	595	750	773	929	952	964	1,131	1,154	1,166	
25	48	466	489	692	715	739	942	965	1,169	1,192	1,204	1,419	1,442	1,454	
25	72	562	585	836	859	883	1,134	1,157	1,409	1,432	1,444	1,707	1,730	1,742	
25	84	658	681	980	1,003	1,027	1,326	1,349	1,649	1,672	1,684	1,995	2,018	2,030	
25	108	754	777	1,124	1,147	1,171	1,518	1,541	1,889	1,912	1,924	2,283	2,306	2,318	
25	120	850	873	1,268	1,291	1,315	1,710	1,733	2,129	2,152	2,164	2,571	2,594	2,606	
25	144	946	969	1,412	1,435	1,459	1,902	1,925	2,369	2,392	2,404	2,859	2,882	2,894	
26	36	382	405	566	589	613	774	797	959	982	994	1,167	1,190	1,202	
26	48	482	505	716	739	763	974	997	1,209	1,232	1,244	1,467	1,490	1,502	
26	72	582	605	866	889	913	1,174	1,197	1,459	1,482	1,494	1,767	1,790	1,802	
26	84	682	705	1,016	1,039	1,063	1,374	1,397	1,709	1,732	1,744	2,067	2,090	2,102	
26	108	782	805	1,166	1,189	1,213	1,574	1,597	1,959	1,982	1,994	2,367	2,390	2,402	
26	120	882	905	1,316	1,339	1,363	1,774	1,797	2,209	2,232	2,244	2,667	2,690	2,702	
26	144	982	1,005	1,466	1,489	1,513	1,974	1,997	2,459	2,482	2,494	2,967	2,990	3,002	

RIPPLEFOLD: 60% Fullness — Lined (Lining 01000)

Pricing for butt or overlap master panels with 4" hem (additional charge for larger hems). Sizes and series numbers beyond what is listed below are available—please submit these quote requests via fax or email.

Series	Length	Finished Pair or Panel Width												
		36"	48"	60"	72"	84"	96"	108"	120"	132"	144"	156"	168"	180"
07	36	249	277	352	379	437	482	539	584	642	655	744	801	815
07	48	270	298	383	411	468	524	581	637	694	708	807	864	878
07	60	270	298	383	411	468	524	581	637	694	708	807	864	878
07	72	291	319	415	442	500	566	623	689	747	760	870	927	941
07	84	312	340	446	474	531	608	665	742	799	813	933	990	1,004
07	96	312	340	446	474	531	608	665	742	799	813	933	990	1,004
07	101	333	361	478	505	563	650	707	794	852	865	996	1,053	1,067
08	36	264	292	374	402	459	512	569	622	679	693	789	846	860
08	48	290	318	413	441	498	564	621	687	744	758	867	924	938
08	60	290	318	413	441	498	564	621	687	744	758	867	924	938
08	72	316	344	452	480	537	616	673	752	809	823	945	1,002	1,016
08	84	342	370	491	519	576	668	725	817	874	888	1,023	1,080	1,094
08	96	342	370	491	519	576	668	725	817	874	888	1,023	1,080	1,094
08	101	368	396	530	558	615	720	777	882	939	953	1,101	1,158	1,172
09	36	276	304	392	420	477	536	593	652	709	723	825	882	896
09	48	306	334	437	465	522	596	653	727	784	798	915	972	986
09	60	306	334	437	465	522	596	653	727	784	798	915	972	986
09	72	336	364	482	510	567	656	713	802	859	873	1,005	1,062	1,076
09	84	366	394	527	555	612	716	773	877	934	948	1,095	1,152	1,166
09	96	366	394	527	555	612	716	773	877	934	948	1,095	1,152	1,166
09	101	396	424	572	600	657	776	833	952	1,009	1,023	1,185	1,242	1,256
10	36	288	316	410	438	495	560	617	682	739	753	861	918	932
10	48	322	350	461	489	546	628	685	767	824	838	963	1,020	1,034
10	60	322	350	461	489	546	628	685	767	824	838	963	1,020	1,034
10	72	356	384	512	540	597	696	753	852	909	923	1,065	1,122	1,136
10	84	390	418	563	591	648	764	821	937	994	1,008	1,167	1,224	1,238
10	96	390	418	563	591	648	764	821	937	994	1,008	1,167	1,224	1,238
10	101	424	452	614	642	699	832	889	1,022	1,079	1,093	1,269	1,326	1,340
11	36	300	328	428	456	513	584	641	712	769	783	897	954	968
11	48	338	366	485	513	570	660	717	807	864	878	1,011	1,068	1,082
11	60	338	366	485	513	570	660	717	807	864	878	1,011	1,068	1,082
11	72	376	404	542	570	627	736	793	902	959	973	1,125	1,182	1,196
11	84	414	442	599	627	684	812	869	997	1,054	1,068	1,239	1,296	1,310
11	96	414	442	599	627	684	812	869	997	1,054	1,068	1,239	1,296	1,310
11	101	452	480	656	684	741	888	945	1,092	1,149	1,163	1,353	1,410	1,424
12	36	312	340	446	474	531	608	665	742	799	813	933	990	1,004
12	48	354	382	509	537	594	692	749	847	904	918	1,059	1,116	1,130
12	60	354	382	509	537	594	692	749	847	904	918	1,059	1,116	1,130
12	72	396	424	572	600	657	776	833	952	1,009	1,023	1,185	1,242	1,256
12	84	438	466	635	663	720	860	917	1,057	1,114	1,128	1,311	1,368	1,382
12	96	438	466	635	663	720	860	917	1,057	1,114	1,128	1,311	1,368	1,382
12	101	480	508	698	726	783	944	1,001	1,162	1,219	1,233	1,437	1,494	1,508
13	36	324	352	464	492	549	632	689	772	829	843	969	1,026	1,040
13	48	370	398	533	561	618	724	781	887	944	958	1,107	1,164	1,178
13	60	370	398	533	561	618	724	781	887	944	958	1,107	1,164	1,178
13	72	416	444	602	630	687	816	873	1,002	1,059	1,073	1,245	1,302	1,316
13	84	462	490	671	699	756	908	965	1,117	1,174	1,188	1,383	1,440	1,454
13	96	462	490	671	699	756	908	965	1,117	1,174	1,188	1,383	1,440	1,454
13	101	508	536	740	768	825	1,000	1,057	1,232	1,289	1,303	1,521	1,578	1,592
14	36	336	364	482	510	567	656	713	802	859	873	1,005	1,062	1,076
14	48	386	414	557	585	642	756	813	927	984	998	1,155	1,212	1,226
14	60	386	414	557	585	642	756	813	927	984	998	1,155	1,212	1,226
14	72	436	464	632	660	717	856	913	1,052	1,109	1,123	1,305	1,362	1,376
14	84	486	514	707	735	792	956	1,013	1,177	1,234	1,248	1,455	1,512	1,526
14	96	486	514	707	735	792	956	1,013	1,177	1,234	1,248	1,455	1,512	1,526
14	101	536	564	782	810	867	1,056	1,113	1,302	1,359	1,373	1,605	1,662	1,676
15	36	348	376	500	528	585	680	737	832	889	903	1,041	1,098	1,112
15	48	402	430	581	609	666	788	845	967	1,024	1,038	1,203	1,260	1,274
15	60	402	430	581	609	666	788	845	967	1,024	1,038	1,203	1,260	1,274
15	72	456	484	662	690	747	896	953	1,102	1,159	1,173	1,365	1,422	1,436
15	84	510	538	743	771	828	1,004	1,061	1,237	1,294	1,308	1,527	1,584	1,598
15	96	510	538	743	771	828	1,004	1,061	1,237	1,294	1,308	1,527	1,584	1,598
15	101	564	592	824	852	909	1,112	1,169	1,372	1,429	1,443	1,689	1,746	1,760
16	36	360	388	518	546	603	704	761	862	919	933	1,077	1,134	1,148
16	48	418	446	605	633	690	820	877	1,007	1,064	1,078	1,251	1,308	1,322
16	60	418	446	605	633	690	820	877	1,007	1,064	1,078	1,251	1,308	1,322
16	72	476	504	692	720	777	936	993	1,152	1,209	1,223	1,425	1,482	1,496
16	84	534	562	779	807	864	1,052	1,109	1,297	1,354	1,368	1,599	1,656	1,670
16	96	534	562	779	807	864	1,052	1,109	1,297	1,354	1,368	1,599	1,656	1,670
16	101	592	620	866	894	951	1,168	1,225	1,442	1,499	1,513	1,773	1,830	1,844

RIPPLEFOLD: 60% Fullness — Lined (Lining 01000)

Pricing for butt or overlap master panels with 4" hem (additional charge for larger hems). Sizes and series numbers beyond what is listed below are available—please submit these quote requests via fax or email.

Series	Length	Finished Pair or Panel Width												
		36"	48"	60"	72"	84"	96"	108"	120"	132"	144"	156"	168"	180"
17	36	372	400	536	564	621	728	785	892	949	963	1,113	1,170	1,184
17	48	434	462	629	657	714	852	909	1,047	1,104	1,118	1,299	1,356	1,370
17	60	434	462	629	657	714	852	909	1,047	1,104	1,118	1,299	1,356	1,370
17	72	496	524	722	750	807	976	1,033	1,202	1,259	1,273	1,485	1,542	1,556
17	84	558	586	815	843	900	1,100	1,157	1,357	1,414	1,428	1,671	1,728	1,742
17	96	558	586	815	843	900	1,100	1,157	1,357	1,414	1,428	1,671	1,728	1,742
17	101	620	648	908	936	993	1,224	1,281	1,512	1,569	1,583	1,857	1,914	1,928
18	36	384	412	554	582	639	752	809	922	979	993	1,149	1,206	1,220
18	48	450	478	653	681	738	884	941	1,087	1,144	1,158	1,347	1,404	1,418
18	60	450	478	653	681	738	884	941	1,087	1,144	1,158	1,347	1,404	1,418
18	72	516	544	752	780	837	1,016	1,073	1,252	1,309	1,323	1,545	1,602	1,616
18	84	582	610	851	879	936	1,148	1,205	1,417	1,474	1,488	1,743	1,800	1,814
18	96	582	610	851	879	936	1,148	1,205	1,417	1,474	1,488	1,743	1,800	1,814
18	101	648	676	950	978	1,035	1,280	1,337	1,582	1,639	1,653	1,941	1,998	2,012
19	36	396	424	572	600	657	776	833	952	1,009	1,023	1,185	1,242	1,256
19	48	466	494	677	705	762	916	973	1,127	1,184	1,198	1,395	1,452	1,466
19	60	466	494	677	705	762	916	973	1,127	1,184	1,198	1,395	1,452	1,466
19	72	536	564	782	810	867	1,056	1,113	1,302	1,359	1,373	1,605	1,662	1,676
19	84	606	634	887	915	972	1,196	1,253	1,477	1,534	1,548	1,815	1,872	1,886
19	96	606	634	887	915	972	1,196	1,253	1,477	1,534	1,548	1,815	1,872	1,886
19	101	676	704	992	1,020	1,077	1,336	1,393	1,652	1,709	1,723	2,025	2,082	2,096
20	36	408	436	590	618	675	800	857	982	1,039	1,053	1,221	1,278	1,292
20	48	482	510	701	729	786	948	1,005	1,167	1,224	1,238	1,443	1,500	1,514
20	60	482	510	701	729	786	948	1,005	1,167	1,224	1,238	1,443	1,500	1,514
20	72	556	584	812	840	897	1,096	1,153	1,352	1,409	1,423	1,665	1,722	1,736
20	84	630	658	923	951	1,008	1,244	1,301	1,537	1,594	1,608	1,887	1,944	1,958
20	96	630	658	923	951	1,008	1,244	1,301	1,537	1,594	1,608	1,887	1,944	1,958
20	101	704	732	1,034	1,062	1,119	1,392	1,449	1,722	1,779	1,793	2,109	2,166	2,180
21	36	420	448	608	636	693	824	881	1,012	1,069	1,083	1,257	1,314	1,328
21	48	498	526	725	753	810	980	1,037	1,207	1,264	1,278	1,491	1,548	1,562
21	60	498	526	725	753	810	980	1,037	1,207	1,264	1,278	1,491	1,548	1,562
21	72	576	604	842	870	927	1,136	1,193	1,402	1,459	1,473	1,725	1,782	1,796
21	84	654	682	959	987	1,044	1,292	1,349	1,597	1,654	1,668	1,959	2,016	2,030
21	96	654	682	959	987	1,044	1,292	1,349	1,597	1,654	1,668	1,959	2,016	2,030
21	101	732	760	1,076	1,104	1,161	1,448	1,505	1,792	1,849	1,863	2,193	2,250	2,264
22	36	432	460	626	654	711	848	905	1,042	1,099	1,113	1,293	1,350	1,364
22	48	514	542	749	777	834	1,012	1,069	1,247	1,304	1,318	1,539	1,596	1,610
22	60	514	542	749	777	834	1,012	1,069	1,247	1,304	1,318	1,539	1,596	1,610
22	72	596	624	872	900	957	1,176	1,233	1,452	1,509	1,523	1,785	1,842	1,856
22	84	678	706	995	1,023	1,080	1,340	1,397	1,657	1,714	1,728	2,031	2,088	2,102
22	96	678	706	995	1,023	1,080	1,340	1,397	1,657	1,714	1,728	2,031	2,088	2,102
22	101	760	788	1,118	1,146	1,203	1,504	1,561	1,862	1,919	1,933	2,277	2,334	2,348
23	36	444	472	644	672	729	872	929	1,072	1,129	1,143	1,329	1,386	1,400
23	48	530	558	773	801	858	1,044	1,101	1,287	1,344	1,358	1,587	1,644	1,658
23	60	530	558	773	801	858	1,044	1,101	1,287	1,344	1,358	1,587	1,644	1,658
23	72	616	644	902	930	987	1,216	1,273	1,502	1,559	1,573	1,845	1,902	1,916
23	84	702	730	1,031	1,059	1,116	1,388	1,445	1,717	1,774	1,788	2,103	2,160	2,174
23	96	702	730	1,031	1,059	1,116	1,388	1,445	1,717	1,774	1,788	2,103	2,160	2,174
23	101	788	816	1,160	1,188	1,245	1,560	1,617	1,932	1,989	2,003	2,361	2,418	2,432
24	36	456	484	662	690	747	896	953	1,102	1,159	1,173	1,365	1,422	1,436
24	48	546	574	797	825	882	1,076	1,133	1,327	1,384	1,398	1,635	1,692	1,706
24	60	546	574	797	825	882	1,076	1,133	1,327	1,384	1,398	1,635	1,692	1,706
24	72	636	664	932	960	1,017	1,256	1,313	1,552	1,609	1,623	1,905	1,962	1,976
24	84	726	754	1,067	1,095	1,152	1,436	1,493	1,777	1,834	1,848	2,175	2,232	2,246
24	96	726	754	1,067	1,095	1,152	1,436	1,493	1,777	1,834	1,848	2,175	2,232	2,246
24	101	816	844	1,202	1,230	1,287	1,616	1,673	2,002	2,059	2,073	2,445	2,502	2,516
25	36	474	502	689	717	774	932	989	1,147	1,204	1,218	1,419	1,476	1,490
25	48	570	598	833	861	918	1,124	1,181	1,387	1,444	1,458	1,707	1,764	1,778
25	60	570	598	833	861	918	1,124	1,181	1,387	1,444	1,458	1,707	1,764	1,778
25	72	666	694	977	1,005	1,062	1,316	1,373	1,627	1,684	1,698	1,995	2,052	2,066
25	84	762	790	1,121	1,149	1,206	1,508	1,565	1,867	1,924	1,938	2,283	2,340	2,354
25	96	762	790	1,121	1,149	1,206	1,508	1,565	1,867	1,924	1,938	2,283	2,340	2,354
25	101	858	886	1,265	1,293	1,350	1,700	1,757	2,107	2,164	2,178	2,571	2,628	2,642
26	36	486	514	707	735	792	956	1,013	1,177	1,234	1,248	1,455	1,512	1,526
26	48	586	614	857	885	942	1,156	1,213	1,427	1,484	1,498	1,755	1,812	1,826
26	60	586	614	857	885	942	1,156	1,213	1,427	1,484	1,498	1,755	1,812	1,826
26	72	686	714	1,007	1,035	1,092	1,356	1,413	1,677	1,734	1,748	2,055	2,112	2,126
26	84	786	814	1,157	1,185	1,242	1,556	1,613	1,927	1,984	1,998	2,355	2,412	2,426
26	96	786	814	1,157	1,185	1,242	1,556	1,613	1,927	1,984	1,998	2,355	2,412	2,426
26	101	886	914	1,307	1,335	1,392	1,756	1,813	2,177	2,234	2,248	2,655	2,712	2,726

RIPPLEFOLD: 80% Fullness — Unlined

Pricing for butt or overlap master panels with 4" hem (additional charge for larger hems). Sizes and series numbers beyond what is listed below are available—please submit these quote requests via fax or email.

Series	Length	Finished Pair or Panel Width												
		36"	48"	60"	72"	84"	96"	108"	120"	132"	144"	156"	168"	180"
07	36	156	168	222	246	300	312	366	390	413	456	491	502	557
07	48	177	189	254	277	342	354	419	442	465	519	554	565	630
07	72	198	210	285	309	384	396	471	495	518	582	617	628	704
07	84	219	231	317	340	426	438	524	547	570	645	680	691	777
07	108	240	252	348	372	468	480	576	600	623	708	743	754	851
07	120	261	273	380	403	510	522	629	652	675	771	806	817	924
07	144	282	294	411	435	552	564	681	705	728	834	869	880	998
08	36	171	183	245	268	330	342	404	427	450	501	536	547	609
08	48	197	209	284	307	382	394	469	492	515	579	614	625	700
08	72	223	235	323	346	434	446	534	557	580	657	692	703	791
08	84	249	261	362	385	486	498	599	622	645	735	770	781	882
08	108	275	287	401	424	538	550	664	687	710	813	848	859	973
08	120	301	313	440	463	590	602	729	752	775	891	926	937	1,064
08	144	327	339	479	502	642	654	794	817	840	969	1,004	1,015	1,155
09	36	183	195	263	286	354	366	434	457	480	537	572	583	651
09	48	213	225	308	331	414	426	509	532	555	627	662	673	756
09	72	243	255	353	376	474	486	584	607	630	717	752	763	861
09	84	273	285	398	421	534	546	659	682	705	807	842	853	966
09	108	303	315	443	466	594	606	734	757	780	897	932	943	1,071
09	120	333	345	488	511	654	666	809	832	855	987	1,022	1,033	1,176
09	144	363	375	533	556	714	726	884	907	930	1,077	1,112	1,123	1,281
10	36	195	207	281	304	378	390	464	487	510	573	608	619	693
10	48	229	241	332	355	446	458	549	572	595	675	710	721	812
10	72	263	275	383	406	514	526	634	657	680	777	812	823	931
10	84	297	309	434	457	582	594	719	742	765	879	914	925	1,050
10	108	331	343	485	508	650	662	804	827	850	981	1,016	1,027	1,169
10	120	365	377	536	559	718	730	889	912	935	1,083	1,118	1,129	1,288
10	144	399	411	587	610	786	798	974	997	1,020	1,185	1,220	1,231	1,407
11	36	207	219	299	322	402	414	494	517	540	609	644	655	735
11	48	245	257	356	379	478	490	589	612	635	723	758	769	868
11	72	283	295	413	436	554	566	684	707	730	837	872	883	1,001
11	84	321	333	470	493	630	642	779	802	825	951	986	997	1,134
11	108	359	371	527	550	706	718	874	897	920	1,065	1,100	1,111	1,267
11	120	397	409	584	607	782	794	969	992	1,015	1,179	1,214	1,225	1,400
11	144	435	447	641	664	858	870	1,064	1,087	1,110	1,293	1,328	1,339	1,533
12	36	219	231	317	340	426	438	524	547	570	645	680	691	777
12	48	261	273	380	403	510	522	629	652	675	771	806	817	924
12	72	303	315	443	466	594	606	734	757	780	897	932	943	1,071
12	84	345	357	506	529	678	690	839	862	885	1,023	1,058	1,069	1,218
12	108	387	399	569	592	762	774	944	967	990	1,149	1,184	1,195	1,365
12	120	429	441	632	655	846	858	1,049	1,072	1,095	1,275	1,310	1,321	1,512
12	144	471	483	695	718	930	942	1,154	1,177	1,200	1,401	1,436	1,447	1,659
13	36	231	243	335	358	450	462	554	577	600	681	716	727	819
13	48	277	289	404	427	542	554	669	692	715	819	854	865	980
13	72	323	335	473	496	634	646	784	807	830	957	992	1,003	1,141
13	84	369	381	542	565	726	738	899	922	945	1,095	1,130	1,141	1,302
13	108	415	427	611	634	818	830	1,014	1,037	1,060	1,233	1,268	1,279	1,463
13	120	461	473	680	703	910	922	1,129	1,152	1,175	1,371	1,406	1,417	1,624
13	144	507	519	749	772	1,002	1,014	1,244	1,267	1,290	1,509	1,544	1,555	1,785
14	36	243	255	353	376	474	486	584	607	630	717	752	763	861
14	48	293	305	428	451	574	586	709	732	755	867	902	913	1,036
14	72	343	355	503	526	674	686	834	857	880	1,017	1,052	1,063	1,211
14	84	393	405	578	601	774	786	959	982	1,005	1,167	1,202	1,213	1,386
14	108	443	455	653	676	874	886	1,084	1,107	1,130	1,317	1,352	1,363	1,561
14	120	493	505	728	751	974	986	1,209	1,232	1,255	1,467	1,502	1,513	1,736
14	144	543	555	803	826	1,074	1,086	1,334	1,357	1,380	1,617	1,652	1,663	1,911
15	36	255	267	371	394	498	510	614	637	660	753	788	799	903
15	48	309	321	452	475	606	618	749	772	795	915	950	961	1,092
15	72	363	375	533	556	714	726	884	907	930	1,077	1,112	1,123	1,281
15	84	417	429	614	637	822	834	1,019	1,042	1,065	1,239	1,274	1,285	1,470
15	108	471	483	695	718	930	942	1,154	1,177	1,200	1,401	1,436	1,447	1,659
15	120	525	537	776	799	1,038	1,050	1,289	1,312	1,335	1,563	1,598	1,609	1,848
15	144	579	591	857	880	1,146	1,158	1,424	1,447	1,470	1,725	1,760	1,771	2,037
16	36	267	279	389	412	522	534	644	667	690	789	824	835	945
16	48	325	337	476	499	638	650	789	812	835	963	998	1,009	1,148
16	72	383	395	563	586	754	766	934	957	980	1,137	1,172	1,183	1,351
16	84	441	453	650	673	870	882	1,079	1,102	1,125	1,311	1,346	1,357	1,554
16	108	499	511	737	760	986	998	1,224	1,247	1,270	1,485	1,520	1,531	1,757
16	120	557	569	824	847	1,102	1,114	1,369	1,392	1,415	1,659	1,694	1,705	1,960
16	144	615	627	911	934	1,218	1,230	1,514	1,537	1,560	1,833	1,868	1,879	2,163

RIPPLEFOLD: 80% Fullness — Unlined

Pricing for butt or overlap master panels with 4" hem (additional charge for larger hems). Sizes and series numbers beyond what is listed below are available—please submit these quote requests via fax or email.

Series	Length	Finished Pair or Panel Width												
		36"	48"	60"	72"	84"	96"	108"	120"	132"	144"	156"	168"	180"
17	36	279	291	407	430	546	558	674	697	720	825	860	871	987
17	48	341	353	500	523	670	682	829	852	875	1,011	1,046	1,057	1,204
17	72	403	415	593	616	794	806	984	1,007	1,030	1,197	1,232	1,243	1,421
17	84	465	477	686	709	918	930	1,139	1,162	1,185	1,383	1,418	1,429	1,638
17	108	527	539	779	802	1,042	1,054	1,294	1,317	1,340	1,569	1,604	1,615	1,855
17	120	589	601	872	895	1,166	1,178	1,449	1,472	1,495	1,755	1,790	1,801	2,072
17	144	651	663	965	988	1,290	1,302	1,604	1,627	1,650	1,941	1,976	1,987	2,289
18	36	291	303	425	448	570	582	704	727	750	861	896	907	1,029
18	48	357	369	524	547	702	714	869	892	915	1,059	1,094	1,105	1,260
18	72	423	435	623	646	834	846	1,034	1,057	1,080	1,257	1,292	1,303	1,491
18	84	489	501	722	745	966	978	1,199	1,222	1,245	1,455	1,490	1,501	1,722
18	108	555	567	821	844	1,098	1,110	1,364	1,387	1,410	1,653	1,688	1,699	1,953
18	120	621	633	920	943	1,230	1,242	1,529	1,552	1,575	1,851	1,886	1,897	2,184
18	144	687	699	1,019	1,042	1,362	1,374	1,694	1,717	1,740	2,049	2,084	2,095	2,415
19	36	303	315	443	466	594	606	734	757	780	897	932	943	1,071
19	48	373	385	548	571	734	746	909	932	955	1,107	1,142	1,153	1,316
19	72	443	455	653	676	874	886	1,084	1,107	1,130	1,317	1,352	1,363	1,561
19	84	513	525	758	781	1,014	1,026	1,259	1,282	1,305	1,527	1,562	1,573	1,806
19	108	583	595	863	886	1,154	1,166	1,434	1,457	1,480	1,737	1,772	1,783	2,051
19	120	653	665	968	991	1,294	1,306	1,609	1,632	1,655	1,947	1,982	1,993	2,296
19	144	723	735	1,073	1,096	1,434	1,446	1,784	1,807	1,830	2,157	2,192	2,203	2,541
20	36	315	327	461	484	618	630	764	787	810	933	968	979	1,113
20	48	389	401	572	595	766	778	949	972	995	1,155	1,190	1,201	1,372
20	72	463	475	683	706	914	926	1,134	1,157	1,180	1,377	1,412	1,423	1,631
20	84	537	549	794	817	1,062	1,074	1,319	1,342	1,365	1,599	1,634	1,645	1,890
20	108	611	623	905	928	1,210	1,222	1,504	1,527	1,550	1,821	1,856	1,867	2,149
20	120	685	697	1,016	1,039	1,358	1,370	1,689	1,712	1,735	2,043	2,078	2,089	2,408
20	144	759	771	1,127	1,150	1,506	1,518	1,874	1,897	1,920	2,265	2,300	2,311	2,667
21	36	327	339	479	502	642	654	794	817	840	969	1,004	1,015	1,155
21	48	405	417	596	619	798	810	989	1,012	1,035	1,203	1,238	1,249	1,428
21	72	483	495	713	736	954	966	1,184	1,207	1,230	1,437	1,472	1,483	1,701
21	84	561	573	830	853	1,110	1,122	1,379	1,402	1,425	1,671	1,706	1,717	1,974
21	108	639	651	947	970	1,266	1,278	1,574	1,597	1,620	1,905	1,940	1,951	2,247
21	120	717	729	1,064	1,087	1,422	1,434	1,769	1,792	1,815	2,139	2,174	2,185	2,520
21	144	795	807	1,181	1,204	1,578	1,590	1,964	1,987	2,010	2,373	2,408	2,419	2,793
22	36	339	351	497	520	666	678	824	847	870	1,005	1,040	1,051	1,197
22	48	421	433	620	643	830	842	1,029	1,052	1,075	1,251	1,286	1,297	1,484
22	72	503	515	743	766	994	1,006	1,234	1,257	1,280	1,497	1,532	1,543	1,771
22	84	585	597	866	889	1,158	1,170	1,439	1,462	1,485	1,743	1,778	1,789	2,058
22	108	667	679	989	1,012	1,322	1,334	1,644	1,667	1,690	1,989	2,024	2,035	2,345
22	120	749	761	1,112	1,135	1,486	1,498	1,849	1,872	1,895	2,235	2,270	2,281	2,632
22	144	831	843	1,235	1,258	1,650	1,662	2,054	2,077	2,100	2,481	2,516	2,527	2,919
23	36	351	363	515	538	690	702	854	877	900	1,041	1,076	1,087	1,239
23	48	437	449	644	667	862	874	1,069	1,092	1,115	1,299	1,334	1,345	1,540
23	72	523	535	773	796	1,034	1,046	1,284	1,307	1,330	1,557	1,592	1,603	1,841
23	84	609	621	902	925	1,206	1,218	1,499	1,522	1,545	1,815	1,850	1,861	2,142
23	108	695	707	1,031	1,054	1,378	1,390	1,714	1,737	1,760	2,073	2,108	2,119	2,443
23	120	781	793	1,160	1,183	1,550	1,562	1,929	1,952	1,975	2,331	2,366	2,377	2,744
23	144	867	879	1,289	1,312	1,722	1,734	2,144	2,167	2,190	2,589	2,624	2,635	3,045
24	36	363	375	533	556	714	726	884	907	930	1,077	1,112	1,123	1,281
24	48	453	465	668	691	894	906	1,109	1,132	1,155	1,347	1,382	1,393	1,596
24	72	543	555	803	826	1,074	1,086	1,334	1,357	1,380	1,617	1,652	1,663	1,911
24	84	633	645	938	961	1,254	1,266	1,559	1,582	1,605	1,887	1,922	1,933	2,226
24	108	723	735	1,073	1,096	1,434	1,446	1,784	1,807	1,830	2,157	2,192	2,203	2,541
24	120	813	825	1,208	1,231	1,614	1,626	2,009	2,032	2,055	2,427	2,462	2,473	2,856
24	144	903	915	1,343	1,366	1,794	1,806	2,234	2,257	2,280	2,697	2,732	2,743	3,171
25	36	381	393	560	583	750	762	929	952	975	1,131	1,166	1,177	1,344
25	48	477	489	704	727	942	954	1,169	1,192	1,215	1,419	1,454	1,465	1,680
25	72	573	585	848	871	1,134	1,146	1,409	1,432	1,455	1,707	1,742	1,753	2,016
25	84	669	681	992	1,015	1,326	1,338	1,649	1,672	1,695	1,995	2,030	2,041	2,352
25	108	765	777	1,136	1,159	1,518	1,530	1,889	1,912	1,935	2,283	2,318	2,329	2,688
25	120	861	873	1,280	1,303	1,710	1,722	2,129	2,152	2,175	2,571	2,606	2,617	3,024
25	144	957	969	1,424	1,447	1,902	1,914	2,369	2,392	2,415	2,859	2,894	2,905	3,360
26	36	393	405	578	601	774	786	959	982	1,005	1,167	1,202	1,213	1,386
26	48	493	505	728	751	974	986	1,209	1,232	1,255	1,467	1,502	1,513	1,736
26	72	593	605	878	901	1,174	1,186	1,459	1,482	1,505	1,767	1,802	1,813	2,086
26	84	693	705	1,028	1,051	1,374	1,386	1,709	1,732	1,755	2,067	2,102	2,113	2,436
26	108	793	805	1,178	1,201	1,574	1,586	1,959	1,982	2,005	2,367	2,402	2,413	2,786
26	120	893	905	1,328	1,351	1,774	1,786	2,209	2,232	2,255	2,667	2,702	2,713	3,136
26	144	993	1,005	1,478	1,501	1,974	1,986	2,459	2,482	2,505	2,967	3,002	3,013	3,486

RIPPLEFOLD: 80% Fullness — Lined (Lining 01000)

Pricing for butt or overlap master panels with 4" hem (additional charge for larger hems). Sizes and series numbers beyond what is listed below are available—please submit these quote requests via fax or email.

Series	Length	Finished Pair or Panel Width												
		36"	48"	60"	72"	84"	96"	108"	120"	132"	144"	156"	168"	180"
07	36	263	277	365	423	482	525	584	642	699	744	815	829	918
07	48	284	298	397	454	524	567	637	694	751	807	878	892	991
07	60	284	298	397	454	524	567	637	694	751	807	878	892	991
07	72	305	319	428	486	566	609	689	747	804	870	941	955	1,065
07	84	326	340	460	517	608	651	742	799	856	933	1,004	1,018	1,138
07	96	326	340	460	517	608	651	742	799	856	933	1,004	1,018	1,138
07	101	347	361	491	549	650	693	794	852	909	996	1,067	1,081	1,212
08	36	278	292	388	445	512	555	622	679	736	789	860	874	970
08	48	304	318	427	484	564	607	687	744	801	867	938	952	1,061
08	60	304	318	427	484	564	607	687	744	801	867	938	952	1,061
08	72	330	344	466	523	616	659	752	809	866	945	1,016	1,030	1,152
08	84	356	370	505	562	668	711	817	874	931	1,023	1,094	1,108	1,243
08	96	356	370	505	562	668	711	817	874	931	1,023	1,094	1,108	1,243
08	101	382	396	544	601	720	763	882	939	996	1,101	1,172	1,186	1,334
09	36	290	304	406	463	536	579	652	709	766	825	896	910	1,012
09	48	320	334	451	508	596	639	727	784	841	915	986	1,000	1,117
09	60	320	334	451	508	596	639	727	784	841	915	986	1,000	1,117
09	72	350	364	496	553	656	699	802	859	916	1,005	1,076	1,090	1,222
09	84	380	394	541	598	716	759	877	934	991	1,095	1,166	1,180	1,327
09	96	380	394	541	598	716	759	877	934	991	1,095	1,166	1,180	1,327
09	101	410	424	586	643	776	819	952	1,009	1,066	1,185	1,256	1,270	1,432
10	36	302	316	424	481	560	603	682	739	796	861	932	946	1,054
10	48	336	350	475	532	628	671	767	824	881	963	1,034	1,048	1,173
10	60	336	350	475	532	628	671	767	824	881	963	1,034	1,048	1,173
10	72	370	384	526	583	696	739	852	909	966	1,065	1,136	1,150	1,292
10	84	404	418	577	634	764	807	937	994	1,051	1,167	1,238	1,252	1,411
10	96	404	418	577	634	764	807	937	994	1,051	1,167	1,238	1,252	1,411
10	101	438	452	628	685	832	875	1,022	1,079	1,136	1,269	1,340	1,354	1,530
11	36	314	328	442	499	584	627	712	769	826	897	968	982	1,096
11	48	352	366	499	556	660	703	807	864	921	1,011	1,082	1,096	1,229
11	60	352	366	499	556	660	703	807	864	921	1,011	1,082	1,096	1,229
11	72	390	404	556	613	736	779	902	959	1,016	1,125	1,196	1,210	1,362
11	84	428	442	613	670	812	855	997	1,054	1,111	1,239	1,310	1,324	1,495
11	96	428	442	613	670	812	855	997	1,054	1,111	1,239	1,310	1,324	1,495
11	101	466	480	670	727	888	931	1,092	1,149	1,206	1,353	1,424	1,438	1,628
12	36	326	340	460	517	608	651	742	799	856	933	1,004	1,018	1,138
12	48	368	382	523	580	692	735	847	904	961	1,059	1,130	1,144	1,285
12	60	368	382	523	580	692	735	847	904	961	1,059	1,130	1,144	1,285
12	72	410	424	586	643	776	819	952	1,009	1,066	1,185	1,256	1,270	1,432
12	84	452	466	649	706	860	903	1,057	1,114	1,171	1,311	1,382	1,396	1,579
12	96	452	466	649	706	860	903	1,057	1,114	1,171	1,311	1,382	1,396	1,579
12	101	494	508	712	769	944	987	1,162	1,219	1,276	1,437	1,508	1,522	1,726
13	36	338	352	478	535	632	675	772	829	886	969	1,040	1,054	1,180
13	48	384	398	547	604	724	767	887	944	1,001	1,107	1,178	1,192	1,341
13	60	384	398	547	604	724	767	887	944	1,001	1,107	1,178	1,192	1,341
13	72	430	444	616	673	816	859	1,002	1,059	1,116	1,245	1,316	1,330	1,502
13	84	476	490	685	742	908	951	1,117	1,174	1,231	1,383	1,454	1,468	1,663
13	96	476	490	685	742	908	951	1,117	1,174	1,231	1,383	1,454	1,468	1,663
13	101	522	536	754	811	1,000	1,043	1,232	1,289	1,346	1,521	1,592	1,606	1,824
14	36	350	364	496	553	656	699	802	859	916	1,005	1,076	1,090	1,222
14	48	400	414	571	628	756	799	927	984	1,041	1,155	1,226	1,240	1,397
14	60	400	414	571	628	756	799	927	984	1,041	1,155	1,226	1,240	1,397
14	72	450	464	646	703	856	899	1,052	1,109	1,166	1,305	1,376	1,390	1,572
14	84	500	514	721	778	956	999	1,177	1,234	1,291	1,455	1,526	1,540	1,747
14	96	500	514	721	778	956	999	1,177	1,234	1,291	1,455	1,526	1,540	1,747
14	101	550	564	796	853	1,056	1,099	1,302	1,359	1,416	1,605	1,676	1,690	1,922
15	36	362	376	514	571	680	723	832	889	946	1,041	1,112	1,126	1,264
15	48	416	430	595	652	788	831	967	1,024	1,081	1,203	1,274	1,288	1,453
15	60	416	430	595	652	788	831	967	1,024	1,081	1,203	1,274	1,288	1,453
15	72	470	484	676	733	896	939	1,102	1,159	1,216	1,365	1,436	1,450	1,642
15	84	524	538	757	814	1,004	1,047	1,237	1,294	1,351	1,527	1,598	1,612	1,831
15	96	524	538	757	814	1,004	1,047	1,237	1,294	1,351	1,527	1,598	1,612	1,831
15	101	578	592	838	895	1,112	1,155	1,372	1,429	1,486	1,689	1,760	1,774	2,020
16	36	374	388	532	589	704	747	862	919	976	1,077	1,148	1,162	1,306
16	48	432	446	619	676	820	863	1,007	1,064	1,121	1,251	1,322	1,336	1,509
16	60	432	446	619	676	820	863	1,007	1,064	1,121	1,251	1,322	1,336	1,509
16	72	490	504	706	763	936	979	1,152	1,209	1,266	1,425	1,496	1,510	1,712
16	84	548	562	793	850	1,052	1,095	1,297	1,354	1,411	1,599	1,670	1,684	1,915
16	96	548	562	793	850	1,052	1,095	1,297	1,354	1,411	1,599	1,670	1,684	1,915
16	101	606	620	880	937	1,168	1,211	1,442	1,499	1,556	1,773	1,844	1,858	2,118

RIPPLEFOLD: 80% Fullness — Lined (Lining 01000)

Pricing for butt or overlap master panels with 4" hem (additional charge for larger hems). Sizes and series numbers beyond what is listed below are available—please submit these quote requests via fax or email.

Series	Length	Finished Pair or Panel Width													
		36"	48"	60"	72"	84"	96"	108"	120"	132"	144"	156"	168"	180"	
17	36	386	400	550	607	728	771	892	949	1,006	1,113	1,184	1,198	1,348	
17	48	448	462	643	700	852	895	1,047	1,104	1,161	1,299	1,370	1,384	1,565	
17	60	448	462	643	700	852	895	1,047	1,104	1,161	1,299	1,370	1,384	1,565	
17	72	510	524	736	793	976	1,019	1,202	1,259	1,316	1,485	1,556	1,570	1,782	
17	84	572	586	829	886	1,100	1,143	1,357	1,414	1,471	1,671	1,742	1,756	1,999	
17	96	572	586	829	886	1,100	1,143	1,357	1,414	1,471	1,671	1,742	1,756	1,999	
17	101	634	648	922	979	1,224	1,267	1,512	1,569	1,626	1,857	1,928	1,942	2,216	
18	36	398	412	568	625	752	795	922	979	1,036	1,149	1,220	1,234	1,390	
18	48	464	478	667	724	884	927	1,087	1,144	1,201	1,347	1,418	1,432	1,621	
18	60	464	478	667	724	884	927	1,087	1,144	1,201	1,347	1,418	1,432	1,621	
18	72	530	544	766	823	1,016	1,059	1,252	1,309	1,366	1,545	1,616	1,630	1,852	
18	84	596	610	865	922	1,148	1,191	1,417	1,474	1,531	1,743	1,814	1,828	2,083	
18	96	596	610	865	922	1,148	1,191	1,417	1,474	1,531	1,743	1,814	1,828	2,083	
18	101	662	676	964	1,021	1,280	1,323	1,582	1,639	1,696	1,941	2,012	2,026	2,314	
19	36	410	424	586	643	776	819	952	1,009	1,066	1,185	1,256	1,270	1,432	
19	48	480	494	691	748	916	959	1,127	1,184	1,241	1,395	1,466	1,480	1,677	
19	60	480	494	691	748	916	959	1,127	1,184	1,241	1,395	1,466	1,480	1,677	
19	72	550	564	796	853	1,056	1,099	1,302	1,359	1,416	1,605	1,676	1,690	1,922	
19	84	620	634	901	958	1,196	1,239	1,477	1,534	1,591	1,815	1,886	1,900	2,167	
19	96	620	634	901	958	1,196	1,239	1,477	1,534	1,591	1,815	1,886	1,900	2,167	
19	101	690	704	1,006	1,063	1,336	1,379	1,652	1,709	1,766	2,025	2,096	2,110	2,412	
20	36	422	436	604	661	800	843	982	1,039	1,096	1,221	1,292	1,306	1,474	
20	48	496	510	715	772	948	991	1,167	1,224	1,281	1,443	1,514	1,528	1,733	
20	60	496	510	715	772	948	991	1,167	1,224	1,281	1,443	1,514	1,528	1,733	
20	72	570	584	826	883	1,096	1,139	1,352	1,409	1,466	1,665	1,736	1,750	1,992	
20	84	644	658	937	994	1,244	1,287	1,537	1,594	1,651	1,887	1,958	1,972	2,251	
20	96	644	658	937	994	1,244	1,287	1,537	1,594	1,651	1,887	1,958	1,972	2,251	
20	101	718	732	1,048	1,105	1,392	1,435	1,722	1,779	1,836	2,109	2,180	2,194	2,510	
21	36	434	448	622	679	824	867	1,012	1,069	1,126	1,257	1,328	1,342	1,516	
21	48	512	526	739	796	980	1,023	1,207	1,264	1,321	1,491	1,562	1,576	1,789	
21	60	512	526	739	796	980	1,023	1,207	1,264	1,321	1,491	1,562	1,576	1,789	
21	72	590	604	856	913	1,136	1,179	1,402	1,459	1,516	1,725	1,796	1,810	2,062	
21	84	668	682	973	1,030	1,292	1,335	1,597	1,654	1,711	1,959	2,030	2,044	2,335	
21	96	668	682	973	1,030	1,292	1,335	1,597	1,654	1,711	1,959	2,030	2,044	2,335	
21	101	746	760	1,090	1,147	1,448	1,491	1,792	1,849	1,906	2,193	2,264	2,278	2,608	
22	36	446	460	640	697	848	891	1,042	1,099	1,156	1,293	1,364	1,378	1,558	
22	48	528	542	763	820	1,012	1,055	1,247	1,304	1,361	1,539	1,610	1,624	1,845	
22	60	528	542	763	820	1,012	1,055	1,247	1,304	1,361	1,539	1,610	1,624	1,845	
22	72	610	624	886	943	1,176	1,219	1,452	1,509	1,566	1,785	1,856	1,870	2,132	
22	84	692	706	1,009	1,066	1,340	1,383	1,657	1,714	1,771	2,031	2,102	2,116	2,419	
22	96	692	706	1,009	1,066	1,340	1,383	1,657	1,714	1,771	2,031	2,102	2,116	2,419	
22	101	774	788	1,132	1,189	1,504	1,547	1,862	1,919	1,976	2,277	2,348	2,362	2,706	
23	36	458	472	658	715	872	915	1,072	1,129	1,186	1,329	1,400	1,414	1,600	
23	48	544	558	787	844	1,044	1,087	1,287	1,344	1,401	1,587	1,658	1,672	1,901	
23	60	544	558	787	844	1,044	1,087	1,287	1,344	1,401	1,587	1,658	1,672	1,901	
23	72	630	644	916	973	1,216	1,259	1,502	1,559	1,616	1,845	1,916	1,930	2,202	
23	84	716	730	1,045	1,102	1,388	1,431	1,717	1,774	1,831	2,103	2,174	2,188	2,503	
23	96	716	730	1,045	1,102	1,388	1,431	1,717	1,774	1,831	2,103	2,174	2,188	2,503	
23	101	802	816	1,174	1,231	1,560	1,603	1,932	1,989	2,046	2,361	2,432	2,446	2,804	
24	36	470	484	676	733	896	939	1,102	1,159	1,216	1,365	1,436	1,450	1,642	
24	48	560	574	811	868	1,076	1,119	1,327	1,384	1,441	1,635	1,706	1,720	1,957	
24	60	560	574	811	868	1,076	1,119	1,327	1,384	1,441	1,635	1,706	1,720	1,957	
24	72	650	664	946	1,003	1,256	1,299	1,552	1,609	1,666	1,905	1,976	1,990	2,272	
24	84	740	754	1,081	1,138	1,436	1,479	1,777	1,834	1,891	2,175	2,246	2,260	2,587	
24	96	740	754	1,081	1,138	1,436	1,479	1,777	1,834	1,891	2,175	2,246	2,260	2,587	
24	101	830	844	1,216	1,273	1,616	1,659	2,002	2,059	2,116	2,445	2,516	2,530	2,902	
25	36	488	502	703	760	932	975	1,147	1,204	1,261	1,419	1,490	1,504	1,705	
25	48	584	598	847	904	1,124	1,167	1,387	1,444	1,501	1,707	1,778	1,792	2,041	
25	60	584	598	847	904	1,124	1,167	1,387	1,444	1,501	1,707	1,778	1,792	2,041	
25	72	680	694	991	1,048	1,316	1,359	1,627	1,684	1,741	1,995	2,066	2,080	2,377	
25	84	776	790	1,135	1,192	1,508	1,551	1,867	1,924	1,981	2,283	2,354	2,368	2,713	
25	96	776	790	1,135	1,192	1,508	1,551	1,867	1,924	1,981	2,283	2,354	2,368	2,713	
25	101	872	886	1,279	1,336	1,700	1,743	2,107	2,164	2,221	2,571	2,642	2,656	3,049	
26	36	500	514	721	778	956	999	1,177	1,234	1,291	1,455	1,526	1,540	1,747	
26	48	600	614	871	928	1,156	1,199	1,427	1,484	1,541	1,755	1,826	1,840	2,097	
26	60	600	614	871	928	1,156	1,199	1,427	1,484	1,541	1,755	1,826	1,840	2,097	
26	72	700	714	1,021	1,078	1,356	1,399	1,677	1,734	1,791	2,055	2,126	2,140	2,447	
26	84	800	814	1,171	1,228	1,556	1,599	1,927	1,984	2,041	2,355	2,426	2,440	2,797	
26	96	800	814	1,171	1,228	1,556	1,599	1,927	1,984	2,041	2,355	2,426	2,440	2,797	
26	101	900	914	1,321	1,378	1,756	1,799	2,177	2,234	2,291	2,655	2,726	2,740	3,147	

RIPPLEFOLD: 100% Fullness — Unlined

Pricing for butt or overlap master panels with 4" hem (additional charge for larger hems). Sizes and series numbers beyond what is listed below are available—please submit these quote requests via fax or email.

Series	Length	Finished Pair or Panel Width												
		36"	48"	60"	72"	84"	96"	108"	120"	132"	144"	156"	168"	180"
07	36	156	211	234	289	312	366	390	413	467	491	545	580	623
07	48	177	242	265	331	354	419	442	465	530	554	619	653	707
07	72	198	274	297	373	396	471	495	518	593	617	692	727	791
07	84	219	305	328	415	438	524	547	570	656	680	766	800	875
07	108	240	337	360	457	480	576	600	623	719	743	839	874	959
07	120	261	368	391	499	522	629	652	675	782	806	913	947	1,043
07	144	282	400	423	541	564	681	705	728	845	869	986	1,021	1,127
08	36	171	233	256	319	342	404	427	450	512	536	598	632	683
08	48	197	272	295	371	394	469	492	515	590	614	689	723	787
08	72	223	311	334	423	446	534	557	580	668	692	780	814	891
08	84	249	350	373	475	498	599	622	645	746	770	871	905	995
08	108	275	389	412	527	550	664	687	710	824	848	962	996	1,099
08	120	301	428	451	579	602	729	752	775	902	926	1,053	1,087	1,203
08	144	327	467	490	631	654	794	817	840	980	1,004	1,144	1,178	1,307
09	36	183	251	274	343	366	434	457	480	548	572	640	674	731
09	48	213	296	319	403	426	509	532	555	638	662	745	779	851
09	72	243	341	364	463	486	584	607	630	728	752	850	884	971
09	84	273	386	409	523	546	659	682	705	818	842	955	989	1,091
09	108	303	431	454	583	606	734	757	780	908	932	1,060	1,094	1,211
09	120	333	476	499	643	666	809	832	855	998	1,022	1,165	1,199	1,331
09	144	363	521	544	703	726	884	907	930	1,088	1,112	1,270	1,304	1,451
10	36	195	269	292	367	390	464	487	510	584	608	682	716	779
10	48	229	320	343	435	458	549	572	595	686	710	801	835	915
10	72	263	371	394	503	526	634	657	680	788	812	920	954	1,051
10	84	297	422	445	571	594	719	742	765	890	914	1,039	1,073	1,187
10	108	331	473	496	639	662	804	827	850	992	1,016	1,158	1,192	1,323
10	120	365	524	547	707	730	889	912	935	1,094	1,118	1,277	1,311	1,459
10	144	399	575	598	775	798	974	997	1,020	1,196	1,220	1,396	1,430	1,595
11	36	207	287	310	391	414	494	517	540	620	644	724	758	827
11	48	245	344	367	467	490	589	612	635	734	758	857	891	979
11	72	283	401	424	543	566	684	707	730	848	872	990	1,024	1,131
11	84	321	458	481	619	642	779	802	825	962	986	1,123	1,157	1,283
11	108	359	515	538	695	718	874	897	920	1,076	1,100	1,256	1,290	1,435
11	120	397	572	595	771	794	969	992	1,015	1,190	1,214	1,389	1,423	1,587
11	144	435	629	652	847	870	1,064	1,087	1,110	1,304	1,328	1,522	1,556	1,739
12	36	219	305	328	415	438	524	547	570	656	680	766	800	875
12	48	261	368	391	499	522	629	652	675	782	806	913	947	1,043
12	72	303	431	454	583	606	734	757	780	908	932	1,060	1,094	1,211
12	84	345	494	517	667	690	839	862	885	1,034	1,058	1,207	1,241	1,379
12	108	387	557	580	751	774	944	967	990	1,160	1,184	1,354	1,388	1,547
12	120	429	620	643	835	858	1,049	1,072	1,095	1,286	1,310	1,501	1,535	1,715
12	144	471	683	706	919	942	1,154	1,177	1,200	1,412	1,436	1,648	1,682	1,883
13	36	231	323	346	439	462	554	577	600	692	716	808	842	923
13	48	277	392	415	531	554	669	692	715	830	854	969	1,003	1,107
13	72	323	461	484	623	646	784	807	830	968	992	1,130	1,164	1,291
13	84	369	530	553	715	738	899	922	945	1,106	1,130	1,291	1,325	1,475
13	108	415	599	622	807	830	1,014	1,037	1,060	1,244	1,268	1,452	1,486	1,659
13	120	461	668	691	899	922	1,129	1,152	1,175	1,382	1,406	1,613	1,647	1,843
13	144	507	737	760	991	1,014	1,244	1,267	1,290	1,520	1,544	1,774	1,808	2,027
14	36	243	341	364	463	486	584	607	630	728	752	850	884	971
14	48	293	416	439	563	586	709	732	755	878	902	1,025	1,059	1,171
14	72	343	491	514	663	686	834	857	880	1,028	1,052	1,200	1,234	1,371
14	84	393	566	589	763	786	959	982	1,005	1,178	1,202	1,375	1,409	1,571
14	108	443	641	664	863	886	1,084	1,107	1,130	1,328	1,352	1,550	1,584	1,771
14	120	493	716	739	963	986	1,209	1,232	1,255	1,478	1,502	1,725	1,759	1,971
14	144	543	791	814	1,063	1,086	1,334	1,357	1,380	1,628	1,652	1,900	1,934	2,171
15	36	255	359	382	487	510	614	637	660	764	788	892	926	1,019
15	48	309	440	463	595	618	749	772	795	926	950	1,081	1,115	1,235
15	72	363	521	544	703	726	884	907	930	1,088	1,112	1,270	1,304	1,451
15	84	417	602	625	811	834	1,019	1,042	1,065	1,250	1,274	1,459	1,493	1,667
15	108	471	683	706	919	942	1,154	1,177	1,200	1,412	1,436	1,648	1,682	1,883
15	120	525	764	787	1,027	1,050	1,289	1,312	1,335	1,574	1,598	1,837	1,871	2,099
15	144	579	845	868	1,135	1,158	1,424	1,447	1,470	1,736	1,760	2,026	2,060	2,315
16	36	267	377	400	511	534	644	667	690	800	824	934	968	1,067
16	48	325	464	487	627	650	789	812	835	974	998	1,137	1,171	1,299
16	72	383	551	574	743	766	934	957	980	1,148	1,172	1,340	1,374	1,531
16	84	441	638	661	859	882	1,079	1,102	1,125	1,322	1,346	1,543	1,577	1,763
16	108	499	725	748	975	998	1,224	1,247	1,270	1,496	1,520	1,746	1,780	1,995
16	120	557	812	835	1,091	1,114	1,369	1,392	1,415	1,670	1,694	1,949	1,983	2,227
16	144	615	899	922	1,207	1,230	1,514	1,537	1,560	1,844	1,868	2,152	2,186	2,459

RIPPLEFOLD: 100% Fullness — Unlined

Pricing for butt or overlap master panels with 4" hem (additional charge for larger hems). Sizes and series numbers beyond what is listed below are available—please submit these quote requests via fax or email.

Series	Length	Finished Pair or Panel Width												
		36"	48"	60"	72"	84"	96"	108"	120"	132"	144"	156"	168"	180"
17	36	279	395	418	535	558	674	697	720	836	860	976	1,010	1,115
17	48	341	488	511	659	682	829	852	875	1,022	1,046	1,193	1,227	1,363
17	72	403	581	604	783	806	984	1,007	1,030	1,208	1,232	1,410	1,444	1,611
17	84	465	674	697	907	930	1,139	1,162	1,185	1,394	1,418	1,627	1,661	1,859
17	108	527	767	790	1,031	1,054	1,294	1,317	1,340	1,580	1,604	1,844	1,878	2,107
17	120	589	860	883	1,155	1,178	1,449	1,472	1,495	1,766	1,790	2,061	2,095	2,355
17	144	651	953	976	1,279	1,302	1,604	1,627	1,650	1,952	1,976	2,278	2,312	2,603
18	36	291	413	436	559	582	704	727	750	872	896	1,018	1,052	1,163
18	48	357	512	535	691	714	869	892	915	1,070	1,094	1,249	1,283	1,427
18	72	423	611	634	823	846	1,034	1,057	1,080	1,268	1,292	1,480	1,514	1,691
18	84	489	710	733	955	978	1,199	1,222	1,245	1,466	1,490	1,711	1,745	1,955
18	108	555	809	832	1,087	1,110	1,364	1,387	1,410	1,664	1,688	1,942	1,976	2,219
18	120	621	908	931	1,219	1,242	1,529	1,552	1,575	1,862	1,886	2,173	2,207	2,483
18	144	687	1,007	1,030	1,351	1,374	1,694	1,717	1,740	2,060	2,084	2,404	2,438	2,747
19	36	303	431	454	583	606	734	757	780	908	932	1,060	1,094	1,211
19	48	373	536	559	723	746	909	932	955	1,118	1,142	1,305	1,339	1,491
19	72	443	641	664	863	886	1,084	1,107	1,130	1,328	1,352	1,550	1,584	1,771
19	84	513	746	769	1,003	1,026	1,259	1,282	1,305	1,538	1,562	1,795	1,829	2,051
19	108	583	851	874	1,143	1,166	1,434	1,457	1,480	1,748	1,772	2,040	2,074	2,331
19	120	653	956	979	1,283	1,306	1,609	1,632	1,655	1,958	1,982	2,285	2,319	2,611
19	144	723	1,061	1,084	1,423	1,446	1,784	1,807	1,830	2,168	2,192	2,530	2,564	2,891
20	36	315	449	472	607	630	764	787	810	944	968	1,102	1,136	1,259
20	48	389	560	583	755	778	949	972	995	1,166	1,190	1,361	1,395	1,555
20	72	463	671	694	903	926	1,134	1,157	1,180	1,388	1,412	1,620	1,654	1,851
20	84	537	782	805	1,051	1,074	1,319	1,342	1,365	1,610	1,634	1,879	1,913	2,147
20	108	611	893	916	1,199	1,222	1,504	1,527	1,550	1,832	1,856	2,138	2,172	2,443
20	120	685	1,004	1,027	1,347	1,370	1,689	1,712	1,735	2,054	2,078	2,397	2,431	2,739
20	144	759	1,115	1,138	1,495	1,518	1,874	1,897	1,920	2,276	2,300	2,656	2,690	3,035
21	36	327	467	490	631	654	794	817	840	980	1,004	1,144	1,178	1,307
21	48	405	584	607	787	810	989	1,012	1,035	1,214	1,238	1,417	1,451	1,619
21	72	483	701	724	943	966	1,184	1,207	1,230	1,448	1,472	1,690	1,724	1,931
21	84	561	818	841	1,099	1,122	1,379	1,402	1,425	1,682	1,706	1,963	1,997	2,243
21	108	639	935	958	1,255	1,278	1,574	1,597	1,620	1,916	1,940	2,236	2,270	2,555
21	120	717	1,052	1,075	1,411	1,434	1,769	1,792	1,815	2,150	2,174	2,509	2,543	2,867
21	144	795	1,169	1,192	1,567	1,590	1,964	1,987	2,010	2,384	2,408	2,782	2,816	3,179
22	36	339	485	508	655	678	824	847	870	1,016	1,040	1,186	1,220	1,355
22	48	421	608	631	819	842	1,029	1,052	1,075	1,262	1,286	1,473	1,507	1,683
22	72	503	731	754	983	1,006	1,234	1,257	1,280	1,508	1,532	1,760	1,794	2,011
22	84	585	854	877	1,147	1,170	1,439	1,462	1,485	1,754	1,778	2,047	2,081	2,339
22	108	667	977	1,000	1,311	1,334	1,644	1,667	1,690	2,000	2,024	2,334	2,368	2,667
22	120	749	1,100	1,123	1,475	1,498	1,849	1,872	1,895	2,246	2,270	2,621	2,655	2,995
22	144	831	1,223	1,246	1,639	1,662	2,054	2,077	2,100	2,492	2,516	2,908	2,942	3,323
23	36	351	503	526	679	702	854	877	900	1,052	1,076	1,228	1,262	1,403
23	48	437	632	655	851	874	1,069	1,092	1,115	1,310	1,334	1,529	1,563	1,747
23	72	523	761	784	1,023	1,046	1,284	1,307	1,330	1,568	1,592	1,830	1,864	2,091
23	84	609	890	913	1,195	1,218	1,499	1,522	1,545	1,826	1,850	2,131	2,165	2,435
23	108	695	1,019	1,042	1,367	1,390	1,714	1,737	1,760	2,084	2,108	2,432	2,466	2,779
23	120	781	1,148	1,171	1,539	1,562	1,929	1,952	1,975	2,342	2,366	2,733	2,767	3,123
23	144	867	1,277	1,300	1,711	1,734	2,144	2,167	2,190	2,600	2,624	3,034	3,068	3,467
24	36	363	521	544	703	726	884	907	930	1,088	1,112	1,270	1,304	1,451
24	48	453	656	679	883	906	1,109	1,132	1,155	1,358	1,382	1,585	1,619	1,811
24	72	543	791	814	1,063	1,086	1,334	1,357	1,380	1,628	1,652	1,900	1,934	2,171
24	84	633	926	949	1,243	1,266	1,559	1,582	1,605	1,898	1,922	2,215	2,249	2,531
24	108	723	1,061	1,084	1,423	1,446	1,784	1,807	1,830	2,168	2,192	2,530	2,564	2,891
24	120	813	1,196	1,219	1,603	1,626	2,009	2,032	2,055	2,438	2,462	2,845	2,879	3,251
24	144	903	1,331	1,354	1,783	1,806	2,234	2,257	2,280	2,708	2,732	3,160	3,194	3,611
25	36	381	548	571	739	762	929	952	975	1,142	1,166	1,333	1,367	1,523
25	48	477	692	715	931	954	1,169	1,192	1,215	1,430	1,454	1,669	1,703	1,907
25	72	573	836	859	1,123	1,146	1,409	1,432	1,455	1,718	1,742	2,005	2,039	2,291
25	84	669	980	1,003	1,315	1,338	1,649	1,672	1,695	2,006	2,030	2,341	2,375	2,675
25	108	765	1,124	1,147	1,507	1,530	1,889	1,912	1,935	2,294	2,318	2,677	2,711	3,059
25	120	861	1,268	1,291	1,699	1,722	2,129	2,152	2,175	2,582	2,606	3,013	3,047	3,443
25	144	957	1,412	1,435	1,891	1,914	2,369	2,392	2,415	2,870	2,894	3,349	3,383	3,827
26	36	393	566	589	763	786	959	982	1,005	1,178	1,202	1,375	1,409	1,571
26	48	493	716	739	963	986	1,209	1,232	1,255	1,478	1,502	1,725	1,759	1,971
26	72	593	866	889	1,163	1,186	1,459	1,482	1,505	1,778	1,802	2,075	2,109	2,371
26	84	693	1,016	1,039	1,363	1,386	1,709	1,732	1,755	2,078	2,102	2,425	2,459	2,771
26	108	793	1,166	1,189	1,563	1,586	1,959	1,982	2,005	2,378	2,402	2,775	2,809	3,171
26	120	893	1,316	1,339	1,763	1,786	2,209	2,232	2,255	2,678	2,702	3,125	3,159	3,571
26	144	993	1,466	1,489	1,963	1,986	2,459	2,482	2,505	2,978	3,002	3,475	3,509	3,971

RIPPLEFOLD: 100% Fullness — Lined (Lining O1000)

Pricing for butt or overlap master panels with 4" hem (additional charge for larger hems). Sizes and series numbers beyond what is listed below are available—please submit these quote requests via fax or email.

Series	Length	Finished Pair or Panel Width												
		36"	48"	60"	72"	84"	96"	108"	120"	132"	144"	156"	168"	180"
07	36	263	352	379	468	525	584	642	699	758	815	904	975	1,020
07	48	284	383	411	510	567	637	694	751	821	878	978	1,049	1,104
07	60	284	383	411	510	567	637	694	751	821	878	978	1,049	1,104
07	72	305	415	442	552	609	689	747	804	884	941	1,051	1,122	1,188
07	84	326	446	474	594	651	742	799	856	947	1,004	1,125	1,196	1,272
07	96	326	446	474	594	651	742	799	856	947	1,004	1,125	1,196	1,272
07	101	347	478	505	636	693	794	852	909	1,010	1,067	1,198	1,269	1,356
08	36	278	374	402	498	555	622	679	736	803	860	957	1,028	1,080
08	48	304	413	441	550	607	687	744	801	881	938	1,048	1,119	1,184
08	60	304	413	441	550	607	687	744	801	881	938	1,048	1,119	1,184
08	72	330	452	480	602	659	752	809	866	959	1,016	1,139	1,210	1,288
08	84	356	491	519	654	711	817	874	931	1,037	1,094	1,230	1,301	1,392
08	96	356	491	519	654	711	817	874	931	1,037	1,094	1,230	1,301	1,392
08	101	382	530	558	706	763	882	939	996	1,115	1,172	1,321	1,392	1,496
09	36	290	392	420	522	579	652	709	766	839	896	999	1,070	1,128
09	48	320	437	465	582	639	727	784	841	929	986	1,104	1,175	1,248
09	60	320	437	465	582	639	727	784	841	929	986	1,104	1,175	1,248
09	72	350	482	510	642	699	802	859	916	1,019	1,076	1,209	1,280	1,368
09	84	380	527	555	702	759	877	934	991	1,109	1,166	1,314	1,385	1,488
09	96	380	527	555	702	759	877	934	991	1,109	1,166	1,314	1,385	1,488
09	101	410	572	600	762	819	952	1,009	1,066	1,199	1,256	1,419	1,490	1,608
10	36	302	410	438	546	603	682	739	796	875	932	1,041	1,112	1,176
10	48	336	461	489	614	671	767	824	881	977	1,034	1,160	1,231	1,312
10	60	336	461	489	614	671	767	824	881	977	1,034	1,160	1,231	1,312
10	72	370	512	540	682	739	852	909	966	1,079	1,136	1,279	1,350	1,448
10	84	404	563	591	750	807	937	994	1,051	1,181	1,238	1,398	1,469	1,584
10	96	404	563	591	750	807	937	994	1,051	1,181	1,238	1,398	1,469	1,584
10	101	438	614	642	818	875	1,022	1,079	1,136	1,283	1,340	1,517	1,588	1,720
11	36	314	428	456	570	627	712	769	826	911	968	1,083	1,154	1,224
11	48	352	485	513	646	703	807	864	921	1,025	1,082	1,216	1,287	1,376
11	60	352	485	513	646	703	807	864	921	1,025	1,082	1,216	1,287	1,376
11	72	390	542	570	722	779	902	959	1,016	1,139	1,196	1,349	1,420	1,528
11	84	428	599	627	798	855	997	1,054	1,111	1,253	1,310	1,482	1,553	1,680
11	96	428	599	627	798	855	997	1,054	1,111	1,253	1,310	1,482	1,553	1,680
11	101	466	656	684	874	931	1,092	1,149	1,206	1,367	1,424	1,615	1,686	1,832
12	36	326	446	474	594	651	742	799	856	947	1,004	1,125	1,196	1,272
12	48	368	509	537	678	735	847	904	961	1,073	1,130	1,272	1,343	1,440
12	60	368	509	537	678	735	847	904	961	1,073	1,130	1,272	1,343	1,440
12	72	410	572	600	762	819	952	1,009	1,066	1,199	1,256	1,419	1,490	1,608
12	84	452	635	663	846	903	1,057	1,114	1,171	1,325	1,382	1,566	1,637	1,776
12	96	452	635	663	846	903	1,057	1,114	1,171	1,325	1,382	1,566	1,637	1,776
12	101	494	698	726	930	987	1,162	1,219	1,276	1,451	1,508	1,713	1,784	1,944
13	36	338	464	492	618	675	772	829	886	983	1,040	1,167	1,238	1,320
13	48	384	533	561	710	767	887	944	1,001	1,121	1,178	1,328	1,399	1,504
13	60	384	533	561	710	767	887	944	1,001	1,121	1,178	1,328	1,399	1,504
13	72	430	602	630	802	859	1,002	1,059	1,116	1,259	1,316	1,489	1,560	1,688
13	84	476	671	699	894	951	1,117	1,174	1,231	1,397	1,454	1,650	1,721	1,872
13	96	476	671	699	894	951	1,117	1,174	1,231	1,397	1,454	1,650	1,721	1,872
13	101	522	740	768	986	1,043	1,232	1,289	1,346	1,535	1,592	1,811	1,882	2,056
14	36	350	482	510	642	699	802	859	916	1,019	1,076	1,209	1,280	1,368
14	48	400	557	585	742	799	927	984	1,041	1,169	1,226	1,384	1,455	1,568
14	60	400	557	585	742	799	927	984	1,041	1,169	1,226	1,384	1,455	1,568
14	72	450	632	660	842	899	1,052	1,109	1,166	1,319	1,376	1,559	1,630	1,768
14	84	500	707	735	942	999	1,177	1,234	1,291	1,469	1,526	1,734	1,805	1,968
14	96	500	707	735	942	999	1,177	1,234	1,291	1,469	1,526	1,734	1,805	1,968
14	101	550	782	810	1,042	1,099	1,302	1,359	1,416	1,619	1,676	1,909	1,980	2,168
15	36	362	500	528	666	723	832	889	946	1,055	1,112	1,251	1,322	1,416
15	48	416	581	609	774	831	967	1,024	1,081	1,217	1,274	1,440	1,511	1,632
15	60	416	581	609	774	831	967	1,024	1,081	1,217	1,274	1,440	1,511	1,632
15	72	470	662	690	882	939	1,102	1,159	1,216	1,379	1,436	1,629	1,700	1,848
15	84	524	743	771	990	1,047	1,237	1,294	1,351	1,541	1,598	1,818	1,889	2,064
15	96	524	743	771	990	1,047	1,237	1,294	1,351	1,541	1,598	1,818	1,889	2,064
15	101	578	824	852	1,098	1,155	1,372	1,429	1,486	1,703	1,760	2,007	2,078	2,280
16	36	374	518	546	690	747	862	919	976	1,091	1,148	1,293	1,364	1,464
16	48	432	605	633	806	863	1,007	1,064	1,121	1,265	1,322	1,496	1,567	1,696
16	60	432	605	633	806	863	1,007	1,064	1,121	1,265	1,322	1,496	1,567	1,696
16	72	490	692	720	922	979	1,152	1,209	1,266	1,439	1,496	1,699	1,770	1,928
16	84	548	779	807	1,038	1,095	1,297	1,354	1,411	1,613	1,670	1,902	1,973	2,160
16	96	548	779	807	1,038	1,095	1,297	1,354	1,411	1,613	1,670	1,902	1,973	2,160
16	101	606	866	894	1,154	1,211	1,442	1,499	1,556	1,787	1,844	2,105	2,176	2,392

RIPPLEFOLD: 100% Fullness — Lined (Lining O1000)

Pricing for butt or overlap master panels with 4" hem (additional charge for larger hems). Sizes and series numbers beyond what is listed below are available—please submit these quote requests via fax or email.

Series	Length	Finished Pair or Panel Width												
		36"	48"	60"	72"	84"	96"	108"	120"	132"	144"	156"	168"	180"
17	36	386	536	564	714	771	892	949	1,006	1,127	1,184	1,335	1,406	1,512
17	48	448	629	657	838	895	1,047	1,104	1,161	1,313	1,370	1,552	1,623	1,760
17	60	448	629	657	838	895	1,047	1,104	1,161	1,313	1,370	1,552	1,623	1,760
17	72	510	722	750	962	1,019	1,202	1,259	1,316	1,499	1,556	1,769	1,840	2,008
17	84	572	815	843	1,086	1,143	1,357	1,414	1,471	1,685	1,742	1,986	2,057	2,256
17	96	572	815	843	1,086	1,143	1,357	1,414	1,471	1,685	1,742	1,986	2,057	2,256
17	101	634	908	936	1,210	1,267	1,512	1,569	1,626	1,871	1,928	2,203	2,274	2,504
18	36	398	554	582	738	795	922	979	1,036	1,163	1,220	1,377	1,448	1,560
18	48	464	653	681	870	927	1,087	1,144	1,201	1,361	1,418	1,608	1,679	1,824
18	60	464	653	681	870	927	1,087	1,144	1,201	1,361	1,418	1,608	1,679	1,824
18	72	530	752	780	1,002	1,059	1,252	1,309	1,366	1,559	1,616	1,839	1,910	2,088
18	84	596	851	879	1,134	1,191	1,417	1,474	1,531	1,757	1,814	2,070	2,141	2,352
18	96	596	851	879	1,134	1,191	1,417	1,474	1,531	1,757	1,814	2,070	2,141	2,352
18	101	662	950	978	1,266	1,323	1,582	1,639	1,696	1,955	2,012	2,301	2,372	2,616
19	36	410	572	600	762	819	952	1,009	1,066	1,199	1,256	1,419	1,490	1,608
19	48	480	677	705	902	959	1,127	1,184	1,241	1,409	1,466	1,664	1,735	1,888
19	60	480	677	705	902	959	1,127	1,184	1,241	1,409	1,466	1,664	1,735	1,888
19	72	550	782	810	1,042	1,099	1,302	1,359	1,416	1,619	1,676	1,909	1,980	2,168
19	84	620	887	915	1,182	1,239	1,477	1,534	1,591	1,829	1,886	2,154	2,225	2,448
19	96	620	887	915	1,182	1,239	1,477	1,534	1,591	1,829	1,886	2,154	2,225	2,448
19	101	690	992	1,020	1,322	1,379	1,652	1,709	1,766	2,039	2,096	2,399	2,470	2,728
20	36	422	590	618	786	843	982	1,039	1,096	1,235	1,292	1,461	1,532	1,656
20	48	496	701	729	934	991	1,167	1,224	1,281	1,457	1,514	1,720	1,791	1,952
20	60	496	701	729	934	991	1,167	1,224	1,281	1,457	1,514	1,720	1,791	1,952
20	72	570	812	840	1,082	1,139	1,352	1,409	1,466	1,679	1,736	1,979	2,050	2,248
20	84	644	923	951	1,230	1,287	1,537	1,594	1,651	1,901	1,958	2,238	2,309	2,544
20	96	644	923	951	1,230	1,287	1,537	1,594	1,651	1,901	1,958	2,238	2,309	2,544
20	101	718	1,034	1,062	1,378	1,435	1,722	1,779	1,836	2,123	2,180	2,497	2,568	2,840
21	36	434	608	636	810	867	1,012	1,069	1,126	1,271	1,328	1,503	1,574	1,704
21	48	512	725	753	966	1,023	1,207	1,264	1,321	1,505	1,562	1,776	1,847	2,016
21	60	512	725	753	966	1,023	1,207	1,264	1,321	1,505	1,562	1,776	1,847	2,016
21	72	590	842	870	1,122	1,179	1,402	1,459	1,516	1,739	1,796	2,049	2,120	2,328
21	84	668	959	987	1,278	1,335	1,597	1,654	1,711	1,973	2,030	2,322	2,393	2,640
21	96	668	959	987	1,278	1,335	1,597	1,654	1,711	1,973	2,030	2,322	2,393	2,640
21	101	746	1,076	1,104	1,434	1,491	1,792	1,849	1,906	2,207	2,264	2,595	2,666	2,952
22	36	446	626	654	834	891	1,042	1,099	1,156	1,307	1,364	1,545	1,616	1,752
22	48	528	749	777	998	1,055	1,247	1,304	1,361	1,553	1,610	1,832	1,903	2,080
22	60	528	749	777	998	1,055	1,247	1,304	1,361	1,553	1,610	1,832	1,903	2,080
22	72	610	872	900	1,162	1,219	1,452	1,509	1,566	1,799	1,856	2,119	2,190	2,408
22	84	692	995	1,023	1,326	1,383	1,657	1,714	1,771	2,045	2,102	2,406	2,477	2,736
22	96	692	995	1,023	1,326	1,383	1,657	1,714	1,771	2,045	2,102	2,406	2,477	2,736
22	101	774	1,118	1,146	1,490	1,547	1,862	1,919	1,976	2,291	2,348	2,693	2,764	3,064
23	36	458	644	672	858	915	1,072	1,129	1,186	1,343	1,400	1,587	1,658	1,800
23	48	544	773	801	1,030	1,087	1,287	1,344	1,401	1,601	1,658	1,888	1,959	2,144
23	60	544	773	801	1,030	1,087	1,287	1,344	1,401	1,601	1,658	1,888	1,959	2,144
23	72	630	902	930	1,202	1,259	1,502	1,559	1,616	1,859	1,916	2,189	2,260	2,488
23	84	716	1,031	1,059	1,374	1,431	1,717	1,774	1,831	2,117	2,174	2,490	2,561	2,832
23	96	716	1,031	1,059	1,374	1,431	1,717	1,774	1,831	2,117	2,174	2,490	2,561	2,832
23	101	802	1,160	1,188	1,546	1,603	1,932	1,989	2,046	2,375	2,432	2,791	2,862	3,176
24	36	470	662	690	882	939	1,102	1,159	1,216	1,379	1,436	1,629	1,700	1,848
24	48	560	797	825	1,062	1,119	1,327	1,384	1,441	1,649	1,706	1,944	2,015	2,208
24	60	560	797	825	1,062	1,119	1,327	1,384	1,441	1,649	1,706	1,944	2,015	2,208
24	72	650	932	960	1,242	1,299	1,552	1,609	1,666	1,919	1,976	2,259	2,330	2,568
24	84	740	1,067	1,095	1,422	1,479	1,777	1,834	1,891	2,189	2,246	2,574	2,645	2,928
24	96	740	1,067	1,095	1,422	1,479	1,777	1,834	1,891	2,189	2,246	2,574	2,645	2,928
24	101	830	1,202	1,230	1,602	1,659	2,002	2,059	2,116	2,459	2,516	2,889	2,960	3,288
25	36	488	689	717	918	975	1,147	1,204	1,261	1,433	1,490	1,692	1,763	1,920
25	48	584	833	861	1,110	1,167	1,387	1,444	1,501	1,721	1,778	2,028	2,099	2,304
25	60	584	833	861	1,110	1,167	1,387	1,444	1,501	1,721	1,778	2,028	2,099	2,304
25	72	680	977	1,005	1,302	1,359	1,627	1,684	1,741	2,009	2,066	2,364	2,435	2,688
25	84	776	1,121	1,149	1,494	1,551	1,867	1,924	1,981	2,297	2,354	2,700	2,771	3,072
25	96	776	1,121	1,149	1,494	1,551	1,867	1,924	1,981	2,297	2,354	2,700	2,771	3,072
25	101	872	1,265	1,293	1,686	1,743	2,107	2,164	2,221	2,585	2,642	3,036	3,107	3,456
26	36	500	707	735	942	999	1,177	1,234	1,291	1,469	1,526	1,734	1,805	1,968
26	48	600	857	885	1,142	1,199	1,427	1,484	1,541	1,769	1,826	2,084	2,155	2,368
26	60	600	857	885	1,142	1,199	1,427	1,484	1,541	1,769	1,826	2,084	2,155	2,368
26	72	700	1,007	1,035	1,342	1,399	1,677	1,734	1,791	2,069	2,126	2,434	2,505	2,768
26	84	800	1,157	1,185	1,542	1,599	1,927	1,984	2,041	2,369	2,426	2,784	2,855	3,168
26	96	800	1,157	1,185	1,542	1,599	1,927	1,984	2,041	2,369	2,426	2,784	2,855	3,168
26	101	900	1,307	1,335	1,742	1,799	2,177	2,234	2,291	2,669	2,726	3,134	3,205	3,568

RIPPLEFOLD: 120% Fullness — Unlined

Pricing for butt or overlap master panels with 4" hem (additional charge for larger hems). Sizes and series numbers beyond what is listed below are available—please submit these quote requests via fax or email.

Series	Length	Finished Pair or Panel Width												
		36"	48"	60"	72"	84"	96"	108"	120"	132"	144"	156"	168"	180"
07	36	168	222	257	312	335	401	456	479	502	557	623	646	701
07	48	189	254	289	354	377	454	519	542	565	630	707	730	795
07	72	210	285	320	396	419	506	582	605	628	704	791	814	890
07	84	231	317	352	438	461	559	645	668	691	777	875	898	984
07	108	252	348	383	480	503	611	708	731	754	851	959	982	1,079
07	120	273	380	415	522	545	664	771	794	817	924	1,043	1,066	1,173
07	144	294	411	446	564	587	716	834	857	880	998	1,127	1,150	1,268
08	36	183	245	280	342	365	439	501	524	547	609	683	706	768
08	48	209	284	319	394	417	504	579	602	625	700	787	810	885
08	72	235	323	358	446	469	569	657	680	703	791	891	914	1,002
08	84	261	362	397	498	521	634	735	758	781	882	995	1,018	1,119
08	108	287	401	436	550	573	699	813	836	859	973	1,099	1,122	1,236
08	120	313	440	475	602	625	764	891	914	937	1,064	1,203	1,226	1,353
08	144	339	479	514	654	677	829	969	992	1,015	1,155	1,307	1,330	1,470
09	36	195	263	298	366	389	469	537	560	583	651	731	754	822
09	48	225	308	343	426	449	544	627	650	673	756	851	874	957
09	72	255	353	388	486	509	619	717	740	763	861	971	994	1,092
09	84	285	398	433	546	569	694	807	830	853	966	1,091	1,114	1,227
09	108	315	443	478	606	629	769	897	920	943	1,071	1,211	1,234	1,362
09	120	345	488	523	666	689	844	987	1,010	1,033	1,176	1,331	1,354	1,497
09	144	375	533	568	726	749	919	1,077	1,100	1,123	1,281	1,451	1,474	1,632
10	36	207	281	316	390	413	499	573	596	619	693	779	802	876
10	48	241	332	367	458	481	584	675	698	721	812	915	938	1,029
10	72	275	383	418	526	549	669	777	800	823	931	1,051	1,074	1,182
10	84	309	434	469	594	617	754	879	902	925	1,050	1,187	1,210	1,335
10	108	343	485	520	662	685	839	981	1,004	1,027	1,169	1,323	1,346	1,488
10	120	377	536	571	730	753	924	1,083	1,106	1,129	1,288	1,459	1,482	1,641
10	144	411	587	622	798	821	1,009	1,185	1,208	1,231	1,407	1,595	1,618	1,794
11	36	219	299	334	414	437	529	609	632	655	735	827	850	930
11	48	257	356	391	490	513	624	723	746	769	868	979	1,002	1,101
11	72	295	413	448	566	589	719	837	860	883	1,001	1,131	1,154	1,272
11	84	333	470	505	642	665	814	951	974	997	1,134	1,283	1,306	1,443
11	108	371	527	562	718	741	909	1,065	1,088	1,111	1,267	1,435	1,458	1,614
11	120	409	584	619	794	817	1,004	1,179	1,202	1,225	1,400	1,587	1,610	1,785
11	144	447	641	676	870	893	1,099	1,293	1,316	1,339	1,533	1,739	1,762	1,956
12	36	231	317	352	438	461	559	645	668	691	777	875	898	984
12	48	273	380	415	522	545	664	771	794	817	924	1,043	1,066	1,173
12	72	315	443	478	606	629	769	897	920	943	1,071	1,211	1,234	1,362
12	84	357	506	541	690	713	874	1,023	1,046	1,069	1,218	1,379	1,402	1,551
12	108	399	569	604	774	797	979	1,149	1,172	1,195	1,365	1,547	1,570	1,740
12	120	441	632	667	858	881	1,084	1,275	1,298	1,321	1,512	1,715	1,738	1,929
12	144	483	695	730	942	965	1,189	1,401	1,424	1,447	1,659	1,883	1,906	2,118
13	36	243	335	370	462	485	589	681	704	727	819	923	946	1,038
13	48	289	404	439	554	577	704	819	842	865	980	1,107	1,130	1,245
13	72	335	473	508	646	669	819	957	980	1,003	1,141	1,291	1,314	1,452
13	84	381	542	577	738	761	934	1,095	1,118	1,141	1,302	1,475	1,498	1,659
13	108	427	611	646	830	853	1,049	1,233	1,256	1,279	1,463	1,659	1,682	1,866
13	120	473	680	715	922	945	1,164	1,371	1,394	1,417	1,624	1,843	1,866	2,073
13	144	519	749	784	1,014	1,037	1,279	1,509	1,532	1,555	1,785	2,027	2,050	2,280
14	36	255	353	388	486	509	619	717	740	763	861	971	994	1,092
14	48	305	428	463	586	609	744	867	890	913	1,036	1,171	1,194	1,317
14	72	355	503	538	686	709	869	1,017	1,040	1,063	1,211	1,371	1,394	1,542
14	84	405	578	613	786	809	994	1,167	1,190	1,213	1,386	1,571	1,594	1,767
14	108	455	653	688	886	909	1,119	1,317	1,340	1,363	1,561	1,771	1,794	1,992
14	120	505	728	763	986	1,009	1,244	1,467	1,490	1,513	1,736	1,971	1,994	2,217
14	144	555	803	838	1,086	1,109	1,369	1,617	1,640	1,663	1,911	2,171	2,194	2,442
15	36	267	371	406	510	533	649	753	776	799	903	1,019	1,042	1,146
15	48	321	452	487	618	641	784	915	938	961	1,092	1,235	1,258	1,389
15	72	375	533	568	726	749	919	1,077	1,100	1,123	1,281	1,451	1,474	1,632
15	84	429	614	649	834	857	1,054	1,239	1,262	1,285	1,470	1,667	1,690	1,875
15	108	483	695	730	942	965	1,189	1,401	1,424	1,447	1,659	1,883	1,906	2,118
15	120	537	776	811	1,050	1,073	1,324	1,563	1,586	1,609	1,848	2,099	2,122	2,361
15	144	591	857	892	1,158	1,181	1,459	1,725	1,748	1,771	2,037	2,315	2,338	2,604
16	36	279	389	424	534	557	679	789	812	835	945	1,067	1,090	1,200
16	48	337	476	511	650	673	824	963	986	1,009	1,148	1,299	1,322	1,461
16	72	395	563	598	766	789	969	1,137	1,160	1,183	1,351	1,531	1,554	1,722
16	84	453	650	685	882	905	1,114	1,311	1,334	1,357	1,554	1,763	1,786	1,983
16	108	511	737	772	998	1,021	1,259	1,485	1,508	1,531	1,757	1,995	2,018	2,244
16	120	569	824	859	1,114	1,137	1,404	1,659	1,682	1,705	1,960	2,227	2,250	2,505
16	144	627	911	946	1,230	1,253	1,549	1,833	1,856	1,879	2,163	2,459	2,482	2,766

RIPPLEFOLD: 120% Fullness — Unlined

Pricing for butt or overlap master panels with 4" hem (additional charge for larger hems). Sizes and series numbers beyond what is listed below are available—please submit these quote requests via fax or email.

Series	Length	Finished Pair or Panel Width												
		36"	48"	60"	72"	84"	96"	108"	120"	132"	144"	156"	168"	180"
17	36	291	407	442	558	581	709	825	848	871	987	1,115	1,138	1,254
17	48	353	500	535	682	705	864	1,011	1,034	1,057	1,204	1,363	1,386	1,533
17	72	415	593	628	806	829	1,019	1,197	1,220	1,243	1,421	1,611	1,634	1,812
17	84	477	686	721	930	953	1,174	1,383	1,406	1,429	1,638	1,859	1,882	2,091
17	108	539	779	814	1,054	1,077	1,329	1,569	1,592	1,615	1,855	2,107	2,130	2,370
17	120	601	872	907	1,178	1,201	1,484	1,755	1,778	1,801	2,072	2,355	2,378	2,649
17	144	663	965	1,000	1,302	1,325	1,639	1,941	1,964	1,987	2,289	2,603	2,626	2,928
18	36	303	425	460	582	605	739	861	884	907	1,029	1,163	1,186	1,308
18	48	369	524	559	714	737	904	1,059	1,082	1,105	1,260	1,427	1,450	1,605
18	72	435	623	658	846	869	1,069	1,257	1,280	1,303	1,491	1,691	1,714	1,902
18	84	501	722	757	978	1,001	1,234	1,455	1,478	1,501	1,722	1,955	1,978	2,199
18	108	567	821	856	1,110	1,133	1,399	1,653	1,676	1,699	1,953	2,219	2,242	2,496
18	120	633	920	955	1,242	1,265	1,564	1,851	1,874	1,897	2,184	2,483	2,506	2,793
18	144	699	1,019	1,054	1,374	1,397	1,729	2,049	2,072	2,095	2,415	2,747	2,770	3,090
19	36	315	443	478	606	629	769	897	920	943	1,071	1,211	1,234	1,362
19	48	385	548	583	746	769	944	1,107	1,130	1,153	1,316	1,491	1,514	1,677
19	72	455	653	688	886	909	1,119	1,317	1,340	1,363	1,561	1,771	1,794	1,992
19	84	525	758	793	1,026	1,049	1,294	1,527	1,550	1,573	1,806	2,051	2,074	2,307
19	108	595	863	898	1,166	1,189	1,469	1,737	1,760	1,783	2,051	2,331	2,354	2,622
19	120	665	968	1,003	1,306	1,329	1,644	1,947	1,970	1,993	2,296	2,611	2,634	2,937
19	144	735	1,073	1,108	1,446	1,469	1,819	2,157	2,180	2,203	2,541	2,891	2,914	3,252
20	36	327	461	496	630	653	799	933	956	979	1,113	1,259	1,282	1,416
20	48	401	572	607	778	801	984	1,155	1,178	1,201	1,372	1,555	1,578	1,749
20	72	475	683	718	926	949	1,169	1,377	1,400	1,423	1,631	1,851	1,874	2,082
20	84	549	794	829	1,074	1,097	1,354	1,599	1,622	1,645	1,890	2,147	2,170	2,415
20	108	623	905	940	1,222	1,245	1,539	1,821	1,844	1,867	2,149	2,443	2,466	2,748
20	120	697	1,016	1,051	1,370	1,393	1,724	2,043	2,066	2,089	2,408	2,739	2,762	3,081
20	144	771	1,127	1,162	1,518	1,541	1,909	2,265	2,288	2,311	2,667	3,035	3,058	3,414
21	36	339	479	514	654	677	829	969	992	1,015	1,155	1,307	1,330	1,470
21	48	417	596	631	810	833	1,024	1,203	1,226	1,249	1,428	1,619	1,642	1,821
21	72	495	713	748	966	989	1,219	1,437	1,460	1,483	1,701	1,931	1,954	2,172
21	84	573	830	865	1,122	1,145	1,414	1,671	1,694	1,717	1,974	2,243	2,266	2,523
21	108	651	947	982	1,278	1,301	1,609	1,905	1,928	1,951	2,247	2,555	2,578	2,874
21	120	729	1,064	1,099	1,434	1,457	1,804	2,139	2,162	2,185	2,520	2,867	2,890	3,225
21	144	807	1,181	1,216	1,590	1,613	1,999	2,373	2,396	2,419	2,793	3,179	3,202	3,576
22	36	351	497	532	678	701	859	1,005	1,028	1,051	1,197	1,355	1,378	1,524
22	48	433	620	655	842	865	1,064	1,251	1,274	1,297	1,484	1,683	1,706	1,893
22	72	515	743	778	1,006	1,029	1,269	1,497	1,520	1,543	1,771	2,011	2,034	2,262
22	84	597	866	901	1,170	1,193	1,474	1,743	1,766	1,789	2,058	2,339	2,362	2,631
22	108	679	989	1,024	1,334	1,357	1,679	1,989	2,012	2,035	2,345	2,667	2,690	3,000
22	120	761	1,112	1,147	1,498	1,521	1,884	2,235	2,258	2,281	2,632	2,995	3,018	3,369
22	144	843	1,235	1,270	1,662	1,685	2,089	2,481	2,504	2,527	2,919	3,323	3,346	3,738
23	36	363	515	550	702	725	889	1,041	1,064	1,087	1,239	1,403	1,426	1,578
23	48	449	644	679	874	897	1,104	1,299	1,322	1,345	1,540	1,747	1,770	1,965
23	72	535	773	808	1,046	1,069	1,319	1,557	1,580	1,603	1,841	2,091	2,114	2,352
23	84	621	902	937	1,218	1,241	1,534	1,815	1,838	1,861	2,142	2,435	2,458	2,739
23	108	707	1,031	1,066	1,390	1,413	1,749	2,073	2,096	2,119	2,443	2,779	2,802	3,126
23	120	793	1,160	1,195	1,562	1,585	1,964	2,331	2,354	2,377	2,744	3,123	3,146	3,513
23	144	879	1,289	1,324	1,734	1,757	2,179	2,589	2,612	2,635	3,045	3,467	3,490	3,900
24	36	375	533	568	726	749	919	1,077	1,100	1,123	1,281	1,451	1,474	1,632
24	48	465	668	703	906	929	1,144	1,347	1,370	1,393	1,596	1,811	1,834	2,037
24	72	555	803	838	1,086	1,109	1,369	1,617	1,640	1,663	1,911	2,171	2,194	2,442
24	84	645	938	973	1,266	1,289	1,594	1,887	1,910	1,933	2,226	2,531	2,554	2,847
24	108	735	1,073	1,108	1,446	1,469	1,819	2,157	2,180	2,203	2,541	2,891	2,914	3,252
24	120	825	1,208	1,243	1,626	1,649	2,044	2,427	2,450	2,473	2,856	3,251	3,274	3,657
24	144	915	1,343	1,378	1,806	1,829	2,269	2,697	2,720	2,743	3,171	3,611	3,634	4,062
25	36	393	560	595	762	785	964	1,131	1,154	1,177	1,344	1,523	1,546	1,713
25	48	489	704	739	954	977	1,204	1,419	1,442	1,465	1,680	1,907	1,930	2,145
25	72	585	848	883	1,146	1,169	1,444	1,707	1,730	1,753	2,016	2,291	2,314	2,577
25	84	681	992	1,027	1,338	1,361	1,684	1,995	2,018	2,041	2,352	2,675	2,698	3,009
25	108	777	1,136	1,171	1,530	1,553	1,924	2,283	2,306	2,329	2,688	3,059	3,082	3,441
25	120	873	1,280	1,315	1,722	1,745	2,164	2,571	2,594	2,617	3,024	3,443	3,466	3,873
25	144	969	1,424	1,459	1,914	1,937	2,404	2,859	2,882	2,905	3,360	3,827	3,850	4,305
26	36	405	578	613	786	809	994	1,167	1,190	1,213	1,386	1,571	1,594	1,767
26	48	505	728	763	986	1,009	1,244	1,467	1,490	1,513	1,736	1,971	1,994	2,217
26	72	605	878	913	1,186	1,209	1,494	1,767	1,790	1,813	2,086	2,371	2,394	2,667
26	84	705	1,028	1,063	1,386	1,409	1,744	2,067	2,090	2,113	2,436	2,771	2,794	3,117
26	108	805	1,178	1,213	1,586	1,609	1,994	2,367	2,390	2,413	2,786	3,171	3,194	3,567
26	120	905	1,328	1,363	1,786	1,809	2,244	2,667	2,690	2,713	3,136	3,571	3,594	4,017
26	144	1,005	1,478	1,513	1,986	2,009	2,494	2,967	2,990	3,013	3,486	3,971	3,994	4,467

RIPPLEFOLD: 120% Fullness — Lined (Lining 01000)

Pricing for butt or overlap master panels with 4" hem (additional charge for larger hems). Sizes and series numbers beyond what is listed below are available—please submit these quote requests via fax or email.

Series	Length	Finished Pair or Panel Width													
		36"	48"	60"	72"	84"	96"	108"	120"	132"	144"	156"	168"	180"	
07	36	277	365	437	525	553	655	744	801	829	918	1,020	1,078	1,136	
07	48	298	397	468	567	595	708	807	864	892	991	1,104	1,162	1,231	
07	60	298	397	468	567	595	708	807	864	892	991	1,104	1,162	1,231	
07	72	319	428	500	609	637	760	870	927	955	1,065	1,188	1,246	1,325	
07	84	340	460	531	651	679	813	933	990	1,018	1,138	1,272	1,330	1,420	
07	96	340	460	531	651	679	813	933	990	1,018	1,138	1,272	1,330	1,420	
07	101	361	491	563	693	721	865	996	1,053	1,081	1,212	1,356	1,414	1,514	
08	36	292	388	459	555	583	693	789	846	874	970	1,080	1,138	1,204	
08	48	318	427	498	607	635	758	867	924	952	1,061	1,184	1,242	1,321	
08	60	318	427	498	607	635	758	867	924	952	1,061	1,184	1,242	1,321	
08	72	344	466	537	659	687	823	945	1,002	1,030	1,152	1,288	1,346	1,438	
08	84	370	505	576	711	739	888	1,023	1,080	1,108	1,243	1,392	1,450	1,555	
08	96	370	505	576	711	739	888	1,023	1,080	1,108	1,243	1,392	1,450	1,555	
08	101	396	544	615	763	791	953	1,101	1,158	1,186	1,334	1,496	1,554	1,672	
09	36	304	406	477	579	607	723	825	882	910	1,012	1,128	1,186	1,258	
09	48	334	451	522	639	667	798	915	972	1,000	1,117	1,248	1,306	1,393	
09	60	334	451	522	639	667	798	915	972	1,000	1,117	1,248	1,306	1,393	
09	72	364	496	567	699	727	873	1,005	1,062	1,090	1,222	1,368	1,426	1,528	
09	84	394	541	612	759	787	948	1,095	1,152	1,180	1,327	1,488	1,546	1,663	
09	96	394	541	612	759	787	948	1,095	1,152	1,180	1,327	1,488	1,546	1,663	
09	101	424	586	657	819	847	1,023	1,185	1,242	1,270	1,432	1,608	1,666	1,798	
10	36	316	424	495	603	631	753	861	918	946	1,054	1,176	1,234	1,312	
10	48	350	475	546	671	699	838	963	1,020	1,048	1,173	1,312	1,370	1,465	
10	60	350	475	546	671	699	838	963	1,020	1,048	1,173	1,312	1,370	1,465	
10	72	384	526	597	739	767	923	1,065	1,122	1,150	1,292	1,448	1,506	1,618	
10	84	418	577	648	807	835	1,008	1,167	1,224	1,252	1,411	1,584	1,642	1,771	
10	96	418	577	648	807	835	1,008	1,167	1,224	1,252	1,411	1,584	1,642	1,771	
10	101	452	628	699	875	903	1,093	1,269	1,326	1,354	1,530	1,720	1,778	1,924	
11	36	328	442	513	627	655	783	897	954	982	1,096	1,224	1,282	1,366	
11	48	366	499	570	703	731	878	1,011	1,068	1,096	1,229	1,376	1,434	1,537	
11	60	366	499	570	703	731	878	1,011	1,068	1,096	1,229	1,376	1,434	1,537	
11	72	404	556	627	779	807	973	1,125	1,182	1,210	1,362	1,528	1,586	1,708	
11	84	442	613	684	855	883	1,068	1,239	1,296	1,324	1,495	1,680	1,738	1,879	
11	96	442	613	684	855	883	1,068	1,239	1,296	1,324	1,495	1,680	1,738	1,879	
11	101	480	670	741	931	959	1,163	1,353	1,410	1,438	1,628	1,832	1,890	2,050	
12	36	340	460	531	651	679	813	933	990	1,018	1,138	1,272	1,330	1,420	
12	48	382	523	594	735	763	918	1,059	1,116	1,144	1,285	1,440	1,498	1,609	
12	60	382	523	594	735	763	918	1,059	1,116	1,144	1,285	1,440	1,498	1,609	
12	72	424	586	657	819	847	1,023	1,185	1,242	1,270	1,432	1,608	1,666	1,798	
12	84	466	649	720	903	931	1,128	1,311	1,368	1,396	1,579	1,776	1,834	1,987	
12	96	466	649	720	903	931	1,128	1,311	1,368	1,396	1,579	1,776	1,834	1,987	
12	101	508	712	783	987	1,015	1,233	1,437	1,494	1,522	1,726	1,944	2,002	2,176	
13	36	352	478	549	675	703	843	969	1,026	1,054	1,180	1,320	1,378	1,474	
13	48	398	547	618	767	795	958	1,107	1,164	1,192	1,341	1,504	1,562	1,681	
13	60	398	547	618	767	795	958	1,107	1,164	1,192	1,341	1,504	1,562	1,681	
13	72	444	616	687	859	887	1,073	1,245	1,302	1,330	1,502	1,688	1,746	1,888	
13	84	490	685	756	951	979	1,188	1,383	1,440	1,468	1,663	1,872	1,930	2,095	
13	96	490	685	756	951	979	1,188	1,383	1,440	1,468	1,663	1,872	1,930	2,095	
13	101	536	754	825	1,043	1,071	1,303	1,521	1,578	1,606	1,824	2,056	2,114	2,302	
14	36	364	496	567	699	727	873	1,005	1,062	1,090	1,222	1,368	1,426	1,528	
14	48	414	571	642	799	827	998	1,155	1,212	1,240	1,397	1,568	1,626	1,753	
14	60	414	571	642	799	827	998	1,155	1,212	1,240	1,397	1,568	1,626	1,753	
14	72	464	646	717	899	927	1,123	1,305	1,362	1,390	1,572	1,768	1,826	1,978	
14	84	514	721	792	999	1,027	1,248	1,455	1,512	1,540	1,747	1,968	2,026	2,203	
14	96	514	721	792	999	1,027	1,248	1,455	1,512	1,540	1,747	1,968	2,026	2,203	
14	101	564	796	867	1,099	1,127	1,373	1,605	1,662	1,690	1,922	2,168	2,226	2,428	
15	36	376	514	585	723	751	903	1,041	1,098	1,126	1,264	1,416	1,474	1,582	
15	48	430	595	666	831	859	1,038	1,203	1,260	1,288	1,453	1,632	1,690	1,825	
15	60	430	595	666	831	859	1,038	1,203	1,260	1,288	1,453	1,632	1,690	1,825	
15	72	484	676	747	939	967	1,173	1,365	1,422	1,450	1,642	1,848	1,906	2,068	
15	84	538	757	828	1,047	1,075	1,308	1,527	1,584	1,612	1,831	2,064	2,122	2,311	
15	96	538	757	828	1,047	1,075	1,308	1,527	1,584	1,612	1,831	2,064	2,122	2,311	
15	101	592	838	909	1,155	1,183	1,443	1,689	1,746	1,774	2,020	2,280	2,338	2,554	
16	36	388	532	603	747	775	933	1,077	1,134	1,162	1,306	1,464	1,522	1,636	
16	48	446	619	690	863	891	1,078	1,251	1,308	1,336	1,509	1,696	1,754	1,897	
16	60	446	619	690	863	891	1,078	1,251	1,308	1,336	1,509	1,696	1,754	1,897	
16	72	504	706	777	979	1,007	1,223	1,425	1,482	1,510	1,712	1,928	1,986	2,158	
16	84	562	793	864	1,095	1,123	1,368	1,599	1,656	1,684	1,915	2,160	2,218	2,419	
16	96	562	793	864	1,095	1,123	1,368	1,599	1,656	1,684	1,915	2,160	2,218	2,419	
16	101	620	880	951	1,211	1,239	1,513	1,773	1,830	1,858	2,118	2,392	2,450	2,680	

RIPPLEFOLD: 120% Fullness — Lined (Lining 01000)

Pricing for butt or overlap master panels with 4" hem (additional charge for larger hems). Sizes and series numbers beyond what is listed below are available—please submit these quote requests via fax or email.

Series	Length	Finished Pair or Panel Width												
		36"	48"	60"	72"	84"	96"	108"	120"	132"	144"	156"	168"	180"
17	36	400	550	621	771	799	963	1,113	1,170	1,198	1,348	1,512	1,570	1,690
17	48	462	643	714	895	923	1,118	1,299	1,356	1,384	1,565	1,760	1,818	1,969
17	60	462	643	714	895	923	1,118	1,299	1,356	1,384	1,565	1,760	1,818	1,969
17	72	524	736	807	1,019	1,047	1,273	1,485	1,542	1,570	1,782	2,008	2,066	2,248
17	84	586	829	900	1,143	1,171	1,428	1,671	1,728	1,756	1,999	2,256	2,314	2,527
17	96	586	829	900	1,143	1,171	1,428	1,671	1,728	1,756	1,999	2,256	2,314	2,527
17	101	648	922	993	1,267	1,295	1,583	1,857	1,914	1,942	2,216	2,504	2,562	2,806
18	36	412	568	639	795	823	993	1,149	1,206	1,234	1,390	1,560	1,618	1,744
18	48	478	667	738	927	955	1,158	1,347	1,404	1,432	1,621	1,824	1,882	2,041
18	60	478	667	738	927	955	1,158	1,347	1,404	1,432	1,621	1,824	1,882	2,041
18	72	544	766	837	1,059	1,087	1,323	1,545	1,602	1,630	1,852	2,088	2,146	2,338
18	84	610	865	936	1,191	1,219	1,488	1,743	1,800	1,828	2,083	2,352	2,410	2,635
18	96	610	865	936	1,191	1,219	1,488	1,743	1,800	1,828	2,083	2,352	2,410	2,635
18	101	676	964	1,035	1,323	1,351	1,653	1,941	1,998	2,026	2,314	2,616	2,674	2,932
19	36	424	586	657	819	847	1,023	1,185	1,242	1,270	1,432	1,608	1,666	1,798
19	48	494	691	762	959	987	1,198	1,395	1,452	1,480	1,677	1,888	1,946	2,113
19	60	494	691	762	959	987	1,198	1,395	1,452	1,480	1,677	1,888	1,946	2,113
19	72	564	796	867	1,099	1,127	1,373	1,605	1,662	1,690	1,922	2,168	2,226	2,428
19	84	634	901	972	1,239	1,267	1,548	1,815	1,872	1,900	2,167	2,448	2,506	2,743
19	96	634	901	972	1,239	1,267	1,548	1,815	1,872	1,900	2,167	2,448	2,506	2,743
19	101	704	1,006	1,077	1,379	1,407	1,723	2,025	2,082	2,110	2,412	2,728	2,786	3,058
20	36	436	604	675	843	871	1,053	1,221	1,278	1,306	1,474	1,656	1,714	1,852
20	48	510	715	786	991	1,019	1,238	1,443	1,500	1,528	1,733	1,952	2,010	2,185
20	60	510	715	786	991	1,019	1,238	1,443	1,500	1,528	1,733	1,952	2,010	2,185
20	72	584	826	897	1,139	1,167	1,423	1,665	1,722	1,750	1,992	2,248	2,306	2,518
20	84	658	937	1,008	1,287	1,315	1,608	1,887	1,944	1,972	2,251	2,544	2,602	2,851
20	96	658	937	1,008	1,287	1,315	1,608	1,887	1,944	1,972	2,251	2,544	2,602	2,851
20	101	732	1,048	1,119	1,435	1,463	1,793	2,109	2,166	2,194	2,510	2,840	2,898	3,184
21	36	448	622	693	867	895	1,083	1,257	1,314	1,342	1,516	1,704	1,762	1,906
21	48	526	739	810	1,023	1,051	1,278	1,491	1,548	1,576	1,789	2,016	2,074	2,257
21	60	526	739	810	1,023	1,051	1,278	1,491	1,548	1,576	1,789	2,016	2,074	2,257
21	72	604	856	927	1,179	1,207	1,473	1,725	1,782	1,810	2,062	2,328	2,386	2,608
21	84	682	973	1,044	1,335	1,363	1,668	1,959	2,016	2,044	2,335	2,640	2,698	2,959
21	96	682	973	1,044	1,335	1,363	1,668	1,959	2,016	2,044	2,335	2,640	2,698	2,959
21	101	760	1,090	1,161	1,491	1,519	1,863	2,193	2,250	2,278	2,608	2,952	3,010	3,310
22	36	460	640	711	891	919	1,113	1,293	1,350	1,378	1,558	1,752	1,810	1,960
22	48	542	763	834	1,055	1,083	1,318	1,539	1,596	1,624	1,845	2,080	2,138	2,329
22	60	542	763	834	1,055	1,083	1,318	1,539	1,596	1,624	1,845	2,080	2,138	2,329
22	72	624	886	957	1,219	1,247	1,523	1,785	1,842	1,870	2,132	2,408	2,466	2,698
22	84	706	1,009	1,080	1,383	1,411	1,728	2,031	2,088	2,116	2,419	2,736	2,794	3,067
22	96	706	1,009	1,080	1,383	1,411	1,728	2,031	2,088	2,116	2,419	2,736	2,794	3,067
22	101	788	1,132	1,203	1,547	1,575	1,933	2,277	2,334	2,362	2,706	3,064	3,122	3,436
23	36	472	658	729	915	943	1,143	1,329	1,386	1,414	1,600	1,800	1,858	2,014
23	48	558	787	858	1,087	1,115	1,358	1,587	1,644	1,672	1,901	2,144	2,202	2,401
23	60	558	787	858	1,087	1,115	1,358	1,587	1,644	1,672	1,901	2,144	2,202	2,401
23	72	644	916	987	1,259	1,287	1,573	1,845	1,902	1,930	2,202	2,488	2,546	2,788
23	84	730	1,045	1,116	1,431	1,459	1,788	2,103	2,160	2,188	2,503	2,832	2,890	3,175
23	96	730	1,045	1,116	1,431	1,459	1,788	2,103	2,160	2,188	2,503	2,832	2,890	3,175
23	101	816	1,174	1,245	1,603	1,631	2,003	2,361	2,418	2,446	2,804	3,176	3,234	3,562
24	36	484	676	747	939	967	1,173	1,365	1,422	1,450	1,642	1,848	1,906	2,068
24	48	574	811	882	1,119	1,147	1,398	1,635	1,692	1,720	1,957	2,208	2,266	2,473
24	60	574	811	882	1,119	1,147	1,398	1,635	1,692	1,720	1,957	2,208	2,266	2,473
24	72	664	946	1,017	1,299	1,327	1,623	1,905	1,962	1,990	2,272	2,568	2,626	2,878
24	84	754	1,081	1,152	1,479	1,507	1,848	2,175	2,232	2,260	2,587	2,928	2,986	3,283
24	96	754	1,081	1,152	1,479	1,507	1,848	2,175	2,232	2,260	2,587	2,928	2,986	3,283
24	101	844	1,216	1,287	1,659	1,687	2,073	2,445	2,502	2,530	2,902	3,288	3,346	3,688
25	36	502	703	774	975	1,003	1,218	1,419	1,476	1,504	1,705	1,920	1,978	2,149
25	48	598	847	918	1,167	1,195	1,458	1,707	1,764	1,792	2,041	2,304	2,362	2,581
25	60	598	847	918	1,167	1,195	1,458	1,707	1,764	1,792	2,041	2,304	2,362	2,581
25	72	694	991	1,062	1,359	1,387	1,698	1,995	2,052	2,080	2,377	2,688	2,746	3,013
25	84	790	1,135	1,206	1,551	1,579	1,938	2,283	2,340	2,368	2,713	3,072	3,130	3,445
25	96	790	1,135	1,206	1,551	1,579	1,938	2,283	2,340	2,368	2,713	3,072	3,130	3,445
25	101	886	1,279	1,350	1,743	1,771	2,178	2,571	2,628	2,656	3,049	3,456	3,514	3,877
26	36	514	721	792	999	1,027	1,248	1,455	1,512	1,540	1,747	1,968	2,026	2,203
26	48	614	871	942	1,199	1,227	1,498	1,755	1,812	1,840	2,097	2,368	2,426	2,653
26	60	614	871	942	1,199	1,227	1,498	1,755	1,812	1,840	2,097	2,368	2,426	2,653
26	72	714	1,021	1,092	1,399	1,427	1,748	2,055	2,112	2,140	2,447	2,768	2,826	3,103
26	84	814	1,171	1,242	1,599	1,627	1,998	2,355	2,412	2,440	2,797	3,168	3,226	3,553
26	96	814	1,171	1,242	1,599	1,627	1,998	2,355	2,412	2,440	2,797	3,168	3,226	3,553
26	101	914	1,321	1,392	1,799	1,827	2,248	2,655	2,712	2,740	3,147	3,568	3,626	4,003

PANEL GLIDE: Unlined

Chart pricing for fabric panels only. For complete panel glide systems, please see hardware pricing on page 31. Sizes and series numbers beyond what is listed in the charts below are available—please submit these quote requests via fax or email.

Series	Length	Panel Width															
		18	20	22	24	26	28	30	32	34	36	38	40	42	44	46	48
07	48	51	56	61	67	72	77	82	88	93	98	103	109	114	119	124	130
07	60	61	67	73	80	86	92	98	105	111	117	124	130	136	142	149	155
07	72	71	78	85	93	100	107	114	122	129	136	144	151	158	166	173	180
07	84	81	89	97	106	114	122	131	139	147	156	164	172	180	189	197	205
07	96	90	100	109	119	128	137	147	156	165	175	184	193	203	212	221	231
07	102	95	105	115	125	135	145	155	164	174	184	194	204	214	224	234	243
07	117	107	118	130	141	152	163	174	185	196	207	218	230	241	252	263	274
08	48	54	60	65	71	76	82	87	93	98	104	109	115	120	126	131	137
08	60	65	71	78	84	91	98	104	111	118	124	131	137	144	151	157	164
08	72	75	83	91	98	106	114	122	129	137	145	152	160	168	175	183	191
08	84	86	95	104	112	121	130	139	147	156	165	174	183	191	200	209	218
08	96	97	106	116	126	136	146	156	166	176	185	195	205	215	225	235	245
08	102	102	112	123	133	144	154	164	175	185	196	206	217	227	237	248	258
08	117	115	126	138	150	162	173	185	197	209	220	232	244	256	267	279	291
09	48	57	62	68	74	80	85	91	97	103	108	114	120	126	131	137	143
09	60	68	75	82	88	95	102	109	116	123	130	137	144	150	157	164	171
09	72	79	87	95	103	111	119	127	135	143	151	159	167	175	183	191	199
09	84	90	99	109	118	127	136	145	154	164	173	182	191	200	209	218	228
09	96	101	112	122	132	143	153	163	174	184	194	204	215	225	235	246	256
09	102	107	118	129	140	151	161	172	183	194	205	216	227	237	248	259	270
09	117	121	133	145	157	170	182	194	206	219	231	243	255	268	280	292	304
10	48	59	65	71	77	83	89	95	101	107	113	119	125	131	137	143	149
10	60	71	78	85	92	100	107	114	121	128	135	142	150	157	164	171	178
10	72	83	91	99	108	116	124	133	141	149	158	166	174	183	191	200	208
10	84	95	104	114	123	133	142	152	161	171	180	190	199	209	218	228	237
10	96	106	117	128	138	149	160	171	181	192	203	214	224	235	246	256	267
10	102	112	124	135	146	157	169	180	191	203	214	225	237	248	259	271	282
10	117	127	139	152	165	177	190	203	216	228	241	254	267	279	292	305	318
11	48	62	68	74	80	86	93	99	105	111	117	123	130	136	142	148	154
11	60	74	81	89	96	104	111	119	126	133	141	148	156	163	171	178	185
11	72	86	95	104	112	121	130	138	147	156	164	173	182	190	199	208	216
11	84	99	109	119	129	138	148	158	168	178	188	198	208	218	228	237	247
11	96	111	122	133	145	156	167	178	189	200	211	223	234	245	256	267	278
11	102	117	129	141	153	164	176	188	200	211	223	235	247	258	270	282	294
11	117	132	146	159	172	185	199	212	225	238	252	265	278	291	305	318	331
12	48	64	71	77	83	90	96	103	109	115	122	128	135	141	147	154	160
12	60	77	85	93	100	108	116	123	131	139	146	154	162	169	177	185	193
12	72	90	99	108	117	126	135	144	153	162	171	180	189	198	207	216	225
12	84	103	113	124	134	144	154	165	175	185	196	206	216	226	237	247	257
12	96	116	128	139	151	162	174	185	197	209	220	232	243	255	266	278	289
12	102	123	135	147	159	171	184	196	208	220	232	245	257	269	281	293	306
12	117	138	152	166	180	193	207	221	235	248	262	276	290	303	317	331	345
13	48	67	73	80	87	93	100	106	113	120	126	133	140	146	153	159	166
13	60	80	88	96	104	112	120	128	136	144	152	160	168	176	184	192	200
13	72	94	103	112	122	131	140	150	159	168	178	187	196	205	215	224	233
13	84	107	118	129	139	150	161	171	182	193	203	214	224	235	246	256	267
13	96	121	133	145	157	169	181	193	205	217	229	241	253	265	277	289	301
13	102	128	140	153	166	178	191	204	216	229	242	254	267	280	292	305	317
13	117	144	158	173	187	201	215	230	244	258	273	287	301	315	330	344	358
14	48	69	76	83	90	97	103	110	117	124	131	138	145	151	158	165	172
14	60	83	92	100	108	116	125	133	141	149	157	166	174	182	190	199	207
14	72	98	107	117	126	136	146	155	165	175	184	194	203	213	223	232	242
14	84	112	123	134	145	156	167	178	189	200	211	222	233	244	255	266	277
14	96	126	138	151	163	175	188	200	213	225	237	250	262	275	287	299	312
14	102	133	146	159	172	185	198	212	225	238	251	264	277	290	303	316	329
14	117	150	165	180	194	209	224	239	253	268	283	298	313	327	342	357	372
15	48	72	79	86	93	100	107	114	121	128	135	142	149	157	164	171	178
15	60	87	95	104	112	121	129	138	146	155	163	172	180	189	197	206	214
15	72	101	111	121	131	141	151	161	171	181	191	201	211	221	230	240	250
15	84	116	127	139	150	162	173	184	196	207	218	230	241	253	264	275	287
15	96	131	144	156	169	182	195	208	220	233	246	259	272	285	297	310	323
15	102	138	152	165	179	192	206	219	233	246	260	274	287	301	314	328	341
15	117	156	171	186	202	217	232	248	263	278	293	309	324	339	355	370	385
16	48	74	82	89	96	103	111	118	125	133	140	147	154	162	169	176	184
16	60	90	98	107	116	125	134	142	151	160	169	177	186	195	204	212	221
16	72	105	115	126	136	146	156	167	177	187	197	208	218	228	238	249	259
16	84	120	132	144	156	167	179	191	203	214	226	238	250	261	273	285	297
16	96	136	149	162	175	189	202	215	228	242	255	268	281	294	308	321	334
16	102	143	157	171	185	199	213	227	241	255	269	283	297	311	325	339	353
16	117	162	178	193	209	225	241	257	272	288	304	320	335	351	367	383	399

PANEL GLIDE: Unlined

Chart pricing for fabric panels only. For complete panel glide systems, please see hardware pricing on page 31. Sizes and series numbers beyond what is listed in the charts below are available—please submit these quote requests via fax or email.

Series	Length	Panel Width															
		18	20	22	24	26	28	30	32	34	36	38	40	42	44	46	48
17	48	77	84	92	99	107	114	122	129	137	144	152	159	167	174	182	189
17	60	93	102	111	120	129	138	147	156	165	174	183	192	201	210	219	228
17	72	109	119	130	140	151	162	172	183	193	204	214	225	236	246	257	267
17	84	125	137	149	161	173	185	197	209	222	234	246	258	270	282	294	306
17	96	141	154	168	181	195	209	222	236	250	263	277	291	304	318	332	345
17	102	148	163	177	192	206	221	235	249	264	278	293	307	322	336	350	365
17	117	168	184	200	217	233	249	265	282	298	314	331	347	363	379	396	412
18	48	79	87	95	103	110	118	126	133	141	149	157	164	172	180	187	195
18	60	96	105	115	124	133	142	152	161	170	180	189	198	208	217	226	236
18	72	112	123	134	145	156	167	178	189	200	211	221	232	243	254	265	276
18	84	129	141	154	166	179	191	204	216	229	241	254	266	279	291	304	316
18	96	145	159	174	188	202	216	230	244	258	272	286	300	314	328	343	357
18	102	154	169	183	198	213	228	243	258	273	288	302	317	332	347	362	377
18	117	174	190	207	224	241	258	274	291	308	325	342	358	375	392	409	426
19	48	82	90	98	106	114	122	130	138	145	153	161	169	177	185	193	201
19	60	99	109	118	128	137	147	157	166	176	185	195	204	214	224	233	243
19	72	116	127	139	150	161	172	183	195	206	217	228	240	251	262	273	284
19	84	133	146	159	172	185	198	210	223	236	249	262	275	288	300	313	326
19	96	150	165	179	194	208	223	237	252	266	281	295	310	324	339	353	368
19	102	159	174	189	205	220	235	251	266	281	297	312	327	343	358	373	389
19	117	179	197	214	231	249	266	283	301	318	335	352	370	387	404	422	439
20	48	85	93	101	109	117	125	133	142	150	158	166	174	182	191	199	207
20	60	102	112	122	132	142	151	161	171	181	191	201	211	220	230	240	250
20	72	120	131	143	154	166	178	189	201	212	224	235	247	258	270	281	293
20	84	138	151	164	177	190	204	217	230	243	257	270	283	296	309	323	336
20	96	155	170	185	200	215	230	245	260	275	289	304	319	334	349	364	379
20	102	164	180	196	211	227	243	259	274	290	306	322	337	353	369	385	400
20	117	185	203	221	239	257	274	292	310	328	346	363	381	399	417	435	452
21	48	87	95	104	112	121	129	137	146	154	162	171	179	188	196	204	213
21	60	105	115	126	136	146	156	166	176	186	196	206	217	227	237	247	257
21	72	124	135	147	159	171	183	195	207	218	230	242	254	266	278	290	301
21	84	142	155	169	183	196	210	223	237	251	264	278	291	305	319	332	346
21	96	160	175	191	206	221	237	252	267	283	298	313	329	344	359	375	390
21	102	169	185	202	218	234	250	266	283	299	315	331	347	364	380	396	412
21	117	191	210	228	246	264	283	301	319	338	356	374	393	411	429	448	466
22	48	90	98	107	115	124	133	141	150	158	167	176	184	193	201	210	219
22	60	108	119	129	140	150	160	171	181	192	202	212	223	233	243	254	264
22	72	127	139	152	164	176	188	200	213	225	237	249	261	273	286	298	310
22	84	146	160	174	188	202	216	230	244	258	272	286	300	314	328	342	356
22	96	165	181	196	212	228	244	259	275	291	307	323	338	354	370	386	401
22	102	174	191	208	224	241	258	274	291	308	324	341	358	374	391	408	424
22	117	197	216	235	254	272	291	310	329	348	366	385	404	423	442	461	479
23	48	92	101	110	119	127	136	145	154	163	171	180	189	198	207	216	224
23	60	112	122	133	144	154	165	176	186	197	207	218	229	239	250	261	271
23	72	131	143	156	168	181	193	206	218	231	243	256	268	281	293	306	318
23	84	150	165	179	193	208	222	236	251	265	279	294	308	322	337	351	365
23	96	170	186	202	218	235	251	267	283	299	315	332	348	364	380	396	413
23	102	180	197	214	231	248	265	282	299	316	333	351	368	385	402	419	436
23	117	203	222	242	261	280	300	319	338	358	377	396	416	435	454	474	493
24	48	95	104	113	122	131	140	149	158	167	176	185	194	203	212	221	230
24	60	115	126	137	147	158	169	180	191	202	213	224	235	246	257	268	279
24	72	135	148	160	173	186	199	212	224	237	250	263	276	288	301	314	327
24	84	155	169	184	199	214	228	243	258	272	287	302	316	331	346	361	375
24	96	175	191	208	225	241	258	274	291	308	324	341	357	374	391	407	424
24	102	185	202	220	237	255	272	290	308	325	343	360	378	395	413	430	448
24	117	209	229	249	268	288	308	328	348	368	387	407	427	447	467	487	506
25	48	99	108	117	127	136	145	155	164	173	183	192	201	211	220	230	239
25	60	119	131	142	153	165	176	187	199	210	221	233	244	255	267	278	289
25	72	140	154	167	180	193	207	220	233	247	260	273	287	300	313	326	340
25	84	161	176	192	207	222	237	253	268	283	299	314	329	344	360	375	390
25	96	182	199	216	234	251	268	285	303	320	337	354	372	389	406	423	440
25	102	192	211	229	247	265	284	302	320	338	356	375	393	411	429	447	466
25	117	218	238	259	279	300	321	341	362	382	403	424	444	465	485	506	527
26	48	101	111	120	130	139	149	159	168	178	187	197	206	216	226	235	245
26	60	123	134	146	157	169	181	192	204	215	227	238	250	262	273	285	296
26	72	144	158	171	185	198	212	226	239	253	267	280	294	307	321	335	348
26	84	165	181	197	212	228	244	259	275	291	306	322	337	353	369	384	400
26	96	187	205	222	240	258	275	293	310	328	346	363	381	399	416	434	452
26	102	198	216	235	254	272	291	310	328	347	366	384	403	422	440	459	478
26	117	224	245	266	287	308	329	350	371	392	413	435	456	477	498	519	540

PANEL GLIDE: Lined (Lining 01000)

Chart pricing for fabric panels only. For complete panel glide systems, please see hardware pricing on page 31. Sizes and series numbers beyond what is listed in the charts below are available—please submit these quote requests via fax or email.

Series	Length	Panel Width															
		18	20	22	24	26	28	30	32	34	36	38	40	42	44	46	48
07	48	57	63	69	75	81	87	93	100	106	112	118	124	130	136	143	149
07	60	68	75	83	90	97	105	112	120	127	134	142	149	156	164	171	179
07	72	79	88	96	105	114	122	131	139	148	157	165	174	183	191	200	208
07	84	91	100	110	120	130	140	150	159	169	179	189	199	209	219	228	238
07	96	102	113	124	135	146	157	168	179	190	202	213	224	235	246	257	268
07	102	107	119	131	143	154	166	178	189	201	213	224	236	248	260	271	283
07	110	115	128	140	153	165	178	190	203	215	228	240	253	265	278	290	303
08	48	59	66	72	79	85	91	98	104	111	117	124	130	136	143	149	156
08	60	71	79	87	94	102	110	118	125	133	141	148	156	164	172	179	187
08	72	83	92	101	110	119	128	137	146	155	164	173	182	191	200	209	218
08	84	95	105	116	126	136	147	157	167	178	188	198	208	219	229	239	250
08	96	107	119	130	142	153	165	177	188	200	211	223	235	246	258	269	281
08	102	113	125	137	150	162	174	186	199	211	223	235	248	260	272	284	297
08	110	121	134	147	160	173	186	200	213	226	239	252	265	278	291	305	318
09	48	61	68	75	81	88	95	101	108	115	121	128	135	141	148	154	161
09	60	74	82	90	98	106	114	122	130	138	146	154	162	170	178	186	194
09	72	86	96	105	114	124	133	142	152	161	170	180	189	198	208	217	226
09	84	99	109	120	131	141	152	163	173	184	195	205	216	227	238	248	259
09	96	111	123	135	147	159	171	183	195	207	219	231	243	255	267	279	292
09	102	117	130	143	155	168	181	193	206	219	232	244	257	270	282	295	308
09	110	125	139	153	166	180	193	207	221	234	248	262	275	289	302	316	330
10	48	64	70	77	84	91	98	105	112	119	125	132	139	146	153	160	167
10	60	76	85	93	101	110	118	126	134	143	151	159	167	176	184	192	200
10	72	89	99	109	118	128	138	147	157	167	176	186	196	205	215	225	234
10	84	102	113	124	135	146	157	169	180	191	202	213	224	235	246	257	268
10	96	115	128	140	152	165	177	190	202	215	227	240	252	265	277	289	302
10	102	121	135	148	161	174	187	200	214	227	240	253	266	279	293	306	319
10	110	130	144	158	172	186	201	215	229	243	257	271	285	299	313	327	341
11	48	66	73	80	87	94	101	108	115	122	130	137	144	151	158	165	172
11	60	79	88	96	105	113	122	130	139	147	156	164	173	182	190	199	207
11	72	92	102	112	122	132	142	152	162	172	182	192	202	212	222	232	242
11	84	106	117	129	140	152	163	174	186	197	209	220	232	243	254	266	277
11	96	119	132	145	158	171	184	196	209	222	235	248	261	274	287	300	312
11	102	126	139	153	167	180	194	207	221	235	248	262	276	289	303	316	330
11	110	135	149	164	178	193	208	222	237	251	266	280	295	310	324	339	353
12	48	68	75	82	90	97	104	112	119	126	134	141	148	156	163	170	178
12	60	82	91	99	108	117	126	135	143	152	161	170	179	187	196	205	214
12	72	96	106	116	126	137	147	157	168	178	188	199	209	219	230	240	250
12	84	109	121	133	145	157	168	180	192	204	216	227	239	251	263	275	287
12	96	123	137	150	163	176	190	203	216	230	243	256	270	283	296	310	323
12	102	130	144	158	172	186	200	214	229	243	257	271	285	299	313	327	341
12	110	139	154	169	185	200	215	230	245	260	275	290	305	320	335	350	365
13	48	70	78	85	93	100	108	115	123	130	138	145	153	160	168	176	183
13	60	84	93	103	112	121	130	139	148	157	166	175	184	193	202	212	221
13	72	99	109	120	131	141	152	162	173	184	194	205	216	226	237	248	258
13	84	113	125	137	150	162	174	186	198	210	223	235	247	259	271	284	296
13	96	127	141	155	168	182	196	210	223	237	251	265	278	292	306	320	333
13	102	134	149	163	178	192	207	221	236	251	265	280	294	309	323	338	352
13	110	144	160	175	191	206	222	237	253	268	284	299	315	330	346	362	377
14	48	72	80	88	95	103	111	119	126	134	142	150	158	165	173	181	189
14	60	87	96	106	115	124	134	143	152	162	171	181	190	199	209	218	227
14	72	102	113	124	135	146	157	168	178	189	200	211	222	233	244	255	266
14	84	117	129	142	154	167	179	192	204	217	230	242	255	267	280	292	305
14	96	131	146	160	174	188	202	216	230	245	259	273	287	301	315	330	344
14	102	139	154	169	184	199	214	229	243	258	273	288	303	318	333	348	363
14	110	149	165	181	197	213	229	245	261	277	293	309	325	341	357	373	389
15	48	74	82	90	98	106	114	122	130	138	146	154	162	170	178	186	194
15	60	90	99	109	118	128	138	147	157	167	176	186	196	205	215	224	234
15	72	105	116	127	139	150	161	173	184	195	206	218	229	240	252	263	274
15	84	120	133	146	159	172	185	198	211	224	237	249	262	275	288	301	314
15	96	135	150	165	179	194	208	223	238	252	267	281	296	310	325	340	354
15	102	143	158	174	189	205	220	236	251	266	282	297	313	328	343	359	374
15	110	153	170	186	203	219	236	252	269	285	302	318	335	351	368	384	401
16	48	76	85	93	101	109	117	126	134	142	150	159	167	175	183	191	200
16	60	92	102	112	122	132	142	152	162	171	181	191	201	211	221	231	241
16	72	108	120	131	143	154	166	178	189	201	212	224	236	247	259	270	282
16	84	124	137	150	164	177	190	204	217	230	244	257	270	283	297	310	323
16	96	140	155	170	185	200	215	230	245	260	275	290	305	320	335	350	365
16	102	147	163	179	195	211	227	243	258	274	290	306	322	338	354	369	385
16	110	158	175	192	209	226	243	260	277	294	311	328	345	362	379	396	413

PANEL GLIDE: Lined (Lining 01000)

Chart pricing for fabric panels only. For complete panel glide systems, please see hardware pricing on page 31. Sizes and series numbers beyond what is listed in the charts below are available—please submit these quote requests via fax or email.

Series	Length	Panel Width															
		18	20	22	24	26	28	30	32	34	36	38	40	42	44	46	48
17	48	79	87	95	104	112	121	129	138	146	154	163	171	180	188	197	205
17	60	95	105	115	125	136	146	156	166	176	186	197	207	217	227	237	248
17	72	111	123	135	147	159	171	183	195	207	218	230	242	254	266	278	290
17	84	127	141	155	168	182	196	209	223	237	250	264	278	292	305	319	333
17	96	144	159	174	190	205	221	236	252	267	282	298	313	329	344	360	375
17	102	152	168	184	201	217	233	250	266	282	298	315	331	347	364	380	396
17	110	163	180	197	215	232	250	267	285	302	320	337	355	372	390	407	425
18	48	81	89	98	107	115	124	133	141	150	159	167	176	185	193	202	211
18	60	97	108	118	129	139	150	160	171	181	192	202	212	223	233	244	254
18	72	114	126	139	151	163	175	188	200	212	224	237	249	261	274	286	298
18	84	131	145	159	173	187	201	215	229	243	257	271	286	300	314	328	342
18	96	148	164	179	195	211	227	243	259	275	290	306	322	338	354	370	385
18	102	156	173	190	206	223	240	257	273	290	307	324	340	357	374	391	407
18	110	167	185	203	221	239	257	275	293	311	329	347	365	383	401	419	437
19	48	83	92	101	110	118	127	136	145	154	163	172	181	189	198	207	216
19	60	100	111	122	132	143	154	164	175	186	197	207	218	229	240	250	261
19	72	117	130	142	155	168	180	193	205	218	231	243	256	268	281	293	306
19	84	135	149	163	178	192	207	221	236	250	264	279	293	308	322	337	351
19	96	152	168	184	201	217	233	249	266	282	298	315	331	347	363	380	396
19	102	160	178	195	212	229	246	264	281	298	315	332	350	367	384	401	418
19	110	172	190	209	227	246	264	282	301	319	338	356	375	393	412	430	448
20	48	85	94	103	112	121	131	140	149	158	167	176	185	194	203	212	222
20	60	103	114	125	136	147	158	169	180	191	202	213	224	235	246	257	268
20	72	120	133	146	159	172	185	198	211	224	237	249	262	275	288	301	314
20	84	138	153	168	183	197	212	227	242	257	271	286	301	316	331	345	360
20	96	156	173	189	206	223	239	256	273	289	306	323	340	356	373	390	406
20	102	165	182	200	218	235	253	271	288	306	324	341	359	377	394	412	429
20	110	176	195	214	233	252	271	290	309	328	347	366	385	404	422	441	460
21	48	87	96	106	115	124	134	143	152	162	171	180	190	199	208	218	227
21	60	105	117	128	139	150	162	173	184	196	207	218	229	241	252	263	274
21	72	124	137	150	163	176	190	203	216	229	243	256	269	282	295	309	322
21	84	142	157	172	187	202	218	233	248	263	278	293	309	324	339	354	369
21	96	160	177	194	211	228	246	263	280	297	314	331	348	365	383	400	417
21	102	169	187	205	223	241	260	278	296	314	332	350	368	386	404	422	441
21	110	181	201	220	239	259	278	298	317	336	356	375	395	414	433	453	472
22	48	89	99	108	118	127	137	147	156	166	175	185	194	204	213	223	233
22	60	108	120	131	143	154	166	177	189	200	212	223	235	247	258	270	281
22	72	127	140	154	167	181	194	208	221	235	249	262	276	289	303	316	330
22	84	145	161	176	192	208	223	239	254	270	285	301	316	332	347	363	379
22	96	164	182	199	217	234	252	269	287	304	322	340	357	375	392	410	427
22	102	173	192	210	229	248	266	285	303	322	340	359	377	396	415	433	452
22	110	186	206	226	245	265	285	305	325	345	365	385	405	424	444	464	484
23	48	91	101	111	121	131	140	150	160	170	179	189	199	209	218	228	238
23	60	111	122	134	146	158	170	182	193	205	217	229	241	252	264	276	288
23	72	130	144	157	171	185	199	213	227	241	255	268	282	296	310	324	338
23	84	149	165	181	197	213	229	244	260	276	292	308	324	340	356	372	388
23	96	168	186	204	222	240	258	276	294	312	330	348	366	384	402	420	438
23	102	178	197	216	235	254	273	292	311	330	349	368	387	406	425	444	463
23	110	190	211	231	251	272	292	313	333	353	374	394	414	435	455	476	496
24	48	94	104	114	124	134	144	154	164	174	184	194	204	214	224	233	243
24	60	113	125	137	150	162	174	186	198	210	222	234	246	258	270	283	295
24	72	133	147	161	175	190	204	218	232	246	261	275	289	303	317	332	346
24	84	152	169	185	201	218	234	250	267	283	299	315	332	348	364	381	397
24	96	172	191	209	227	246	264	283	301	319	338	356	375	393	411	430	448
24	102	182	201	221	240	260	279	299	318	338	357	376	396	415	435	454	474
24	110	195	216	237	258	278	299	320	341	362	383	404	424	445	466	487	508
25	48	97	107	117	128	138	148	159	169	179	190	200	210	221	231	241	252
25	60	117	130	142	155	167	180	192	205	217	230	242	255	267	280	292	305
25	72	138	152	167	182	196	211	226	240	255	270	284	299	314	328	343	358
25	84	158	175	192	208	225	242	259	276	293	310	326	343	360	377	394	411
25	96	178	197	216	235	254	273	292	312	331	350	369	388	407	426	445	464
25	102	188	209	229	249	269	289	309	329	349	370	390	410	430	450	470	490
25	110	202	224	245	267	288	310	331	353	375	396	418	439	461	483	504	526
26	48	99	109	120	131	141	152	162	173	183	194	204	215	226	236	247	257
26	60	120	133	145	158	171	184	196	209	222	235	248	260	273	286	299	311
26	72	141	156	171	186	201	216	231	246	261	276	291	306	321	336	351	366
26	84	161	179	196	213	230	248	265	282	299	317	334	351	368	386	403	420
26	96	182	202	221	241	260	280	299	319	338	357	377	396	416	435	455	474
26	102	193	213	234	254	275	296	316	337	357	378	399	419	440	460	481	501
26	110	207	229	251	273	295	317	339	361	383	405	427	449	471	493	516	538

PANEL GLIDE: Self-Lined

Chart pricing for fabric panels only. For complete panel glide systems, please see hardware pricing on page 31. Sizes and series numbers beyond what is listed in the charts below are available—please submit these quote requests via fax or email.

Series	Length	Panel Width															
		18	20	22	24	26	28	30	32	34	36	38	40	42	44	46	48
07	48	66	73	80	87	94	101	108	115	122	130	137	144	151	158	165	172
07	60	79	88	96	105	113	122	130	139	147	156	164	173	182	190	199	207
07	72	92	102	112	122	132	142	152	162	172	182	192	202	212	222	232	242
07	84	106	117	129	140	152	163	174	186	197	209	220	232	243	254	266	277
07	96	119	132	145	158	171	184	196	209	222	235	248	261	274	287	300	312
07	102	126	139	153	167	180	194	207	221	235	248	262	276	289	303	316	330
07	117	142	157	173	188	203	219	234	249	265	280	296	311	326	342	357	372
08	48	71	79	86	94	102	109	117	125	132	140	148	155	163	171	178	186
08	60	86	95	104	113	123	132	141	150	159	169	178	187	196	206	215	224
08	72	100	111	122	133	143	154	165	176	187	197	208	219	230	241	251	262
08	84	115	127	140	152	164	177	189	201	214	226	238	251	263	276	288	300
08	96	129	143	157	171	185	199	213	227	241	255	269	283	297	311	325	339
08	102	137	151	166	181	196	210	225	240	254	269	284	299	313	328	343	358
08	117	154	171	187	204	221	237	254	271	287	304	321	337	354	370	387	404
09	48	75	83	92	100	108	116	124	132	140	148	156	164	173	181	189	197
09	60	91	101	110	120	130	140	150	159	169	179	189	198	208	218	228	237
09	72	106	118	129	141	152	164	175	187	198	209	221	232	244	255	267	278
09	84	122	135	148	161	174	188	201	214	227	240	253	266	279	293	306	319
09	96	137	152	167	182	197	211	226	241	256	271	285	300	315	330	345	359
09	102	145	161	176	192	208	223	239	255	270	286	302	317	333	348	364	380
09	117	164	182	199	217	235	252	270	288	305	323	341	358	376	394	411	429
10	48	80	88	97	105	114	122	131	139	148	157	165	174	182	191	199	208
10	60	96	106	117	127	137	148	158	168	179	189	199	210	220	230	241	251
10	72	113	125	137	149	161	173	185	197	209	221	234	246	258	270	282	294
10	84	129	143	157	171	185	198	212	226	240	254	268	282	296	309	323	337
10	96	146	161	177	193	208	224	239	255	271	286	302	318	333	349	365	380
10	102	154	170	187	203	220	237	253	270	286	303	319	336	352	369	385	402
10	117	174	192	211	230	249	267	286	305	323	342	361	379	398	417	435	454
11	48	84	93	102	111	120	129	138	147	156	165	174	183	192	201	210	219
11	60	101	112	123	134	145	156	167	177	188	199	210	221	232	243	254	264
11	72	119	132	144	157	170	183	195	208	221	234	246	259	272	284	297	310
11	84	136	151	166	180	195	209	224	239	253	268	282	297	312	326	341	356
11	96	154	170	187	203	220	236	253	269	286	302	319	335	352	368	385	401
11	102	163	180	197	215	232	250	267	285	302	319	337	354	372	389	407	424
11	117	184	203	223	243	262	282	302	321	341	361	381	400	420	440	459	479
12	48	88	98	107	117	126	135	145	154	164	173	183	192	201	211	220	230
12	60	107	118	129	141	152	164	175	187	198	209	221	232	244	255	266	278
12	72	125	138	152	165	179	192	205	219	232	246	259	272	286	299	313	326
12	84	144	159	174	190	205	220	236	251	266	282	297	313	328	343	359	374
12	96	162	179	197	214	231	249	266	283	301	318	335	353	370	387	405	422
12	102	171	189	208	226	244	263	281	299	318	336	354	373	391	409	428	446
12	117	193	214	235	256	276	297	318	338	359	380	401	421	442	463	483	504
13	48	93	102	112	122	132	142	152	162	172	181	191	201	211	221	231	241
13	60	112	124	136	148	160	172	184	196	208	220	231	243	255	267	279	291
13	72	131	145	159	173	187	201	216	230	244	258	272	286	300	314	328	342
13	84	151	167	183	199	215	231	247	263	280	296	312	328	344	360	376	392
13	96	170	188	206	225	243	261	279	297	316	334	352	370	388	407	425	443
13	102	180	199	218	237	257	276	295	314	334	353	372	391	411	430	449	468
13	117	203	225	247	268	290	312	334	355	377	399	421	442	464	486	508	529
14	48	97	107	117	128	138	148	159	169	179	190	200	210	221	231	241	252
14	60	117	130	142	155	167	180	192	205	217	230	242	255	267	280	292	305
14	72	138	152	167	182	196	211	226	240	255	270	284	299	314	328	343	358
14	84	158	175	192	208	225	242	259	276	293	310	326	343	360	377	394	411
14	96	178	197	216	235	254	273	292	312	331	350	369	388	407	426	445	464
14	102	188	209	229	249	269	289	309	329	349	370	390	410	430	450	470	490
14	117	213	236	259	281	304	327	350	372	395	418	441	463	486	509	532	554
15	48	101	112	123	133	144	155	166	177	187	198	209	220	230	241	252	263
15	60	122	135	149	162	175	188	201	214	227	240	253	266	279	292	305	318
15	72	144	159	174	190	205	220	236	251	266	282	297	312	328	343	358	374
15	84	165	183	200	218	235	253	271	288	306	324	341	359	376	394	412	429
15	96	186	206	226	246	266	286	306	326	345	365	385	405	425	445	465	485
15	102	197	218	239	260	281	302	323	344	365	386	407	428	449	470	491	512
15	117	223	247	270	294	318	342	365	389	413	437	461	484	508	532	556	580
16	48	105	117	128	139	150	161	173	184	195	206	218	229	240	251	262	274
16	60	128	141	155	168	182	196	209	223	236	250	264	277	291	304	318	332
16	72	150	166	182	198	214	230	246	262	278	294	310	326	342	358	374	390
16	84	172	191	209	227	246	264	282	301	319	337	356	374	393	411	429	448
16	96	195	215	236	257	277	298	319	340	360	381	402	423	443	464	485	506
16	102	206	228	250	271	293	315	337	359	381	403	425	447	469	491	513	535
16	117	233	257	282	307	332	357	381	406	431	456	481	505	530	555	580	605

PANEL GLIDE: Self-Lined

Chart pricing for fabric panels only. For complete panel glide systems, please see hardware pricing on page 31. Sizes and series numbers beyond what is listed in the charts below are available—please submit these quote requests via fax or email.

Series	Length	Panel Width															
		18	20	22	24	26	28	30	32	34	36	38	40	42	44	46	48
17	48	110	121	133	145	156	168	180	191	203	215	226	238	250	261	273	285
17	60	133	147	161	175	190	204	218	232	246	260	274	289	303	317	331	345
17	72	156	173	189	206	223	239	256	273	289	306	322	339	356	372	389	406
17	84	179	199	218	237	256	275	294	313	332	351	370	390	409	428	447	466
17	96	203	224	246	267	289	311	332	354	375	397	419	440	462	483	505	526
17	102	214	237	260	283	306	328	351	374	397	420	443	465	488	511	534	557
17	117	242	268	294	320	346	372	397	423	449	475	501	526	552	578	604	630
18	48	114	126	138	150	162	175	187	199	211	223	235	247	259	271	284	296
18	60	138	153	168	182	197	212	226	241	256	270	285	300	315	329	344	359
18	72	162	180	197	214	231	249	266	283	301	318	335	352	370	387	404	422
18	84	187	206	226	246	266	286	306	326	345	365	385	405	425	445	465	484
18	96	211	233	256	278	301	323	345	368	390	413	435	458	480	502	525	547
18	102	223	247	270	294	318	342	365	389	413	436	460	484	508	531	555	579
18	117	252	279	306	333	360	386	413	440	467	494	521	547	574	601	628	655
19	48	118	131	143	156	168	181	194	206	219	231	244	256	269	282	294	307
19	60	143	159	174	189	204	220	235	250	265	281	296	311	326	342	357	372
19	72	169	187	204	222	240	258	276	294	312	330	348	366	384	402	420	437
19	84	194	214	235	256	276	297	317	338	359	379	400	420	441	462	482	503
19	96	219	242	266	289	312	335	359	382	405	429	452	475	498	522	545	568
19	102	232	256	281	305	330	355	379	404	429	453	478	502	527	552	576	601
19	117	262	290	318	346	373	401	429	457	485	513	541	569	596	624	652	680
20	48	123	136	149	162	175	188	201	214	227	240	253	266	279	292	305	318
20	60	149	164	180	196	212	228	243	259	275	291	307	322	338	354	370	386
20	72	175	193	212	231	249	268	286	305	323	342	361	379	398	416	435	453
20	84	201	222	244	265	286	308	329	350	372	393	415	436	457	479	500	521
20	96	227	251	275	300	324	348	372	396	420	444	468	493	517	541	565	589
20	102	240	266	291	317	342	368	393	419	444	470	495	521	547	572	598	623
20	117	272	301	330	358	387	416	445	474	503	532	561	590	618	647	676	705
21	48	127	140	154	167	181	194	208	221	234	248	261	275	288	302	315	329
21	60	154	170	187	203	219	236	252	268	285	301	317	334	350	366	383	399
21	72	181	200	219	239	258	277	296	316	335	354	373	392	412	431	450	469
21	84	208	230	252	274	297	319	341	363	385	407	429	451	473	495	518	540
21	96	235	260	285	310	335	360	385	410	435	460	485	510	535	560	585	610
21	102	249	275	302	328	355	381	407	434	460	487	513	540	566	592	619	645
21	117	282	312	341	371	401	431	461	491	521	551	581	611	640	670	700	730
22	48	131	145	159	173	187	201	215	228	242	256	270	284	298	312	326	340
22	60	159	176	193	210	227	244	260	277	294	311	328	345	362	379	396	412
22	72	187	207	227	247	267	287	306	326	346	366	386	406	426	446	465	485
22	84	215	238	261	284	307	330	352	375	398	421	444	467	490	512	535	558
22	96	243	269	295	321	347	373	398	424	450	476	502	528	553	579	605	631
22	102	257	285	312	339	367	394	421	449	476	503	531	558	585	613	640	667
22	117	291	322	353	384	415	446	477	508	539	570	601	632	663	693	724	755
23	48	135	150	164	178	193	207	221	236	250	265	279	293	308	322	336	351
23	60	164	182	199	217	234	252	269	286	304	321	339	356	374	391	408	426
23	72	193	214	235	255	276	296	317	337	358	378	399	419	440	460	481	501
23	84	223	246	270	293	317	341	364	388	411	435	459	482	506	529	553	577
23	96	252	278	305	332	358	385	412	438	465	492	518	545	572	598	625	652
23	102	266	294	323	351	379	407	435	464	492	520	548	577	605	633	661	689
23	117	301	333	365	397	429	461	493	525	557	589	621	653	685	717	748	780
24	48	140	154	169	184	199	214	228	243	258	273	288	302	317	332	347	362
24	60	170	188	206	224	242	260	278	296	314	331	349	367	385	403	421	439
24	72	200	221	242	263	284	306	327	348	369	390	411	432	454	475	496	517
24	84	230	254	278	303	327	351	376	400	424	449	473	498	522	546	571	595
24	96	260	287	315	342	370	397	425	452	480	508	535	563	590	618	645	673
24	102	275	304	333	362	391	420	449	479	508	537	566	595	624	653	682	712
24	117	311	344	377	410	443	476	509	542	575	608	641	674	707	740	773	806
25	48	146	162	177	192	208	223	239	254	270	285	301	316	332	347	363	378
25	60	178	196	215	234	253	272	290	309	328	347	366	384	403	422	441	460
25	72	209	231	253	275	298	320	342	364	386	408	430	453	475	497	519	541
25	84	240	266	291	317	342	368	393	419	444	470	495	521	546	572	597	623
25	96	272	301	330	358	387	416	445	474	502	531	560	589	618	646	675	704
25	102	288	318	349	379	410	440	471	501	531	562	592	623	653	684	714	745
25	117	326	360	395	429	464	498	533	567	602	636	671	705	740	774	809	843
26	48	150	166	182	198	214	230	246	262	278	294	309	325	341	357	373	389
26	60	183	202	222	241	260	280	299	318	338	357	376	396	415	434	454	473
26	72	215	238	261	284	306	329	352	375	398	420	443	466	489	511	534	557
26	84	248	274	300	326	353	379	405	431	457	484	510	536	562	589	615	641
26	96	280	310	339	369	399	428	458	488	517	547	577	606	636	666	695	725
26	102	296	328	359	390	422	453	485	516	547	579	610	641	673	704	736	767
26	117	336	371	407	442	478	513	549	584	620	655	691	726	762	797	833	868

FABRIC SHADES: Roman — Lined* (Lining 01000)

Chart pricing includes board mount or headrail mount. Sizes and series numbers beyond what is listed in the charts below are available—please submit these quote requests via fax or email. **NOTE: For headrail mount:** manual—maximum width 112"; motorized—maximum width 77". For larger widths, please order board mount shades.

FLAT ROMAN SHADE

Series 07

Length Up To	Overall Finished Width							
	24	36	48	60	72	84	96	108
36	280	369	404	501	576	651	727	823
48	309	359	445	572	658	743	829	936
60	294	390	485	623	719	814	910	1,048
72	365	471	577	725	831	936	1,042	1,190
84	385	501	617	796	912	1,028	1,144	1,302
96	406	532	658	847	973	1,099	1,225	1,415
108	477	613	750	949	1,085	1,221	1,358	1,557

Series 08

Length Up To	Overall Finished Width							
	24	36	48	60	72	84	96	108
36	290	379	414	516	591	666	742	843
48	319	369	455	592	678	763	849	961
60	304	400	495	643	739	834	930	1,078
72	380	486	592	750	856	961	1,067	1,225
84	400	516	632	826	942	1,058	1,174	1,342
96	421	547	673	877	1,003	1,129	1,255	1,460
108	497	633	770	984	1,120	1,256	1,393	1,607

Series 09

Length Up To	Overall Finished Width							
	24	36	48	60	72	84	96	108
36	298	387	422	528	603	678	754	859
48	327	377	463	608	694	779	865	981
60	312	408	503	659	755	850	946	1,102
72	392	498	604	770	876	981	1,087	1,253
84	412	528	644	850	966	1,082	1,198	1,374
96	433	559	685	901	1,027	1,153	1,279	1,496
108	513	649	786	1,012	1,148	1,284	1,421	1,647

Series 10

Length Up To	Overall Finished Width							
	24	36	48	60	72	84	96	108
36	306	395	430	540	615	690	766	875
48	335	385	471	624	710	795	881	1,001
60	320	416	511	675	771	866	962	1,126
72	404	510	616	790	896	1,001	1,107	1,281
84	424	540	656	874	990	1,106	1,222	1,406
96	445	571	697	925	1,051	1,177	1,303	1,532
108	529	665	802	1,040	1,176	1,312	1,449	1,687

Series 11

Length Up To	Overall Finished Width							
	24	36	48	60	72	84	96	108
36	314	403	438	552	627	702	778	891
48	343	393	479	640	726	811	897	1,021
60	328	424	519	691	787	882	978	1,150
72	416	522	628	810	916	1,021	1,127	1,309
84	436	552	668	898	1,014	1,130	1,246	1,438
96	457	583	709	949	1,075	1,201	1,327	1,568
108	545	681	818	1,068	1,204	1,340	1,477	1,727

Series 12

Length Up To	Overall Finished Width							
	24	36	48	60	72	84	96	108
36	322	411	446	564	639	714	790	907
48	351	401	487	656	742	827	913	1,041
60	336	432	527	707	803	898	994	1,174
72	428	534	640	830	936	1,041	1,147	1,337
84	448	564	680	922	1,038	1,154	1,270	1,470
96	469	595	721	973	1,099	1,225	1,351	1,604
108	561	697	834	1,096	1,232	1,368	1,505	1,767

Series 13

Length Up To	Overall Finished Width							
	24	36	48	60	72	84	96	108
36	330	419	454	576	651	726	802	923
48	359	409	495	672	758	843	929	1,061
60	344	440	535	723	819	914	1,010	1,198
72	440	546	652	850	956	1,061	1,167	1,365
84	460	576	692	946	1,062	1,178	1,294	1,502
96	481	607	733	997	1,123	1,249	1,375	1,640
108	577	713	850	1,124	1,260	1,396	1,533	1,807

Series 14

Length Up To	Overall Finished Width							
	24	36	48	60	72	84	96	108
36	338	427	462	588	663	738	814	939
48	367	417	503	688	774	859	945	1,081
60	352	448	543	739	835	930	1,026	1,222
72	452	558	664	870	976	1,081	1,187	1,393
84	472	588	704	970	1,086	1,202	1,318	1,534
96	493	619	745	1,021	1,147	1,273	1,399	1,676
108	593	729	866	1,152	1,288	1,424	1,561	1,847

Series 15

Length Up To	Overall Finished Width							
	24	36	48	60	72	84	96	108
36	346	435	470	600	675	750	826	955
48	375	425	511	704	790	875	961	1,101
60	360	456	551	755	851	946	1,042	1,246
72	464	570	676	890	996	1,101	1,207	1,421
84	484	600	716	994	1,110	1,226	1,342	1,566
96	505	631	757	1,045	1,171	1,297	1,423	1,712
108	609	745	882	1,180	1,316	1,452	1,589	1,887

Series 16

Length Up To	Overall Finished Width							
	24	36	48	60	72	84	96	108
36	354	443	478	612	687	762	838	971
48	383	433	519	720	806	891	977	1,121
60	368	464	559	771	867	962	1,058	1,270
72	476	582	688	910	1,016	1,121	1,227	1,449
84	496	612	728	1,018	1,134	1,250	1,366	1,598
96	517	643	769	1,069	1,195	1,321	1,447	1,748
108	625	761	898	1,208	1,344	1,480	1,617	1,927

Series 17

Length Up To	Overall Finished Width							
	24	36	48	60	72	84	96	108
36	362	451	486	624	699	774	850	987
48	391	441	527	736	822	907	993	1,141
60	376	472	567	787	883	978	1,074	1,294
72	488	594	700	930	1,036	1,141	1,247	1,477
84	508	624	740	1,042	1,158	1,274	1,390	1,630
96	529	655	781	1,093	1,219	1,345	1,471	1,784
108	641	777	914	1,236	1,372	1,508	1,645	1,967

Series 18

Length Up To	Overall Finished Width							
	24	36	48	60	72	84	96	108
36	370	459	494	636	711	786	862	1,003
48	399	449	535	752	838	923	1,009	1,161
60	384	480	575	803	899	994	1,090	1,318
72	500	606	712	950	1,056	1,161	1,267	1,505
84	520	636	752	1,066	1,182	1,298	1,414	1,662
96	541	667	793	1,117	1,243	1,369	1,495	1,820
108	657	793	930	1,264	1,400	1,536	1,673	2,007

*All Décor 54 shades are recommended lined only.

FABRIC SHADES: Roman — Lined* (Lining 01000)

Chart pricing includes board mount or headrail mount. Sizes and series numbers beyond what is listed in the charts below are available—please submit these quote requests via fax or email. **NOTE: For headrail mount:** manual—maximum width 112"; motorized—maximum width 77". For larger widths, please order board mount shades.

FLAT ROMAN SHADE

		Series 19							
		Overall Finished Width							
Length	Up To	24	36	48	60	72	84	96	108
36	36	378	467	502	648	723	798	874	1,019
48	48	407	457	543	768	854	939	1,025	1,181
60	60	392	488	583	819	915	1,010	1,106	1,342
72	72	512	618	724	970	1,076	1,181	1,287	1,533
84	84	532	648	764	1,090	1,206	1,322	1,438	1,694
96	96	553	679	805	1,141	1,267	1,393	1,519	1,856
108	108	673	809	946	1,292	1,428	1,564	1,701	2,047

		Series 20							
		Overall Finished Width							
Length	Up To	24	36	48	60	72	84	96	108
36	36	386	475	510	660	735	810	886	1,035
48	48	415	465	551	784	870	955	1,041	1,201
60	60	400	496	591	835	931	1,026	1,122	1,366
72	72	524	630	736	990	1,096	1,201	1,307	1,561
84	84	544	660	776	1,114	1,230	1,346	1,462	1,726
96	96	565	691	817	1,165	1,291	1,417	1,543	1,892
108	108	689	825	962	1,320	1,456	1,592	1,729	2,087

		Series 21							
		Overall Finished Width							
Length	Up To	24	36	48	60	72	84	96	108
36	36	394	483	518	672	747	822	898	1,051
48	48	423	473	559	800	886	971	1,057	1,221
60	60	408	504	599	851	947	1,042	1,138	1,390
72	72	536	642	748	1,010	1,116	1,221	1,327	1,589
84	84	556	672	788	1,138	1,254	1,370	1,486	1,758
96	96	577	703	829	1,189	1,315	1,441	1,567	1,928
108	108	705	841	978	1,348	1,484	1,620	1,757	2,127

		Series 22							
		Overall Finished Width							
Length	Up To	24	36	48	60	72	84	96	108
36	36	402	491	526	684	759	834	910	1,067
48	48	431	481	567	816	902	987	1,073	1,241
60	60	416	512	607	867	963	1,058	1,154	1,414
72	72	548	654	760	1,030	1,136	1,241	1,347	1,617
84	84	568	684	800	1,162	1,278	1,394	1,510	1,790
96	96	589	715	841	1,213	1,339	1,465	1,591	1,964
108	108	721	857	994	1,376	1,512	1,648	1,785	2,167

		Series 23							
		Overall Finished Width							
Length	Up To	24	36	48	60	72	84	96	108
36	36	410	499	534	696	771	846	922	1,083
48	48	439	489	575	832	918	1,003	1,089	1,261
60	60	424	520	615	883	979	1,074	1,170	1,438
72	72	560	666	772	1,050	1,156	1,261	1,367	1,645
84	84	580	696	812	1,186	1,302	1,418	1,534	1,822
96	96	601	727	853	1,237	1,363	1,489	1,615	2,000
108	108	737	873	1,010	1,404	1,540	1,676	1,813	2,207

		Series 24							
		Overall Finished Width							
Length	Up To	24	36	48	60	72	84	96	108
36	36	418	507	542	708	783	858	934	1,099
48	48	447	497	583	848	934	1,019	1,105	1,281
60	60	432	528	623	899	995	1,090	1,186	1,462
72	72	572	678	784	1,070	1,176	1,281	1,387	1,673
84	84	592	708	824	1,210	1,326	1,442	1,558	1,854
96	96	613	739	865	1,261	1,387	1,513	1,639	2,036
108	108	753	889	1,026	1,432	1,568	1,704	1,841	2,247

		Series 25							
		Overall Finished Width							
Length	Up To	24	36	48	60	72	84	96	108
36	36	430	519	554	726	801	876	952	1,123
48	48	459	509	595	872	958	1,043	1,129	1,311
60	60	444	540	635	923	1,019	1,114	1,210	1,498
72	72	590	696	802	1,100	1,206	1,311	1,417	1,715
84	84	610	726	842	1,246	1,362	1,478	1,594	1,902
96	96	631	757	883	1,297	1,423	1,549	1,675	2,090
108	108	777	913	1,050	1,474	1,610	1,746	1,883	2,307

		Series 26							
		Overall Finished Width							
Length	Up To	24	36	48	60	72	84	96	108
36	36	438	527	562	738	813	888	964	1,139
48	48	467	517	603	888	974	1,059	1,145	1,331
60	60	452	548	643	939	1,035	1,130	1,226	1,522
72	72	602	708	814	1,120	1,226	1,331	1,437	1,743
84	84	622	738	854	1,270	1,386	1,502	1,618	1,934
96	96	643	769	895	1,321	1,447	1,573	1,699	2,126
108	108	793	929	1,066	1,502	1,638	1,774	1,911	2,347

		Series 27							
		Overall Finished Width							
Length	Up To	24	36	48	60	72	84	96	108
36	36	446	535	570	750	825	900	976	1,155
48	48	475	525	611	904	990	1,075	1,161	1,351
60	60	460	556	651	955	1,051	1,146	1,242	1,546
72	72	614	720	826	1,140	1,246	1,351	1,457	1,771
84	84	634	750	866	1,294	1,410	1,526	1,642	1,966
96	96	655	781	907	1,345	1,471	1,597	1,723	2,162
108	108	809	945	1,082	1,530	1,666	1,802	1,939	2,387

		Series 28							
		Overall Finished Width							
Length	Up To	24	36	48	60	72	84	96	108
36	36	454	543	578	762	837	912	988	1,171
48	48	483	533	619	920	1,006	1,091	1,177	1,371
60	60	468	564	659	971	1,067	1,162	1,258	1,570
72	72	626	732	838	1,160	1,266	1,371	1,477	1,799
84	84	646	762	878	1,318	1,434	1,550	1,666	1,998
96	96	667	793	919	1,369	1,495	1,621	1,747	2,198
108	108	825	961	1,098	1,558	1,694	1,830	1,967	2,427

		Series 29							
		Overall Finished Width							
Length	Up To	24	36	48	60	72	84	96	108
36	36	462	551	586	774	849	924	1,000	1,187
48	48	491	541	627	936	1,022	1,107	1,193	1,391
60	60	476	572	667	987	1,083	1,178	1,274	1,594
72	72	638	744	850	1,180	1,286	1,391	1,497	1,827
84	84	658	774	890	1,342	1,458	1,574	1,690	2,030
96	96	679	805	931	1,393	1,519	1,645	1,771	2,234
108	108	841	977	1,114	1,586	1,722	1,858	1,995	2,467

		Series 30							
		Overall Finished Width							
Length	Up To	24	36	48	60	72	84	96	108
36	36	474	563	598	792	867	942	1,018	1,211
48	48	503	553	639	960	1,046	1,131	1,217	1,421
60	60	488	584	679	1,011	1,107	1,202	1,298	1,630
72	72	656	762	868	1,210	1,316	1,421	1,527	1,869
84	84	676	792	908	1,378	1,494	1,610	1,726	2,078
96	96	697	823	949	1,429	1,555	1,681	1,807	2,288
108	108	865	1,001	1,138	1,628	1,764	1,900	2,037	2,527

*All Décor 54 shades are recommended lined only.

FABRIC SHADES: Roman — Lined* (Lining 01000)

Chart pricing includes board mount or headrail mount. Sizes and series numbers beyond what is listed in the charts below are available—please submit these quote requests via fax or email. **NOTE: For headrail mount:** manual—maximum width 95"; motorized—maximum width 67". For larger widths, please order board mount shades.

FRONT SLAT & BACK SLAT ROMAN SHADE

		Series 07							
		Overall Finished Width							
Length	Up To	24	36	48	60	72	84	96	108
	36	284	375	413	511	589	667	744	864
	48	315	368	456	587	675	764	852	982
	60	352	451	551	692	791	891	990	1,131
	72	374	484	594	767	877	988	1,098	1,250
	84	447	568	689	873	994	1,115	1,236	1,420
	96	468	600	732	927	1,059	1,191	1,323	1,538
	108	490	633	775	1,002	1,145	1,288	1,430	1,657

		Series 08							
		Overall Finished Width							
Length	Up To	24	36	48	60	72	84	96	108
	36	294	385	423	526	604	682	759	889
	48	325	378	466	607	695	784	872	1,012
	60	367	466	566	717	816	916	1,015	1,166
	72	389	499	609	797	907	1,018	1,128	1,290
	84	467	588	709	908	1,029	1,150	1,271	1,470
	96	488	620	752	962	1,094	1,226	1,358	1,593
	108	510	653	795	1,042	1,185	1,328	1,470	1,717

		Series 09							
		Overall Finished Width							
Length	Up To	24	36	48	60	72	84	96	108
	36	302	393	431	538	616	694	771	909
	48	333	386	474	623	711	800	888	1,036
	60	379	478	578	737	836	936	1,035	1,194
	72	401	511	621	821	931	1,042	1,152	1,322
	84	483	604	725	936	1,057	1,178	1,299	1,510
	96	504	636	768	990	1,122	1,254	1,386	1,637
	108	526	669	811	1,074	1,217	1,360	1,502	1,765

		Series 10							
		Overall Finished Width							
Length	Up To	24	36	48	60	72	84	96	108
	36	310	401	439	550	628	706	783	929
	48	341	394	482	639	727	816	904	1,060
	60	391	490	590	757	856	956	1,055	1,222
	72	413	523	633	845	955	1,066	1,176	1,354
	84	499	620	741	964	1,085	1,206	1,327	1,550
	96	520	652	784	1,018	1,150	1,282	1,414	1,681
	108	542	685	827	1,106	1,249	1,392	1,534	1,813

		Series 11							
		Overall Finished Width							
Length	Up To	24	36	48	60	72	84	96	108
	36	318	409	447	562	640	718	795	949
	48	349	402	490	655	743	832	920	1,084
	60	403	502	602	777	876	976	1,075	1,250
	72	425	535	645	869	979	1,090	1,200	1,386
	84	515	636	757	992	1,113	1,234	1,355	1,590
	96	536	668	800	1,046	1,178	1,310	1,442	1,725
	108	558	701	843	1,138	1,281	1,424	1,566	1,861

		Series 12							
		Overall Finished Width							
Length	Up To	24	36	48	60	72	84	96	108
	36	326	417	455	574	652	730	807	969
	48	357	410	498	671	759	848	936	1,108
	60	415	514	614	797	896	996	1,095	1,278
	72	437	547	657	893	1,003	1,114	1,224	1,418
	84	531	652	773	1,020	1,141	1,262	1,383	1,630
	96	552	684	816	1,074	1,206	1,338	1,470	1,769
	108	574	717	859	1,170	1,313	1,456	1,598	1,909

		Series 13							
		Overall Finished Width							
Length	Up To	24	36	48	60	72	84	96	108
	36	334	425	463	586	664	742	819	989
	48	365	418	506	687	775	864	952	1,132
	60	427	526	626	817	916	1,016	1,115	1,306
	72	449	559	669	917	1,027	1,138	1,248	1,450
	84	547	668	789	1,048	1,169	1,290	1,411	1,670
	96	568	700	832	1,102	1,234	1,366	1,498	1,813
	108	590	733	875	1,202	1,345	1,488	1,630	1,957

		Series 14							
		Overall Finished Width							
Length	Up To	24	36	48	60	72	84	96	108
	36	342	433	471	598	676	754	831	1,009
	48	373	426	514	703	791	880	968	1,156
	60	439	538	638	837	936	1,036	1,135	1,334
	72	461	571	681	941	1,051	1,162	1,272	1,482
	84	563	684	805	1,076	1,197	1,318	1,439	1,710
	96	584	716	848	1,130	1,262	1,394	1,526	1,857
	108	606	749	891	1,234	1,377	1,520	1,662	2,005

		Series 15							
		Overall Finished Width							
Length	Up To	24	36	48	60	72	84	96	108
	36	350	441	479	610	688	766	843	1,029
	48	381	434	522	719	807	896	984	1,180
	60	451	550	650	857	956	1,056	1,155	1,362
	72	473	583	693	965	1,075	1,186	1,296	1,514
	84	579	700	821	1,104	1,225	1,346	1,467	1,750
	96	600	732	864	1,158	1,290	1,422	1,554	1,901
	108	622	765	907	1,266	1,409	1,552	1,694	2,053

		Series 16							
		Overall Finished Width							
Length	Up To	24	36	48	60	72	84	96	108
	36	358	449	487	622	700	778	855	1,049
	48	389	442	530	735	823	912	1,000	1,204
	60	463	562	662	877	976	1,076	1,175	1,390
	72	485	595	705	989	1,099	1,210	1,320	1,546
	84	595	716	837	1,132	1,253	1,374	1,495	1,790
	96	616	748	880	1,186	1,318	1,450	1,582	1,945
	108	638	781	923	1,298	1,441	1,584	1,726	2,101

		Series 17							
		Overall Finished Width							
Length	Up To	24	36	48	60	72	84	96	108
	36	366	457	495	634	712	790	867	1,069
	48	397	450	538	751	839	928	1,016	1,228
	60	475	574	674	897	996	1,096	1,195	1,418
	72	497	607	717	1,013	1,123	1,234	1,344	1,578
	84	611	732	853	1,160	1,281	1,402	1,523	1,830
	96	632	764	896	1,214	1,346	1,478	1,610	1,989
	108	654	797	939	1,330	1,473	1,616	1,758	2,149

		Series 18							
		Overall Finished Width							
Length	Up To	24	36	48	60	72	84	96	108
	36	374	465	503	646	724	802	879	1,089
	48	405	458	546	767	855	944	1,032	1,252
	60	487	586	686	917	1,016	1,116	1,215	1,446
	72	509	619	729	1,037	1,147	1,258	1,368	1,610
	84	627	748	869	1,188	1,309	1,430	1,551	1,870
	96	648	780	912	1,242	1,374	1,506	1,638	2,033
	108	670	813	955	1,362	1,505	1,648	1,790	2,197

*All Décor 54 shades are recommended lined only.

FABRIC SHADES: Roman — Lined* (Lining 01000)

Chart pricing includes board mount or headrail mount. Sizes and series numbers beyond what is listed in the charts below are available—please submit these quote requests via fax or email. **NOTE: For headrail mount:** manual—maximum width 95"; motorized—maximum width 67". For larger widths, please order board mount shades.

FRONT SLAT & BACK SLAT ROMAN SHADE

		Series 19							
		Overall Finished Width							
Length	Up To	24	36	48	60	72	84	96	108
36	36	382	473	511	658	736	814	891	1,109
48	48	413	466	554	783	871	960	1,048	1,276
60	60	499	598	698	937	1,036	1,136	1,235	1,474
72	72	521	631	741	1,061	1,171	1,282	1,392	1,642
84	84	643	764	885	1,216	1,337	1,458	1,579	1,910
96	96	664	796	928	1,270	1,402	1,534	1,666	2,077
108	108	686	829	971	1,394	1,537	1,680	1,822	2,245

		Series 20							
		Overall Finished Width							
Length	Up To	24	36	48	60	72	84	96	108
36	36	390	481	519	670	748	826	903	1,129
48	48	421	474	562	799	887	976	1,064	1,300
60	60	511	610	710	957	1,056	1,156	1,255	1,502
72	72	533	643	753	1,085	1,195	1,306	1,416	1,674
84	84	659	780	901	1,244	1,365	1,486	1,607	1,950
96	96	680	812	944	1,298	1,430	1,562	1,694	2,121
108	108	702	845	987	1,426	1,569	1,712	1,854	2,293

		Series 21							
		Overall Finished Width							
Length	Up To	24	36	48	60	72	84	96	108
36	36	398	489	527	682	760	838	915	1,149
48	48	429	482	570	815	903	992	1,080	1,324
60	60	523	622	722	977	1,076	1,176	1,275	1,530
72	72	545	655	765	1,109	1,219	1,330	1,440	1,706
84	84	675	796	917	1,272	1,393	1,514	1,635	1,990
96	96	696	828	960	1,326	1,458	1,590	1,722	2,165
108	108	718	861	1,003	1,458	1,601	1,744	1,886	2,341

		Series 22							
		Overall Finished Width							
Length	Up To	24	36	48	60	72	84	96	108
36	36	406	497	535	694	772	850	927	1,169
48	48	437	490	578	831	919	1,008	1,096	1,348
60	60	535	634	734	997	1,096	1,196	1,295	1,558
72	72	557	667	777	1,133	1,243	1,354	1,464	1,738
84	84	691	812	933	1,300	1,421	1,542	1,663	2,030
96	96	712	844	976	1,354	1,486	1,618	1,750	2,209
108	108	734	877	1,019	1,490	1,633	1,776	1,918	2,389

		Series 23							
		Overall Finished Width							
Length	Up To	24	36	48	60	72	84	96	108
36	36	414	505	543	706	784	862	939	1,189
48	48	445	498	586	847	935	1,024	1,112	1,372
60	60	547	646	746	1,017	1,116	1,216	1,315	1,586
72	72	569	679	789	1,157	1,267	1,378	1,488	1,770
84	84	707	828	949	1,328	1,449	1,570	1,691	2,070
96	96	728	860	992	1,382	1,514	1,646	1,778	2,253
108	108	750	893	1,035	1,522	1,665	1,808	1,950	2,437

		Series 24							
		Overall Finished Width							
Length	Up To	24	36	48	60	72	84	96	108
36	36	422	513	551	718	796	874	951	1,209
48	48	453	506	594	863	951	1,040	1,128	1,396
60	60	559	658	758	1,037	1,136	1,236	1,335	1,614
72	72	581	691	801	1,181	1,291	1,402	1,512	1,802
84	84	723	844	965	1,356	1,477	1,598	1,719	2,110
96	96	744	876	1,008	1,410	1,542	1,674	1,806	2,297
108	108	766	909	1,051	1,554	1,697	1,840	1,982	2,485

		Series 25							
		Overall Finished Width							
Length	Up To	24	36	48	60	72	84	96	108
36	36	434	525	563	736	814	892	969	1,239
48	48	465	518	606	887	975	1,064	1,152	1,432
60	60	577	676	776	1,067	1,166	1,266	1,365	1,656
72	72	599	709	819	1,217	1,327	1,438	1,548	1,850
84	84	747	868	989	1,398	1,519	1,640	1,761	2,170
96	96	768	900	1,032	1,452	1,584	1,716	1,848	2,363
108	108	790	933	1,075	1,602	1,745	1,888	2,030	2,557

		Series 26							
		Overall Finished Width							
Length	Up To	24	36	48	60	72	84	96	108
36	36	442	533	571	748	826	904	981	1,259
48	48	473	526	614	903	991	1,080	1,168	1,456
60	60	589	688	788	1,087	1,186	1,286	1,385	1,684
72	72	611	721	831	1,241	1,351	1,462	1,572	1,882
84	84	763	884	1,005	1,426	1,547	1,668	1,789	2,210
96	96	784	916	1,048	1,480	1,612	1,744	1,876	2,407
108	108	806	949	1,091	1,634	1,777	1,920	2,062	2,605

		Series 27							
		Overall Finished Width							
Length	Up To	24	36	48	60	72	84	96	108
36	36	450	541	579	760	838	916	993	1,279
48	48	481	534	622	919	1,007	1,096	1,184	1,480
60	60	601	700	800	1,107	1,206	1,306	1,405	1,712
72	72	623	733	843	1,265	1,375	1,486	1,596	1,914
84	84	779	900	1,021	1,454	1,575	1,696	1,817	2,250
96	96	800	932	1,064	1,508	1,640	1,772	1,904	2,451
108	108	822	965	1,107	1,666	1,809	1,952	2,094	2,653

		Series 28							
		Overall Finished Width							
Length	Up To	24	36	48	60	72	84	96	108
36	36	458	549	587	772	850	928	1,005	1,299
48	48	489	542	630	935	1,023	1,112	1,200	1,504
60	60	613	712	812	1,127	1,226	1,326	1,425	1,740
72	72	635	745	855	1,289	1,399	1,510	1,620	1,946
84	84	795	916	1,037	1,482	1,603	1,724	1,845	2,290
96	96	816	948	1,080	1,536	1,668	1,800	1,932	2,495
108	108	838	981	1,123	1,698	1,841	1,984	2,126	2,701

		Series 29							
		Overall Finished Width							
Length	Up To	24	36	48	60	72	84	96	108
36	36	466	557	595	784	862	940	1,017	1,319
48	48	497	550	638	951	1,039	1,128	1,216	1,528
60	60	625	724	824	1,147	1,246	1,346	1,445	1,768
72	72	647	757	867	1,313	1,423	1,534	1,644	1,978
84	84	811	932	1,053	1,510	1,631	1,752	1,873	2,330
96	96	832	964	1,096	1,564	1,696	1,828	1,960	2,539
108	108	854	997	1,139	1,730	1,873	2,016	2,158	2,749

		Series 30							
		Overall Finished Width							
Length	Up To	24	36	48	60	72	84	96	108
36	36	478	569	607	802	880	958	1,035	1,349
48	48	509	562	650	975	1,063	1,152	1,240	1,564
60	60	643	742	842	1,177	1,276	1,376	1,475	1,810
72	72	665	775	885	1,349	1,459	1,570	1,680	2,026
84	84	835	956	1,077	1,552	1,673	1,794	1,915	2,390
96	96	856	988	1,120	1,606	1,738	1,870	2,002	2,605
108	108	878	1,021	1,163	1,778	1,921	2,064	2,206	2,821

*All Décor 54 shades are recommended lined only.

FABRIC SHADES: Roman — Lined* (Lining 01000)

Chart pricing includes board mount or headrail mount. Sizes and series numbers beyond what is listed in the charts below are available—please submit these quote requests via fax or email. **NOTE: For headrail mount:** manual—maximum width 66"; motorized—maximum width 44". For larger widths, please order board mount shades.

HOBBLED (5" SPACING) & WATERFALL (7" SPACING) ROMAN SHADE

		Series 07							
		Overall Finished Width							
Length	Up To	24	36	48	60	72	84	96	108
36	36	343	438	517	597	677	757	838	981
48	48	487	541	696	788	880	972	1,064	1,219
60	60	502	606	794	897	1,001	1,105	1,209	1,397
72	72	577	692	913	1,028	1,144	1,259	1,375	1,596
84	84	651	778	1,011	1,138	1,265	1,393	1,520	1,773
96	96	756	895	1,160	1,299	1,438	1,577	1,716	1,981
108	108	809	960	1,258	1,409	1,560	1,710	1,861	2,159

		Series 08							
		Overall Finished Width							
Length	Up To	24	36	48	60	72	84	96	108
36	36	358	453	542	622	702	782	863	1,021
48	48	507	561	731	823	915	1,007	1,099	1,269
60	60	552	656	864	967	1,071	1,175	1,279	1,487
72	72	632	747	993	1,108	1,224	1,339	1,455	1,701
84	84	711	838	1,096	1,223	1,350	1,478	1,605	1,888
96	96	791	930	1,225	1,364	1,503	1,642	1,781	2,076
108	108	844	995	1,328	1,479	1,630	1,780	1,931	2,264

		Series 09							
		Overall Finished Width							
Length	Up To	24	36	48	60	72	84	96	108
36	36	370	465	562	642	722	802	883	1,053
48	48	523	577	759	851	943	1,035	1,127	1,309
60	60	568	672	896	999	1,103	1,207	1,311	1,535
72	72	652	767	1,033	1,148	1,264	1,379	1,495	1,761
84	84	735	862	1,140	1,267	1,394	1,522	1,649	1,956
96	96	819	958	1,277	1,416	1,555	1,694	1,833	2,152
108	108	872	1,023	1,384	1,535	1,686	1,836	1,987	2,348

		Series 10							
		Overall Finished Width							
Length	Up To	24	36	48	60	72	84	96	108
36	36	382	477	582	662	742	822	903	1,085
48	48	539	593	787	879	971	1,063	1,155	1,349
60	60	584	688	928	1,031	1,135	1,239	1,343	1,583
72	72	672	787	1,073	1,188	1,304	1,419	1,535	1,821
84	84	759	886	1,184	1,311	1,438	1,566	1,693	2,024
96	96	847	986	1,329	1,468	1,607	1,746	1,885	2,228
108	108	930	1,081	1,470	1,621	1,772	1,922	2,073	2,462

		Series 11							
		Overall Finished Width							
Length	Up To	24	36	48	60	72	84	96	108
36	36	394	489	602	682	762	842	923	1,117
48	48	555	609	815	907	999	1,091	1,183	1,389
60	60	600	704	960	1,063	1,167	1,271	1,375	1,631
72	72	692	807	1,113	1,228	1,344	1,459	1,575	1,881
84	84	783	910	1,228	1,355	1,482	1,610	1,737	2,092
96	96	875	1,014	1,381	1,520	1,659	1,798	1,937	2,304
108	108	958	1,109	1,526	1,677	1,828	1,978	2,129	2,546

		Series 12							
		Overall Finished Width							
Length	Up To	24	36	48	60	72	84	96	108
36	36	406	501	622	702	782	862	943	1,149
48	48	571	625	843	935	1,027	1,119	1,211	1,429
60	60	616	720	992	1,095	1,199	1,303	1,407	1,679
72	72	712	827	1,153	1,268	1,384	1,499	1,615	1,941
84	84	807	934	1,272	1,399	1,526	1,654	1,781	2,160
96	96	933	1,072	1,463	1,602	1,741	1,880	2,019	2,410
108	108	986	1,137	1,582	1,733	1,884	2,034	2,185	2,630

		Series 13							
		Overall Finished Width							
Length	Up To	24	36	48	60	72	84	96	108
36	36	418	513	642	722	802	882	963	1,181
48	48	587	641	871	963	1,055	1,147	1,239	1,469
60	60	632	736	1,024	1,127	1,231	1,335	1,439	1,727
72	72	732	847	1,193	1,308	1,424	1,539	1,655	2,001
84	84	831	958	1,316	1,443	1,570	1,698	1,825	2,228
96	96	961	1,100	1,515	1,654	1,793	1,932	2,071	2,486
108	108	1,014	1,165	1,638	1,789	1,940	2,090	2,241	2,714

		Series 14							
		Overall Finished Width							
Length	Up To	24	36	48	60	72	84	96	108
36	36	430	525	662	742	822	902	983	1,213
48	48	603	657	899	991	1,083	1,175	1,267	1,509
60	60	648	752	1,056	1,159	1,263	1,367	1,471	1,775
72	72	752	867	1,233	1,348	1,464	1,579	1,695	2,061
84	84	885	1,012	1,390	1,517	1,644	1,772	1,899	2,326
96	96	989	1,128	1,567	1,706	1,845	1,984	2,123	2,562
108	108	1,072	1,223	1,724	1,875	2,026	2,176	2,327	2,828

		Series 15							
		Overall Finished Width							
Length	Up To	24	36	48	60	72	84	96	108
36	36	442	537	682	762	842	922	1,003	1,245
48	48	619	673	927	1,019	1,111	1,203	1,295	1,549
60	60	664	768	1,088	1,191	1,295	1,399	1,503	1,823
72	72	772	887	1,273	1,388	1,504	1,619	1,735	2,121
84	84	909	1,036	1,434	1,561	1,688	1,816	1,943	2,394
96	96	1,017	1,156	1,619	1,758	1,897	2,036	2,175	2,638
108	108	1,100	1,251	1,780	1,931	2,082	2,232	2,383	2,912

		Series 16							
		Overall Finished Width							
Length	Up To	24	36	48	60	72	84	96	108
36	36	454	549	702	782	862	942	1,023	1,277
48	48	665	719	985	1,077	1,169	1,261	1,353	1,619
60	60	710	814	1,150	1,253	1,357	1,461	1,565	1,901
72	72	822	937	1,343	1,458	1,574	1,689	1,805	2,211
84	84	933	1,060	1,478	1,605	1,732	1,860	1,987	2,462
96	96	1,075	1,214	1,701	1,840	1,979	2,118	2,257	2,744
108	108	1,128	1,279	1,836	1,987	2,138	2,288	2,439	2,996

		Series 17							
		Overall Finished Width							
Length	Up To	24	36	48	60	72	84	96	108
36	36	466	561	722	802	882	962	1,043	1,309
48	48	681	735	1,013	1,105	1,197	1,289	1,381	1,659
60	60	726	830	1,182	1,285	1,389	1,493	1,597	1,949
72	72	842	957	1,383	1,498	1,614	1,729	1,845	2,271
84	84	957	1,084	1,522	1,649	1,776	1,904	2,031	2,530
96	96	1,103	1,242	1,753	1,892	2,031	2,170	2,309	2,820
108	108	1,156	1,307	1,892	2,043	2,194	2,344	2,495	3,080

		Series 18							
		Overall Finished Width							
Length	Up To	24	36	48	60	72	84	96	108
36	36	478	573	742	822	902	982	1,063	1,341
48	48	697	751	1,041	1,133	1,225	1,317	1,409	1,699
60	60	742	846	1,214	1,317	1,421	1,525	1,629	1,997
72	72	862	977	1,423	1,538	1,654	1,769	1,885	2,331
84	84	981	1,108	1,566	1,693	1,820	1,948	2,075	2,598
96	96	1,131	1,270	1,805	1,944	2,083	2,222	2,361	2,896
108	108	1,214	1,365	1,978	2,129	2,280	2,430	2,581	3,194

*All Décor 54 shades are recommended lined only.

FABRIC SHADES: Roman — Lined* (Lining 01000)

Chart pricing includes board mount or headrail mount. Sizes and series numbers beyond what is listed in the charts below are available—please submit these quote requests via fax or email. **NOTE: For headrail mount:** manual—maximum width 66"; motorized—maximum width 44". For larger widths, please order board mount shades.

HOBBLED (5" SPACING) & WATERFALL (7" SPACING) ROMAN SHADE

		Series 19							
		Overall Finished Width							
Length	Up To	24	36	48	60	72	84	96	108
36	36	490	585	762	842	922	1,002	1,083	1,373
48	48	713	767	1,069	1,161	1,253	1,345	1,437	1,739
60	60	758	862	1,246	1,349	1,453	1,557	1,661	2,045
72	72	882	997	1,463	1,578	1,694	1,809	1,925	2,391
84	84	1,035	1,162	1,640	1,767	1,894	2,022	2,149	2,696
96	96	1,159	1,298	1,857	1,996	2,135	2,274	2,413	2,972
108	108	1,242	1,393	2,034	2,185	2,336	2,486	2,637	3,278

		Series 20							
		Overall Finished Width							
Length	Up To	24	36	48	60	72	84	96	108
36	36	502	597	782	862	942	1,022	1,103	1,405
48	48	729	783	1,097	1,189	1,281	1,373	1,465	1,779
60	60	774	878	1,278	1,381	1,485	1,589	1,693	2,093
72	72	902	1,017	1,503	1,618	1,734	1,849	1,965	2,451
84	84	1,059	1,186	1,684	1,811	1,938	2,066	2,193	2,764
96	96	1,187	1,326	1,909	2,048	2,187	2,326	2,465	3,048
108	108	1,270	1,421	2,090	2,241	2,392	2,542	2,693	3,362

		Series 21							
		Overall Finished Width							
Length	Up To	24	36	48	60	72	84	96	108
36	36	514	609	802	882	962	1,042	1,123	1,437
48	48	745	799	1,125	1,217	1,309	1,401	1,493	1,819
60	60	790	894	1,310	1,413	1,517	1,621	1,725	2,141
72	72	922	1,037	1,543	1,658	1,774	1,889	2,005	2,511
84	84	1,083	1,210	1,728	1,855	1,982	2,110	2,237	2,832
96	96	1,245	1,384	1,991	2,130	2,269	2,408	2,547	3,154
108	108	1,298	1,449	2,146	2,297	2,448	2,598	2,749	3,446

		Series 22							
		Overall Finished Width							
Length	Up To	24	36	48	60	72	84	96	108
36	36	526	621	822	902	982	1,062	1,143	1,469
48	48	761	815	1,153	1,245	1,337	1,429	1,521	1,859
60	60	806	910	1,342	1,445	1,549	1,653	1,757	2,189
72	72	942	1,057	1,583	1,698	1,814	1,929	2,045	2,571
84	84	1,107	1,234	1,772	1,899	2,026	2,154	2,281	2,900
96	96	1,273	1,412	2,043	2,182	2,321	2,460	2,599	3,230
108	108	1,356	1,507	2,232	2,383	2,534	2,684	2,835	3,560

		Series 23							
		Overall Finished Width							
Length	Up To	24	36	48	60	72	84	96	108
36	36	538	633	842	922	1,002	1,082	1,163	1,501
48	48	777	831	1,181	1,273	1,365	1,457	1,549	1,899
60	60	822	926	1,374	1,477	1,581	1,685	1,789	2,237
72	72	962	1,077	1,623	1,738	1,854	1,969	2,085	2,631
84	84	1,131	1,258	1,816	1,943	2,070	2,198	2,325	2,968
96	96	1,301	1,440	2,095	2,234	2,373	2,512	2,651	3,306
108	108	1,384	1,535	2,288	2,439	2,590	2,740	2,891	3,644

		Series 24							
		Overall Finished Width							
Length	Up To	24	36	48	60	72	84	96	108
36	36	550	645	862	942	1,022	1,102	1,183	1,533
48	48	793	847	1,209	1,301	1,393	1,485	1,577	1,939
60	60	868	972	1,436	1,539	1,643	1,747	1,851	2,315
72	72	1,012	1,127	1,693	1,808	1,924	2,039	2,155	2,721
84	84	1,155	1,282	1,860	1,987	2,114	2,242	2,369	3,036
96	96	1,329	1,468	2,147	2,286	2,425	2,564	2,703	3,382
108	108	1,412	1,563	2,344	2,495	2,646	2,796	2,947	3,728

		Series 25							
		Overall Finished Width							
Length	Up To	24	36	48	60	72	84	96	108
36	36	568	663	892	972	1,052	1,132	1,213	1,581
48	48	817	871	1,251	1,343	1,435	1,527	1,619	1,999
60	60	892	996	1,484	1,587	1,691	1,795	1,899	2,387
72	72	1,042	1,157	1,753	1,868	1,984	2,099	2,215	2,811
84	84	1,221	1,348	1,956	2,083	2,210	2,338	2,465	3,168
96	96	1,401	1,540	2,255	2,394	2,533	2,672	2,811	3,526
108	108	1,454	1,605	2,428	2,579	2,730	2,880	3,031	3,854

		Series 26							
		Overall Finished Width							
Length	Up To	24	36	48	60	72	84	96	108
36	36	580	675	912	992	1,072	1,152	1,233	1,613
48	48	833	887	1,279	1,371	1,463	1,555	1,647	2,039
60	60	908	1,012	1,516	1,619	1,723	1,827	1,931	2,435
72	72	1,062	1,177	1,793	1,908	2,024	2,139	2,255	2,871
84	84	1,245	1,372	2,000	2,127	2,254	2,382	2,509	3,236
96	96	1,429	1,568	2,307	2,446	2,585	2,724	2,863	3,602
108	108	1,512	1,663	2,514	2,665	2,816	2,966	3,117	3,968

		Series 27							
		Overall Finished Width							
Length	Up To	24	36	48	60	72	84	96	108
36	36	592	687	932	1,012	1,092	1,172	1,253	1,645
48	48	849	903	1,307	1,399	1,491	1,583	1,675	2,079
60	60	924	1,028	1,548	1,651	1,755	1,859	1,963	2,483
72	72	1,082	1,197	1,833	1,948	2,064	2,179	2,295	2,931
84	84	1,269	1,396	2,044	2,171	2,298	2,426	2,553	3,304
96	96	1,457	1,596	2,359	2,498	2,637	2,776	2,915	3,678
108	108	1,540	1,691	2,570	2,721	2,872	3,022	3,173	4,052

		Series 28							
		Overall Finished Width							
Length	Up To	24	36	48	60	72	84	96	108
36	36	604	699	952	1,032	1,112	1,192	1,273	1,677
48	48	895	949	1,365	1,457	1,549	1,641	1,733	2,149
60	60	940	1,044	1,580	1,683	1,787	1,891	1,995	2,531
72	72	1,102	1,217	1,873	1,988	2,104	2,219	2,335	2,991
84	84	1,293	1,420	2,088	2,215	2,342	2,470	2,597	3,372
96	96	1,485	1,624	2,411	2,550	2,689	2,828	2,967	3,754
108	108	1,568	1,719	2,626	2,777	2,928	3,078	3,229	4,136

		Series 29							
		Overall Finished Width							
Length	Up To	24	36	48	60	72	84	96	108
36	36	616	711	972	1,052	1,132	1,212	1,293	1,709
48	48	911	965	1,393	1,485	1,577	1,669	1,761	2,189
60	60	956	1,060	1,612	1,715	1,819	1,923	2,027	2,579
72	72	1,122	1,237	1,913	2,028	2,144	2,259	2,375	3,051
84	84	1,317	1,444	2,132	2,259	2,386	2,514	2,641	3,440
96	96	1,513	1,652	2,463	2,602	2,741	2,880	3,019	3,830
108	108	1,596	1,747	2,682	2,833	2,984	3,134	3,285	4,220

		Series 30							
		Overall Finished Width							
Length	Up To	24	36	48	60	72	84	96	108
36	36	634	729	1,002	1,082	1,162	1,242	1,323	1,757
48	48	935	989	1,435	1,527	1,619	1,711	1,803	2,249
60	60	1,010	1,114	1,690	1,793	1,897	2,001	2,105	2,681
72	72	1,182	1,297	2,003	2,118	2,234	2,349	2,465	3,171
84	84	1,383	1,510	2,228	2,355	2,482	2,610	2,737	3,572
96	96	1,585	1,724	2,571	2,710	2,849	2,988	3,127	3,974
108	108	1,668	1,819	2,796	2,947	3,098	3,248	3,399	4,376

*All Décor 54 shades are recommended lined only.

FABRIC SHADES: Roman — Lined* (Lining 01000)

Chart pricing includes board mount or headrail mount. Sizes and series numbers beyond what is listed in the charts below are available—please submit these quote requests via fax or email. **NOTE: For headrail mount:** manual—maximum width 92"; motorized—maximum width 61". For larger widths, please order board mount shades.

RELAXED & SLOUCH ROMAN SHADE

		Series 07							
		Overall Finished Width							
Length	Up To	24	36	48	60	72	84	96	108
	36	346	443	525	608	690	773	855	979
	48	381	438	575	670	765	860	955	1,113
	60	368	476	646	753	861	968	1,076	1,246
	72	444	564	747	867	987	1,107	1,227	1,409
	84	469	602	797	929	1,062	1,194	1,326	1,543
	96	494	639	868	1,013	1,158	1,302	1,447	1,676
	108	570	727	969	1,126	1,283	1,441	1,598	1,839

		Series 08							
		Overall Finished Width							
Length	Up To	24	36	48	60	72	84	96	108
	36	361	458	550	633	715	798	880	1,014
	48	396	453	600	695	790	885	980	1,153
	60	383	491	676	783	891	998	1,106	1,291
	72	464	584	782	902	1,022	1,142	1,262	1,459
	84	489	622	832	964	1,097	1,229	1,361	1,598
	96	514	659	908	1,053	1,198	1,342	1,487	1,736
	108	595	752	1,014	1,171	1,328	1,486	1,643	1,904

		Series 09							
		Overall Finished Width							
Length	Up To	24	36	48	60	72	84	96	108
	36	373	470	570	653	735	818	900	1,042
	48	408	465	620	715	810	905	1,000	1,185
	60	395	503	700	807	915	1,022	1,130	1,327
	72	480	600	810	930	1,050	1,170	1,290	1,499
	84	505	638	860	992	1,125	1,257	1,389	1,642
	96	530	675	940	1,085	1,230	1,374	1,519	1,784
	108	615	772	1,050	1,207	1,364	1,522	1,679	1,956

		Series 10							
		Overall Finished Width							
Length	Up To	24	36	48	60	72	84	96	108
	36	385	482	590	673	755	838	920	1,070
	48	420	477	640	735	830	925	1,020	1,217
	60	407	515	724	831	939	1,046	1,154	1,363
	72	496	616	838	958	1,078	1,198	1,318	1,539
	84	521	654	888	1,020	1,153	1,285	1,417	1,686
	96	546	691	972	1,117	1,262	1,406	1,551	1,832
	108	635	792	1,086	1,243	1,400	1,558	1,715	2,008

		Series 11							
		Overall Finished Width							
Length	Up To	24	36	48	60	72	84	96	108
	36	397	494	610	693	775	858	940	1,098
	48	432	489	660	755	850	945	1,040	1,249
	60	419	527	748	855	963	1,070	1,178	1,399
	72	512	632	866	986	1,106	1,226	1,346	1,579
	84	537	670	916	1,048	1,181	1,313	1,445	1,730
	96	562	707	1,004	1,149	1,294	1,438	1,583	1,880
	108	655	812	1,122	1,279	1,436	1,594	1,751	2,060

		Series 12							
		Overall Finished Width							
Length	Up To	24	36	48	60	72	84	96	108
	36	409	506	630	713	795	878	960	1,126
	48	444	501	680	775	870	965	1,060	1,281
	60	431	539	772	879	987	1,094	1,202	1,435
	72	528	648	894	1,014	1,134	1,254	1,374	1,619
	84	553	686	944	1,076	1,209	1,341	1,473	1,774
	96	578	723	1,036	1,181	1,326	1,470	1,615	1,928
	108	675	832	1,158	1,315	1,472	1,630	1,787	2,112

		Series 13							
		Overall Finished Width							
Length	Up To	24	36	48	60	72	84	96	108
	36	421	518	650	733	815	898	980	1,154
	48	456	513	700	795	890	985	1,080	1,313
	60	443	551	796	903	1,011	1,118	1,226	1,471
	72	544	664	922	1,042	1,162	1,282	1,402	1,659
	84	569	702	972	1,104	1,237	1,369	1,501	1,818
	96	594	739	1,068	1,213	1,358	1,502	1,647	1,976
	108	695	852	1,194	1,351	1,508	1,666	1,823	2,164

		Series 14							
		Overall Finished Width							
Length	Up To	24	36	48	60	72	84	96	108
	36	433	530	670	753	835	918	1,000	1,182
	48	468	525	720	815	910	1,005	1,100	1,345
	60	455	563	820	927	1,035	1,142	1,250	1,507
	72	560	680	950	1,070	1,190	1,310	1,430	1,699
	84	585	718	1,000	1,132	1,265	1,397	1,529	1,862
	96	610	755	1,100	1,245	1,390	1,534	1,679	2,024
	108	715	872	1,230	1,387	1,544	1,702	1,859	2,216

		Series 15							
		Overall Finished Width							
Length	Up To	24	36	48	60	72	84	96	108
	36	445	542	690	773	855	938	1,020	1,210
	48	480	537	740	835	930	1,025	1,120	1,377
	60	467	575	844	951	1,059	1,166	1,274	1,543
	72	576	696	978	1,098	1,218	1,338	1,458	1,739
	84	601	734	1,028	1,160	1,293	1,425	1,557	1,906
	96	626	771	1,132	1,277	1,422	1,566	1,711	2,072
	108	735	892	1,266	1,423	1,580	1,738	1,895	2,268

		Series 16							
		Overall Finished Width							
Length	Up To	24	36	48	60	72	84	96	108
	36	457	554	710	793	875	958	1,040	1,238
	48	492	549	760	855	950	1,045	1,140	1,409
	60	479	587	868	975	1,083	1,190	1,298	1,579
	72	592	712	1,006	1,126	1,246	1,366	1,486	1,779
	84	617	750	1,056	1,188	1,321	1,453	1,585	1,950
	96	642	787	1,164	1,309	1,454	1,598	1,743	2,120
	108	755	912	1,302	1,459	1,616	1,774	1,931	2,320

		Series 17							
		Overall Finished Width							
Length	Up To	24	36	48	60	72	84	96	108
	36	469	566	730	813	895	978	1,060	1,266
	48	504	561	780	875	970	1,065	1,160	1,441
	60	491	599	892	999	1,107	1,214	1,322	1,615
	72	608	728	1,034	1,154	1,274	1,394	1,514	1,819
	84	633	766	1,084	1,216	1,349	1,481	1,613	1,994
	96	658	803	1,196	1,341	1,486	1,630	1,775	2,168
	108	775	932	1,338	1,495	1,652	1,810	1,967	2,372

		Series 18							
		Overall Finished Width							
Length	Up To	24	36	48	60	72	84	96	108
	36	481	578	750	833	915	998	1,080	1,294
	48	516	573	800	895	990	1,085	1,180	1,473
	60	503	611	916	1,023	1,131	1,238	1,346	1,651
	72	624	744	1,062	1,182	1,302	1,422	1,542	1,859
	84	649	782	1,112	1,244	1,377	1,509	1,641	2,038
	96	674	819	1,228	1,373	1,518	1,662	1,807	2,216
	108	795	952	1,374	1,531	1,688	1,846	2,003	2,424

*All Décor 54 shades are recommended lined only.

NOTE: For relaxed and slouch style shades, please specify the length option: to the bottom of the scallop, to the bottom of the weight bar OR straight bottom

FABRIC SHADES: Roman — Lined* (Lining 01000)

Chart pricing includes board mount or headrail mount. Sizes and series numbers beyond what is listed in the charts below are available—please submit these quote requests via fax or email. **NOTE: For headrail mount:** manual—maximum width 92"; motorized—maximum width 61". For larger widths, please order board mount shades.

RELAXED & SLOUCH ROMAN SHADE

		Series 19							
		Overall Finished Width							
Length	Up To	24	36	48	60	72	84	96	108
36	36	493	590	770	853	935	1,018	1,100	1,322
48	48	528	585	820	915	1,010	1,105	1,200	1,505
60	60	515	623	940	1,047	1,155	1,262	1,370	1,687
72	72	640	760	1,090	1,210	1,330	1,450	1,570	1,899
84	84	665	798	1,140	1,272	1,405	1,537	1,669	2,082
96	96	690	835	1,260	1,405	1,550	1,694	1,839	2,264
108	108	815	972	1,410	1,567	1,724	1,882	2,039	2,476

		Series 20							
		Overall Finished Width							
Length	Up To	24	36	48	60	72	84	96	108
36	36	505	602	790	873	955	1,038	1,120	1,350
48	48	540	597	840	935	1,030	1,125	1,220	1,537
60	60	527	635	964	1,071	1,179	1,286	1,394	1,723
72	72	656	776	1,118	1,238	1,358	1,478	1,598	1,939
84	84	681	814	1,168	1,300	1,433	1,565	1,697	2,126
96	96	706	851	1,292	1,437	1,582	1,726	1,871	2,312
108	108	835	992	1,446	1,603	1,760	1,918	2,075	2,528

		Series 21							
		Overall Finished Width							
Length	Up To	24	36	48	60	72	84	96	108
36	36	517	614	810	893	975	1,058	1,140	1,378
48	48	552	609	860	955	1,050	1,145	1,240	1,569
60	60	539	647	988	1,095	1,203	1,310	1,418	1,759
72	72	672	792	1,146	1,266	1,386	1,506	1,626	1,979
84	84	697	830	1,196	1,328	1,461	1,593	1,725	2,170
96	96	722	867	1,324	1,469	1,614	1,758	1,903	2,360
108	108	855	1,012	1,482	1,639	1,796	1,954	2,111	2,580

		Series 22							
		Overall Finished Width							
Length	Up To	24	36	48	60	72	84	96	108
36	36	529	626	830	913	995	1,078	1,160	1,406
48	48	564	621	880	975	1,070	1,165	1,260	1,601
60	60	551	659	1,012	1,119	1,227	1,334	1,442	1,795
72	72	688	808	1,174	1,294	1,414	1,534	1,654	2,019
84	84	713	846	1,224	1,356	1,489	1,621	1,753	2,214
96	96	738	883	1,356	1,501	1,646	1,790	1,935	2,408
108	108	875	1,032	1,518	1,675	1,832	1,990	2,147	2,632

		Series 23							
		Overall Finished Width							
Length	Up To	24	36	48	60	72	84	96	108
36	36	541	638	850	933	1,015	1,098	1,180	1,434
48	48	576	633	900	995	1,090	1,185	1,280	1,633
60	60	563	671	1,036	1,143	1,251	1,358	1,466	1,831
72	72	704	824	1,202	1,322	1,442	1,562	1,682	2,059
84	84	729	862	1,252	1,384	1,517	1,649	1,781	2,258
96	96	754	899	1,388	1,533	1,678	1,822	1,967	2,456
108	108	895	1,052	1,554	1,711	1,868	2,026	2,183	2,684

		Series 24							
		Overall Finished Width							
Length	Up To	24	36	48	60	72	84	96	108
36	36	553	650	870	953	1,035	1,118	1,200	1,462
48	48	588	645	920	1,015	1,110	1,205	1,300	1,665
60	60	575	683	1,060	1,167	1,275	1,382	1,490	1,867
72	72	720	840	1,230	1,350	1,470	1,590	1,710	2,099
84	84	745	878	1,280	1,412	1,545	1,677	1,809	2,302
96	96	770	915	1,420	1,565	1,710	1,854	1,999	2,504
108	108	915	1,072	1,590	1,747	1,904	2,062	2,219	2,736

		Series 25							
		Overall Finished Width							
Length	Up To	24	36	48	60	72	84	96	108
36	36	571	668	900	983	1,065	1,148	1,230	1,504
48	48	606	663	950	1,045	1,140	1,235	1,330	1,713
60	60	593	701	1,096	1,203	1,311	1,418	1,526	1,921
72	72	744	864	1,272	1,392	1,512	1,632	1,752	2,159
84	84	769	902	1,322	1,454	1,587	1,719	1,851	2,368
96	96	794	939	1,468	1,613	1,758	1,902	2,047	2,576
108	108	945	1,102	1,644	1,801	1,958	2,116	2,273	2,814

		Series 26							
		Overall Finished Width							
Length	Up To	24	36	48	60	72	84	96	108
36	36	583	680	920	1,003	1,085	1,168	1,250	1,532
48	48	618	675	970	1,065	1,160	1,255	1,350	1,745
60	60	605	713	1,120	1,227	1,335	1,442	1,550	1,957
72	72	760	880	1,300	1,420	1,540	1,660	1,780	2,199
84	84	785	918	1,350	1,482	1,615	1,747	1,879	2,412
96	96	810	955	1,500	1,645	1,790	1,934	2,079	2,624
108	108	965	1,122	1,680	1,837	1,994	2,152	2,309	2,866

		Series 27							
		Overall Finished Width							
Length	Up To	24	36	48	60	72	84	96	108
36	36	595	692	940	1,023	1,105	1,188	1,270	1,560
48	48	630	687	990	1,085	1,180	1,275	1,370	1,777
60	60	617	725	1,144	1,251	1,359	1,466	1,574	1,993
72	72	776	896	1,328	1,448	1,568	1,688	1,808	2,239
84	84	801	934	1,378	1,510	1,643	1,775	1,907	2,456
96	96	826	971	1,532	1,677	1,822	1,966	2,111	2,672
108	108	985	1,142	1,716	1,873	2,030	2,188	2,345	2,918

		Series 28							
		Overall Finished Width							
Length	Up To	24	36	48	60	72	84	96	108
36	36	607	704	960	1,043	1,125	1,208	1,290	1,588
48	48	642	699	1,010	1,105	1,200	1,295	1,390	1,809
60	60	629	737	1,168	1,275	1,383	1,490	1,598	2,029
72	72	792	912	1,356	1,476	1,596	1,716	1,836	2,279
84	84	817	950	1,406	1,538	1,671	1,803	1,935	2,500
96	96	842	987	1,564	1,709	1,854	1,998	2,143	2,720
108	108	1,005	1,162	1,752	1,909	2,066	2,224	2,381	2,970

		Series 29							
		Overall Finished Width							
Length	Up To	24	36	48	60	72	84	96	108
36	36	619	716	980	1,063	1,145	1,228	1,310	1,616
48	48	654	711	1,030	1,125	1,220	1,315	1,410	1,841
60	60	641	749	1,192	1,299	1,407	1,514	1,622	2,065
72	72	808	928	1,384	1,504	1,624	1,744	1,864	2,319
84	84	833	966	1,434	1,566	1,699	1,831	1,963	2,544
96	96	858	1,003	1,596	1,741	1,886	2,030	2,175	2,768
108	108	1,025	1,182	1,788	1,945	2,102	2,260	2,417	3,022

		Series 30							
		Overall Finished Width							
Length	Up To	24	36	48	60	72	84	96	108
36	36	637	734	1,010	1,093	1,175	1,258	1,340	1,658
48	48	672	729	1,060	1,155	1,250	1,345	1,440	1,889
60	60	659	767	1,228	1,335	1,443	1,550	1,658	2,119
72	72	832	952	1,426	1,546	1,666	1,786	1,906	2,379
84	84	857	990	1,476	1,608	1,741	1,873	2,005	2,610
96	96	882	1,027	1,644	1,789	1,934	2,078	2,223	2,840
108	108	1,055	1,212	1,842	1,999	2,156	2,314	2,471	3,100

*All Décor 54 shades are recommended lined only.

NOTE: For relaxed and slouch style shades, please specify the length option: to the bottom of the scallop, to the bottom of the weight bar OR straight bottom

FABRIC SHADES: Roman — Lined* (Lining 01000)

Chart pricing includes board mount or headrail mount. Sizes and series numbers beyond what is listed in the charts below are available—please submit these quote requests via fax or email. **NOTE: For headrail mount:** manual—maximum width 87"; motorized—maximum width 56". For larger widths, please order board mount shades.

BUTTERFLY ROMAN SHADE

		Series 07							
		Overall Finished Width							
Length	Up To	24	36	48	60	72	84	96	108
	36	346	443	525	608	690	773	897	1,039
	48	381	438	575	670	765	860	1,018	1,173
	60	368	476	646	753	861	968	1,139	1,336
	72	444	564	747	867	987	1,107	1,290	1,499
	84	469	602	797	929	1,062	1,194	1,410	1,633
	96	494	639	868	1,013	1,158	1,302	1,531	1,796
	108	570	727	969	1,126	1,283	1,441	1,682	1,959

		Series 08							
		Overall Finished Width							
Length	Up To	24	36	48	60	72	84	96	108
	36	361	458	550	633	715	798	932	1,074
	48	396	453	600	695	790	885	1,058	1,213
	60	383	491	676	783	891	998	1,184	1,381
	72	464	584	782	902	1,022	1,142	1,340	1,549
	84	489	622	832	964	1,097	1,229	1,465	1,688
	96	514	659	908	1,053	1,198	1,342	1,591	1,856
	108	595	752	1,014	1,171	1,328	1,486	1,747	2,024

		Series 09							
		Overall Finished Width							
Length	Up To	24	36	48	60	72	84	96	108
	36	373	470	570	653	735	818	960	1,102
	48	408	465	620	715	810	905	1,090	1,245
	60	395	503	700	807	915	1,022	1,220	1,417
	72	480	600	810	930	1,050	1,170	1,380	1,589
	84	505	638	860	992	1,125	1,257	1,509	1,732
	96	530	675	940	1,085	1,230	1,374	1,639	1,904
	108	615	772	1,050	1,207	1,364	1,522	1,799	2,076

		Series 10							
		Overall Finished Width							
Length	Up To	24	36	48	60	72	84	96	108
	36	385	482	590	673	755	838	988	1,130
	48	420	477	640	735	830	925	1,122	1,277
	60	407	515	724	831	939	1,046	1,256	1,453
	72	496	616	838	958	1,078	1,198	1,420	1,629
	84	521	654	888	1,020	1,153	1,285	1,553	1,776
	96	546	691	972	1,117	1,262	1,406	1,687	1,952
	108	635	792	1,086	1,243	1,400	1,558	1,851	2,128

		Series 11							
		Overall Finished Width							
Length	Up To	24	36	48	60	72	84	96	108
	36	397	494	610	693	775	858	1,016	1,158
	48	432	489	660	755	850	945	1,154	1,309
	60	419	527	748	855	963	1,070	1,292	1,489
	72	512	632	866	986	1,106	1,226	1,460	1,669
	84	537	670	916	1,048	1,181	1,313	1,597	1,820
	96	562	707	1,004	1,149	1,294	1,438	1,735	2,000
	108	655	812	1,122	1,279	1,436	1,594	1,903	2,180

		Series 12							
		Overall Finished Width							
Length	Up To	24	36	48	60	72	84	96	108
	36	409	506	630	713	795	878	1,044	1,186
	48	444	501	680	775	870	965	1,186	1,341
	60	431	539	772	879	987	1,094	1,328	1,525
	72	528	648	894	1,014	1,134	1,254	1,500	1,709
	84	553	686	944	1,076	1,209	1,341	1,641	1,864
	96	578	723	1,036	1,181	1,326	1,470	1,783	2,048
	108	675	832	1,158	1,315	1,472	1,630	1,955	2,232

		Series 13							
		Overall Finished Width							
Length	Up To	24	36	48	60	72	84	96	108
	36	421	518	650	733	815	898	1,072	1,214
	48	456	513	700	795	890	985	1,218	1,373
	60	443	551	796	903	1,011	1,118	1,364	1,561
	72	544	664	922	1,042	1,162	1,282	1,540	1,749
	84	569	702	972	1,104	1,237	1,369	1,685	1,908
	96	594	739	1,068	1,213	1,358	1,502	1,831	2,096
	108	695	852	1,194	1,351	1,508	1,666	2,007	2,284

		Series 14							
		Overall Finished Width							
Length	Up To	24	36	48	60	72	84	96	108
	36	433	530	670	753	835	918	1,100	1,242
	48	468	525	720	815	910	1,005	1,250	1,405
	60	455	563	820	927	1,035	1,142	1,400	1,597
	72	560	680	950	1,070	1,190	1,310	1,580	1,789
	84	585	718	1,000	1,132	1,265	1,397	1,729	1,952
	96	610	755	1,100	1,245	1,390	1,534	1,879	2,144
	108	715	872	1,230	1,387	1,544	1,702	2,059	2,336

		Series 15							
		Overall Finished Width							
Length	Up To	24	36	48	60	72	84	96	108
	36	445	542	690	773	855	938	1,128	1,270
	48	480	537	740	835	930	1,025	1,282	1,437
	60	467	575	844	951	1,059	1,166	1,436	1,633
	72	576	696	978	1,098	1,218	1,338	1,620	1,829
	84	601	734	1,028	1,160	1,293	1,425	1,773	1,996
	96	626	771	1,132	1,277	1,422	1,566	1,927	2,192
	108	735	892	1,266	1,423	1,580	1,738	2,111	2,388

		Series 16							
		Overall Finished Width							
Length	Up To	24	36	48	60	72	84	96	108
	36	457	554	710	793	875	958	1,156	1,298
	48	492	549	760	855	950	1,045	1,314	1,469
	60	479	587	868	975	1,083	1,190	1,472	1,669
	72	592	712	1,006	1,126	1,246	1,366	1,660	1,869
	84	617	750	1,056	1,188	1,321	1,453	1,817	2,040
	96	642	787	1,164	1,309	1,454	1,598	1,975	2,240
	108	755	912	1,302	1,459	1,616	1,774	2,163	2,440

		Series 17							
		Overall Finished Width							
Length	Up To	24	36	48	60	72	84	96	108
	36	469	566	730	813	895	978	1,184	1,326
	48	504	561	780	875	970	1,065	1,346	1,501
	60	491	599	892	999	1,107	1,214	1,508	1,705
	72	608	728	1,034	1,154	1,274	1,394	1,700	1,909
	84	633	766	1,084	1,216	1,349	1,481	1,861	2,084
	96	658	803	1,196	1,341	1,486	1,630	2,023	2,288
	108	775	932	1,338	1,495	1,652	1,810	2,215	2,492

		Series 18							
		Overall Finished Width							
Length	Up To	24	36	48	60	72	84	96	108
	36	481	578	750	833	915	998	1,212	1,354
	48	516	573	800	895	990	1,085	1,378	1,533
	60	503	611	916	1,023	1,131	1,238	1,544	1,741
	72	624	744	1,062	1,182	1,302	1,422	1,740	1,949
	84	649	782	1,112	1,244	1,377	1,509	1,905	2,128
	96	674	819	1,228	1,373	1,518	1,662	2,071	2,336
	108	795	952	1,374	1,531	1,688	1,846	2,267	2,544

*All Décor 54 shades are recommended lined only.

NOTE: For butterfly style shades, please specify the length option: to the bottom of the scallop, to the bottom of the weight bar OR straight bottom

FABRIC SHADES: Roman — Lined* (Lining 01000)

Chart pricing includes board mount or headrail mount. Sizes and series numbers beyond what is listed in the charts below are available—please submit these quote requests via fax or email. **NOTE: For headrail mount:** manual—maximum width 87"; motorized—maximum width 56". For larger widths, please order board mount shades.

BUTTERFLY ROMAN SHADE

		Series 19							
		Overall Finished Width							
Length	Up To	24	36	48	60	72	84	96	108
36	36	493	590	770	853	935	1,018	1,240	1,382
48	48	528	585	820	915	1,010	1,105	1,410	1,565
60	60	515	623	940	1,047	1,155	1,262	1,580	1,777
72	72	640	760	1,090	1,210	1,330	1,450	1,780	1,989
84	84	665	798	1,140	1,272	1,405	1,537	1,949	2,172
96	96	690	835	1,260	1,405	1,550	1,694	2,119	2,384
108	108	815	972	1,410	1,567	1,724	1,882	2,319	2,596

		Series 20							
		Overall Finished Width							
Length	Up To	24	36	48	60	72	84	96	108
36	36	505	602	790	873	955	1,038	1,268	1,410
48	48	540	597	840	935	1,030	1,125	1,442	1,597
60	60	527	635	964	1,071	1,179	1,286	1,616	1,813
72	72	656	776	1,118	1,238	1,358	1,478	1,820	2,029
84	84	681	814	1,168	1,300	1,433	1,565	1,993	2,216
96	96	706	851	1,292	1,437	1,582	1,726	2,167	2,432
108	108	835	992	1,446	1,603	1,760	1,918	2,371	2,648

		Series 21							
		Overall Finished Width							
Length	Up To	24	36	48	60	72	84	96	108
36	36	517	614	810	893	975	1,058	1,296	1,438
48	48	552	609	860	955	1,050	1,145	1,474	1,629
60	60	539	647	988	1,095	1,203	1,310	1,652	1,849
72	72	672	792	1,146	1,266	1,386	1,506	1,860	2,069
84	84	697	830	1,196	1,328	1,461	1,593	2,037	2,260
96	96	722	867	1,324	1,469	1,614	1,758	2,215	2,480
108	108	855	1,012	1,482	1,639	1,796	1,954	2,423	2,700

		Series 22							
		Overall Finished Width							
Length	Up To	24	36	48	60	72	84	96	108
36	36	529	626	830	913	995	1,078	1,324	1,466
48	48	564	621	880	975	1,070	1,165	1,506	1,661
60	60	551	659	1,012	1,119	1,227	1,334	1,688	1,885
72	72	688	808	1,174	1,294	1,414	1,534	1,900	2,109
84	84	713	846	1,224	1,356	1,489	1,621	2,081	2,304
96	96	738	883	1,356	1,501	1,646	1,790	2,263	2,528
108	108	875	1,032	1,518	1,675	1,832	1,990	2,475	2,752

		Series 23							
		Overall Finished Width							
Length	Up To	24	36	48	60	72	84	96	108
36	36	541	638	850	933	1,015	1,098	1,352	1,494
48	48	576	633	900	995	1,090	1,185	1,538	1,693
60	60	563	671	1,036	1,143	1,251	1,358	1,724	1,921
72	72	704	824	1,202	1,322	1,442	1,562	1,940	2,149
84	84	729	862	1,252	1,384	1,517	1,649	2,125	2,348
96	96	754	899	1,388	1,533	1,678	1,822	2,311	2,576
108	108	895	1,052	1,554	1,711	1,868	2,026	2,527	2,804

		Series 24							
		Overall Finished Width							
Length	Up To	24	36	48	60	72	84	96	108
36	36	553	650	870	953	1,035	1,118	1,380	1,522
48	48	588	645	920	1,015	1,110	1,205	1,570	1,725
60	60	575	683	1,060	1,167	1,275	1,382	1,760	1,957
72	72	720	840	1,230	1,350	1,470	1,590	1,980	2,189
84	84	745	878	1,280	1,412	1,545	1,677	2,169	2,392
96	96	770	915	1,420	1,565	1,710	1,854	2,359	2,624
108	108	915	1,072	1,590	1,747	1,904	2,062	2,579	2,856

		Series 25							
		Overall Finished Width							
Length	Up To	24	36	48	60	72	84	96	108
36	36	571	668	900	983	1,065	1,148	1,422	1,564
48	48	606	663	950	1,045	1,140	1,235	1,618	1,773
60	60	593	701	1,096	1,203	1,311	1,418	1,814	2,011
72	72	744	864	1,272	1,392	1,512	1,632	2,040	2,249
84	84	769	902	1,322	1,454	1,587	1,719	2,235	2,458
96	96	794	939	1,468	1,613	1,758	1,902	2,431	2,696
108	108	945	1,102	1,644	1,801	1,958	2,116	2,657	2,934

		Series 26							
		Overall Finished Width							
Length	Up To	24	36	48	60	72	84	96	108
36	36	583	680	920	1,003	1,085	1,168	1,450	1,592
48	48	618	675	970	1,065	1,160	1,255	1,650	1,805
60	60	605	713	1,120	1,227	1,335	1,442	1,850	2,047
72	72	760	880	1,300	1,420	1,540	1,660	2,080	2,289
84	84	785	918	1,350	1,482	1,615	1,747	2,279	2,502
96	96	810	955	1,500	1,645	1,790	1,934	2,479	2,744
108	108	965	1,122	1,680	1,837	1,994	2,152	2,709	2,986

		Series 27							
		Overall Finished Width							
Length	Up To	24	36	48	60	72	84	96	108
36	36	595	692	940	1,023	1,105	1,188	1,478	1,620
48	48	630	687	990	1,085	1,180	1,275	1,682	1,837
60	60	617	725	1,144	1,251	1,359	1,466	1,886	2,083
72	72	776	896	1,328	1,448	1,568	1,688	2,120	2,329
84	84	801	934	1,378	1,510	1,643	1,775	2,323	2,546
96	96	826	971	1,532	1,677	1,822	1,966	2,527	2,792
108	108	985	1,142	1,716	1,873	2,030	2,188	2,761	3,038

		Series 28							
		Overall Finished Width							
Length	Up To	24	36	48	60	72	84	96	108
36	36	607	704	960	1,043	1,125	1,208	1,506	1,648
48	48	642	699	1,010	1,105	1,200	1,295	1,714	1,869
60	60	629	737	1,168	1,275	1,383	1,490	1,922	2,119
72	72	792	912	1,356	1,476	1,596	1,716	2,160	2,369
84	84	817	950	1,406	1,538	1,671	1,803	2,367	2,590
96	96	842	987	1,564	1,709	1,854	1,998	2,575	2,840
108	108	1,005	1,162	1,752	1,909	2,066	2,224	2,813	3,090

		Series 29							
		Overall Finished Width							
Length	Up To	24	36	48	60	72	84	96	108
36	36	619	716	980	1,063	1,145	1,228	1,534	1,676
48	48	654	711	1,030	1,125	1,220	1,315	1,746	1,901
60	60	641	749	1,192	1,299	1,407	1,514	1,958	2,155
72	72	808	928	1,384	1,504	1,624	1,744	2,200	2,409
84	84	833	966	1,434	1,566	1,699	1,831	2,411	2,634
96	96	858	1,003	1,596	1,741	1,886	2,030	2,623	2,888
108	108	1,025	1,182	1,788	1,945	2,102	2,260	2,865	3,142

		Series 30							
		Overall Finished Width							
Length	Up To	24	36	48	60	72	84	96	108
36	36	637	734	1,010	1,093	1,175	1,258	1,576	1,718
48	48	672	729	1,060	1,155	1,250	1,345	1,794	1,949
60	60	659	767	1,228	1,335	1,443	1,550	2,012	2,209
72	72	832	952	1,426	1,546	1,666	1,786	2,260	2,469
84	84	857	990	1,476	1,608	1,741	1,873	2,477	2,700
96	96	882	1,027	1,644	1,789	1,934	2,078	2,695	2,960
108	108	1,055	1,212	1,842	1,999	2,156	2,314	2,943	3,220

*All Décor 54 shades are recommended lined only.

NOTE: For butterfly style shades, please specify the length option: to the bottom of the scallop, to the bottom of the weight bar OR straight bottom

FABRIC SHADES: Balloon — Lined* (Lining 01000)

Chart pricing includes board mount or headrail mount. Sizes and series numbers beyond what is listed in the charts below are available—please submit these quote requests via fax or email. **NOTE: For headrail mount:** manual—maximum width 64" and maximum length 72"; motorized—maximum width 42" and maximum length 72". For larger widths, please order board mount shades. **NOTE: For board mount:** manual—maximum width 108" and maximum length 120".

SHIRRED & BOX PLEATED BALLOON SHADE

		Series 07							
		Overall Finished Width							
Length	Up To	24	36	48	60	72	84	96	108
36	36	402	506	641	769	855	983	1,128	1,256
48	48	441	494	716	858	957	1,120	1,309	1,451
60	60	443	556	822	998	1,111	1,266	1,469	1,645
72	72	521	648	927	1,117	1,244	1,434	1,650	1,840
84	84	548	689	1,003	1,206	1,347	1,571	1,831	2,035
96	96	596	750	1,108	1,346	1,500	1,717	1,991	2,229
108	108	675	842	1,214	1,465	1,633	1,885	2,172	2,424

		Series 08							
		Overall Finished Width							
Length	Up To	24	36	48	60	72	84	96	108
36	36	427	531	676	814	900	1,038	1,183	1,321
48	48	466	519	756	908	1,007	1,185	1,374	1,526
60	60	473	586	867	1,058	1,171	1,336	1,539	1,730
72	72	556	683	977	1,182	1,309	1,514	1,730	1,935
84	84	583	724	1,058	1,276	1,417	1,661	1,921	2,140
96	96	636	790	1,168	1,426	1,580	1,812	2,086	2,344
108	108	720	887	1,279	1,550	1,718	1,990	2,277	2,549

		Series 09							
		Overall Finished Width							
Length	Up To	24	36	48	60	72	84	96	108
36	36	447	551	704	850	936	1,082	1,227	1,373
48	48	486	539	788	948	1,047	1,237	1,426	1,586
60	60	497	610	903	1,106	1,219	1,392	1,595	1,798
72	72	584	711	1,017	1,234	1,361	1,578	1,794	2,011
84	84	611	752	1,102	1,332	1,473	1,733	1,993	2,224
96	96	668	822	1,216	1,490	1,644	1,888	2,162	2,436
108	108	756	923	1,331	1,618	1,786	2,074	2,361	2,649

		Series 10							
		Overall Finished Width							
Length	Up To	24	36	48	60	72	84	96	108
36	36	467	571	732	886	972	1,126	1,271	1,425
48	48	506	559	820	988	1,087	1,289	1,478	1,646
60	60	521	634	939	1,154	1,267	1,448	1,651	1,866
72	72	612	739	1,057	1,286	1,413	1,642	1,858	2,087
84	84	639	780	1,146	1,388	1,529	1,805	2,065	2,308
96	96	700	854	1,264	1,554	1,708	1,964	2,238	2,528
108	108	792	959	1,383	1,686	1,854	2,158	2,445	2,749

		Series 11							
		Overall Finished Width							
Length	Up To	24	36	48	60	72	84	96	108
36	36	487	591	760	922	1,008	1,170	1,315	1,477
48	48	526	579	852	1,028	1,127	1,341	1,530	1,706
60	60	545	658	975	1,202	1,315	1,504	1,707	1,934
72	72	640	767	1,097	1,338	1,465	1,706	1,922	2,163
84	84	667	808	1,190	1,444	1,585	1,877	2,137	2,392
96	96	732	886	1,312	1,618	1,772	2,040	2,314	2,620
108	108	828	995	1,435	1,754	1,922	2,242	2,529	2,849

		Series 12							
		Overall Finished Width							
Length	Up To	24	36	48	60	72	84	96	108
36	36	507	611	788	958	1,044	1,214	1,359	1,529
48	48	546	599	884	1,068	1,167	1,393	1,582	1,766
60	60	569	682	1,011	1,250	1,363	1,560	1,763	2,002
72	72	668	795	1,137	1,390	1,517	1,770	1,986	2,239
84	84	695	836	1,234	1,500	1,641	1,949	2,209	2,476
96	96	764	918	1,360	1,682	1,836	2,116	2,390	2,712
108	108	864	1,031	1,487	1,822	1,990	2,326	2,613	2,949

		Series 13							
		Overall Finished Width							
Length	Up To	24	36	48	60	72	84	96	108
36	36	527	631	816	994	1,080	1,258	1,403	1,581
48	48	566	619	916	1,108	1,207	1,445	1,634	1,826
60	60	593	706	1,047	1,298	1,411	1,616	1,819	2,070
72	72	696	823	1,177	1,442	1,569	1,834	2,050	2,315
84	84	723	864	1,278	1,556	1,697	2,021	2,281	2,560
96	96	796	950	1,408	1,746	1,900	2,192	2,466	2,804
108	108	900	1,067	1,539	1,890	2,058	2,410	2,697	3,049

		Series 14							
		Overall Finished Width							
Length	Up To	24	36	48	60	72	84	96	108
36	36	547	651	844	1,030	1,116	1,302	1,447	1,633
48	48	586	639	948	1,148	1,247	1,497	1,686	1,886
60	60	617	730	1,083	1,346	1,459	1,672	1,875	2,138
72	72	724	851	1,217	1,494	1,621	1,898	2,114	2,391
84	84	751	892	1,322	1,612	1,753	2,093	2,353	2,644
96	96	828	982	1,456	1,810	1,964	2,268	2,542	2,896
108	108	936	1,103	1,591	1,958	2,126	2,494	2,781	3,149

		Series 15							
		Overall Finished Width							
Length	Up To	24	36	48	60	72	84	96	108
36	36	567	671	872	1,066	1,152	1,346	1,491	1,685
48	48	606	659	980	1,188	1,287	1,549	1,738	1,946
60	60	641	754	1,119	1,394	1,507	1,728	1,931	2,206
72	72	752	879	1,257	1,546	1,673	1,962	2,178	2,467
84	84	779	920	1,366	1,668	1,809	2,165	2,425	2,728
96	96	860	1,014	1,504	1,874	2,028	2,344	2,618	2,988
108	108	972	1,139	1,643	2,026	2,194	2,578	2,865	3,249

		Series 16							
		Overall Finished Width							
Length	Up To	24	36	48	60	72	84	96	108
36	36	587	691	900	1,102	1,188	1,390	1,535	1,737
48	48	626	679	1,012	1,228	1,327	1,601	1,790	2,006
60	60	665	778	1,155	1,442	1,555	1,784	1,987	2,274
72	72	780	907	1,297	1,598	1,725	2,026	2,242	2,543
84	84	807	948	1,410	1,724	1,865	2,237	2,497	2,812
96	96	892	1,046	1,552	1,938	2,092	2,420	2,694	3,080
108	108	1,008	1,175	1,695	2,094	2,262	2,662	2,949	3,349

		Series 17							
		Overall Finished Width							
Length	Up To	24	36	48	60	72	84	96	108
36	36	607	711	928	1,138	1,224	1,434	1,579	1,789
48	48	646	699	1,044	1,268	1,367	1,653	1,842	2,066
60	60	689	802	1,191	1,490	1,603	1,840	2,043	2,342
72	72	808	935	1,337	1,650	1,777	2,090	2,306	2,619
84	84	835	976	1,454	1,780	1,921	2,309	2,569	2,896
96	96	924	1,078	1,600	2,002	2,156	2,496	2,770	3,172
108	108	1,044	1,211	1,747	2,162	2,330	2,746	3,033	3,449

		Series 18							
		Overall Finished Width							
Length	Up To	24	36	48	60	72	84	96	108
36	36	627	731	956	1,174	1,260	1,478	1,623	1,841
48	48	666	719	1,076	1,308	1,407	1,705	1,894	2,126
60	60	713	826	1,227	1,538	1,651	1,896	2,099	2,410
72	72	836	963	1,377	1,702	1,829	2,154	2,370	2,695
84	84	863	1,004	1,498	1,836	1,977	2,381	2,641	2,980
96	96	956	1,110	1,648	2,066	2,220	2,572	2,846	3,264
108	108	1,080	1,247	1,799	2,230	2,398	2,830	3,117	3,549

*All Décor 54 shades are recommended lined only.

NOTE: For balloon style shades, please specify the length option: to the bottom of the scallop, to the bottom of the weight bar OR straight bottom

FABRIC SHADES: Balloon — Lined* (Lining 01000)

Chart pricing includes board mount or headrail mount. Sizes and series numbers beyond what is listed in the charts below are available—please submit these quote requests via fax or email. **NOTE: For headrail mount:** manual—maximum width 64" and maximum length 72"; motorized—maximum width 42" and maximum length 72". For larger widths, please order board mount shades. **NOTE: For board mount:** manual—maximum width 108" and maximum length 120".

SHIRRED & BOX PLEATED BALLOON SHADE

		Series 19							
		Overall Finished Width							
Length	Up To	24	36	48	60	72	84	96	108
36	36	647	751	984	1,210	1,296	1,522	1,667	1,893
48	48	686	739	1,108	1,348	1,447	1,757	1,946	2,186
60	60	737	850	1,263	1,586	1,699	1,952	2,155	2,478
72	72	864	991	1,417	1,754	1,881	2,218	2,434	2,771
84	84	891	1,032	1,542	1,892	2,033	2,453	2,713	3,064
96	96	988	1,142	1,696	2,130	2,284	2,648	2,922	3,356
108	108	1,116	1,283	1,851	2,298	2,466	2,914	3,201	3,649

		Series 20							
		Overall Finished Width							
Length	Up To	24	36	48	60	72	84	96	108
36	36	667	771	1,012	1,246	1,332	1,566	1,711	1,945
48	48	706	759	1,140	1,388	1,487	1,809	1,998	2,246
60	60	761	874	1,299	1,634	1,747	2,008	2,211	2,546
72	72	892	1,019	1,457	1,806	1,933	2,282	2,498	2,847
84	84	919	1,060	1,586	1,948	2,089	2,525	2,785	3,148
96	96	1,020	1,174	1,744	2,194	2,348	2,724	2,998	3,448
108	108	1,152	1,319	1,903	2,366	2,534	2,998	3,285	3,749

		Series 21							
		Overall Finished Width							
Length	Up To	24	36	48	60	72	84	96	108
36	36	687	791	1,040	1,282	1,368	1,610	1,755	1,997
48	48	726	779	1,172	1,428	1,527	1,861	2,050	2,306
60	60	785	898	1,335	1,682	1,795	2,064	2,267	2,614
72	72	920	1,047	1,497	1,858	1,985	2,346	2,562	2,923
84	84	947	1,088	1,630	2,004	2,145	2,597	2,857	3,232
96	96	1,052	1,206	1,792	2,258	2,412	2,800	3,074	3,540
108	108	1,188	1,355	1,955	2,434	2,602	3,082	3,369	3,849

		Series 22							
		Overall Finished Width							
Length	Up To	24	36	48	60	72	84	96	108
36	36	707	811	1,068	1,318	1,404	1,654	1,799	2,049
48	48	746	799	1,204	1,468	1,567	1,913	2,102	2,366
60	60	809	922	1,371	1,730	1,843	2,120	2,323	2,682
72	72	948	1,075	1,537	1,910	2,037	2,410	2,626	2,999
84	84	975	1,116	1,674	2,060	2,201	2,669	2,929	3,316
96	96	1,084	1,238	1,840	2,322	2,476	2,876	3,150	3,632
108	108	1,224	1,391	2,007	2,502	2,670	3,166	3,453	3,949

		Series 23							
		Overall Finished Width							
Length	Up To	24	36	48	60	72	84	96	108
36	36	727	831	1,096	1,354	1,440	1,698	1,843	2,101
48	48	766	819	1,236	1,508	1,607	1,965	2,154	2,426
60	60	833	946	1,407	1,778	1,891	2,176	2,379	2,750
72	72	976	1,103	1,577	1,962	2,089	2,474	2,690	3,075
84	84	1,003	1,144	1,718	2,116	2,257	2,741	3,001	3,400
96	96	1,116	1,270	1,888	2,386	2,540	2,952	3,226	3,724
108	108	1,260	1,427	2,059	2,570	2,738	3,250	3,537	4,049

		Series 24							
		Overall Finished Width							
Length	Up To	24	36	48	60	72	84	96	108
36	36	747	851	1,124	1,390	1,476	1,742	1,887	2,153
48	48	786	839	1,268	1,548	1,647	2,017	2,206	2,486
60	60	857	970	1,443	1,826	1,939	2,232	2,435	2,818
72	72	1,004	1,131	1,617	2,014	2,141	2,538	2,754	3,151
84	84	1,031	1,172	1,762	2,172	2,313	2,813	3,073	3,484
96	96	1,148	1,302	1,936	2,450	2,604	3,028	3,302	3,816
108	108	1,296	1,463	2,111	2,638	2,806	3,334	3,621	4,149

		Series 25							
		Overall Finished Width							
Length	Up To	24	36	48	60	72	84	96	108
36	36	777	881	1,166	1,444	1,530	1,808	1,953	2,231
48	48	816	869	1,316	1,608	1,707	2,095	2,284	2,576
60	60	893	1,006	1,497	1,898	2,011	2,316	2,519	2,920
72	72	1,046	1,173	1,677	2,092	2,219	2,634	2,850	3,265
84	84	1,073	1,214	1,828	2,256	2,397	2,921	3,181	3,610
96	96	1,196	1,350	2,008	2,546	2,700	3,142	3,416	3,954
108	108	1,350	1,517	2,189	2,740	2,908	3,460	3,747	4,299

		Series 26							
		Overall Finished Width							
Length	Up To	24	36	48	60	72	84	96	108
36	36	797	901	1,194	1,480	1,566	1,852	1,997	2,283
48	48	836	889	1,348	1,648	1,747	2,147	2,336	2,636
60	60	917	1,030	1,533	1,946	2,059	2,372	2,575	2,988
72	72	1,074	1,201	1,717	2,144	2,271	2,698	2,914	3,341
84	84	1,101	1,242	1,872	2,312	2,453	2,993	3,253	3,694
96	96	1,228	1,382	2,056	2,610	2,764	3,218	3,492	4,046
108	108	1,386	1,553	2,241	2,808	2,976	3,544	3,831	4,399

		Series 27							
		Overall Finished Width							
Length	Up To	24	36	48	60	72	84	96	108
36	36	817	921	1,222	1,516	1,602	1,896	2,041	2,335
48	48	856	909	1,380	1,688	1,787	2,199	2,388	2,696
60	60	941	1,054	1,569	1,994	2,107	2,428	2,631	3,056
72	72	1,102	1,229	1,757	2,196	2,323	2,762	2,978	3,417
84	84	1,129	1,270	1,916	2,368	2,509	3,065	3,325	3,778
96	96	1,260	1,414	2,104	2,674	2,828	3,294	3,568	4,138
108	108	1,422	1,589	2,293	2,876	3,044	3,628	3,915	4,499

		Series 28							
		Overall Finished Width							
Length	Up To	24	36	48	60	72	84	96	108
36	36	837	941	1,250	1,552	1,638	1,940	2,085	2,387
48	48	876	929	1,412	1,728	1,827	2,251	2,440	2,756
60	60	965	1,078	1,605	2,042	2,155	2,484	2,687	3,124
72	72	1,130	1,257	1,797	2,248	2,375	2,826	3,042	3,493
84	84	1,157	1,298	1,960	2,424	2,565	3,137	3,397	3,862
96	96	1,292	1,446	2,152	2,738	2,892	3,370	3,644	4,230
108	108	1,458	1,625	2,345	2,944	3,112	3,712	3,999	4,599

		Series 29							
		Overall Finished Width							
Length	Up To	24	36	48	60	72	84	96	108
36	36	857	961	1,278	1,588	1,674	1,984	2,129	2,439
48	48	896	949	1,444	1,768	1,867	2,303	2,492	2,816
60	60	989	1,102	1,641	2,090	2,203	2,540	2,743	3,192
72	72	1,158	1,285	1,837	2,300	2,427	2,890	3,106	3,569
84	84	1,185	1,326	2,004	2,480	2,621	3,209	3,469	3,946
96	96	1,324	1,478	2,200	2,802	2,956	3,446	3,720	4,322
108	108	1,494	1,661	2,397	3,012	3,180	3,796	4,083	4,699

		Series 30							
		Overall Finished Width							
Length	Up To	24	36	48	60	72	84	96	108
36	36	887	991	1,320	1,642	1,728	2,050	2,195	2,517
48	48	926	979	1,492	1,828	1,927	2,381	2,570	2,906
60	60	1,025	1,138	1,695	2,162	2,275	2,624	2,827	3,294
72	72	1,200	1,327	1,897	2,378	2,505	2,986	3,202	3,683
84	84	1,227	1,368	2,070	2,564	2,705	3,317	3,577	4,072
96	96	1,372	1,526	2,272	2,898	3,052	3,560	3,834	4,460
108	108	1,548	1,715	2,475	3,114	3,282	3,922	4,209	4,849

*All Décor 54 shades are recommended lined only.

NOTE: For balloon style shades, please specify the length option: to the bottom of the scallop, to the bottom of the weight bar OR straight bottom

SHIPPING INFORMATION

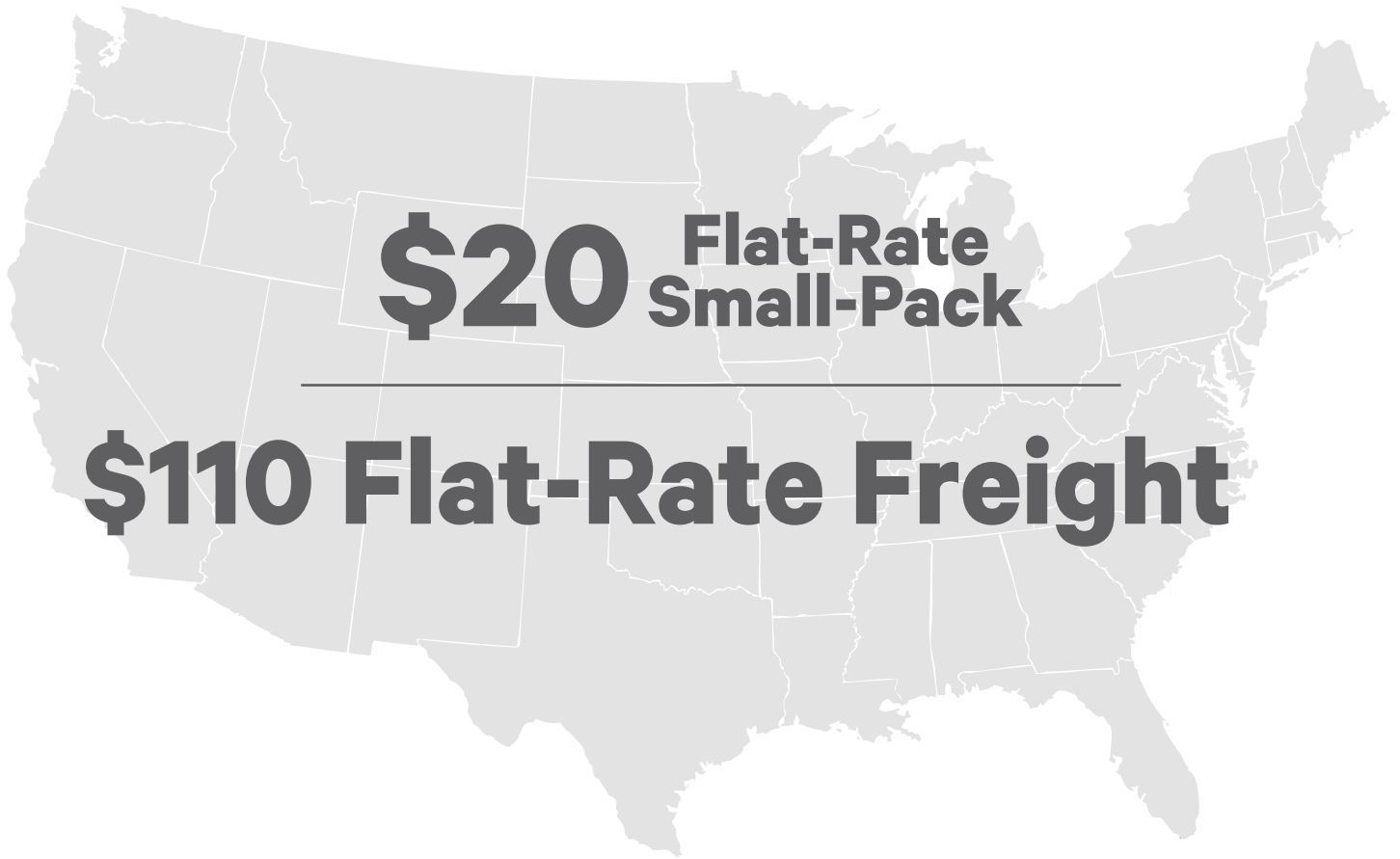

Flat Shipping Rate

- flair21 is pleased to offer a flat ground shipping rate of \$20 per customer order confirmation in the United States.
- All orders ship from our plant in Spartanburg, South Carolina.
- Our \$20 flat rate is for small packages only. Larger packages are shipped via freight.

When Do We Ship Via Freight?

- Packages EXCEEDING 105" in length, 130" in total girth (length+width twice+height twice) and/or 150 lbs. in weight must be shipped via freight.
- Board mounted top treatments over 67" wide will also be shipped via freight. Board mounted top treatments exceeding 150" in width are crated to prevent damage in transit, and will incur a crating fee (see below).

Crating Charges for Oversized Board Mounted Treatments

150" – 199"	200" – 249"	250" – 299"	> 300"
\$50	\$80	\$110	\$150

Other Important Points:

- IF THERE IS ANY EVIDENCE OF LOSS OR EXTERIOR DAMAGE, DO NOT ACCEPT THE SHIPMENT UNTIL THE DELIVERING CARRIER'S AGENT HAS MADE A NOTATION (OF LOSS OR DAMAGE) ON THE PROOF OF DELIVERY RECEIPT.
- By knowing your shipping rate in advance, you can better prepare your quote accordingly.
- We prepay the freight charge and add it to your invoice.
- We do NOT charge an additional fee for residential delivery.

WORRY-FREE GUARANTEE



We strive to provide the highest quality products—engineered to last a lifetime. This starts with manufacturing fabrics using state-of-the-art techniques, and then hand crafting them into beautifully-functioning window treatments. We use only the highest quality materials in ISO-certified processes, which ultimately leads to reliable products. As an expression of the confidence we have in our products, flair21 fabrics come with a 5-year guarantee not to shrink, stretch or fade, and every finished product comes with the following limited lifetime warranty:

COVERED BY A LIMITED LIFETIME WARRANTY

- ✓ flair21 warrants its products for defects in materials, workmanship or failure to operate for as long as the original retail purchaser owns the product (unless shorter periods are provided below).
- ✓ Vertical Wrap vanes for 3 years from purchase date.
- ✓ Operational cords for 7 years from purchase date.
- ✓ Motorized components for 2 years from purchase date.
- ✓ All flair21 fabrics—except Décor 54 and those with natural fibers—are guaranteed not to shrink, stretch or fade during the first five years from the purchase date.
- ✓ Repairs and replacements will be made with like or similar parts or products.

NOT COVERED BY A LIMITED LIFETIME WARRANTY

- ✗ Any conditions caused by normal wear and tear (including but not limited to exposure to the sun).
- ✗ Alterations, abuse, misuse or accidents (including but not limited to wind, water/moisture damage) to the flair21 product.
- ✗ Failure to follow flair21 instructions regarding installation, measurements, cleaning or maintenance.
- ✗ Shipping charges; cost of removal and reinstallation.
- ✗ Due to the characteristics of natural fibers, fabrics such as (but not limited to) linens, silks and cottons do not carry the same 5-year guarantee against shrinking, stretching and/or fading.

FLAIR21 RESERVES THE RIGHT TO REPAIR PRODUCTS COVERED UNDER WARRANTIES RATHER THAN TO REPLACE THE PRODUCT.

To Acquire Warranty Service

Contact your original retail dealer for warranty assistance, or visit www.flair21.com to find the closest dealer.

Note: In no event shall flair21 be liable or responsible for incidental or consequential damages or for any other indirect damage, loss, cost, or expense. Some states do not allow the exclusion or limitation of incidental or consequential damages, so the above exclusion or limitation may not apply to you. This warranty gives you specific legal rights, and you may have other rights, which vary from state to state.

Different warranty periods and terms apply for commercial products and applications.

flair
21

RETAIL CHART PRICING