

**CONTRACT DOCUMENTS**  
**FOR**  
**THE TOWN OF WINDSOR LOCKS**  
**UTILITY RECONSTRUCTION PROJECT**  
**ON**  
**COOLIDGE STREET & TAFT LANE**

JUNE 2019

Prepared For:

Town of Windsor Locks  
50 Church Street  
Windsor Locks, Connecticut 06069



**ANCHOR**  
ENGINEERING SERVICES, INC.

41 Sequin Drive  
Glastonbury, CT 06033  
T: 860.633.8770  
F: 860.633.5971



## TABLE OF CONTENTS

SECTION	TAB
Invitation to Bid .....	A
Instructions to Bidders .....	B
Forms.....	C
Bid Proposal	
Non-Collusion Affidavit of Bidder	
Qualifications Statement	
Agreement	
Construction Performance Bond	
Construction Payment Bond	
General Conditions.....	D
Supplementary Conditions .....	E
Special Provisions.....	F
Technical Specifications .....	G
Plans.....	H



# TAB A

Invitation to Bid



## INVITATION TO BID

The Town of Windsor Locks, CT is soliciting sealed bids for the site and utility work for the repair of two (2) existing roads (Coolidge Street & Taft Lane) located within the town.

This projects generally consists of all necessary work to complete roadway improvements as described on the Contract Plans and Specification. Improvements typically will include saw-cutting existing bituminous concrete pavement, replacement of sanitary sewer piping, and other miscellaneous work as shown on the plans or directed by the Owner.

Sealed bids will be received by the Public Works Department, Town of Windsor Locks, 6 Stanton Road, Windsor Locks CT 06096, until 2:00 PM prevailing time on **June 19, 2019**, when they will be opened publically and read aloud.

Bid security in the form of a surety bond, certified or bank check, or a letter of credit, payable to the Town of Windsor Locks is required in the sum of 5 percent (5%) of the base Bid. Bid security shall be subject to the condition provided in the Instructions to Bidders. Upon award of the contract, the successful bidder must furnish a Performance Bond and a Payment Bond equal to 100% of the contract price, in accordance with the Contract Documents. All bonds must be from sureties registered in the State of Connecticut.

No Bidder may withdraw his bid for a period of sixty (60) days after the date of bid opening.

The Town of Windsor Locks reserves the right to accept or reject any or all bids or options, to waive any technicality in any bid or part thereof, and to accept any bid deemed to be in the best interest of the Town of Windsor Locks.

---

Philip Sissick – Public Works Director  
Town of Windsor Locks, Connecticut





## **TAB B**

Instructions to Bidders



## INSTRUCTIONS TO BIDDERS

### 1. PROJECT DESCRIPTION:

The Town of Windsor Locks, CT is soliciting sealed bids for the site and utility work for the repair of two (2) existing roads (Coolidge Street & Taft Lane) located within the town.

This projects generally consists of all necessary work to complete roadway improvements as described on the Contract Plans and Specification. Improvements typically will include saw-cutting existing bituminous concrete pavement, replacement of sanitary sewer piping, and other miscellaneous work as shown on the plans or directed by the Owner.

### 2. GENERAL:

Sealed bids will be received by the Public Works Department, Town of Windsor Locks, 6 Stanton Road, Windsor Locks CT 06096, until 2:00 PM prevailing time on **June 19, 2019**. Bids received after the bid opening will be returned unopened.

All questions from prospective bidders must be submitted to the Anchor Engineering via fax (860-633-5971) or email ([mbrown@anchorengr.com](mailto:mbrown@anchorengr.com)) no later than 7 days prior to the bid opening. Questions after this time will not be responded to.

### 3. CONTRACT DOCUMENTS:

These Contract Documents include a complete set of proposal forms which are not to be detached from the Contract Documents, filled out or executed. For the convenience of the bidders, separate copies of bid forms are furnished for that purpose.

### 4. BIDS:

Bids shall be enclosed in a sealed envelope clearly marked "**SEALED BID – TOWN OF WINDSOR LOCKS - COOLIDGE STREET & TAFT LANE**" along with the name of bidder organization, date and time of bid opening in order to guard against premature opening of the bid.

All bids must be submitted on forms supplied by the Owner and shall be subject to all requirements of the Contract Documents, including "Instruction to Bidders". All bids must be regular in every respect; no interlineations, ditto marks, excisions or special conditions shall be made or included in the bid form by the bidder organization.

The Owner may consider as irregular any bid on which there are any omissions, alterations of form, additions not called for, conditional or alternate bids, or irregularities of any kind and, at its option, may reject same. The blank spaces in the bid must be filled in correctly where indicated for each and every item for which a quantity is given typed or printed in ink. If any price is omitted, the bid may be rejected. The Bidder shall sign his bid correctly. If the bid is made by an individual, his name and post office address must be shown. If made by a firm, partnership, or by a corporation, the bid must be signed by an official of the firm, partnership, or corporation

authorized to sign contracts, and also must show the post office address of the firm, partnership or corporation.

A Non-Collusion Affidavit shall be completed and returned with the submitted bid. More than one bid from an individual, a firm or partnership, a corporation or association under the same or different names will not be considered. Reasonable ground for believing that any Bidder is interested in more than one bid for the work contemplated will cause the rejection of all bids in which such Bidder is interested. Bids in which the prices are obviously unbalanced may be rejected.

#### **5. ADDENDA & INTERPRETATIONS:**

Any request from a prospective bidder for interpretation of meaning of Contract Documents shall be made in writing to the office of Anchor Engineering Services, Inc., 41 Sequin Drive, Glastonbury, Connecticut 06033, and to be given consideration must be received at least seven (7) days prior to date fixed for opening of bids. Interpretations will be made in the form of written Addenda to Contract Documents, which Addenda shall become a part of the Contract. Such requests may be sent via facsimile to the office of Anchor Engineering Services, Inc. at (860) 633-5971. Not later than three (3) days prior to date fixed for opening of bids, Addenda will be mailed or delivered to all parties recorded as having obtained Contract Documents. It is the responsibility of the Bidder to verify that all Addenda have been received and incorporated into the submitted bid. Failure of any Bidder to receive any such Addenda shall not relieve Bidder from any obligations under his bid as submitted. Only questions answered by formal written Addenda will be binding. Oral and other interpretations or clarifications will be without legal effect.

#### **6. SITE CONDITIONS:**

All information on the Drawings or in the contract Documents relating to subsurface conditions, utilities, and other structures is from best sources available at present to the Owner. All such information and drawings of existing construction are furnished only for the information and convenience of bidders.

At the date fixed for opening of bids, it will be presumed that each Bidder has made an examination of location and site of work to be done under Contract; has satisfied himself as to actual conditions, requirements and quantities of work; has considered federal, state and local laws and regulations that may affect cost, progress, performance or furnishing the Work; and has read and become thoroughly familiar with Contract Documents including Contract Drawings, Specifications, Addenda, and documents referenced therein.

The Owner and the Engineer assume no responsibility whatsoever with respect to ascertaining for the Contractor any facts concerning physical characteristics at the site of the project.

#### **7. BIDDER'S QUALIFICATIONS:**

The Owner shall make such investigation as deemed necessary to determine the ability of the Bidder to discharge his Contract. After bid opening, Bidder shall be prepared to furnish the Owner with all written evidence as may be required for this purpose (e.g., financial data, previous experience, present commitments) within five (5) days after Owner requests such evidence. Each

bid must contain evidence of Bidder's qualification to do business in the State of Connecticut or covenant to obtain such qualification prior to award of the contract.

Bids received from Bidders who have previously failed to complete contracts within the time required, or who have previously performed similar work in an unsatisfactory manner, may be rejected. A bid may be rejected if the Bidder cannot show that he has the necessary capital and experience, and owns, controls, or can procure the necessary plant to commence and complete the work at the rate or time specified, and that he is not already obligated for the performance of other work which would delay the commencement, prosecution, or completion of the work.

**8. MODIFICATION:**

Any Bidder may modify his bid at any time prior to the scheduled closing time for receipt of bids, by submitting an appropriate document duly executed in a manner that bid must be executed and delivered to the place where bids are to be submitted. After opening of bids, no Bidder may withdraw his bid for a period of sixty (60) days. Owner may, in its sole discretion, release any bid prior to that date.

**9. REJECTION OF BIDS:**

The Owner also reserves the right to reject any or all bids, for any reason it deems advisable, and to award Contract to any of the Bidder organizations, regardless of amount of bid.

**10. TIME OF COMPLETION & LIQUIDATED DAMAGES:**

The Bidder must agree to fully complete all work within the number of consecutive calendar days of the issuance of the Notice to Proceed set forth in the Agreement. The Bidder must agree also to pay as liquidated damages the sum set forth in the Agreement for each consecutive calendar day thereafter.

**11. AWARD OF CONTRACTS:**

If the Contract is awarded, Owner will give successful bidder a Notice of Award within sixty (60) days after the day of bid opening. The successful bidder shall then execute and deliver to the Owner, within ten (10) days after notification of the award, three (3) executed Agreements in the form provided by the Owner. If the successful bidder fails to comply with the requirements of these documents within ten (10) days of receiving said Notice, that bidder shall forfeit bid security and, at the option of the Owner, the Award may become null and void. The Owner may then proceed to Award the Contract to another of the Bidders.

**12. BID SECURITY:**

Each bid must be accompanied by a surety bond, certified or bank check, or a letter of credit, in the amount of 5% of the total of the bid. Bid security of the successful Bidder will be retained until such Bidder has executed the Agreement, furnished the required contract security and met the other conditions of the Notice of Award, whereupon the bid security will be returned. The bid security of other Bidders whom Owner believes to have a reasonable chance of receiving the award may be retained by Owner until the earlier of the seventh day after the Effective Date of the

Agreement or the sixty-first day after bid opening, whereupon the bid security furnished by such Bidders will be returned. Bid security with bids which are not competitive will be returned within seven (7) days of bid opening.

**13. SCHEDULE OF VALUES:**

The apparent successful Bidder must submit, prior to the execution of an Agreement, a preliminary schedule of values for all of the Work. The preliminary schedule of values must be submitted after Bidding by the apparent low Bidder, and the schedule of values must be deemed acceptable by the Engineer, before the Agreement is executed.

**14. SECURITY FOR FAITHFUL PERFORMANCE:**

In addition to the Agreement, the successful Bidder shall also provide, within the time stipulated, a Construction Performance Bond by a company satisfactory to the Owner in an amount equal to One Hundred Percent (100%) of Estimated Total Contract Price recorded in the bid section of the Contract as executed, and a Construction Payment Bond in like amount will be required from the successful Bidder for faithful performance of the Contract.

# TAB C

## Forms

Bid Proposal  
Non-Collusion Affidavit of Bidder  
Qualifications Statement  
Agreement  
Construction Performance Bond  
Construction Payment Bond





## BID PROPOSAL

### PROJECT IDENTIFICATION:

Coolidge Street & Taft Lane  
Windsor Locks, Connecticut 06096

### THIS BID IS SUBMITTED TO:

Town of Windsor Locks Public Works Department  
6 Stanton Road  
Windsor Locks, Connecticut 06096  
Attention: Mr. Philip Sissick, Public Works Director

The Undersigned Bidder proposes and agrees, if this Bid is accepted, to enter into an agreement with Owner in the form included in the Contract Documents to perform and furnish all Work as specified or indicated in the Contract Documents for the Bid Price and within the Bid Times indicated in this Bid and in accordance with the other terms and conditions of the Contract Documents.

Bidder accepts all terms and conditions of the Invitation to Bid and Instructions to Bidders, including without limitation those dealing with the disposition of Bid security. This Bid will remain subject to acceptance for sixty (60) days after the day of Bid opening. Bidder will sign and deliver the required number of counterparts of the Agreement with the Bonds and other documents required by the Bidding Requirements within ten (10) days after the date of Owner's Notice of Award.

In submitting this Bid, Bidder represents, as more fully set forth in the Agreement, that:

1. Bidder has examined and carefully studied the Bidding Documents and the following Addenda receipt all of which is hereby acknowledged (List Addenda by Addendum Number and Date):

---

---

---

2. Bidder has visited the site and become familiar with and is satisfied as to the general, local and site conditions that may affect cost, progress, performance and furnishing of the Work.
3. Bidder is familiar with and is satisfied as to all federal, state and local Laws and regulations that may affect cost, progress, performance and furnishing of the Work.
4. Bidder has carefully studied all reports and explorations and tests of subsurface conditions at or contiguous to the site and all drawings of physical conditions in or relating to existing surface or subsurface structures at or contiguous to the site (except Underground Facilities) which have been identified in the Supplementary Conditions. Bidder acknowledges that Owner and Engineer do not assume responsibility for the accuracy or completeness of information and data shown or indicated in the Bidding Documents with respect to Underground Utilities at or contiguous to the site. Bidder has obtained and carefully studied (or assumes responsibility for having done so) all such additional or supplementary examinations, investigations, explorations, tests, studies and data concerning conditions (surface, subsurface, Underground Facilities) at or

contiguous to the site or otherwise which may affect cost, progress, performance or furnishing of the Work or which relate to any aspect of the means, methods, techniques, sequences and procedures of construction to be employed by Bidder and safety precautions and programs related thereto. Bidder does not consider that any additional examinations, investigations, explorations, tests, studies or data are necessary for the determination of the Bid for performance and furnishing of the Work in accordance with the times, price and other terms and conditions of the Contract Documents.

5. Bidder is aware of the general nature of Work to be performed by Owner and others at the site that relates to Work for which this Bid is submitted as indicated in the Contract Documents.
6. Bidder has correlated the information known to Bidder, information and observations obtained from visits to the site, reports and drawings identified in the Contract Documents and all additional examinations, investigations, explorations, tests, studies and data with the Contract Documents.
7. Bidder has given Engineer written notice of all conflicts, errors, ambiguities or discrepancies that Bidder has discovered in the Contract Documents and the written resolution thereof by Engineer is acceptable to Bidder, and the Contract Documents are generally sufficient to indicate and convey understanding of all terms and conditions for performing and furnishing the Work for which this Bid is submitted.
8. This Bid is genuine and not made in the interest of or on behalf of any undisclosed person, firm or corporation and is not submitted in conformity with any agreement or rules of any group, association, organization or corporation; Bidder has not directly or indirectly induced or solicited any other Bidder to submit a false or sham Bid; Bidder has not solicited or induced any person, firm or corporation to refrain from bidding; and Bidder has not sought by collusion to obtain for itself any advantage over any other Bidder or over Owner.
9. Bidder is to write in the "Schedule of Prices" portion of this document his unit prices Bid (or lump sum price when unit price is not applicable) in words and in figures in the blank spaces provided under SCHEDULE OF PRICES, and write his total amount for the item under AMOUNT.

The Bidder is advised that the description below is only a summary. The unit price or lump sum bid shall include all of the items as specified in detail in the contract documents. Bidder will complete the Work in accordance with the Contract Documents for the following price(s):

**A. BASE BID –SITE/UTILITY WORK - LUMP SUM**

Bidder will complete all work described in the Contract Documents and Plans associated with Coolidge Street & Taft Lane in accordance with the plans and specifications for the following lump sum price:

---

Dollars (*in words*)

\$ \_\_\_\_\_  
(*in numbers*)

The undersigned affirms that the above lump sum price represents the entire cost per plans, specifications, addenda, including all labor, materials, tools, equipment, overhead, profit and that no claim will be made on account of any increase in wage scales, material prices, delivery delays, taxes, insurance, cost indexes or any other rates affecting the construction industry or this project.

- 10. Bidder agrees that the Work will be substantially completed and completed and ready for final payment in accordance with Article 14 of the General Conditions on or before the dates or within the number of calendar days indicated in the Agreement.
- 11. Bidder accepts the provisions of the Agreement as to liquidate damages in the event of failure to complete the Work within the times specified in the Agreement.
- 12. The following documents are attached to and made a part of this Bid:

Required Bid Security in the form of \_\_\_\_\_

- 13. Communications concerning this Bid shall be addressed to the address of Bidder below.
- 14. Terms used in this Bid which are defined in the General Conditions or Instructions to Bidders will have the same meanings indicated in the General Conditions or Instructions to Bidders.

SUBMITTED on: \_\_\_\_\_, 2019      *(Seal – if Bid by Corporation)*

By: \_\_\_\_\_ Title: \_\_\_\_\_

Bidder: \_\_\_\_\_

Address: \_\_\_\_\_

\_\_\_\_\_  
\_\_\_\_\_

SEAL – if Bid is by a Corporation

The undersigned affirms that the above lump sum price represents the entire cost per plans, specifications, addenda, including all labor, materials, tools, equipment, overhead, profit and that no claim will be made on account of any increase in wage scales, material prices, delivery delays, taxes, insurance, cost indexes or any other rates affecting the construction industry or this project.





### BIDDER'S QUALIFICATION STATEMENT

All bidders are required to complete this form properly and submit it with their proposal. Failure of a bidder to answer any question or provide required information in sufficient detail or providing incorrect or false information may result in bid rejection. *(Use back of sheet if necessary for add'l space)*

1. State the exact organization name, address, telephone: \_\_\_\_\_

---

---

---

---

2. State the type of organization (Corporation, Partnership, Sole Proprietorship, Other):

---

3. State the number of years this organization has been in business under present name: \_\_\_\_\_

4. State the number of years this organization has been in business as a General Contractor: \_\_\_\_\_

5. If organization has not always been a General Contractor, list the trade(s) customarily performed prior to becoming a General Contractor:

---

---

---

---

6. If organization has not always been under present name, list all other names by which the organization has been known and associated length of time:

---

---

---

---

7. List all licenses (description and number) held by the organization:

---

---

---

---

8. Has the organization ever failed to complete a contract, or has any officer or partner of the organization ever been an officer or partner of another organization that failed to complete a contract (Yes/No)? If yes, indicate the circumstances leading to the project failure and the name of the company which provided the bonding for the failed contract(s):

---

---

---

---

9. List all legal or administrative proceedings currently pending or concluded within the last five years which relate to procurement or performance of any public or private construction contract:

---

---

---

---

10. List all Occupational Safety and Health Act (OSHA) violations cited within the last five years:

---

---

---

---

---



11. List all present commitments or obligations that may delay the work:

---

---

---

---

---

12. List all major tasks to be completed on the job as well as who will be performing each task (i.e. your company or a subcontractor), if a subcontractor will be utilized, please identify by name:

---

---

---

---

---

13. List five projects and associated references contact information for similar projects performed demonstrating ability to complete job within the time required and within the established budget. Preference is for projects of similar size and scope to this project, with minimum contract value of \$400,000. Provide project name, address, original contract amount, final contract amount, date completed, owner & reference contact:

---

---

---

---

---

---

---

---

---

---

---

---

14. List previous relevant construction experience within the past 2 years:

---

---

---

---

---

Dated at \_\_\_\_\_

this \_\_\_\_\_ day of \_\_\_\_\_, 2019.

Name of Organization:

---

Signature: \_\_\_\_\_

(Print Name): \_\_\_\_\_

Title: \_\_\_\_\_

Notary Statement:

Mr./Mrs./Ms. \_\_\_\_\_ being duly sworn  
deposes and says that he/she is the \_\_\_\_\_(Position/Title) of  
\_\_\_\_\_(Organization Name),  
and that all of the answers and statements contained therein are true and accurate.

Subscribed and sworn before me this \_\_\_\_\_ day of \_\_\_\_\_, 2019.

Notary Public: \_\_\_\_\_

My Commission expires: \_\_\_\_\_, \_\_\_\_\_



## AGREEMENT

### BETWEEN OWNER AND CONTRACTOR ON THE BASIS OF A STIPULATED PRICE

THIS AGREEMENT is dated as of the \_\_\_\_\_ day of \_\_\_\_\_ in the year \_\_\_\_\_ by and between the Town of Windsor Locks (hereinafter called OWNER) and \_\_\_\_\_ (hereinafter called CONTRACTOR).

OWNER and CONTRACTOR, in consideration of the mutual covenants hereinafter set forth, agree as follows:

#### Article 1. WORK

CONTRACTOR shall complete all Work as specified or indicated in the Contract Documents. The Work is generally described in Section 01 11 00 of the Technical Specifications.

#### Article 2. ENGINEER

The Project has been designed by:

Anchor Engineering Services, Inc.  
41 Sequin Drive  
Glastonbury, Connecticut 06033  
Phone: (860) 633-8770

who is hereinafter called ENGINEER and who is to act as OWNER's representative from time to time, assume some duties and responsibilities and have the rights and authority assigned to ENGINEER in the Contract Documents in connection with completion of the Work in accordance with the Contract Documents. OWNER will perform most of the duties associated with processing applications for payments in lieu of ENGINEER.

#### Article 3. CONTRACT TIMES

- 3.1 The Work will be substantially completed within thirty (30) consecutive calendar days of issuance of Notice to Proceed as provided in paragraph 2.03 of the General Conditions and as modified by the Supplementary Conditions
- 3.2 *Liquidated Damages.* OWNER and CONTRACTOR recognize that time is of the essence of this Agreement and that OWNER may suffer financial loss if the Work is not completed within the times specified in paragraph 3.1 above, plus any extensions thereof allowed in accordance with Article 12 of the General Conditions. They also recognize the delays, expense and difficulties involved in proving the actual loss suffered by OWNER if the Work is not completed on time. Accordingly, instead of requiring any such proof, OWNER and CONTRACTOR agree that as liquidated damages for delay (but not as a penalty) CONTRACTOR shall pay OWNER five hundred dollars (\$500.00) for each calendar day that expires after the time specified in paragraph 3.1 for Substantial Completion until the Work is substantially complete. After Substantial Completion, if

CONTRACTOR shall neglect, refuse or fail to complete the remaining Work within the time specified in paragraph 3.1 for completion and readiness for final payment or any proper extension thereof granted by OWNER, CONTRACTOR shall pay OWNER five hundred dollars (\$500.00) for each calendar day that expires after the time specified in paragraph 3.1 for completion and readiness for final payment.

#### Article 4. CONTRACT PRICE

OWNER shall pay CONTRACTOR for completion of the Work in accordance with the Contract Documents an amount in current funds equal to the sum of the amounts determined pursuant to paragraphs 4.1 and 4.2 below:

- 4.1 In accordance with the Lump Sum Price and Unit Price Adjustments contained in the Contractor's Bid Proposal (BP-1 thru BP-4)
- 4.2 The total estimated base price based on estimated quantities is  
  
\$ \_\_\_\_\_; Final payment will be based on actual quantities:

#### Article 5. PAYMENT PROCEDURES

CONTRACTOR shall submit Applications for Payment in accordance with Article 14 of the General Conditions. Applications for Payment will be processed by OWNER or ENGINEER as provided in the General Conditions and Supplementary Conditions.

- 5.1 *Progress Payments; Retainage.* OWNER shall make progress payments on account of the Contract Price on the basis of CONTRACTOR's Applications for Payment as recommended by the ENGINEER, each month during construction as provided in paragraphs 5.1.1 and 5.1.2. below. All such payments will be measured by the schedule of values established in paragraph 2.07 of the General Conditions (and in the case of Unit Price Work based on the number of units completed), or, in the event there is no schedule of values, as provided in the General Requirements.
  - 5.1.1 Prior to Substantial Completion, progress payments will be made in an amount equal to the percentage indicated below, but, in each case, less the aggregate of payments previously made and less such amounts as ENGINEER shall determine, or OWNER may withhold, in accordance with paragraph 14.02 of the General Conditions.  
  
90% of Work completed (with the balance being retainage).  
  
90% (with the balance being retainage) of materials and equipment not incorporated in the Work (but delivered, suitably stored and accompanied by documentation satisfactory to OWNER as provided in paragraph 14.02 of the General Conditions).
  - 5.1.2 Upon Substantial Completion, in an amount sufficient to increase total payments to CONTRACTOR to 98% of the Contract Price (with the balance being retainage), less such amounts as ENGINEER shall determine, or OWNER may withhold, in accordance with paragraph 14.02 of the General Conditions.

- 5.2 *Final Payment.* At the end of the One Year Correction Period, the CONTRACTOR shall submit to ENGINEER an Application for Payment of the retainage in accordance with paragraph 14.07 of the General Conditions.

## **Article 6. INTEREST**

All moneys not paid when due as provided in Article 14 of the General Conditions shall bear interest at the maximum rate allowed by law at the place of the project.

## **Article 7. CONTRACTOR'S REPRESENTATIONS**

In order to induce OWNER to enter into this Agreement, CONTRACTOR makes the following representations:

- 7.1 CONTRACTOR has examined and carefully studied the Contract Documents (including the Addenda listed in paragraph 8) and the other related data identified in the Proposal Documents including "technical data".
- 7.2 CONTRACTOR has visited the site and become familiar with and is satisfied as to the general, local and site conditions that may affect cost, progress, performance or furnishing of the Work.
- 7.3 CONTRACTOR is familiar with and is satisfied as to all federal, state and local Laws and Regulations that may affect cost, progress, performance and furnishing of the Work.
- 7.4 CONTRACTOR has carefully studied all reports of explorations and tests of subsurface conditions at or contiguous to the site and all drawings of physical conditions in or relating to existing surface or subsurface structures at or contiguous to the site (except Underground Facilities) which have been identified in the Supplementary Conditions as provided in paragraph 4.0.2 of the General Conditions. CONTRACTOR accepts the determination set forth in paragraph 4.0.2 of the Supplementary Conditions of the extent of the "technical data" contained in such reports and drawings upon which CONTRACTOR is entitled to rely as provided in paragraph 4.0.2 of the General Conditions. CONTRACTOR acknowledges that such reports and drawings are not Contract Documents and may not be complete for CONTRACTOR's purposes. CONTRACTOR acknowledges that OWNER and ENGINEER do not assume responsibility for the accuracy or completeness of information and data shown or indicated in the Contract Documents with respect to Underground Facilities at or contiguous to the site. CONTRACTOR has obtained and carefully studied (or assumes responsibility for having done so) all such additional supplementary examinations, investigations, explorations, tests, studies and data concerning conditions (surface, subsurface and Underground Facilities) at or contiguous to the site or otherwise which may affect cost, progress, performance or furnishing of the Work or which relate to any aspect of the means, methods, techniques, sequences and procedures of construction to be employed by CONTRACTOR and safety precautions and programs incident thereto. CONTRACTOR does not consider that any additional examinations, investigations, explorations, tests, studies or data are necessary for the performance and furnishing of the

Work at the Contract Price, within the Contract Times and in accordance with the other terms and conditions of the Contract Documents.

- 7.5 CONTRACTOR is aware of the general nature of work to be performed by OWNER and others at the site that relates to the Work as indicated in the Contract Documents.
- 7.6 CONTRACTOR has correlated the information known to CONTRACTOR, information and observations obtained from visits to the site, reports and drawings identified in the Contract Documents and all additional examinations, investigations, explorations, tests, studies and data with the Contract Documents.
- 7.7 CONTRACTOR has given ENGINEER written notice of all conflicts, errors, ambiguities or discrepancies that CONTRACTOR has discovered in the Contract Documents and the written solution thereof by ENGINEER is acceptable to CONTRACTOR, and the Contract Documents are generally sufficient to indicate and convey understanding of all terms and conditions for performance and furnishing of the Work.

#### **Article 8. CONTRACT DOCUMENTS**

The Contract Documents which comprise the entire agreement between OWNER and CONTRACTOR concerning the Work consist of the following:

- 8.1 This Agreement (pages A-1 to A-6, inclusive).
- 8.2 Exhibits to this Agreement (Exhibits A, B, C, D, E, ...).
  - 8.2a Exhibit A – Contractor’s Certificate of Insurance
  - 8.2b Exhibit B – Contractor’s Performance Bond & Payment Bond.
  - 8.2c Exhibit C – Contractor’s Bid
  - 8.2d Exhibit D – Bid Addenda (if any....)
  - 8.2e Exhibit E – Original Contract Bid Documents.
- 8.3 The following which may be delivered or issued after the Effective Date of the Agreement and are not attached hereto: All Written Amendments and other documents amending, modifying or supplementing the Contract Documents pursuant to paragraph 3.0.4 of the General Conditions.

The documents listed in paragraphs 8.2 et seq. above are attached to this Agreement (except as expressly noted otherwise above).

There are no Contract Documents other than those listed in this Article 8. The Contract Documents may only be amended, modified, or supplemented as provided in paragraph 3.0.4 of the General Conditions.



## Article 9. MISCELLANEOUS

- 9.1 Terms used in this Agreement which are defined in Article 1 of the General Conditions will have the meanings indicated in the General Conditions.
- 9.2 No assignment by a party hereto of any rights under or interests in the Contract Documents will be binding on another party hereto without the written consent of the party sought to be bound; and, specifically but without limitation, moneys that may become due and moneys that are due may not be assigned without such consent (except to the extent that the effect of this restriction may be limited by law), and unless specifically stated to the contrary in any written consent to an assignment no assignment will release or discharge the assignor from any duty or responsibility under the Contract Documents.
- 9.3 OWNER and CONTRACTOR each binds itself, its partners, successors, assigns and legal representatives to the other party hereto, its partners, successors, assigns and legal representatives in respect to all covenants, agreements and obligations contained in the Contract Documents.
- 9.4 Any provision or part of the Contract Documents held to be void or unenforceable under any Law or Regulation shall be deemed stricken, and all remaining provisions shall continue to be valid and binding upon OWNER and CONTRACTOR, who agree that the Contract Documents shall be reformed to replace such stricken provision or part thereof with a valid and enforceable provision that comes as close as possible to expressing the intention of the stricken provision.

IN WITNESS WHEREOF, OWNER and CONTRACTOR have signed this Agreement, in triplicate. One counterpart each has been delivered to OWNER, CONTRACTOR and ENGINEER. All portions of the Contract Documents have been signed, initialed or identified by OWNER and CONTRACTOR or identified by OWNER and CONTRACTOR or identified by ENGINEER on their behalf.

This Agreement will be effective on \_\_\_\_\_, 2019, (which is the Effective Date of the Agreement).

OWNER:

CONTRACTOR:

Town of Windsor Locks

\_\_\_\_\_

By: \_\_\_\_\_

By: \_\_\_\_\_

[CORPORATE SEAL]

[CORPORATE SEAL]

Attest \_\_\_\_\_

Attest \_\_\_\_\_

Address for giving notices:

Address for giving notices:

\_\_\_\_\_  
\_\_\_\_\_  
\_\_\_\_\_

\_\_\_\_\_  
\_\_\_\_\_  
\_\_\_\_\_

(If OWNER is a public body, attach evidence of authority to sign and resolution or other documents authorizing execution of Agreement.)

License No. \_\_\_\_\_

Agent for service of process: \_\_\_\_\_

\_\_\_\_\_

(If CONTRACTOR is a corporation, attach evidence of authority to sign.)

# PERFORMANCE BOND

Any singular reference to Contractor, Surety, Owner, or other party shall be considered plural where applicable.

---

CONTRACTOR (Name and Address):

SURETY (Name and Address of Principal Place of Business):

OWNER (Name and Address):

## CONTRACT

Date:

Amount:

Description (Name and Location):

## BOND

Bond Number:

Date (Not earlier than Contract Date):

Amount:

Modifications to this Bond Form:

Surety and Contractor, intending to be legally bound hereby, subject to the terms printed on the reverse side hereof, do each cause this Performance Bond to be duly executed on its behalf by its authorized officer, agent, or representative.

### CONTRACTOR AS PRINCIPAL

Company:

Signature: \_\_\_\_\_ (Seal)

Name and Title:

### SURETY

\_\_\_\_\_  
(Seal)

Surety's Name and Corporate Seal

By: \_\_\_\_\_

Signature and Title

(Attach Power of Attorney)

(Space is provided below for signatures of additional parties, if required.)

Attest: \_\_\_\_\_

Signature and Title

### CONTRACTOR AS PRINCIPAL

Company:

Signature: \_\_\_\_\_ (Seal)

Name and Title:

### SURETY

\_\_\_\_\_  
(Seal)

Surety's Name and Corporate Seal

By: \_\_\_\_\_

Signature and Title

(Attach Power of Attorney)

Attest: \_\_\_\_\_

Signature and Title:

EJCDC No. C-610 (2002 Edition)

Originally prepared through the joint efforts of the Surety Association of America, Engineers Joint Contract Documents Committee, the Associated General Contractors of America, and the American Institute of Architects.

1. Contractor and Surety, jointly and severally, bind themselves, their heirs, executors, administrators, successors, and assigns to Owner for the performance of the Contract, which is incorporated herein by reference.

2. If Contractor performs the Contract, Surety and Contractor have no obligation under this Bond, except to participate in conferences as provided in Paragraph 3.1.

3. If there is no Owner Default, Surety's obligation under this Bond shall arise after:

3.1. Owner has notified Contractor and Surety, at the addresses described in Paragraph 10 below, that Owner is considering declaring a Contractor Default and has requested and attempted to arrange a conference with Contractor and Surety to be held not later than 15 days after receipt of such notice to discuss methods of performing the Contract. If Owner, Contractor and Surety agree, Contractor shall be allowed a reasonable time to perform the Contract, but such an agreement shall not waive Owner's right, if any, subsequently to declare a Contractor Default; and

3.2. Owner has declared a Contractor Default and formally terminated Contractor's right to complete the Contract. Such Contractor Default shall not be declared earlier than 20 days after Contractor and Surety have received notice as provided in Paragraph 3.1; and

3.3. Owner has agreed to pay the Balance of the Contract Price to:

1. Surety in accordance with the terms of the Contract;
2. Another contractor selected pursuant to Paragraph 4.3 to perform the Contract.

4. When Owner has satisfied the conditions of Paragraph 3, Surety shall promptly and at Surety's expense take one of the following actions:

4.1. Arrange for Contractor, with consent of Owner, to perform and complete the Contract; or

4.2. Undertake to perform and complete the Contract itself, through its agents or through independent contractors; or

4.3. Obtain bids or negotiated proposals from qualified contractors acceptable to Owner for a contract for performance and completion of the Contract, arrange for a contract to be prepared for execution by Owner and Contractor selected with Owner's concurrence, to be secured with performance and payment bonds executed by a qualified surety equivalent to the bonds issued on the Contract, and pay to Owner the amount of damages as described in Paragraph 6 in excess of the Balance of the Contract Price incurred by Owner resulting from Contractor Default; or

4.4. Waive its right to perform and complete, arrange for completion, or obtain a new contractor and with reasonable promptness under the circumstances:

1. After investigation, determine the amount for which it may be liable to Owner and, as soon as practicable after the amount is determined, tender payment therefor to Owner; or
2. Deny liability in whole or in part and notify Owner citing reasons therefor.

5. If Surety does not proceed as provided in Paragraph 4 with reasonable promptness, Surety shall be deemed to be in default on this Bond 15 days after receipt of an additional written notice from Owner to Surety demanding that Surety perform its obligations under this Bond, and Owner shall be entitled to enforce any remedy available to Owner. If Surety proceeds as provided in Paragraph 4.4, and Owner refuses the payment tendered or Surety has denied liability, in whole or in part, without further notice Owner shall be entitled to enforce any remedy available to Owner.

6. After Owner has terminated Contractor's right to complete the Contract, and if Surety elects to act under Paragraph 4.1, 4.2, or 4.3 above, then the responsibilities of Surety to Owner shall not be greater than those of Contractor under the Contract, and the responsibilities of Owner to Surety shall not be greater than those of Owner under the Contract. To a limit of the amount of this Bond, but subject to commitment by Owner of the Balance of the Contract Price to mitigation of costs and damages on the Contract, Surety is obligated without duplication for:

6.1. The responsibilities of Contractor for correction of defective Work and completion of the Contract;

6.2. Additional legal, design professional, and delay costs resulting from Contractor's Default, and resulting from the actions or failure to act of Surety under Paragraph 4; and

6.3. Liquidated damages, or if no liquidated damages are specified in the Contract, actual damages caused by delayed performance or non-performance of Contractor.

7. Surety shall not be liable to Owner or others for obligations of Contractor that are unrelated to the Contract, and the Balance of the Contract Price shall not be reduced or set off on account of any such unrelated obligations. No right of action shall accrue on this Bond to any person or entity other than Owner or its heirs, executors, administrators, or successors.

8. Surety hereby waives notice of any change, including changes of time, to Contract or to related subcontracts, purchase orders, and other obligations.

9. Any proceeding, legal or equitable, under this Bond may be instituted in any court of competent jurisdiction in the location in which the Work or part of the Work is located and shall be instituted within two years after Contractor Default or within two years after Contractor ceased working or within two years after Surety refuses or fails to perform its obligations under this Bond, whichever occurs first. If the provisions of this paragraph are void or prohibited by law, the minimum period of limitation available to sureties as a defense in the jurisdiction of the suit shall be applicable.

10. Notice to Surety, Owner, or Contractor shall be mailed or delivered to the address shown on the signature page.

11. When this Bond has been furnished to comply with a statutory requirement in the location where the Contract was to be performed, any provision in this Bond conflicting with said statutory requirement shall be deemed deleted herefrom and provisions conforming to such statutory requirement shall be deemed incorporated herein. The intent is that this Bond shall be construed as a statutory bond and not as a common law bond.

12. Definitions.

12.1 Balance of the Contract Price: The total amount payable by Owner to Contractor under the Contract after all proper adjustments have been made, including allowance to Contractor of any amounts received or to be received by Owner in settlement of insurance or other Claims for damages to which Contractor is entitled, reduced by all valid and proper payments made to or on behalf of Contractor under the Contract.

12.2 Contract: The agreement between Owner and Contractor identified on the signature page, including all Contract Documents and changes thereto.

12.3 Contractor Default: Failure of Contractor, which has neither been remedied nor waived, to perform or otherwise to comply with the terms of the Contract.

12.4 Owner Default: Failure of Owner, which has neither been remedied nor waived, to pay Contractor as required by the Contract or to perform and complete or comply with the other terms thereof.

FOR INFORMATION ONLY – Name, Address and Telephone  
Surety Agency or Broker  
Owner's Representative (engineer or other party)

# PAYMENT BOND

Any singular reference to Contractor, Surety, Owner, or other party shall be considered plural where applicable.

CONTRACTOR (Name and Address):

SURETY (Name and Address of Principal Place of Business):

OWNER (Name and Address):

## CONTRACT

Date:

Amount:

Description (Name and Location):

## BOND

Bond Number:

Date (Not earlier than Contract Date):

Amount:

Modifications to this Bond Form:

Surety and Contractor, intending to be legally bound hereby, subject to the terms printed on the reverse side hereof, do each cause this Payment Bond to be duly executed on its behalf by its authorized officer, agent, or representative.

### CONTRACTOR AS PRINCIPAL

Company:

Signature: \_\_\_\_\_ (Seal)

Name and Title:

### SURETY

\_\_\_\_\_  
(Seal)

Surety's Name and Corporate Seal

By: \_\_\_\_\_

Signature and Title

(Attach Power of Attorney)

(Space is provided below for signatures of additional parties, if required.)

Attest: \_\_\_\_\_

Signature and Title

### CONTRACTOR AS PRINCIPAL

Company:

Signature: \_\_\_\_\_ (Seal)

Name and Title:

### SURETY

\_\_\_\_\_  
(Seal)

Surety's Name and Corporate Seal

By: \_\_\_\_\_

Signature and Title

(Attach Power of Attorney)

Attest: \_\_\_\_\_

Signature and Title:

EJCDC No. C-615 (2002 Edition)

Originally prepared through the joint efforts of the Surety Association of America, Engineers Joint Contract Documents Committee, the Associated General Contractors of America, the American Institute of Architects, the American Subcontractors Association, and the Associated Specialty Contractors.

1. Contractor and Surety, jointly and severally, bind themselves, their heirs, executors, administrators, successors, and assigns to Owner to pay for labor, materials, and equipment furnished by Claimants for use in the performance of the Contract, which is incorporated herein by reference.

2. With respect to Owner, this obligation shall be null and void if Contractor:

2.1. Promptly makes payment, directly or indirectly, for all sums due Claimants, and

2.2. Defends, indemnifies, and holds harmless Owner from all claims, demands, liens, or suits alleging non-payment by Contractor by any person or entity who furnished labor, materials, or equipment for use in the performance of the Contract, provided Owner has promptly notified Contractor and Surety (at the addresses described in Paragraph 12) of any claims, demands, liens, or suits and tendered defense of such claims, demands, liens, or suits to Contractor and Surety, and provided there is no Owner Default.

3. With respect to Claimants, this obligation shall be null and void if Contractor promptly makes payment, directly or indirectly, for all sums due.

4. Surety shall have no obligation to Claimants under this Bond until:

4.1. Claimants who are employed by or have a direct contract with Contractor have given notice to Surety (at the addresses described in Paragraph 12) and sent a copy, or notice thereof, to Owner, stating that a claim is being made under this Bond and, with substantial accuracy, the amount of the claim.

4.2. Claimants who do not have a direct contract with Contractor:

1. Have furnished written notice to Contractor and sent a copy, or notice thereof, to Owner, within 90 days after having last performed labor or last furnished materials or equipment included in the claim stating, with substantial accuracy, the amount of the claim and the name of the party to whom the materials or equipment were furnished or supplied, or for whom the labor was done or performed; and

2. Have either received a rejection in whole or in part from Contractor, or not received within 30 days of furnishing the above notice any communication from Contractor by which Contractor had indicated the claim will be paid directly or indirectly; and

3. Not having been paid within the above 30 days, have sent a written notice to Surety and sent a copy, or notice thereof, to Owner, stating that a claim is being made under this Bond and enclosing a copy of the previous written notice furnished to Contractor.

5. If a notice by a Claimant required by Paragraph 4 is provided by Owner to Contractor or to Surety, that is sufficient compliance.

6. When a Claimant has satisfied the conditions of Paragraph 4, the Surety shall promptly and at Surety's expense take the following actions:

6.1. Send an answer to that Claimant, with a copy to Owner, within 45 days after receipt of the claim, stating the amounts that are undisputed and the basis for challenging any amounts that are disputed.

6.2. Pay or arrange for payment of any undisputed amounts.

7. Surety's total obligation shall not exceed the amount of this Bond, and the amount of this Bond shall be credited for any payments made in good faith by Surety.

8. Amounts owed by Owner to Contractor under the Contract shall be used for the performance of the Contract and to satisfy claims, if any, under any performance bond. By Contractor furnishing and Owner accepting this Bond, they agree that all funds earned by Contractor in the performance of the Contract are dedicated to satisfy obligations of Contractor and Surety under this Bond, subject to Owner's priority to use the funds for the completion of the Work.

9. Surety shall not be liable to Owner, Claimants, or others for obligations of Contractor that are unrelated to the Contract. Owner shall not be liable for payment of any costs or expenses of any Claimant under this Bond, and shall have under this Bond no obligations to make payments to, give notices on behalf of, or otherwise have obligations to Claimants under this Bond.

10. Surety hereby waives notice of any change, including changes of time, to the Contract or to related Subcontracts, purchase orders and other obligations.

11. No suit or action shall be commenced by a Claimant under this Bond other than in a court of competent jurisdiction in the location in which the Work or part of the Work is located or after the expiration of one year from the date (1) on which the Claimant gave the notice required by Paragraph 4.1 or Paragraph 4.2.3, or (2) on which the last labor or service was performed by anyone or the last materials or equipment were furnished by anyone under the Construction Contract, whichever of (1) or (2) first occurs. If the provisions of this paragraph are void or prohibited by law, the minimum period of limitation available to sureties as a defense in the jurisdiction of the suit shall be applicable.

12. Notice to Surety, Owner, or Contractor shall be mailed or delivered to the addresses shown on the signature page. Actual receipt of notice by Surety, Owner, or Contractor, however accomplished, shall be sufficient compliance as of the date received at the address shown on the signature page.

13. When this Bond has been furnished to comply with a statutory requirement in the location where the Contract was to be performed, any provision in this Bond conflicting with said statutory requirement shall be deemed deleted herefrom and provisions conforming to such statutory requirement shall be deemed incorporated herein. The intent is that this Bond shall be construed as a statutory Bond and not as a common law bond.

14. Upon request of any person or entity appearing to be a potential beneficiary of this Bond, Contractor shall promptly furnish a copy of this Bond or shall permit a copy to be made.

#### 15. DEFINITIONS

15.1. Claimant: An individual or entity having a direct contract with Contractor, or with a first-tier subcontractor of Contractor, to furnish labor, materials, or equipment for use in the performance of the Contract. The intent of this Bond shall be to include without limitation in the terms "labor, materials or equipment" that part of water, gas, power, light, heat, oil, gasoline, telephone service, or rental equipment used in the Contract, architectural and engineering services required for performance of the Work of Contractor and Contractor's Subcontractors, and all other items for which a mechanic's lien may be asserted in the jurisdiction where the labor, materials, or equipment were furnished.

15.2. Contract: The agreement between Owner and Contractor identified on the signature page, including all Contract Documents and changes thereto.

15.3. Owner Default: Failure of Owner, which has neither been remedied nor waived, to pay Contractor as required by the Contract or to perform and complete or comply with the other terms thereof.

**FOR INFORMATION ONLY – Name, Address and Telephone**

**Surety Agency or Broker:**

**Owner's Representative (engineer or other party):**

# TAB D

General Conditions





This document has important legal consequences; consultation with an attorney is encouraged with respect to its use or modification. This document should be adapted to the particular circumstances of the contemplated Project and the Controlling Law.

# STANDARD GENERAL CONDITIONS OF THE CONSTRUCTION CONTRACT

Prepared by

**ENGINEERS JOINT CONTRACT DOCUMENTS COMMITTEE**

and

Issued and Published Jointly By



PROFESSIONAL ENGINEERS IN PRIVATE PRACTICE  
*a practice division of the*  
NATIONAL SOCIETY OF PROFESSIONAL ENGINEERS

AMERICAN COUNCIL OF ENGINEERING COMPANIES

AMERICAN SOCIETY OF CIVIL ENGINEERS

This document has been approved and endorsed by



The Associated General Contractors of America

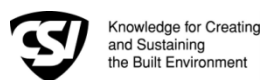

Construction Specifications Institute

Copyright ©2002

National Society of Professional Engineers  
1420 King Street, Alexandria, VA 22314

American Council of Engineering Companies  
1015 15th Street, N.W., Washington, DC 20005

American Society of Civil Engineers  
1801 Alexander Bell Drive, Reston, VA 20191-4400

These General Conditions have been prepared for use with the Suggested Forms of Agreement Between Owner and Contractor Nos. C-520 or C-525 (2002 Editions). Their provisions are interrelated and a change in one may necessitate a change in the other. Comments concerning their usage are contained in the EJCDC Construction Documents, General and Instructions (No. C-001) (2002 Edition). For guidance in the preparation of Supplementary Conditions, see Guide to the Preparation of Supplementary Conditions (No. C-800) (2002 Edition).

## TABLE OF CONTENTS

	<u>Page</u>
ARTICLE 1 - DEFINITIONS AND TERMINOLOGY .....	6
1.01 <i>Defined Terms</i> .....	6
1.02 <i>Terminology</i> .....	8
ARTICLE 2 - PRELIMINARY MATTERS .....	9
2.01 <i>Delivery of Bonds and Evidence of Insurance</i> .....	9
2.02 <i>Copies of Documents</i> .....	9
2.03 <i>Commencement of Contract Times; Notice to Proceed</i> .....	9
2.04 <i>Starting the Work</i> .....	9
2.05 <i>Before Starting Construction</i> .....	9
2.06 <i>Preconstruction Conference</i> .....	9
2.07 <i>Initial Acceptance of Schedules</i> .....	9
ARTICLE 3 - CONTRACT DOCUMENTS: INTENT, AMENDING, REUSE .....	10
3.01 <i>Intent</i> .....	10
3.02 <i>Reference Standards</i> .....	10
3.03 <i>Reporting and Resolving Discrepancies</i> .....	10
3.04 <i>Amending and Supplementing Contract Documents</i> .....	11
3.05 <i>Reuse of Documents</i> .....	11
3.06 <i>Electronic Data</i> .....	11
ARTICLE 4 - AVAILABILITY OF LANDS; SUBSURFACE AND PHYSICAL CONDITIONS; HAZARDOUS ENVIRONMENTAL CONDITIONS; REFERENCE POINTS .....	11
4.01 <i>Availability of Lands</i> .....	11
4.02 <i>Subsurface and Physical Conditions</i> .....	12
4.03 <i>Differing Subsurface or Physical Conditions</i> .....	12
4.04 <i>Underground Facilities</i> .....	13
4.05 <i>Reference Points</i> .....	13
4.06 <i>Hazardous Environmental Condition at Site</i> .....	13
ARTICLE 5 - BONDS AND INSURANCE .....	14
5.01 <i>Performance, Payment, and Other Bonds</i> .....	14
5.02 <i>Licensed Sureties and Insurers</i> .....	15
5.03 <i>Certificates of Insurance</i> .....	15
5.04 <i>Contractor's Liability Insurance</i> .....	15
5.05 <i>Owner's Liability Insurance</i> .....	16
5.06 <i>Property Insurance</i> .....	16
5.07 <i>Waiver of Rights</i> .....	17
5.08 <i>Receipt and Application of Insurance Proceeds</i> .....	17
5.09 <i>Acceptance of Bonds and Insurance; Option to Replace</i> .....	17
5.10 <i>Partial Utilization, Acknowledgment of Property Insurer</i> .....	18
ARTICLE 6 - CONTRACTOR'S RESPONSIBILITIES .....	18
6.01 <i>Supervision and Superintendence</i> .....	18
6.02 <i>Labor; Working Hours</i> .....	18
6.03 <i>Services, Materials, and Equipment</i> .....	18
6.04 <i>Progress Schedule</i> .....	18
6.05 <i>Substitutes and "Or-Equals"</i> .....	19
6.06 <i>Concerning Subcontractors, Suppliers, and Others</i> .....	20
6.07 <i>Patent Fees and Royalties</i> .....	21
6.08 <i>Permits</i> .....	21
6.09 <i>Laws and Regulations</i> .....	21
6.10 <i>Taxes</i> .....	22
6.11 <i>Use of Site and Other Areas</i> .....	22
6.12 <i>Record Documents</i> .....	22
6.13 <i>Safety and Protection</i> .....	22
6.14 <i>Safety Representative</i> .....	23
6.15 <i>Hazard Communication Programs</i> .....	23

6.16	<i>Emergencies</i> .....	23
6.17	<i>Shop Drawings and Samples</i> .....	23
6.18	<i>Continuing the Work</i> .....	24
6.19	<i>Contractor's General Warranty and Guarantee</i> .....	24
6.20	<i>Indemnification</i> .....	24
6.21	<i>Delegation of Professional Design Services</i> .....	25
ARTICLE 7 - OTHER WORK AT THE SITE .....		25
7.01	<i>Related Work at Site</i> .....	25
7.02	<i>Coordination</i> .....	26
7.03	<i>Legal Relationships</i> .....	26
ARTICLE 8 - OWNER'S RESPONSIBILITIES .....		26
8.01	<i>Communications to Contractor</i> .....	26
8.02	<i>Replacement of Engineer</i> .....	26
8.03	<i>Furnish Data</i> .....	26
8.04	<i>Pay When Due</i> .....	26
8.05	<i>Lands and Easements; Reports and Tests</i> .....	26
8.06	<i>Insurance</i> .....	26
8.07	<i>Change Orders</i> .....	26
8.08	<i>Inspections, Tests, and Approvals</i> .....	26
8.09	<i>Limitations on Owner's Responsibilities</i> .....	27
8.10	<i>Undisclosed Hazardous Environmental Condition</i> .....	27
8.11	<i>Evidence of Financial Arrangements</i> .....	27
ARTICLE 9 - ENGINEER'S STATUS DURING CONSTRUCTION.....		27
9.01	<i>Owner's Representative</i> .....	27
9.02	<i>Visits to Site</i> .....	27
9.03	<i>Project Representative</i> .....	27
9.04	<i>Authorized Variations in Work</i> .....	27
9.05	<i>Rejecting Defective Work</i> .....	27
9.06	<i>Shop Drawings, Change Orders and Payments</i> .....	28
9.07	<i>Determinations for Unit Price Work</i> .....	28
9.08	<i>Decisions on Requirements of Contract Documents and Acceptability of Work</i> .....	28
9.09	<i>Limitations on Engineer's Authority and Responsibilities</i> .....	28
ARTICLE 10 - CHANGES IN THE WORK; CLAIMS .....		28
10.01	<i>Authorized Changes in the Work</i> .....	28
10.02	<i>Unauthorized Changes in the Work</i> .....	29
10.03	<i>Execution of Change Orders</i> .....	29
10.04	<i>Notification to Surety</i> .....	29
10.05	<i>Claims</i> .....	29
ARTICLE 11 - COST OF THE WORK; ALLOWANCES; UNIT PRICE WORK.....		30
11.01	<i>Cost of the Work</i> .....	30
11.02	<i>Allowances</i> .....	31
11.03	<i>Unit Price Work</i> .....	31
ARTICLE 12 - CHANGE OF CONTRACT PRICE; CHANGE OF CONTRACT TIMES .....		32
12.01	<i>Change of Contract Price</i> .....	32
12.02	<i>Change of Contract Times</i> .....	33
12.03	<i>Delays</i> .....	33
ARTICLE 13 - TESTS AND INSPECTIONS; CORRECTION, REMOVAL OR ACCEPTANCE OF DEFECTIVE WORK.....		33
13.01	<i>Notice of Defects</i> .....	33
13.02	<i>Access to Work</i> .....	33
13.03	<i>Tests and Inspections</i> .....	33
13.04	<i>Uncovering Work</i> .....	34
13.05	<i>Owner May Stop the Work</i> .....	34
13.06	<i>Correction or Removal of Defective Work</i> .....	34
13.07	<i>Correction Period</i> .....	34
13.08	<i>Acceptance of Defective Work</i> .....	35
13.09	<i>Owner May Correct Defective Work</i> .....	35
ARTICLE 14 - PAYMENTS TO CONTRACTOR AND COMPLETION .....		36
14.01	<i>Schedule of Values</i> .....	36
14.02	<i>Progress Payments</i> .....	36
14.03	<i>Contractor's Warranty of Title</i> .....	37
14.04	<i>Substantial Completion</i> .....	37

14.05	<i>Partial Utilization</i> .....	38
14.06	<i>Final Inspection</i> .....	38
14.07	<i>Final Payment</i> .....	38
14.08	<i>Final Completion Delayed</i> .....	39
14.09	<i>Waiver of Claims</i> .....	39
ARTICLE 15 - SUSPENSION OF WORK AND TERMINATION .....		39
15.01	<i>Owner May Suspend Work</i> .....	39
15.02	<i>Owner May Terminate for Cause</i> .....	39
15.03	<i>Owner May Terminate For Convenience</i> .....	40
15.04	<i>Contractor May Stop Work or Terminate</i> .....	40
ARTICLE 16 - DISPUTE RESOLUTION .....		41
16.01	<i>Methods and Procedures</i> .....	41
ARTICLE 17 - MISCELLANEOUS .....		41
17.01	<i>Giving Notice</i> .....	41
17.02	<i>Computation of Times</i> .....	41
17.03	<i>Cumulative Remedies</i> .....	41
17.04	<i>Survival of Obligations</i> .....	41
17.05	<i>Controlling Law</i> .....	41
17.06	<i>Headings</i> .....	41

## GENERAL CONDITIONS

### ARTICLE 1 - DEFINITIONS AND TERMINOLOGY

---

#### 1.01 *Defined Terms*

A. Wherever used in the Bidding Requirements or Contract Documents and printed with initial capital letters, the terms listed below will have the meanings indicated which are applicable to both the singular and plural thereof. In addition to terms specifically defined, terms with initial capital letters in the Contract Documents include references to identified articles and paragraphs, and the titles of other documents or forms.

1. *Addenda*--Written or graphic instruments issued prior to the opening of Bids which clarify, correct, or change the Bidding Requirements or the proposed Contract Documents.

2. *Agreement*--The written instrument which is evidence of the agreement between Owner and Contractor covering the Work.

3. *Application for Payment*--The form acceptable to Engineer which is to be used by Contractor during the course of the Work in requesting progress or final payments and which is to be accompanied by such supporting documentation as is required by the Contract Documents.

4. *Asbestos*--Any material that contains more than one percent asbestos and is friable or is releasing asbestos fibers into the air above current action levels established by the United States Occupational Safety and Health Administration.

5. *Bid*--The offer or proposal of a Bidder submitted on the prescribed form setting forth the prices for the Work to be performed.

6. *Bidder*--The individual or entity who submits a Bid directly to Owner.

7. *Bidding Documents*--The Bidding Requirements and the proposed Contract Documents (including all Addenda).

8. *Bidding Requirements*--The Advertisement or Invitation to Bid, Instructions to Bidders, bid security of acceptable form, if any, and the Bid Form with any supplements.

9. *Change Order*--A document recommended by Engineer which is signed by Contractor and Owner and authorizes an addition, deletion, or revision in the Work or an adjustment in the Contract Price or the Contract

Times, issued on or after the Effective Date of the Agreement.

10. *Claim*--A demand or assertion by Owner or Contractor seeking an adjustment of Contract Price or Contract Times, or both, or other relief with respect to the terms of the Contract. A demand for money or services by a third party is not a Claim.

11. *Contract*--The entire and integrated written agreement between the Owner and Contractor concerning the Work. The Contract supersedes prior negotiations, representations, or agreements, whether written or oral.

12. *Contract Documents*-- Those items so designated in the Agreement. Only printed or hard copies of the items listed in the Agreement are Contract Documents. Approved Shop Drawings, other Contractor's submittals, and the reports and drawings of subsurface and physical conditions are not Contract Documents.

13. *Contract Price*--The moneys payable by Owner to Contractor for completion of the Work in accordance with the Contract Documents as stated in the Agreement (subject to the provisions of Paragraph 11.03 in the case of Unit Price Work).

14. *Contract Times*--The number of days or the dates stated in the Agreement to: (i) achieve Milestones, if any, (ii) achieve Substantial Completion; and (iii) complete the Work so that it is ready for final payment as evidenced by Engineer's written recommendation of final payment.

15. *Contractor*--The individual or entity with whom Owner has entered into the Agreement.

16. *Cost of the Work*--See Paragraph 11.01.A for definition.

17. *Drawings*--That part of the Contract Documents prepared or approved by Engineer which graphically shows the scope, extent, and character of the Work to be performed by Contractor. Shop Drawings and other Contractor submittals are not Drawings as so defined.

18. *Effective Date of the Agreement*--The date indicated in the Agreement on which it becomes effective, but if no such date is indicated, it means the date on which the Agreement is signed and delivered by the last of the two parties to sign and deliver.

19. *Engineer*--The individual or entity named as such in the Agreement.

20. *Field Order*--A written order issued by Engineer which requires minor changes in the Work but which does not involve a change in the Contract Price or the Contract Times.

21. *General Requirements*--Sections of Division 1 of the Specifications. The General Requirements pertain to all sections of the Specifications.

22. *Hazardous Environmental Condition*--The presence at the Site of Asbestos, PCBs, Petroleum, Hazardous Waste, or Radioactive Material in such quantities or circumstances that may present a substantial danger to persons or property exposed thereto in connection with the Work.

23. *Hazardous Waste*--The term Hazardous Waste shall have the meaning provided in Section 1004 of the Solid Waste Disposal Act (42 USC Section 6903) as amended from time to time.

24. *Laws and Regulations; Laws or Regulations*--Any and all applicable laws, rules, regulations, ordinances, codes, and orders of any and all governmental bodies, agencies, authorities, and courts having jurisdiction.

25. *Liens*--Charges, security interests, or encumbrances upon Project funds, real property, or personal property.

26. *Milestone*--A principal event specified in the Contract Documents relating to an intermediate completion date or time prior to Substantial Completion of all the Work.

27. *Notice of Award*--The written notice by Owner to the Successful Bidder stating that upon timely compliance by the Successful Bidder with the conditions precedent listed therein, Owner will sign and deliver the Agreement.

28. *Notice to Proceed*--A written notice given by Owner to Contractor fixing the date on which the Contract Times will commence to run and on which Contractor shall start to perform the Work under the Contract Documents.

29. *Owner*--The individual or entity with whom Contractor has entered into the Agreement and for whom the Work is to be performed.

30. *PCBs*--Polychlorinated biphenyls.

31. *Petroleum*--Petroleum, including crude oil or any fraction thereof which is liquid at standard conditions of temperature and pressure (60 degrees Fahrenheit and 14.7 pounds per square inch absolute), such as oil, petroleum, fuel oil, oil sludge, oil refuse, gasoline,

kerosene, and oil mixed with other non-Hazardous Waste and crude oils.

32. *Progress Schedule*--A schedule, prepared and maintained by Contractor, describing the sequence and duration of the activities comprising the Contractor's plan to accomplish the Work within the Contract Times.

33. *Project*--The total construction of which the Work to be performed under the Contract Documents may be the whole, or a part.

34. *Project Manual*--The bound documentary information prepared for bidding and constructing the Work. A listing of the contents of the Project Manual, which may be bound in one or more volumes, is contained in the table(s) of contents.

35. *Radioactive Material*--Source, special nuclear, or byproduct material as defined by the Atomic Energy Act of 1954 (42 USC Section 2011 et seq.) as amended from time to time.

36. *Related Entity* -- An officer, director, partner, employee, agent, consultant, or subcontractor.

37. *Resident Project Representative*--The authorized representative of Engineer who may be assigned to the Site or any part thereof.

38. *Samples*--Physical examples of materials, equipment, or workmanship that are representative of some portion of the Work and which establish the standards by which such portion of the Work will be judged.

39. *Schedule of Submittals*--A schedule, prepared and maintained by Contractor, of required submittals and the time requirements to support scheduled performance of related construction activities.

40. *Schedule of Values*--A schedule, prepared and maintained by Contractor, allocating portions of the Contract Price to various portions of the Work and used as the basis for reviewing Contractor's Applications for Payment.

41. *Shop Drawings*--All drawings, diagrams, illustrations, schedules, and other data or information which are specifically prepared or assembled by or for Contractor and submitted by Contractor to illustrate some portion of the Work.

42. *Site*--Lands or areas indicated in the Contract Documents as being furnished by Owner upon which the Work is to be performed, including rights-of-way and easements for access thereto, and such other lands

furnished by Owner which are designated for the use of Contractor.

43. *Specifications*--That part of the Contract Documents consisting of written requirements for materials, equipment, systems, standards and workmanship as applied to the Work, and certain administrative requirements and procedural matters applicable thereto.

44. *Subcontractor*--An individual or entity having a direct contract with Contractor or with any other Subcontractor for the performance of a part of the Work at the Site.

45. *Substantial Completion*--The time at which the Work (or a specified part thereof) has progressed to the point where, in the opinion of Engineer, the Work (or a specified part thereof) is sufficiently complete, in accordance with the Contract Documents, so that the Work (or a specified part thereof) can be utilized for the purposes for which it is intended. The terms "substantially complete" and "substantially completed" as applied to all or part of the Work refer to Substantial Completion thereof.

46. *Successful Bidder*--The Bidder submitting a responsive Bid to whom Owner makes an award.

47. *Supplementary Conditions*--That part of the Contract Documents which amends or supplements these General Conditions.

48. *Supplier*--A manufacturer, fabricator, supplier, distributor, materialman, or vendor having a direct contract with Contractor or with any Subcontractor to furnish materials or equipment to be incorporated in the Work by Contractor or any Subcontractor.

49. *Underground Facilities*--All underground pipelines, conduits, ducts, cables, wires, manholes, vaults, tanks, tunnels, or other such facilities or attachments, and any encasements containing such facilities, including those that convey electricity, gases, steam, liquid petroleum products, telephone or other communications, cable television, water, wastewater, storm water, other liquids or chemicals, or traffic or other control systems.

50. *Unit Price Work*--Work to be paid for on the basis of unit prices.

51. *Work*--The entire construction or the various separately identifiable parts thereof required to be provided under the Contract Documents. Work includes and is the result of performing or providing all labor, services, and documentation necessary to produce such construction, and furnishing, installing, and incorporating

all materials and equipment into such construction, all as required by the Contract Documents.

52. *Work Change Directive*--A written statement to Contractor issued on or after the Effective Date of the Agreement and signed by Owner and recommended by Engineer ordering an addition, deletion, or revision in the Work, or responding to differing or unforeseen subsurface or physical conditions under which the Work is to be performed or to emergencies. A Work Change Directive will not change the Contract Price or the Contract Times but is evidence that the parties expect that the change ordered or documented by a Work Change Directive will be incorporated in a subsequently issued Change Order following negotiations by the parties as to its effect, if any, on the Contract Price or Contract Times.

## 1.02 Terminology

A. The following words or terms are not defined but, when used in the Bidding Requirements or Contract Documents, have the following meaning.

### B. Intent of Certain Terms or Adjectives

1. The Contract Documents include the terms "as allowed," "as approved," "as ordered," "as directed" or terms of like effect or import to authorize an exercise of professional judgment by Engineer. In addition, the adjectives "reasonable," "suitable," "acceptable," "proper," "satisfactory," or adjectives of like effect or import are used to describe an action or determination of Engineer as to the Work. It is intended that such exercise of professional judgment, action or determination will be solely to evaluate, in general, the Work for compliance with the requirements of and information in the Contract Documents and conformance with the design concept of the completed Project as a functioning whole as shown or indicated in the Contract Documents (unless there is a specific statement indicating otherwise). The use of any such term or adjective is not intended to and shall not be effective to assign to Engineer any duty or authority to supervise or direct the performance of the Work or any duty or authority to undertake responsibility contrary to the provisions of Paragraph 9.09 or any other provision of the Contract Documents.

### C. Day

1. The word "day" means a calendar day of 24 hours measured from midnight to the next midnight.

### D. Defective

1. The word "defective," when modifying the word "Work," refers to Work that is unsatisfactory, faulty, or deficient in that it:



a. does not conform to the Contract Documents, or

b. does not meet the requirements of any applicable inspection, reference standard, test, or approval referred to in the Contract Documents, or

c. has been damaged prior to Engineer's - recommendation of final payment (unless responsibility for the protection thereof has been assumed by Owner at Substantial Completion in accordance with Paragraph 14.04 or 14.05).

#### E. *Furnish, Install, Perform, Provide*

1. The word "furnish," when used in connection with services, materials, or equipment, shall mean to supply and deliver said services, materials, or equipment to the Site (or some other specified location) ready for use or installation and in usable or operable condition.

2. The word "install," when used in connection with services, materials, or equipment, shall mean to put into use or place in final position said services, materials, or equipment complete and ready for intended use.

3. The words "perform" or "provide," when used in connection with services, materials, or equipment, shall mean to furnish and install said services, materials, or equipment complete and ready for intended use.

4. When "furnish," "install," "perform," or "provide" is not used in connection with services, materials, or equipment in a context clearly requiring an obligation of Contractor, "provide" is implied.

F. Unless stated otherwise in the Contract Documents, words or phrases which have a well-known technical or construction industry or trade meaning are used in the Contract Documents in accordance with such recognized meaning.

## ARTICLE 2 - PRELIMINARY MATTERS

---

### 2.01 *Delivery of Bonds and Evidence of Insurance*

A. When Contractor delivers the executed counterparts of the Agreement to Owner, Contractor shall also deliver to Owner such bonds as Contractor may be required to furnish.

B. *Evidence of Insurance:* Before any Work at the Site is started, Contractor and Owner shall each deliver to the other, with copies to each additional insured identified in the Supplementary Conditions, certificates of insurance (and other evidence of insurance which either of them or

any additional insured may reasonably request) which Contractor and Owner respectively are required to purchase and maintain in accordance with Article 5.

### 2.02 *Copies of Documents*

A. Owner shall furnish to Contractor up to ten printed or hard copies of the Drawings and Project Manual. Additional copies will be furnished upon request at the cost of reproduction.

### 2.03 *Commencement of Contract Times; Notice to Proceed*

A. The Contract Times will commence to run on the thirtieth day after the Effective Date of the Agreement or, if a Notice to Proceed is given, on the day indicated in the Notice to Proceed. A Notice to Proceed may be given at any time within 30 days after the Effective Date of the Agreement. In no event will the Contract Times commence to run later than the sixtieth day after the day of Bid opening or the thirtieth day after the Effective Date of the Agreement, whichever date is earlier.

### 2.04 *Starting the Work*

A. Contractor shall start to perform the Work on the date when the Contract Times commence to run. No Work shall be done at the Site prior to the date on which the Contract Times commence to run.

### 2.05 *Before Starting Construction*

A. *Preliminary Schedules:* Within 10 days after the Effective Date of the Agreement (unless otherwise specified in the General Requirements), Contractor shall submit to Engineer for timely review:

1. a preliminary Progress Schedule; indicating the times (numbers of days or dates) for starting and completing the various stages of the Work, including any Milestones specified in the Contract Documents;

2. a preliminary Schedule of Submittals; and

3. a preliminary Schedule of Values for all of the Work which includes quantities and prices of items which when added together equal the Contract Price and subdivides the Work into component parts in sufficient detail to serve as the basis for progress payments during performance of the Work. Such prices will include an appropriate amount of overhead and profit applicable to each item of Work.

### 2.06 *Preconstruction Conference*

A. Before any Work at the Site is started, a conference attended by Owner, Contractor, Engineer, and others as appropriate will be held to establish a working understanding among the parties as to the Work and to

discuss the schedules referred to in Paragraph 2.05.A, procedures for handling Shop Drawings and other submittals, processing Applications for Payment, and maintaining required records.

### 2.07 *Initial Acceptance of Schedules*

A. At least 10 days before submission of the first Application for Payment a conference attended by Contractor, Engineer, and others as appropriate will be held to review for acceptability to Engineer as provided below the schedules submitted in accordance with Paragraph 2.05.A. Contractor shall have an additional 10 days to make corrections and adjustments and to complete and resubmit the schedules. No progress payment shall be made to Contractor until acceptable schedules are submitted to Engineer.

1. The Progress Schedule will be acceptable to Engineer if it provides an orderly progression of the Work to completion within the Contract Times. Such acceptance will not impose on Engineer responsibility for the Progress Schedule, for sequencing, scheduling, or progress of the Work nor interfere with or relieve Contractor from Contractor's full responsibility therefor.

2. Contractor's Schedule of Submittals will be acceptable to Engineer if it provides a workable arrangement for reviewing and processing the required submittals.

3. Contractor's Schedule of Values will be acceptable to Engineer as to form and substance if it provides a reasonable allocation of the Contract Price to component parts of the Work.

## ARTICLE 3 - CONTRACT DOCUMENTS: INTENT, AMENDING, REUSE

---

### 3.01 *Intent*

A. The Contract Documents are complementary; what is required by one is as binding as if required by all.

B. It is the intent of the Contract Documents to describe a functionally complete Project (or part thereof) to be constructed in accordance with the Contract Documents. Any labor, documentation, services, materials, or equipment that may reasonably be inferred from the Contract Documents or from prevailing custom or trade usage as being required to produce the intended result will be provided whether or not specifically called for at no additional cost to Owner.

C. Clarifications and interpretations of the Contract Documents shall be issued by Engineer as provided in Article 9.

### 3.02 *Reference Standards*

#### A. Standards, Specifications, Codes, Laws, and Regulations

1. Reference to standards, specifications, manuals, or codes of any technical society, organization, or association, or to Laws or Regulations, whether such reference be specific or by implication, shall mean the standard, specification, manual, code, or Laws or Regulations in effect at the time of opening of Bids (or on the Effective Date of the Agreement if there were no Bids), except as may be otherwise specifically stated in the Contract Documents.

2. No provision of any such standard, specification, manual or code, or any instruction of a Supplier shall be effective to change the duties or responsibilities of Owner, Contractor, or Engineer, or any of their subcontractors, consultants, agents, or employees from those set forth in the Contract Documents. No such provision or instruction shall be effective to assign to Owner, or Engineer, or any of, their Related Entities, any duty or authority to supervise or direct the performance of the Work or any duty or authority to undertake responsibility inconsistent with the provisions of the Contract Documents.

### 3.03 *Reporting and Resolving Discrepancies*

#### A. Reporting Discrepancies

1. *Contractor's Review of Contract Documents Before Starting Work:* Before undertaking each part of the Work, Contractor shall carefully study and compare the Contract Documents and check and verify pertinent figures therein and all applicable field measurements. Contractor shall promptly report in writing to Engineer any conflict, error, ambiguity, or discrepancy which Contractor may discover and shall obtain a written interpretation or clarification from Engineer before proceeding with any Work affected thereby.

2. *Contractor's Review of Contract Documents During Performance of Work:* If, during the performance of the Work, Contractor discovers any conflict, error, ambiguity, or discrepancy within the Contract Documents or between the Contract Documents and any provision of any Law or Regulation applicable to the performance of the Work or of any standard, specification, manual or code, or of any instruction of any Supplier, Contractor shall promptly report it to Engineer in writing. Contractor shall not proceed with the Work affected thereby (except in an emergency as required by Paragraph 6.16.A) until an amendment or supplement to the Contract Documents

has been issued by one of the methods indicated in Paragraph 3.04.

3. Contractor shall not be liable to Owner or Engineer for failure to report any conflict, error, ambiguity, or discrepancy in the Contract Documents unless Contractor knew or reasonably should have known thereof.

#### B. Resolving Discrepancies

1. Except as may be otherwise specifically stated in the Contract Documents, the provisions of the Contract Documents shall take precedence in resolving any conflict, error, ambiguity, or discrepancy between the provisions of the Contract Documents and:

- a. the provisions of any standard, specification, manual, code, or instruction (whether or not specifically incorporated by reference in the Contract Documents); or
- b. the provisions of any Laws or Regulations applicable to the performance of the Work (unless such an interpretation of the provisions of the Contract Documents would result in violation of such Law or Regulation).

#### 3.04 *Amending and Supplementing Contract Documents*

A. The Contract Documents may be amended to provide for additions, deletions, and revisions in the Work or to modify the terms and conditions thereof by either a Change Order or a Work Change Directive.

B. The requirements of the Contract Documents may be supplemented, and minor variations and deviations in the Work may be authorized, by one or more of the following ways:

1. A Field Order;
2. Engineer's approval of a Shop Drawing or Sample; (Subject to the provisions of Paragraph 6.17.D.3); or
3. Engineer's written interpretation or clarification.

#### 3.05 *Reuse of Documents*

A. Contractor and any Subcontractor or Supplier or other individual or entity performing or furnishing all of the Work under a direct or indirect contract with Contractor, shall not:

1. have or acquire any title to or ownership rights in any of the Drawings, Specifications, or

other documents (or copies of any thereof) prepared by or bearing the seal of Engineer or Engineer's consultants, including electronic media editions; or

2. reuse any of such Drawings, Specifications, other documents, or copies thereof on extensions of the Project or any other project without written consent of Owner and Engineer and specific written verification or adaption by Engineer.

B. The prohibition of this Paragraph 3.05 will survive final payment, or termination of the Contract. Nothing herein shall preclude Contractor from retaining copies of the Contract Documents for record purposes.

#### 3.06 *Electronic Data*

A. Copies of data furnished by Owner or Engineer to Contractor or Contractor to Owner or Engineer that may be relied upon are limited to the printed copies (also known as hard copies). Files in electronic media format of text, data, graphics, or other types are furnished only for the convenience of the receiving party. Any conclusion or information obtained or derived from such electronic files will be at the user's sole risk. If there is a discrepancy between the electronic files and the hard copies, the hard copies govern.

B. Because data stored in electronic media format can deteriorate or be modified inadvertently or otherwise without authorization of the data's creator, the party receiving electronic files agrees that it will perform acceptance tests or procedures within 60 days, after which the receiving party shall be deemed to have accepted the data thus transferred. Any errors detected within the 60-day acceptance period will be corrected by the transferring party..

C. When transferring documents in electronic media format, the transferring party makes no representations as to long term compatibility, usability, or readability of documents resulting from the use of software application packages, operating systems, or computer hardware differing from those used by the data's creator.

### ARTICLE 4 - AVAILABILITY OF LANDS; SUBSURFACE AND PHYSICAL CONDITIONS; HAZARDOUS ENVIRONMENTAL CONDITIONS; REFERENCE POINTS

#### 4.01 *Availability of Lands*

A. Owner shall furnish the Site. Owner shall notify Contractor of any encumbrances or restrictions not of general application but specifically related to use of the Site with which Contractor must comply in performing the Work. Owner will obtain in a timely manner and pay for easements for permanent structures or permanent changes in existing facilities. If Contractor and Owner are unable to agree on entitlement to or on the amount or extent, if any, of any adjustment in the Contract Price or Contract Times, or both, as a result of any delay in Owner's furnishing the Site or a part thereof, Contractor may make a Claim therefor as provided in Paragraph 10.05.

B. Upon reasonable written request, Owner shall furnish Contractor with a current statement of record legal title and legal description of the lands upon which the Work is to be performed and Owner's interest therein as necessary for giving notice of or filing a mechanic's or construction lien against such lands in accordance with applicable Laws and Regulations.

C. Contractor shall provide for all additional lands and access thereto that may be required for temporary construction facilities or storage of materials and equipment.

#### 4.02 *Subsurface and Physical Conditions*

A. *Reports and Drawings:* The Supplementary Conditions identify:

1. those reports of explorations and tests of subsurface conditions at or contiguous to the Site that Engineer has used in preparing the Contract Documents; and

2. those drawings of physical conditions in or relating to existing surface or subsurface structures at or contiguous to the Site (except Underground Facilities) that Engineer has used in preparing the Contract Documents.

B. *Limited Reliance by Contractor on Technical Data Authorized:* Contractor may rely upon the general accuracy of the "technical data" contained in such reports and drawings, but such reports and drawings are not Contract Documents. Such "technical data" is identified in the Supplementary Conditions. Except for such reliance on such "technical data," Contractor may not rely upon or make any claim against Owner or Engineer, or any of their Related Entities with respect to:

1. the completeness of such reports and drawings for Contractor's purposes, including, but not limited to, any aspects of the means, methods, techniques, sequences, and procedures of construction to be employed by Contractor, and safety precautions and programs incident thereto; or

2. other data, interpretations, opinions, and information contained in such reports or shown or indicated in such drawings; or

3. any Contractor interpretation of or conclusion drawn from any "technical data" or any such other data, interpretations, opinions, or information.

#### 4.03 *Differing Subsurface or Physical Conditions*

A. *Notice:* If Contractor believes that any subsurface or physical condition at or contiguous to the Site that is uncovered or revealed either:

1. is of such a nature as to establish that any "technical data" on which Contractor is entitled to rely as provided in Paragraph 4.02 is materially inaccurate; or

2. is of such a nature as to require a change in the Contract Documents; or

3. differs materially from that shown or indicated in the Contract Documents; or

4. is of an unusual nature, and differs materially from conditions ordinarily encountered and generally recognized as inherent in work of the character provided for in the Contract Documents;

then Contractor shall, promptly after becoming aware thereof and before further disturbing the subsurface or physical conditions or performing any Work in connection therewith (except in an emergency as required by Paragraph 6.16.A), notify Owner and Engineer in writing about such condition. Contractor shall not further disturb such condition or perform any Work in connection therewith (except as aforesaid) until receipt of written order to do so.

B. *Engineer's Review:* After receipt of written notice as required by Paragraph 4.03.A, Engineer will promptly review the pertinent condition, determine the necessity of Owner's obtaining additional exploration or tests with respect thereto, and advise Owner in writing (with a copy to Contractor) of Engineer's findings and conclusions.

#### C. Possible Price and Times Adjustments

1. The Contract Price or the Contract Times, or both, will be equitably adjusted to the extent that the existence of such differing subsurface or physical condition causes an increase or decrease in Contractor's cost of, or time required for, performance of the Work; subject, however, to the following:

a. such condition must meet any one or more of the categories described in Paragraph 4.03.A; and

b. with respect to Work that is paid for on a Unit Price Basis, any adjustment in Contract Price will be subject to the provisions of Paragraphs 9.07 and 11.03.

2. Contractor shall not be entitled to any adjustment in the Contract Price or Contract Times if:

a. Contractor knew of the existence of such conditions at the time Contractor made a final commitment to Owner with respect to Contract Price and Contract Times by the submission of a Bid or becoming bound under a negotiated contract; or

b. the existence of such condition could reasonably have been discovered or revealed as a result of any examination, investigation, exploration, test, or study of the Site and contiguous areas required by the Bidding Requirements or Contract Documents to be conducted by or for Contractor prior to Contractor's making such final commitment; or

c. Contractor failed to give the written notice as required by Paragraph 4.03.A.

3. If Owner and Contractor are unable to agree on entitlement to or on the amount or extent, if any, of any adjustment in the Contract Price or Contract Times, or both, a Claim may be made therefor as provided in Paragraph 10.05. However, Owner and Engineer, and any of their Related Entities shall not be liable to Contractor for any claims, costs, losses, or damages (including but not limited to all fees and charges of engineers, architects, attorneys, and other professionals and all court or arbitration or other dispute resolution costs) sustained by Contractor on or in connection with any other project or anticipated project.

#### 4.04 *Underground Facilities*

*A. Shown or Indicated:* The information and data shown or indicated in the Contract Documents with respect to existing Underground Facilities at or contiguous to the Site is based on information and data furnished to Owner or Engineer by the owners of such Underground Facilities, including Owner, or by others. Unless it is otherwise expressly provided in the Supplementary Conditions:

1. Owner and Engineer shall not be responsible for the accuracy or completeness of any such information or data; and

2. the cost of all of the following will be included in the Contract Price, and Contractor shall have full responsibility for:

a. reviewing and checking all such information and data,

b. locating all Underground Facilities shown or indicated in the Contract Documents,

c. coordination of the Work with the owners of such Underground Facilities, including Owner, during construction, and

d. the safety and protection of all such Underground Facilities and repairing any damage thereto resulting from the Work.

#### *B. Not Shown or Indicated*

1. If an Underground Facility is uncovered or revealed at or contiguous to the Site which was not shown or indicated, or not shown or indicated with reasonable accuracy in the Contract Documents, Contractor shall, promptly after becoming aware thereof and before further disturbing conditions affected thereby or performing any Work in connection therewith (except in an emergency as required by Paragraph 6.16.A), identify the owner of such Underground Facility and give written notice to that owner and to Owner and Engineer. Engineer will promptly review the Underground Facility and determine the extent, if any, to which a change is required in the Contract Documents to reflect and document the consequences of the existence or location of the Underground Facility. During such time, Contractor shall be responsible for the safety and protection of such Underground Facility.

2. If Engineer concludes that a change in the Contract Documents is required, a Work Change Directive or a Change Order will be issued to reflect and document such consequences. An equitable adjustment shall be made in the Contract Price or Contract Times, or both, to the extent that they are attributable to the existence or location of any Underground Facility that was not shown or indicated or not shown or indicated with reasonable accuracy in the Contract Documents and that Contractor did not know of and could not reasonably have been expected to be aware of or to have anticipated. If Owner and Contractor are unable to agree on entitlement to or on the amount or extent, if any, of any such adjustment in Contract Price or Contract Times, Owner or Contractor may make a Claim therefor as provided in Paragraph 10.05.

#### 4.05 *Reference Points*

A. Owner shall provide engineering surveys to establish reference points for construction which in Engineer's judgment are necessary to enable Contractor to proceed with the Work. Contractor shall be responsible for laying out the Work, shall protect and preserve the established reference points and property monuments, and shall make no changes or relocations without the prior written approval of Owner. Contractor shall report to Engineer whenever any reference point or property monument is lost or destroyed or requires relocation because of necessary changes in grades or locations, and shall be responsible for the accurate replacement or relocation of such reference points or property monuments by professionally qualified personnel.

#### 4.06 *Hazardous Environmental Condition at Site*

A. *Reports and Drawings:* Reference is made to the Supplementary Conditions for the identification of those reports and drawings relating to a Hazardous Environmental Condition identified at the Site, if any, that have been utilized by the Engineer in the preparation of the Contract Documents.

B. *Limited Reliance by Contractor on Technical Data Authorized:* Contractor may rely upon the general accuracy of the "technical data" contained in such reports and drawings, but such reports and drawings are not Contract Documents. Such "technical data" is identified in the Supplementary Conditions. Except for such reliance on such "technical data," Contractor may not rely upon or make any claim against Owner or Engineer, or any of their Related Entities with respect to:

1. the completeness of such reports and drawings for Contractor's purposes, including, but not limited to, any aspects of the means, methods, techniques, sequences and procedures of construction to be employed by Contractor and safety precautions and programs incident thereto; or
2. other data, interpretations, opinions and information contained in such reports or shown or indicated in such drawings; or
3. any Contractor interpretation of or conclusion drawn from any "technical data" or any such other data, interpretations, opinions or information.

C. Contractor shall not be responsible for any Hazardous Environmental Condition uncovered or revealed at the Site which was not shown or indicated in Drawings or Specifications or identified in the Contract Documents to be within the scope of the Work. Contractor shall be responsible for a Hazardous Environmental Condition created with any materials brought to the Site by Contractor, Subcontractors, Suppliers, or anyone else for whom Contractor is responsible.

D. If Contractor encounters a Hazardous Environmental Condition or if Contractor or anyone for whom Contractor is responsible creates a Hazardous Environmental Condition, Contractor shall immediately: (i) secure or otherwise isolate such condition; (ii) stop all Work in connection with such condition and in any area affected thereby (except in an emergency as required by Paragraph 6.16.A); and (iii) notify Owner and Engineer (and promptly thereafter confirm such notice in writing). Owner shall promptly consult with Engineer concerning the necessity for Owner to retain a qualified expert to evaluate such condition or take corrective action, if any.

E. Contractor shall not be required to resume Work in connection with such condition or in any affected area until after Owner has obtained any required permits related thereto and delivered to Contractor written notice: (i) specifying that such condition and any affected area is or has been rendered safe for the resumption of Work; or (ii) specifying any special conditions under which such Work may be resumed safely. If Owner and Contractor cannot agree as to entitlement to or on the amount or extent, if any, of any adjustment in Contract Price or Contract Times, or both, as a result of such Work stoppage or such special conditions under which Work is agreed to be resumed by Contractor, either party may make a Claim therefor as provided in Paragraph 10.05.

F. If after receipt of such written notice Contractor does not agree to resume such Work based on a reasonable belief it is unsafe, or does not agree to resume such Work under such special conditions, then Owner may order the portion of the Work that is in the area affected by such condition to be deleted from the Work. If Owner and Contractor cannot agree as to entitlement to or on the amount or extent, if any, of an adjustment in Contract Price or Contract Times as a result of deleting such portion of the Work, then either party may make a Claim therefor as provided in Paragraph 10.05. Owner may have such deleted portion of the Work performed by Owner's own forces or others in accordance with Article 7.

G. To the fullest extent permitted by Laws and Regulations, Owner shall indemnify and hold harmless Contractor, Subcontractors, and Engineer, and the officers, directors, partners, employees, agents, consultants, and subcontractors of each and any of them from and against all claims, costs, losses, and damages (including but not limited to all fees and charges of engineers, architects, attorneys, and other professionals and all court or arbitration or other dispute resolution costs) arising out of or relating to a Hazardous Environmental Condition, provided that such Hazardous Environmental Condition: (i) was not shown or indicated in the Drawings or Specifications or identified in the Contract Documents to be included within the scope of the Work, and (ii) was not created by Contractor or by anyone for whom Contractor is responsible. Nothing in this Paragraph 4.06. G shall obligate Owner to indemnify any individual or entity from and against the consequences of that individual's or entity's own negligence.

H. To the fullest extent permitted by Laws and Regulations, Contractor shall indemnify and hold harmless Owner and Engineer, and the officers, directors, partners, employees, agents, consultants, and subcontractors of each and any of them from and against all claims, costs, losses, and damages (including but not limited to all fees and charges of engineers, architects, attorneys, and other professionals and all court or arbitration or other dispute resolution costs) arising out of or relating to a Hazardous Environmental Condition created by Contractor or by anyone for whom Contractor is responsible. Nothing in this Paragraph 4.06.H shall obligate Contractor to indemnify any individual or entity from and against the consequences of that individual's or entity's own negligence.

I. The provisions of Paragraphs 4.02, 4.03, and 4.04 do not apply to a Hazardous Environmental Condition uncovered or revealed at the Site.

## ARTICLE 5 - BONDS AND INSURANCE

---

### 5.01 *Performance, Payment, and Other Bonds*

A. Contractor shall furnish performance and payment bonds, each in an amount at least equal to the Contract Price as security for the faithful performance and payment of all of Contractor's obligations under the Contract Documents. These bonds shall remain in effect until one year after the date when final payment becomes due or until completion of the correction period specified in Paragraph 13.07, whichever is later, except as provided otherwise by Laws or Regulations or by the Contract Documents. Contractor shall also furnish such other bonds as are required by the Contract Documents.

B. All bonds shall be in the form prescribed by the Contract Documents except as provided otherwise by Laws or Regulations, and shall be executed by such sureties as are named in the current list of "Companies Holding Certificates of Authority as Acceptable Sureties on Federal Bonds and as Acceptable Reinsuring Companies" as published in Circular 570 (amended) by the Financial Management Service, Surety Bond Branch, U.S. Department of the Treasury. All bonds signed by an agent must be accompanied by a certified copy of the agent's authority to act.

C. If the surety on any bond furnished by Contractor is declared bankrupt or becomes insolvent or its right to do business is terminated in any state where any part of the Project is located or it ceases to meet the requirements of Paragraph 5.01.B, Contractor shall promptly notify Owner and Engineer and shall, within 20 days after the event giving rise to such notification, provide another bond and surety, both of which shall comply with the requirements of Paragraphs 5.01.B and 5.02.

### 5.02 *Licensed Sureties and Insurers*

A. All bonds and insurance required by the Contract Documents to be purchased and maintained by Owner or Contractor shall be obtained from surety or insurance companies that are duly licensed or authorized in the jurisdiction in which the Project is located to issue bonds or insurance policies for the limits and coverages so required. Such surety and insurance companies shall also meet such additional requirements and qualifications as may be provided in the Supplementary Conditions.

### 5.03 *Certificates of Insurance*

A. Contractor shall deliver to Owner, with copies to each additional insured identified in the Supplementary Conditions, certificates of insurance (and other evidence of insurance requested by Owner or any other additional insured) which Contractor is required to purchase and maintain.

B. Owner shall deliver to Contractor, with copies to each additional insured identified in the Supplementary Conditions, certificates of insurance (and other evidence of insurance requested by Contractor or any other additional insured) which Owner is required to purchase and maintain.

### 5.04 *Contractor's Liability Insurance*

A. Contractor shall purchase and maintain such liability and other insurance as is appropriate for the Work being performed and as will provide protection from claims set forth below which may arise out of or result from Contractor's performance of the Work and Contractor's other obligations under the Contract Documents, whether it is to be performed by Contractor, any Subcontractor or Supplier, or by anyone directly or indirectly employed by any of them to perform any of the Work, or by anyone for whose acts any of them may be liable:

1. claims under workers' compensation, disability benefits, and other similar employee benefit acts;

2. claims for damages because of bodily injury, occupational sickness or disease, or death of Contractor's employees;

3. claims for damages because of bodily injury, sickness or disease, or death of any person other than Contractor's employees;

4. claims for damages insured by reasonably available personal injury liability coverage which are sustained:

a. by any person as a result of an offense directly or indirectly related to the employment of such person by Contractor, or

b. by any other person for any other reason;

5. claims for damages, other than to the Work itself, because of injury to or destruction of tangible property wherever located, including loss of use resulting therefrom; and

6. claims for damages because of bodily injury or death of any person or property damage arising out of the ownership, maintenance or use of any motor vehicle.

B. The policies of insurance required by this Paragraph 5.04 shall:

1. with respect to insurance required by Paragraphs 5.04.A.3 through 5.04.A.6 inclusive, include as additional insured (subject to any customary exclusion regarding professional liability) Owner and Engineer, and any other individuals or entities identified in the Supplementary Conditions, all of whom shall be listed as additional insureds, and include coverage for the respective officers, directors, partners, employees, agents, consultants and subcontractors of each and any of all such additional insureds, and the insurance afforded to these additional insureds shall provide primary coverage for all claims covered thereby;

2. include at least the specific coverages and be written for not less than the limits of liability provided in the Supplementary Conditions or required by Laws or Regulations, whichever is greater;

3. include completed operations insurance;

4. include contractual liability insurance covering Contractor's indemnity obligations under Paragraphs 6.11 and 6.20;

5. contain a provision or endorsement that the coverage afforded will not be canceled, materially changed or renewal refused until at least 30 days prior written notice has been given to Owner and Contractor and to each other additional insured identified in the Supplementary Conditions to whom a certificate of insurance has been issued (and the certificates of insurance furnished by the Contractor pursuant to Paragraph 5.03 will so provide);

6. remain in effect at least until final payment and at all times thereafter when Contractor may be correcting, removing, or replacing defective Work in accordance with Paragraph 13.07; and

7. with respect to completed operations insurance, and any insurance coverage written on a claims-made basis, remain in effect for at least two years after final payment.

a. Contractor shall furnish Owner and each other additional insured identified in the Supplementary Conditions, to whom a certificate of insurance has been issued, evidence satisfactory to Owner and any such additional insured of continuation of such insurance at final payment and one year thereafter.

#### 5.05 *Owner's Liability Insurance*

A. In addition to the insurance required to be provided by Contractor under Paragraph 5.04, Owner, at Owner's option, may purchase and maintain at Owner's expense Owner's own liability insurance as will protect Owner against claims which may arise from operations under the Contract Documents.

#### 5.06 *Property Insurance*

A. Unless otherwise provided in the Supplementary Conditions, Owner shall purchase and maintain property insurance upon the Work at the Site in the amount of the full replacement cost thereof (subject to such deductible amounts as may be provided in the Supplementary Conditions or required by Laws and Regulations). This insurance shall:

1. include the interests of Owner, Contractor, Subcontractors, and Engineer, and any other individuals or entities identified in the Supplementary Conditions, and the officers, directors, partners, employees, agents, consultants and subcontractors of each and any of them, each of whom is deemed to have an insurable interest and shall be listed as an insured or additional insured;

2. be written on a Builder's Risk "all-risk" or open peril or special causes of loss policy form that shall at least include insurance for physical loss or damage to the Work, temporary buildings, false work, and materials and equipment in transit, and shall insure against at least the following perils or causes of loss: fire, lightning, extended coverage, theft, vandalism and malicious mischief, earthquake, collapse, debris removal, demolition occasioned by enforcement of Laws and Regulations, water damage, (other than caused by flood) and such other perils or causes of loss as may be specifically required by the Supplementary Conditions;

3. include expenses incurred in the repair or replacement of any insured property (including but not limited to fees and charges of engineers and architects);

4. cover materials and equipment stored at the Site or at another location that was agreed to in writing by Owner prior to being incorporated in the Work, provided that such materials and equipment have been included in an Application for Payment recommended by Engineer;



5. allow for partial utilization of the Work by Owner;

6. include testing and startup; and

7. be maintained in effect until final payment is made unless otherwise agreed to in writing by Owner, Contractor, and Engineer with 30 days written notice to each other additional insured to whom a certificate of insurance has been issued.

B. Owner shall purchase and maintain such boiler and machinery insurance or additional property insurance as may be required by the Supplementary Conditions or Laws and Regulations which will include the interests of Owner, Contractor, Subcontractors, and Engineer, and any other individuals or entities identified in the Supplementary Conditions, and the officers, directors, partners, employees, agents, consultants and subcontractors of each and any of them, each of whom is deemed to have an insurable interest and shall be listed as an insured or additional insured.

C. All the policies of insurance (and the certificates or other evidence thereof) required to be purchased and maintained in accordance with Paragraph 5.06 will contain a provision or endorsement that the coverage afforded will not be canceled or materially changed or renewal refused until at least 30 days prior written notice has been given to Owner and Contractor and to each other additional insured to whom a certificate of insurance has been issued and will contain waiver provisions in accordance with Paragraph 5.07.

D. Owner shall not be responsible for purchasing and maintaining any property insurance specified in this Paragraph 5.06 to protect the interests of Contractor, Subcontractors, or others in the Work to the extent of any deductible amounts that are identified in the Supplementary Conditions. The risk of loss within such identified deductible amount will be borne by Contractor, Subcontractors, or others suffering any such loss, and if any of them wishes property insurance coverage within the limits of such amounts, each may purchase and maintain it at the purchaser's own expense.

E. If Contractor requests in writing that other special insurance be included in the property insurance policies provided under Paragraph 5.06, Owner shall, if possible, include such insurance, and the cost thereof will be charged to Contractor by appropriate Change Order. Prior to commencement of the Work at the Site, Owner shall in writing advise Contractor whether or not such other insurance has been procured by Owner.

#### 5.07 *Waiver of Rights*

A. Owner and Contractor intend that all policies purchased in accordance with Paragraph 5.06 will protect Owner, Contractor, Subcontractors, and Engineer, and all

other individuals or entities identified in the Supplementary Conditions to be listed as insureds or additional insureds (and the officers, directors, partners, employees, agents, consultants and subcontractors of each and any of them) in such policies and will provide primary coverage for all losses and damages caused by the perils or causes of loss covered thereby. All such policies shall contain provisions to the effect that in the event of payment of any loss or damage the insurers will have no rights of recovery against any of the insureds or additional insureds thereunder. Owner and Contractor waive all rights against each other and their respective officers, directors, partners, employees, agents, consultants and subcontractors of each and any of them for all losses and damages caused by, arising out of or resulting from any of the perils or causes of loss covered by such policies and any other property insurance applicable to the Work; and, in addition, waive all such rights against Subcontractors, and Engineer, and all other individuals or entities identified in the Supplementary Conditions to be listed as insured or additional insured (and the officers, directors, partners, employees, agents, consultants and subcontractors of each and any of them) under such policies for losses and damages so caused. None of the above waivers shall extend to the rights that any party making such waiver may have to the proceeds of insurance held by Owner as trustee or otherwise payable under any policy so issued.

B. Owner waives all rights against Contractor, Subcontractors, and Engineer, and the officers, directors, partners, employees, agents, consultants and subcontractors of each and any of them for:

1. loss due to business interruption, loss of use, or other consequential loss extending beyond direct physical loss or damage to Owner's property or the Work caused by, arising out of, or resulting from fire or other perils whether or not insured by Owner; and

2. loss or damage to the completed Project or part thereof caused by, arising out of, or resulting from fire or other insured peril or cause of loss covered by any property insurance maintained on the completed Project or part thereof by Owner during partial utilization pursuant to Paragraph 14.05, after Substantial Completion pursuant to Paragraph 14.04, or after final payment pursuant to Paragraph 14.07.

C. Any insurance policy maintained by Owner covering any loss, damage or consequential loss referred to in Paragraph 5.07.B shall contain provisions to the effect that in the event of payment of any such loss, damage, or consequential loss, the insurers will have no rights of recovery against Contractor, Subcontractors, or Engineer, and the officers, directors, partners, employees, agents, consultants and subcontractors of each and any of them.

#### 5.08 *Receipt and Application of Insurance Proceeds*

A. Any insured loss under the policies of insurance required by Paragraph 5.06 will be adjusted with Owner and made payable to Owner as fiduciary for the insureds, as their interests may appear, subject to the requirements of any applicable mortgage clause and of Paragraph 5.08.B. Owner shall deposit in a separate account any money so received and shall distribute it in accordance with such agreement as the parties in interest may reach. If no other special agreement is reached, the damaged Work shall be repaired or replaced, the moneys so received applied on account thereof, and the Work and the cost thereof covered by an appropriate Change Order .

B. Owner as fiduciary shall have power to adjust and settle any loss with the insurers unless one of the parties in interest shall object in writing within 15 days after the occurrence of loss to Owner's exercise of this power. If such objection be made, Owner as fiduciary shall make settlement with the insurers in accordance with such agreement as the parties in interest may reach. If no such agreement among the parties in interest is reached, Owner as fiduciary shall adjust and settle the loss with the insurers and, if required in writing by any party in interest, Owner as fiduciary shall give bond for the proper performance of such duties.

#### 5.09 *Acceptance of Bonds and Insurance; Option to Replace*

A. If either Owner or Contractor has any objection to the coverage afforded by or other provisions of the bonds or insurance required to be purchased and maintained by the other party in accordance with Article 5 on the basis of non-conformance with the Contract Documents, the objecting party shall so notify the other party in writing within 10 days after receipt of the certificates (or other evidence requested) required by Paragraph 2.01.B. Owner and Contractor shall each provide to the other such additional information in respect of insurance provided as the other may reasonably request. If either party does not purchase or maintain all of the bonds and insurance required of such party by the Contract Documents, such party shall notify the other party in writing of such failure to purchase prior to the start of the Work, or of such failure to maintain prior to any change in the required coverage. Without prejudice to any other right or remedy, the other party may elect to obtain equivalent bonds or insurance to protect such other party's interests at the expense of the party who was required to provide such coverage, and a Change Order shall be issued to adjust the Contract Price accordingly.

#### 5.10 *Partial Utilization, Acknowledgment of Property Insurer*

A. If Owner finds it necessary to occupy or use a portion or portions of the Work prior to Substantial Completion of all the Work as provided in Paragraph 14.05, no such use or occupancy shall commence before

the insurers providing the property insurance pursuant to Paragraph 5.06 have acknowledged notice thereof and in writing effected any changes in coverage necessitated thereby. The insurers providing the property insurance shall consent by endorsement on the policy or policies, but the property insurance shall not be canceled or permitted to lapse on account of any such partial use or occupancy.

---

### ARTICLE 6 - CONTRACTOR'S RESPONSIBILITIES

---

#### 6.01 *Supervision and Superintendence*

A. Contractor shall supervise, inspect, and direct the Work competently and efficiently, devoting such attention thereto and applying such skills and expertise as may be necessary to perform the Work in accordance with the Contract Documents. Contractor shall be solely responsible for the means, methods, techniques, sequences, and procedures of construction. Contractor shall not be responsible for the negligence of Owner or Engineer in the design or specification of a specific means, method, technique, sequence, or procedure of construction which is shown or indicated in and expressly required by the Contract Documents.

B. At all times during the progress of the Work, Contractor shall assign a competent resident superintendent who shall not be replaced without written notice to Owner and Engineer except under extraordinary circumstances. The superintendent will be Contractor's representative at the Site and shall have authority to act on behalf of Contractor. All communications given to or received from the superintendent shall be binding on Contractor.

#### 6.02 *Labor; Working Hours*

A. Contractor shall provide competent, suitably qualified personnel to survey and lay out the Work and perform construction as required by the Contract Documents. Contractor shall at all times maintain good discipline and order at the Site.

B. Except as otherwise required for the safety or protection of persons or the Work or property at the Site or adjacent thereto, and except as otherwise stated in the Contract Documents, all Work at the Site shall be performed during regular working hours. Contractor will not permit the performance of Work on a Saturday, Sunday, or any legal holiday without Owner's written consent (which will not be unreasonably withheld) given after prior written notice to Engineer.

#### 6.03 *Services, Materials, and Equipment*

A. Unless otherwise specified in the Contract Documents, Contractor shall provide and assume full responsibility for all services, materials, equipment, labor, transportation, construction equipment and machinery,

tools, appliances, fuel, power, light, heat, telephone, water, sanitary facilities, temporary facilities, and all other facilities and incidentals necessary for the performance, testing, start-up, and completion of the Work.

B. All materials and equipment incorporated into the Work shall be as specified or, if not specified, shall be of good quality and new, except as otherwise provided in the Contract Documents. All special warranties and guarantees required by the Specifications shall expressly run to the benefit of Owner. If required by Engineer, Contractor shall furnish satisfactory evidence (including reports of required tests) as to the source, kind, and quality of materials and equipment.

C. All materials and equipment shall be stored, applied, installed, connected, erected, protected, used, cleaned, and conditioned in accordance with instructions of the applicable Supplier, except as otherwise may be provided in the Contract Documents.

#### 6.04 *Progress Schedule*

A. Contractor shall adhere to the Progress Schedule established in accordance with Paragraph 2.07 as it may be adjusted from time to time as provided below.

1. Contractor shall submit to Engineer for acceptance (to the extent indicated in Paragraph 2.07) proposed adjustments in the Progress Schedule that will not result in changing the Contract Times. Such adjustments will comply with any provisions of the General Requirements applicable thereto.

2. Proposed adjustments in the Progress Schedule that will change the Contract Times shall be submitted in accordance with the requirements of Article 12. Adjustments in Contract Times may only be made by a Change Order.

#### 6.05 *Substitutes and "Or-Equals"*

A. Whenever an item of material or equipment is specified or described in the Contract Documents by using the name of a proprietary item or the name of a particular Supplier, the specification or description is intended to establish the type, function, appearance, and quality required. Unless the specification or description contains or is followed by words reading that no like, equivalent, or "or-equal" item or no substitution is permitted, other items of material or equipment or material or equipment of other Suppliers may be submitted to Engineer for review under the circumstances described below.

1. "*Or-Equal*" Items: If in Engineer's sole discretion an item of material or equipment proposed by Contractor is functionally equal to that named and sufficiently similar so that no change in related Work will be required, it may be considered by Engineer as an "or-equal" item, in which case review and approval of the

proposed item may, in Engineer's sole discretion, be accomplished without compliance with some or all of the requirements for approval of proposed substitute items. For the purposes of this Paragraph 6.05.A.1, a proposed item of material or equipment will be considered functionally equal to an item so named if:

a. in the exercise of reasonable judgment Engineer determines that:

1) it is at least equal in materials of construction, quality, durability, appearance, strength, and design characteristics;

2) it will reliably perform at least equally well the function and achieve the results imposed by the design concept of the completed Project as a functioning whole,

3) it has a proven record of performance and availability of responsive service; and

b. Contractor certifies that, if approved and incorporated into the Work:

1) there will be no increase in cost to the Owner or increase in Contract Times, and

2) it will conform substantially to the detailed requirements of the item named in the Contract Documents.

#### 2. Substitute Items

a. If in Engineer's sole discretion an item of material or equipment proposed by Contractor does not qualify as an "or-equal" item under Paragraph 6.05.A.1, it will be considered a proposed substitute item.

b. Contractor shall submit sufficient information as provided below to allow Engineer to determine that the item of material or equipment proposed is essentially equivalent to that named and an acceptable substitute therefor. Requests for review of proposed substitute items of material or equipment will not be accepted by Engineer from anyone other than Contractor.

c. The requirements for review by Engineer will be as set forth in Paragraph 6.05.A.2.d, as supplemented in the General Requirements and as Engineer may decide is appropriate under the circumstances.

d. Contractor shall make written application to Engineer for review of a proposed substitute

item of material or equipment that Contractor seeks to furnish or use. The application:

1) shall certify that the proposed substitute item will:

- a) perform adequately the functions and achieve the results called for by the general design,
- b) be similar in substance to that specified, and
- c) be suited to the same use as that specified;

2) will state:

- a) the extent, if any, to which the use of the proposed substitute item will prejudice Contractor's achievement of Substantial Completion on time;
- b) whether or not use of the proposed substitute item in the Work will require a change in any of the Contract Documents (or in the provisions of any other direct contract with Owner for other work on the Project) to adapt the design to the proposed substitute item; and
- c) whether or not incorporation or use of the proposed substitute item in connection with the Work is subject to payment of any license fee or royalty;

3) will identify:

- a) all variations of the proposed substitute item from that specified, and
- b) available engineering, sales, maintenance, repair, and replacement services;

4) and shall contain an itemized estimate of all costs or credits that will result directly or indirectly from use of such substitute item, including costs of redesign and claims of other contractors affected by any resulting change,

**B. Substitute Construction Methods or Procedures:** If a specific means, method, technique, sequence, or procedure of construction is expressly required by the Contract Documents, Contractor may furnish or utilize a substitute means, method, technique, sequence, or procedure of construction approved by Engineer. Contractor shall submit sufficient information to allow Engineer, in Engineer's sole discretion, to determine that the substitute proposed is equivalent to that expressly

called for by the Contract Documents. The requirements for review by Engineer will be similar to those provided in Paragraph 6.05.A.2.

**C. Engineer's Evaluation:** Engineer will be allowed a reasonable time within which to evaluate each proposal or submittal made pursuant to Paragraphs 6.05.A and 6.05.B. Engineer may require Contractor to furnish additional data about the proposed substitute item. Engineer will be the sole judge of acceptability. No "or equal" or substitute will be ordered, installed or utilized until Engineer's review is complete, which will be evidenced by either a Change Order for a substitute or an approved Shop Drawing for an "or equal." Engineer will advise Contractor in writing of any negative determination.

**D. Special Guarantee:** Owner may require Contractor to furnish at Contractor's expense a special performance guarantee or other surety with respect to any substitute.

**E. Engineer's Cost Reimbursement:** Engineer will record Engineer's costs in evaluating a substitute proposed or submitted by Contractor pursuant to Paragraphs 6.05.A.2 and 6.05.B. Whether or not Engineer approves a substitute item so proposed or submitted by Contractor, Contractor shall reimburse Owner for the charges of Engineer for evaluating each such proposed substitute. Contractor shall also reimburse Owner for the charges of Engineer for making changes in the Contract Documents (or in the provisions of any other direct contract with Owner) resulting from the acceptance of each proposed substitute.

**F. Contractor's Expense:** Contractor shall provide all data in support of any proposed substitute or "or-equal" at Contractor's expense.

#### 6.06 Concerning Subcontractors, Suppliers, and Others

A. Contractor shall not employ any Subcontractor, Supplier, or other individual or entity (including those acceptable to Owner as indicated in Paragraph 6.06.B), whether initially or as a replacement, against whom Owner may have reasonable objection. Contractor shall not be required to employ any Subcontractor, Supplier, or other individual or entity to furnish or perform any of the Work against whom Contractor has reasonable objection.

B. If the Supplementary Conditions require the identity of certain Subcontractors, Suppliers, or other individuals or entities to be submitted to Owner in advance for acceptance by Owner by a specified date prior to the Effective Date of the Agreement, and if Contractor has submitted a list thereof in accordance with the Supplementary Conditions, Owner's acceptance (either in writing or by failing to make written objection thereto by the date indicated for acceptance or objection in the Bidding Documents or the Contract Documents) of any such

Subcontractor, Supplier, or other individual or entity so identified may be revoked on the basis of reasonable objection after due investigation. Contractor shall submit an acceptable replacement for the rejected Subcontractor, Supplier, or other individual or entity, and the Contract Price will be adjusted by the difference in the cost occasioned by such replacement, and an appropriate Change Order will be issued. No acceptance by Owner of any such Subcontractor, Supplier, or other individual or entity, whether initially or as a replacement, shall constitute a waiver of any right of Owner or Engineer to reject defective Work.

C. Contractor shall be fully responsible to Owner and Engineer for all acts and omissions of the Subcontractors, Suppliers, and other individuals or entities performing or furnishing any of the Work just as Contractor is responsible for Contractor's own acts and omissions. Nothing in the Contract Documents:

1. shall create for the benefit of any such Subcontractor, Supplier, or other individual or entity any contractual relationship between Owner or Engineer and any such Subcontractor, Supplier or other individual or entity, nor

2. shall anything in the Contract Documents create any obligation on the part of Owner or Engineer to pay or to see to the payment of any moneys due any such Subcontractor, Supplier, or other individual or entity except as may otherwise be required by Laws and Regulations.

D. Contractor shall be solely responsible for scheduling and coordinating the Work of Subcontractors, Suppliers, and other individuals or entities performing or furnishing any of the Work under a direct or indirect contract with Contractor.

E. Contractor shall require all Subcontractors, Suppliers, and such other individuals or entities performing or furnishing any of the Work to communicate with Engineer through Contractor.

F. The divisions and sections of the Specifications and the identifications of any Drawings shall not control Contractor in dividing the Work among Subcontractors or Suppliers or delineating the Work to be performed by any specific trade.

G. All Work performed for Contractor by a Subcontractor or Supplier will be pursuant to an appropriate agreement between Contractor and the Subcontractor or Supplier which specifically binds the Subcontractor or Supplier to the applicable terms and conditions of the Contract Documents for the benefit of Owner and Engineer. Whenever any such agreement is with a Subcontractor or Supplier who is listed as an additional insured on the property insurance provided in Paragraph 5.06, the agreement between the Contractor and

the Subcontractor or Supplier will contain provisions whereby the Subcontractor or Supplier waives all rights against Owner, Contractor, and Engineer, and all other individuals or entities identified in the Supplementary Conditions to be listed as insureds or additional insureds (and the officers, directors, partners, employees, agents, consultants and subcontractors of each and any of them) for all losses and damages caused by, arising out of, relating to, or resulting from any of the perils or causes of loss covered by such policies and any other property insurance applicable to the Work. If the insurers on any such policies require separate waiver forms to be signed by any Subcontractor or Supplier, Contractor will obtain the same.

#### 6.07 *Patent Fees and Royalties*

A. Contractor shall pay all license fees and royalties and assume all costs incident to the use in the performance of the Work or the incorporation in the Work of any invention, design, process, product, or device which is the subject of patent rights or copyrights held by others. If a particular invention, design, process, product, or device is specified in the Contract Documents for use in the performance of the Work and if to the actual knowledge of Owner or Engineer its use is subject to patent rights or copyrights calling for the payment of any license fee or royalty to others, the existence of such rights shall be disclosed by Owner in the Contract Documents.

B. To the fullest extent permitted by Laws and Regulations, Contractor shall indemnify and hold harmless Owner and Engineer, and the officers, directors, partners, employees, agents, consultants and subcontractors of each and any of them from and against all claims, costs, losses, and damages (including but not limited to all fees and charges of engineers, architects, attorneys, and other professionals and all court or arbitration or other dispute resolution costs) arising out of or relating to any infringement of patent rights or copyrights incident to the use in the performance of the Work or resulting from the incorporation in the Work of any invention, design, process, product, or device not specified in the Contract Documents.

#### 6.08 *Permits*

A. Unless otherwise provided in the Supplementary Conditions, Contractor shall obtain and pay for all construction permits and licenses. Owner shall assist Contractor, when necessary, in obtaining such permits and licenses. Contractor shall pay all governmental charges and inspection fees necessary for the prosecution of the Work which are applicable at the time of opening of Bids, or, if there are no Bids, on the Effective Date of the Agreement. Owner shall pay all charges of utility owners for connections for providing permanent service to the Work.

#### 6.09 *Laws and Regulations*

A. Contractor shall give all notices required by and shall comply with all Laws and Regulations applicable to the performance of the Work. Except where otherwise

expressly required by applicable Laws and Regulations, neither Owner nor Engineer shall be responsible for monitoring Contractor's compliance with any Laws or Regulations.

B. If Contractor performs any Work knowing or having reason to know that it is contrary to Laws or Regulations, Contractor shall bear all claims, costs, losses, and damages (including but not limited to all fees and charges of engineers, architects, attorneys, and other professionals and all court or arbitration or other dispute resolution costs) arising out of or relating to such Work. However, it shall not be Contractor's primary responsibility to make certain that the Specifications and Drawings are in accordance with Laws and Regulations, but this shall not relieve Contractor of Contractor's obligations under Paragraph 3.03.

C. Changes in Laws or Regulations not known at the time of opening of Bids (or, on the Effective Date of the Agreement if there were no Bids) having an effect on the cost or time of performance of the Work shall be the subject of an adjustment in Contract Price or Contract Times. If Owner and Contractor are unable to agree on entitlement to or on the amount or extent, if any, of any such adjustment, a Claim may be made therefor as provided in Paragraph 10.05.

#### 6.10 Taxes

A. Contractor shall pay all sales, consumer, use, and other similar taxes required to be paid by Contractor in accordance with the Laws and Regulations of the place of the Project which are applicable during the performance of the Work.

#### 6.11 Use of Site and Other Areas

##### A. Limitation on Use of Site and Other Areas

1. Contractor shall confine construction equipment, the storage of materials and equipment, and the operations of workers to the Site and other areas permitted by Laws and Regulations, and shall not unreasonably encumber the Site and other areas with construction equipment or other materials or equipment. Contractor shall assume full responsibility for any damage to any such land or area, or to the owner or occupant thereof, or of any adjacent land or areas resulting from the performance of the Work.

2. Should any claim be made by any such owner or occupant because of the performance of the Work, Contractor shall promptly settle with such other party by negotiation or otherwise resolve the claim by arbitration or other dispute resolution proceeding or at law.

3. To the fullest extent permitted by Laws and Regulations, Contractor shall indemnify and hold harmless Owner and Engineer, and the officers, directors, partners,

employees, agents, consultants and subcontractors of each and any of them from and against all claims, costs, losses, and damages (including but not limited to all fees and charges of engineers, architects, attorneys, and other professionals and all court or arbitration or other dispute resolution costs) arising out of or relating to any claim or action, legal or equitable, brought by any such owner or occupant against Owner, Engineer, or any other party indemnified hereunder to the extent caused by or based upon Contractor's performance of the Work.

B. *Removal of Debris During Performance of the Work:* During the progress of the Work Contractor shall keep the Site and other areas free from accumulations of waste materials, rubbish, and other debris. Removal and disposal of such waste materials, rubbish, and other debris shall conform to applicable Laws and Regulations.

C. *Cleaning:* Prior to Substantial Completion of the Work Contractor shall clean the Site and the Work and make it ready for utilization by Owner. At the completion of the Work Contractor shall remove from the Site all tools, appliances, construction equipment and machinery, and surplus materials and shall restore to original condition all property not designated for alteration by the Contract Documents.

D. *Loading Structures:* Contractor shall not load nor permit any part of any structure to be loaded in any manner that will endanger the structure, nor shall Contractor subject any part of the Work or adjacent property to stresses or pressures that will endanger it.

#### 6.12 Record Documents

A. Contractor shall maintain in a safe place at the Site one record copy of all Drawings, Specifications, Addenda, Change Orders, Work Change Directives, Field Orders, and written interpretations and clarifications in good order and annotated to show changes made during construction. These record documents together with all approved Samples and a counterpart of all approved Shop Drawings will be available to Engineer for reference. Upon completion of the Work, these record documents, Samples, and Shop Drawings will be delivered to Engineer for Owner.

#### 6.13 Safety and Protection

A. Contractor shall be solely responsible for initiating, maintaining and supervising all safety precautions and programs in connection with the Work. Contractor shall take all necessary precautions for the safety of, and shall provide the necessary protection to prevent damage, injury or loss to:

1. all persons on the Site or who may be affected by the Work;

2. all the Work and materials and equipment to be incorporated therein, whether in storage on or off the Site; and

3. other property at the Site or adjacent thereto, including trees, shrubs, lawns, walks, pavements, roadways, structures, utilities, and Underground Facilities not designated for removal, relocation, or replacement in the course of construction.

B. Contractor shall comply with all applicable Laws and Regulations relating to the safety of persons or property, or to the protection of persons or property from damage, injury, or loss; and shall erect and maintain all necessary safeguards for such safety and protection. Contractor shall notify owners of adjacent property and of Underground Facilities and other utility owners when prosecution of the Work may affect them, and shall cooperate with them in the protection, removal, relocation, and replacement of their property.

C. All damage, injury, or loss to any property referred to in Paragraph 6.13.A.2 or 6.13.A.3 caused, directly or indirectly, in whole or in part, by Contractor, any Subcontractor, Supplier, or any other individual or entity directly or indirectly employed by any of them to perform any of the Work, or anyone for whose acts any of them may be liable, shall be remedied by Contractor (except damage or loss attributable to the fault of Drawings or Specifications or to the acts or omissions of Owner or Engineer or , or anyone employed by any of them, or anyone for whose acts any of them may be liable, and not attributable, directly or indirectly, in whole or in part, to the fault or negligence of Contractor or any Subcontractor, Supplier, or other individual or entity directly or indirectly employed by any of them).

D. Contractor's duties and responsibilities for safety and for protection of the Work shall continue until such time as all the Work is completed and Engineer has issued a notice to Owner and Contractor in accordance with Paragraph 14.07.B that the Work is acceptable (except as otherwise expressly provided in connection with Substantial Completion).

#### 6.14 *Safety Representative*

A. Contractor shall designate a qualified and experienced safety representative at the Site whose duties and responsibilities shall be the prevention of accidents and the maintaining and supervising of safety precautions and programs.

#### 6.15 *Hazard Communication Programs*

A. Contractor shall be responsible for coordinating any exchange of material safety data sheets or other hazard communication information required to be made available to or exchanged between or among employers at the Site in accordance with Laws or Regulations.

#### 6.16 *Emergencies*

A. In emergencies affecting the safety or protection of persons or the Work or property at the Site or adjacent thereto, Contractor is obligated to act to prevent threatened damage, injury, or loss. Contractor shall give Engineer prompt written notice if Contractor believes that any significant changes in the Work or variations from the Contract Documents have been caused thereby or are required as a result thereof. If Engineer determines that a change in the Contract Documents is required because of the action taken by Contractor in response to such an emergency, a Work Change Directive or Change Order will be issued.

#### 6.17 *Shop Drawings and Samples*

A. Contractor shall submit Shop Drawings and Samples to Engineer for review and approval in accordance with the acceptable Schedule of Submittals (as required by Paragraph 2.07). Each submittal will be identified as Engineer may require.

##### 1. Shop Drawings

a. Submit number of copies specified in the General Requirements.

b. Data shown on the Shop Drawings will be complete with respect to quantities, dimensions, specified performance and design criteria, materials, and similar data to show Engineer the services, materials, and equipment Contractor proposes to provide and to enable Engineer to review the information for the limited purposes required by Paragraph 6.17.D.

2. *Samples*: Contractor shall also submit Samples to Engineer for review and approval in accordance with the acceptable schedule of Shop Drawings and Sample submittals.

a. Submit number of Samples specified in the Specifications.

b. Clearly identify each Sample as to material, Supplier, pertinent data such as catalog numbers, the use for which intended and other data as Engineer may require to enable Engineer to review the submittal for the limited purposes required by Paragraph 6.17.D.

B. Where a Shop Drawing or Sample is required by the Contract Documents or the Schedule of Submittals , any related Work performed prior to Engineer's review and approval of the pertinent submittal will be at the sole expense and responsibility of Contractor.

### C. Submittal Procedures

1. Before submitting each Shop Drawing or Sample, Contractor shall have determined and verified:

- a. all field measurements, quantities, dimensions, specified performance and design criteria, installation requirements, materials, catalog numbers, and similar information with respect thereto;
- b. the suitability of all materials with respect to intended use, fabrication, shipping, handling, storage, assembly, and installation pertaining to the performance of the Work;
- c. all information relative to Contractor's responsibilities for means, methods, techniques, sequences, and procedures of construction, and safety precautions and programs incident thereto; and
- d. shall also have reviewed and coordinated each Shop Drawing or Sample with other Shop Drawings and Samples and with the requirements of the Work and the Contract Documents.

2. Each submittal shall bear a stamp or specific written certification that Contractor has satisfied Contractor's obligations under the Contract Documents with respect to Contractor's review and approval of that submittal.

3. With each submittal, Contractor shall give Engineer specific written notice of any variations, that the Shop Drawing or Sample may have from the requirements of the Contract Documents. This notice shall be both a written communication separate from the Shop Drawing's or Sample Submittal; and, in addition, by a specific notation made on each Shop Drawing or Sample submitted to Engineer for review and approval of each such variation.

### D. Engineer's Review

1. Engineer will provide timely review of Shop Drawings and Samples in accordance with the Schedule of Submittals acceptable to Engineer. Engineer's review and approval will be only to determine if the items covered by the submittals will, after installation or incorporation in the Work, conform to the information given in the Contract Documents and be compatible with the design concept of the completed Project as a functioning whole as indicated by the Contract Documents.

2. Engineer's review and approval will not extend to means, methods, techniques, sequences, or procedures of construction (except where a particular

means, method, technique, sequence, or procedure of construction is specifically and expressly called for by the Contract Documents) or to safety precautions or programs incident thereto. The review and approval of a separate item as such will not indicate approval of the assembly in which the item functions.

3. Engineer's review and approval shall not relieve Contractor from responsibility for any variation from the requirements of the Contract Documents unless Contractor has complied with the requirements of Paragraph 6.17.C.3 and Engineer has given written approval of each such variation by specific written notation thereof incorporated in or accompanying the Shop Drawing or Sample. Engineer's review and approval shall not relieve Contractor from responsibility for complying with the requirements of Paragraph 6.17.C.1.

### E. Resubmittal Procedures

1. Contractor shall make corrections required by Engineer and shall return the required number of corrected copies of Shop Drawings and submit, as required, new Samples for review and approval. Contractor shall direct specific attention in writing to revisions other than the corrections called for by Engineer on previous submittals.

### 6.18 Continuing the Work

A. Contractor shall carry on the Work and adhere to the Progress Schedule during all disputes or disagreements with Owner. No Work shall be delayed or postponed pending resolution of any disputes or disagreements, except as permitted by Paragraph 15.04 or as Owner and Contractor may otherwise agree in writing.

### 6.19 Contractor's General Warranty and Guarantee

A. Contractor warrants and guarantees to Owner that all Work will be in accordance with the Contract Documents and will not be defective. Engineer and its Related Entities shall be entitled to rely on representation of Contractor's warranty and guarantee.

B. Contractor's warranty and guarantee hereunder excludes defects or damage caused by:

1. abuse, modification, or improper maintenance or operation by persons other than Contractor, Subcontractors, Suppliers, or any other individual or entity for whom Contractor is responsible; or

2. normal wear and tear under normal usage.

C. Contractor's obligation to perform and complete the Work in accordance with the Contract Documents shall be absolute. None of the following will constitute an acceptance of Work that is not in accordance



with the Contract Documents or a release of Contractor's obligation to perform the Work in accordance with the Contract Documents:

1. observations by Engineer;
2. recommendation by Engineer or payment by Owner of any progress or final payment;
3. the issuance of a certificate of Substantial Completion by Engineer or any payment related thereto by Owner;
4. use or occupancy of the Work or any part thereof by Owner;
5. any review and approval of a Shop Drawing or Sample submittal or the issuance of a notice of acceptability by Engineer;
6. any inspection, test, or approval by others; or
7. any correction of defective Work by Owner.

#### 6.20 *Indemnification*

A. To the fullest extent permitted by Laws and Regulations, Contractor shall indemnify and hold harmless Owner and Engineer, and the officers, directors, partners, employees, agents, consultants and subcontractors of each and any of them from and against all claims, costs, losses, and damages (including but not limited to all fees and charges of engineers, architects, attorneys, and other professionals and all court or arbitration or other dispute resolution costs) arising out of or relating to the performance of the Work, provided that any such claim, cost, loss, or damage is attributable to bodily injury, sickness, disease, or death, or to injury to or destruction of tangible property (other than the Work itself), including the loss of use resulting therefrom but only to the extent caused by any negligent act or omission of Contractor, any Subcontractor, any Supplier, or any individual or entity directly or indirectly employed by any of them to perform any of the Work or anyone for whose acts any of them may be liable

B. In any and all claims against Owner or Engineer or any of their respective consultants, agents, officers, directors, partners, or employees by any employee (or the survivor or personal representative of such employee) of Contractor, any Subcontractor, any Supplier, or any individual or entity directly or indirectly employed by any of them to perform any of the Work, or anyone for whose acts any of them may be liable, the indemnification obligation under Paragraph 6.20.A shall not be limited in any way by any limitation on the amount or type of damages, compensation, or benefits payable by or for Contractor or any such Subcontractor, Supplier, or other individual or entity under workers' compensation acts, disability benefit acts, or other employee benefit acts.

C. The indemnification obligations of Contractor under Paragraph 6.20.A shall not extend to the liability of Engineer and Engineer's officers, directors, partners, employees, agents, consultants and subcontractors arising out of:

1. the preparation or approval of, or the failure to prepare or approve, maps, Drawings, opinions, reports, surveys, Change Orders, designs, or Specifications; or
2. giving directions or instructions, or failing to give them, if that is the primary cause of the injury or damage.

#### 6.21 *Delegation of Professional Design Services*

A. Contractor will not be required to provide professional design services unless such services are specifically required by the Contract Documents for a portion of the Work or unless such services are required to carry out Contractor's responsibilities for construction means, methods, techniques, sequences and procedures. Contractor shall not be required to provide professional services in violation of applicable law.

B. If professional design services or certifications by a design professional related to systems, materials or equipment are specifically required of Contractor by the Contract Documents, Owner and Engineer will specify all performance and design criteria that such services must satisfy. Contractor shall cause such services or certifications to be provided by a properly licensed professional, whose signature and seal shall appear on all drawings, calculations, specifications, certifications, Shop Drawings and other submittals prepared by such professional. Shop Drawings and other submittals related to the Work designed or certified by such professional, if prepared by others, shall bear such professional's written approval when submitted to Engineer.

C. Owner and Engineer shall be entitled to rely upon the adequacy, accuracy and completeness of the services, certifications or approvals performed by such design professionals, provided Owner and Engineer have specified to Contractor all performance and design criteria that such services must satisfy.

D. Pursuant to this Paragraph 6.21, Engineer's review and approval of design calculations and design drawings will be only for the limited purpose of checking for conformance with performance and design criteria given and the design concept expressed in the Contract Documents. Engineer's review and approval of Shop Drawings and other submittals (except design calculations and design drawings) will be only for the purpose stated in Paragraph 6.17.D.1.

E. Contractor shall not be responsible for the adequacy of the performance or design criteria required by the Contract Documents.

## ARTICLE 7 - OTHER WORK AT THE SITE

---

### 7.01 *Related Work at Site*

A. Owner may perform other work related to the Project at the Site with Owner's employees, or via other direct contracts therefor, or have other work performed by utility owners. If such other work is not noted in the Contract Documents, then:

1. written notice thereof will be given to Contractor prior to starting any such other work; and
2. if Owner and Contractor are unable to agree on entitlement to or on the amount or extent, if any, of any adjustment in the Contract Price or Contract Times that should be allowed as a result of such other work, a Claim may be made therefor as provided in Paragraph 10.05.

B. Contractor shall afford each other contractor who is a party to such a direct contract, each utility owner and Owner, if Owner is performing other work with Owner's employees, proper and safe access to the Site, a reasonable opportunity for the introduction and storage of materials and equipment and the execution of such other work, and shall properly coordinate the Work with theirs. Contractor shall do all cutting, fitting, and patching of the Work that may be required to properly connect or otherwise make its several parts come together and properly integrate with such other work. Contractor shall not endanger any work of others by cutting, excavating, or otherwise altering their work and will only cut or alter their work with the written consent of Engineer and the others whose work will be affected. The duties and responsibilities of Contractor under this Paragraph are for the benefit of such utility owners and other contractors to the extent that there are comparable provisions for the benefit of Contractor in said direct contracts between Owner and such utility owners and other contractors.

C. If the proper execution or results of any part of Contractor's Work depends upon work performed by others under this Article 7, Contractor shall inspect such other work and promptly report to Engineer in writing any delays, defects, or deficiencies in such other work that render it unavailable or unsuitable for the proper execution and results of Contractor's Work. Contractor's failure to so report will constitute an acceptance of such other work as fit and proper for integration with Contractor's Work except for latent defects and deficiencies in such other work.

### 7.02 *Coordination*

A. If Owner intends to contract with others for the performance of other work on the Project at the Site, the following will be set forth in Supplementary Conditions:

1. the individual or entity who will have authority and responsibility for coordination of the activities among the various contractors will be identified;
2. the specific matters to be covered by such authority and responsibility will be itemized; and
3. the extent of such authority and responsibilities will be provided.

B. Unless otherwise provided in the Supplementary Conditions, Owner shall have sole authority and responsibility for such coordination.

### 7.03 *Legal Relationships*

A. Paragraphs 7.01.A and 7.02 are not applicable for utilities not under the control of Owner.

B. Each other direct contract of Owner under Paragraph 7.01.A shall provide that the other contractor is liable to Owner and Contractor for the reasonable direct delay and disruption costs incurred by Contractor as a result of the other contractor's actions or inactions.

C. Contractor shall be liable to Owner and any other contractor for the reasonable direct delay and disruption costs incurred by such other contractor as a result of Contractor's action or inactions.

## ARTICLE 8 - OWNER'S RESPONSIBILITIES

---

### 8.01 *Communications to Contractor*

A. Except as otherwise provided in these General Conditions, Owner shall issue all communications to Contractor through Engineer.

### 8.02 *Replacement of Engineer*

A. In case of termination of the employment of Engineer, Owner shall appoint an engineer to whom Contractor makes no reasonable objection, whose status under the Contract Documents shall be that of the former Engineer.

### 8.03 *Furnish Data*

A. Owner shall promptly furnish the data required of Owner under the Contract Documents.

8.04 *Pay When Due*

A. Owner shall make payments to Contractor when they are due as provided in Paragraphs 14.02.C and 14.07.C.

8.05 *Lands and Easements; Reports and Tests*

A. Owner's duties in respect of providing lands and easements and providing engineering surveys to establish reference points are set forth in Paragraphs 4.01 and 4.05. Paragraph 4.02 refers to Owner's identifying and making available to Contractor copies of reports of explorations and tests of subsurface conditions and drawings of physical conditions in or relating to existing surface or subsurface structures at or contiguous to the Site that have been utilized by Engineer in preparing the Contract Documents.

8.06 *Insurance*

A. Owner's responsibilities, if any, in respect of purchasing and maintaining liability and property insurance are set forth in Article 5.

8.07 *Change Orders*

A. Owner is obligated to execute Change Orders as indicated in Paragraph 10.03.

8.08 *Inspections, Tests, and Approvals*

A. Owner's responsibility in respect to certain inspections, tests, and approvals is set forth in Paragraph 13.03.B.

8.09 *Limitations on Owner's Responsibilities*

A. The Owner shall not supervise, direct, or have control or authority over, nor be responsible for, Contractor's means, methods, techniques, sequences, or procedures of construction, or the safety precautions and programs incident thereto, or for any failure of Contractor to comply with Laws and Regulations applicable to the performance of the Work. Owner will not be responsible for Contractor's failure to perform the Work in accordance with the Contract Documents.

8.10 *Undisclosed Hazardous Environmental Condition*

A. Owner's responsibility in respect to an undisclosed Hazardous Environmental Condition is set forth in Paragraph 4.06.

8.11 *Evidence of Financial Arrangements*

A. If and to the extent Owner has agreed to furnish Contractor reasonable evidence that financial arrangements have been made to satisfy Owner's obligations under the Contract Documents, Owner's

responsibility in respect thereof will be as set forth in the Supplementary Conditions.

ARTICLE 9 - ENGINEER'S STATUS DURING CONSTRUCTION

---

9.01 *Owner's Representative*

A. Engineer will be Owner's representative during the construction period. The duties and responsibilities and the limitations of authority of Engineer as Owner's representative during construction are set forth in the Contract Documents and will not be changed without written consent of Owner and Engineer.

9.02 *Visits to Site*

A. Engineer will make visits to the Site at intervals appropriate to the various stages of construction as Engineer deems necessary in order to observe as an experienced and qualified design professional the progress that has been made and the quality of the various aspects of Contractor's executed Work. Based on information obtained during such visits and observations, Engineer, for the benefit of Owner, will determine, in general, if the Work is proceeding in accordance with the Contract Documents. Engineer will not be required to make exhaustive or continuous inspections on the Site to check the quality or quantity of the Work. Engineer's efforts will be directed toward providing for Owner a greater degree of confidence that the completed Work will conform generally to the Contract Documents. On the basis of such visits and observations, Engineer will keep Owner informed of the progress of the Work and will endeavor to guard Owner against defective Work.

B. Engineer's visits and observations are subject to all the limitations on Engineer's authority and responsibility set forth in Paragraph 9.09. Particularly, but without limitation, during or as a result of Engineer's visits or observations of Contractor's Work Engineer will not supervise, direct, control, or have authority over or be responsible for Contractor's means, methods, techniques, sequences, or procedures of construction, or the safety precautions and programs incident thereto, or for any failure of Contractor to comply with Laws and Regulations applicable to the performance of the Work.

9.03 *Project Representative*

A. If Owner and Engineer agree, Engineer will furnish a Resident Project Representative to assist Engineer in providing more extensive observation of the Work. The authority and responsibilities of any such Resident Project Representative and assistants will be as provided in the Supplementary Conditions, and limitations on the responsibilities thereof will be as provided in Paragraph 9.09. If Owner designates another representative or agent to represent Owner at the Site who is not

Engineer's consultant, agent or employee, the responsibilities and authority and limitations thereon of such other individual or entity will be as provided in the Supplementary Conditions.

#### 9.04 *Authorized Variations in Work*

A. Engineer may authorize minor variations in the Work from the requirements of the Contract Documents which do not involve an adjustment in the Contract Price or the Contract Times and are compatible with the design concept of the completed Project as a functioning whole as indicated by the Contract Documents. These may be accomplished by a Field Order and will be binding on Owner and also on Contractor, who shall perform the Work involved promptly. If Owner or Contractor believes that a Field Order justifies an adjustment in the Contract Price or Contract Times, or both, and the parties are unable to agree on entitlement to or on the amount or extent, if any, of any such adjustment, a Claim may be made therefor as provided in Paragraph 10.05.

#### 9.05 *Rejecting Defective Work*

A. Engineer will have authority to reject Work which Engineer believes to be defective, or that Engineer believes will not produce a completed Project that conforms to the Contract Documents or that will prejudice the integrity of the design concept of the completed Project as a functioning whole as indicated by the Contract Documents. Engineer will also have authority to require special inspection or testing of the Work as provided in Paragraph 13.04, whether or not the Work is fabricated, installed, or completed.

#### 9.06 *Shop Drawings, Change Orders and Payments*

A. In connection with Engineer's authority, and limitations thereof, as to Shop Drawings and Samples, see Paragraph 6.17.

B. In connection with Engineer's authority, and limitations thereof, as to design calculations and design drawings submitted in response to a delegation of professional design services, if any, see Paragraph 6.21.

C. In connection with Engineer's authority as to Change Orders, see Articles 10, 11, and 12.

D. In connection with Engineer's authority as to Applications for Payment, see Article 14.

#### 9.07 *Determinations for Unit Price Work*

A. Engineer will determine the actual quantities and classifications of Unit Price Work performed by Contractor. Engineer will review with Contractor the Engineer's preliminary determinations on such matters before rendering a written decision thereon (by recommendation of an Application for Payment or otherwise). Engineer's written decision thereon will be

final and binding (except as modified by Engineer to reflect changed factual conditions or more accurate data) upon Owner and Contractor, subject to the provisions of Paragraph 10.05.

#### 9.08 *Decisions on Requirements of Contract Documents and Acceptability of Work*

A. Engineer will be the initial interpreter of the requirements of the Contract Documents and judge of the acceptability of the Work thereunder. All matters in question and other matters between Owner and Contractor arising prior to the date final payment is due relating to the acceptability of the Work, and the interpretation of the requirements of the Contract Documents pertaining to the performance of the Work, will be referred initially to Engineer in writing within 30 days of the event giving rise to the question

B. Engineer will, with reasonable promptness, render a written decision on the issue referred. If Owner or Contractor believe that any such decision entitles them to an adjustment in the Contract Price or Contract Times or both, a Claim may be made under Paragraph 10.05. The date of Engineer's decision shall be the date of the event giving rise to the issues referenced for the purposes of Paragraph 10.05.B.

C. Engineer's written decision on the issue referred will be final and binding on Owner and Contractor, subject to the provisions of Paragraph 10.05.

D. When functioning as interpreter and judge under this Paragraph 9.08, Engineer will not show partiality to Owner or Contractor and will not be liable in connection with any interpretation or decision rendered in good faith in such capacity.

#### 9.09 *Limitations on Engineer's Authority and Responsibilities*

A. Neither Engineer's authority or responsibility under this Article 9 or under any other provision of the Contract Documents nor any decision made by Engineer in good faith either to exercise or not exercise such authority or responsibility or the undertaking, exercise, or performance of any authority or responsibility by Engineer shall create, impose, or give rise to any duty in contract, tort, or otherwise owed by Engineer to Contractor, any Subcontractor, any Supplier, any other individual or entity, or to any surety for or employee or agent of any of them.

B. Engineer will not supervise, direct, control, or have authority over or be responsible for Contractor's means, methods, techniques, sequences, or procedures of construction, or the safety precautions and programs incident thereto, or for any failure of Contractor to comply with Laws and Regulations applicable to the performance of the Work. Engineer will not be responsible for Contractor's failure to perform the Work in accordance with the Contract Documents.

C. Engineer will not be responsible for the acts or omissions of Contractor or of any Subcontractor, any Supplier, or of any other individual or entity performing any of the Work.

D. Engineer's review of the final Application for Payment and accompanying documentation and all maintenance and operating instructions, schedules, guarantees, bonds, certificates of inspection, tests and approvals, and other documentation required to be delivered by Paragraph 14.07.A will only be to determine generally that their content complies with the requirements of, and in the case of certificates of inspections, tests, and approvals that the results certified indicate compliance with the Contract Documents.

E. The limitations upon authority and responsibility set forth in this Paragraph 9.09 shall also apply to, the Resident Project Representative, if any, and assistants, if any.

## ARTICLE 10 - CHANGES IN THE WORK; CLAIMS

---

### 10.01 *Authorized Changes in the Work*

A. Without invalidating the Contract and without notice to any surety, Owner may, at any time or from time to time, order additions, deletions, or revisions in the Work by a Change Order, or a Work Change Directive. Upon receipt of any such document, Contractor shall promptly proceed with the Work involved which will be performed under the applicable conditions of the Contract Documents (except as otherwise specifically provided).

B. If Owner and Contractor are unable to agree on entitlement to, or on the amount or extent, if any, of an adjustment in the Contract Price or Contract Times, or both, that should be allowed as a result of a Work Change Directive, a Claim may be made therefor as provided in Paragraph 10.05.

### 10.02 *Unauthorized Changes in the Work*

A. Contractor shall not be entitled to an increase in the Contract Price or an extension of the Contract Times with respect to any work performed that is not required by the Contract Documents as amended, modified, or supplemented as provided in Paragraph 3.04, except in the case of an emergency as provided in Paragraph 6.16 or in the case of uncovering Work as provided in Paragraph 13.04.B.

### 10.03 *Execution of Change Orders*

A. Owner and Contractor shall execute appropriate Change Orders recommended by Engineer covering:

1. changes in the Work which are: (i) ordered by Owner pursuant to Paragraph 10.01.A, (ii) required because of acceptance of defective Work under Paragraph 13.08.A or Owner's correction of defective Work under Paragraph 13.09, or (iii) agreed to by the parties;

2. changes in the Contract Price or Contract Times which are agreed to by the parties, including any undisputed sum or amount of time for Work actually performed in accordance with a Work Change Directive; and

3. changes in the Contract Price or Contract Times which embody the substance of any written decision rendered by Engineer pursuant to Paragraph 10.05; provided that, in lieu of executing any such Change Order, an appeal may be taken from any such decision in accordance with the provisions of the Contract Documents and applicable Laws and Regulations, but during any such appeal, Contractor shall carry on the Work and adhere to the Progress Schedule as provided in Paragraph 6.18.A.

### 10.04 *Notification to Surety*

A. If notice of any change affecting the general scope of the Work or the provisions of the Contract Documents (including, but not limited to, Contract Price or Contract Times) is required by the provisions of any bond to be given to a surety, the giving of any such notice will be Contractor's responsibility. The amount of each applicable bond will be adjusted to reflect the effect of any such change.

### 10.05 *Claims*

A. *Engineer's Decision Required:* All Claims, except those waived pursuant to Paragraph 14.09, shall be referred to the Engineer for decision. A decision by Engineer shall be required as a condition precedent to any exercise by Owner or Contractor of any rights or remedies either may otherwise have under the Contract Documents or by Laws and Regulations in respect of such Claims.

B. *Notice:* Written notice stating the general nature of each Claim, shall be delivered by the claimant to Engineer and the other party to the Contract promptly (but in no event later than 30 days) after the start of the event giving rise thereto. The responsibility to substantiate a Claim shall rest with the party making the Claim. Notice of the amount or extent of the Claim, with supporting data shall be delivered to the Engineer and the other party to the Contract within 60 days after the start of such event (unless Engineer allows additional time for claimant to submit additional or more accurate data in support of such Claim). A Claim for an adjustment in Contract Price shall be prepared in accordance with the provisions of Paragraph 12.01.B. A Claim for an adjustment in Contract Time shall be prepared in accordance with the provisions of Paragraph

12.02.B. Each Claim shall be accompanied by claimant's written statement that the adjustment claimed is the entire adjustment to which the claimant believes it is entitled as a result of said event. The opposing party shall submit any response to Engineer and the claimant within 30 days after receipt of the claimant's last submittal (unless Engineer allows additional time).

C. *Engineer's Action:* Engineer will review each Claim and, within 30 days after receipt of the last submittal of the claimant or the last submittal of the opposing party, if any, take one of the following actions in writing:

1. deny the Claim in whole or in part,
2. approve the Claim, or

3. notify the parties that the Engineer is unable to resolve the Claim if, in the Engineer's sole discretion, it would be inappropriate for the Engineer to do so. For purposes of further resolution of the Claim, such notice shall be deemed a denial.

D. In the event that Engineer does not take action on a Claim within said 30 days, the Claim shall be deemed denied.

E. Engineer's written action under Paragraph 10.05.C or denial pursuant to Paragraphs 10.05.C.3 or 10.05.D will be final and binding upon Owner and Contractor, unless Owner or Contractor invoke the dispute resolution procedure set forth in Article 16 within 30 days of such action or denial.

F. No Claim for an adjustment in Contract Price or Contract Times will be valid if not submitted in accordance with this Paragraph 10.05.

## ARTICLE 11 - COST OF THE WORK; ALLOWANCES; UNIT PRICE WORK

---

### 11.01 *Cost of the Work*

A. *Costs Included:* The term Cost of the Work means the sum of all costs, except those excluded in Paragraph 11.01.B, necessarily incurred and paid by Contractor in the proper performance of the Work. When the value of any Work covered by a Change Order or when a Claim for an adjustment in Contract Price is determined on the basis of Cost of the Work, the costs to be reimbursed to Contractor will be only those additional or incremental costs required because of the change in the Work or because of the event giving rise to the Claim. Except as otherwise may be agreed to in writing by Owner, such costs shall be in amounts no higher than those prevailing in the locality of the Project, shall include only the following items, and shall not include any of the costs itemized in Paragraph 11.01.B.

1. Payroll costs for employees in the direct employ of Contractor in the performance of the Work under schedules of job classifications agreed upon by Owner and Contractor. Such employees shall include, without limitation, superintendents, foremen, and other personnel employed full time at the Site. Payroll costs for employees not employed full time on the Work shall be apportioned on the basis of their time spent on the Work. Payroll costs shall include, but not be limited to, salaries and wages plus the cost of fringe benefits, which shall include social security contributions, unemployment, excise, and payroll taxes, workers' compensation, health and retirement benefits, bonuses, sick leave, vacation and holiday pay applicable thereto. The expenses of performing Work outside of regular working hours, on Saturday, Sunday, or legal holidays, shall be included in the above to the extent authorized by Owner.

2. Cost of all materials and equipment furnished and incorporated in the Work, including costs of transportation and storage thereof, and Suppliers' field services required in connection therewith. All cash discounts shall accrue to Contractor unless Owner deposits funds with Contractor with which to make payments, in which case the cash discounts shall accrue to Owner. All trade discounts, rebates and refunds and returns from sale of surplus materials and equipment shall accrue to Owner, and Contractor shall make provisions so that they may be obtained.

3. Payments made by Contractor to Subcontractors for Work performed by Subcontractors. If required by Owner, Contractor shall obtain competitive bids from subcontractors acceptable to Owner and Contractor and shall deliver such bids to Owner, who will then determine, with the advice of Engineer, which bids, if any, will be acceptable. If any subcontract provides that the Subcontractor is to be paid on the basis of Cost of the Work plus a fee, the Subcontractor's Cost of the Work and fee shall be determined in the same manner as Contractor's Cost of the Work and fee as provided in this Paragraph 11.01.

4. Costs of special consultants (including but not limited to Engineers, architects, testing laboratories, surveyors, attorneys, and accountants) employed for services specifically related to the Work.

5. Supplemental costs including the following:

a. The proportion of necessary transportation, travel, and subsistence expenses of Contractor's employees incurred in discharge of duties connected with the Work.

b. Cost, including transportation and maintenance, of all materials, supplies, equipment,

machinery, appliances, office, and temporary facilities at the Site, and hand tools not owned by the workers, which are consumed in the performance of the Work, and cost, less market value, of such items used but not consumed which remain the property of Contractor.

c. Rentals of all construction equipment and machinery, and the parts thereof whether rented from Contractor or others in accordance with rental agreements approved by Owner with the advice of Engineer, and the costs of transportation, loading, unloading, assembly, dismantling, and removal thereof. All such costs shall be in accordance with the terms of said rental agreements. The rental of any such equipment, machinery, or parts shall cease when the use thereof is no longer necessary for the Work.

d. Sales, consumer, use, and other similar taxes related to the Work, and for which Contractor is liable, imposed by Laws and Regulations.

e. Deposits lost for causes other than negligence of Contractor, any Subcontractor, or anyone directly or indirectly employed by any of them or for whose acts any of them may be liable, and royalty payments and fees for permits and licenses.

f. Losses and damages (and related expenses) caused by damage to the Work, not compensated by insurance or otherwise, sustained by Contractor in connection with the performance of the Work (except losses and damages within the deductible amounts of property insurance established in accordance with Paragraph 5.06.D), provided such losses and damages have resulted from causes other than the negligence of Contractor, any Subcontractor, or anyone directly or indirectly employed by any of them or for whose acts any of them may be liable. Such losses shall include settlements made with the written consent and approval of Owner. No such losses, damages, and expenses shall be included in the Cost of the Work for the purpose of determining Contractor's fee.

g. The cost of utilities, fuel, and sanitary facilities at the Site.

h. Minor expenses such as telegrams, long distance telephone calls, telephone service at the Site, expresses, and similar petty cash items in connection with the Work.

i. The costs of premiums for all bonds and insurance Contractor is required by the Contract Documents to purchase and maintain.

**B. *Costs Excluded:*** The term Cost of the Work shall not include any of the following items:

1. Payroll costs and other compensation of Contractor's officers, executives, principals (of partnerships and sole proprietorships), general managers, safety managers, engineers, architects, estimators, attorneys, auditors, accountants, purchasing and contracting agents, expeditors, timekeepers, clerks, and other personnel employed by Contractor, whether at the Site or in Contractor's principal or branch office for general administration of the Work and not specifically included in the agreed upon schedule of job classifications referred to in Paragraph 11.01.A.1 or specifically covered by Paragraph 11.01.A.4, all of which are to be considered administrative costs covered by the Contractor's fee.

2. Expenses of Contractor's principal and branch offices other than Contractor's office at the Site.

3. Any part of Contractor's capital expenses, including interest on Contractor's capital employed for the Work and charges against Contractor for delinquent payments.

4. Costs due to the negligence of Contractor, any Subcontractor, or anyone directly or indirectly employed by any of them or for whose acts any of them may be liable, including but not limited to, the correction of defective Work, disposal of materials or equipment wrongly supplied, and making good any damage to property.

5. Other overhead or general expense costs of any kind and the costs of any item not specifically and expressly included in Paragraphs 11.01.A and 11.01.B.

**C. *Contractor's Fee:*** When all the Work is performed on the basis of cost-plus, Contractor's fee shall be determined as set forth in the Agreement. When the value of any Work covered by a Change Order or when a Claim for an adjustment in Contract Price is determined on the basis of Cost of the Work, Contractor's fee shall be determined as set forth in Paragraph 12.01.C.

**D. *Documentation:*** Whenever the Cost of the Work for any purpose is to be determined pursuant to Paragraphs 11.01.A and 11.01.B, Contractor will establish and maintain records thereof in accordance with generally accepted accounting practices and submit in a form acceptable to Engineer an itemized cost breakdown together with supporting data.

## 11.02 Allowances

A. It is understood that Contractor has included in the Contract Price all allowances so named in the Contract Documents and shall cause the Work so covered to be performed for such sums and by such persons or entities as may be acceptable to Owner and Engineer.

*B. Cash Allowances*

1. Contractor agrees that:

a. the cash allowances include the cost to Contractor (less any applicable trade discounts) of materials and equipment required by the allowances to be delivered at the Site, and all applicable taxes; and

b. Contractor's costs for unloading and handling on the Site, labor, installation, overhead, profit, and other expenses contemplated for the cash allowances have been included in the Contract Price and not in the allowances, and no demand for additional payment on account of any of the foregoing will be valid.

*C. Contingency Allowance*

1. Contractor agrees that a contingency allowance, if any, is for the sole use of Owner to cover unanticipated costs.

D. Prior to final payment, an appropriate Change Order will be issued as recommended by Engineer to reflect actual amounts due Contractor on account of Work covered by allowances, and the Contract Price shall be correspondingly adjusted.

*11.03 Unit Price Work*

A. Where the Contract Documents provide that all or part of the Work is to be Unit Price Work, initially the Contract Price will be deemed to include for all Unit Price Work an amount equal to the sum of the unit price for each separately identified item of Unit Price Work times the estimated quantity of each item as indicated in the Agreement.

B. The estimated quantities of items of Unit Price Work are not guaranteed and are solely for the purpose of comparison of Bids and determining an initial Contract Price. Determinations of the actual quantities and classifications of Unit Price Work performed by Contractor will be made by Engineer subject to the provisions of Paragraph 9.07.

C. Each unit price will be deemed to include an amount considered by Contractor to be adequate to cover Contractor's overhead and profit for each separately identified item.

D. Owner or Contractor may make a Claim for an adjustment in the Contract Price in accordance with Paragraph 10.05 if:

1. the quantity of any item of Unit Price Work performed by Contractor differs materially and significantly from the estimated quantity of such item indicated in the Agreement; and

2. there is no corresponding adjustment with respect any other item of Work; and

3. Contractor believes that Contractor is entitled to an increase in Contract Price as a result of having incurred additional expense or Owner believes that Owner is entitled to a decrease in Contract Price and the parties are unable to agree as to the amount of any such increase or decrease.

**ARTICLE 12 - CHANGE OF CONTRACT PRICE;  
CHANGE OF CONTRACT TIMES**

---

*12.01 Change of Contract Price*

A. The Contract Price may only be changed by a Change Order. Any Claim for an adjustment in the Contract Price shall be based on written notice submitted by the party making the Claim to the Engineer and the other party to the Contract in accordance with the provisions of Paragraph 10.05.

B. The value of any Work covered by a Change Order or of any Claim for an adjustment in the Contract Price will be determined as follows:

1. where the Work involved is covered by unit prices contained in the Contract Documents, by application of such unit prices to the quantities of the items involved (subject to the provisions of Paragraph 11.03); or

2. where the Work involved is not covered by unit prices contained in the Contract Documents, by a mutually agreed lump sum (which may include an allowance for overhead and profit not necessarily in accordance with Paragraph 12.01.C.2); or

3. where the Work involved is not covered by unit prices contained in the Contract Documents and agreement to a lump sum is not reached under Paragraph 12.01.B.2, on the basis of the Cost of the Work (determined as provided in Paragraph 11.01) plus a Contractor's fee for overhead and profit (determined as provided in Paragraph 12.01.C).

C. *Contractor's Fee:* The Contractor's fee for overhead and profit shall be determined as follows:



1. a mutually acceptable fixed fee; or

2. if a fixed fee is not agreed upon, then a fee based on the following percentages of the various portions of the Cost of the Work:

a. for costs incurred under Paragraphs 11.01.A.1 and 11.01.A.2, the Contractor's fee shall be 15 percent;

b. for costs incurred under Paragraph 11.01.A.3, the Contractor's fee shall be five percent;

c. where one or more tiers of subcontracts are on the basis of Cost of the Work plus a fee and no fixed fee is agreed upon, the intent of Paragraph 12.01.C.2.a is that the Subcontractor who actually performs the Work, at whatever tier, will be paid a fee of 15 percent of the costs incurred by such Subcontractor under Paragraphs 11.01.A.1 and 11.01.A.2 and that any higher tier Subcontractor and Contractor will each be paid a fee of five percent of the amount paid to the next lower tier Subcontractor;

d. no fee shall be payable on the basis of costs itemized under Paragraphs 11.01.A.4, 11.01.A.5, and 11.01.B;

e. the amount of credit to be allowed by Contractor to Owner for any change which results in a net decrease in cost will be the amount of the actual net decrease in cost plus a deduction in Contractor's fee by an amount equal to five percent of such net decrease; and

f. when both additions and credits are involved in any one change, the adjustment in Contractor's fee shall be computed on the basis of the net change in accordance with Paragraphs 12.01.C.2.a through 12.01.C.2.e, inclusive.

## 12.02 *Change of Contract Times*

A. The Contract Times may only be changed by a Change Order. Any Claim for an adjustment in the Contract Times shall be based on written notice submitted by the party making the Claim to the Engineer and the other party to the Contract in accordance with the provisions of Paragraph 10.05.

B. Any adjustment of the Contract Times covered by a Change Order or any Claim for an adjustment in the Contract Times will be determined in accordance with the provisions of this Article 12.

## 12.03 *Delays*

A. Where Contractor is prevented from completing any part of the Work within the Contract Times due to delay beyond the control of Contractor, the Contract Times will be extended in an amount equal to the time lost due to such delay if a Claim is made therefor as provided in Paragraph 12.02.A. Delays beyond the control of Contractor shall include, but not be limited to, acts or neglect by Owner, acts or neglect of utility owners or other contractors performing other work as contemplated by Article 7, fires, floods, epidemics, abnormal weather conditions, or acts of God.

B. If Owner, Engineer, or other contractors or utility owners performing other work for Owner as contemplated by Article 7, or anyone for whom Owner is responsible, delays, disrupts, or interferes with the performance or progress of the Work, then Contractor shall be entitled to an equitable adjustment in the Contract Price or the Contract Times, or both. Contractor's entitlement to an adjustment of the Contract Times is conditioned on such adjustment being essential to Contractor's ability to complete the Work within the Contract Times.

C. If Contractor is delayed in the performance or progress of the Work by fire, flood, epidemic, abnormal weather conditions, acts of God, acts or failures to act of utility owners not under the control of Owner, or other causes not the fault of and beyond control of Owner and Contractor, then Contractor shall be entitled to an equitable adjustment in Contract Times, if such adjustment is essential to Contractor's ability to complete the Work within the Contract Times. Such an adjustment shall be Contractor's sole and exclusive remedy for the delays described in this Paragraph 12.03.C.

D. Owner, Engineer and the Related Entities of each of them shall not be liable to Contractor for any claims, costs, losses, or damages (including but not limited to all fees and charges of Engineers, architects, attorneys, and other professionals and all court or arbitration or other dispute resolution costs) sustained by Contractor on or in connection with any other project or anticipated project.

E. Contractor shall not be entitled to an adjustment in Contract Price or Contract Times for delays within the control of Contractor. Delays attributable to and within the control of a Subcontractor or Supplier shall be deemed to be delays within the control of Contractor.

## ARTICLE 13 - TESTS AND INSPECTIONS; CORRECTION, REMOVAL OR ACCEPTANCE OF DEFECTIVE WORK

### 13.01 *Notice of Defects*

A. Prompt notice of all defective Work of which Owner or Engineer has actual knowledge will be given to

Contractor. All defective Work may be rejected, corrected, or accepted as provided in this Article 13.

### 13.02 *Access to Work*

A. Owner, Engineer, their consultants and other representatives and personnel of Owner, independent testing laboratories, and governmental agencies with jurisdictional interests will have access to the Site and the Work at reasonable times for their observation, inspecting, and testing. Contractor shall provide them proper and safe conditions for such access and advise them of Contractor's Site safety procedures and programs so that they may comply therewith as applicable.

### 13.03 *Tests and Inspections*

A. Contractor shall give Engineer timely notice of readiness of the Work for all required inspections, tests, or approvals and shall cooperate with inspection and testing personnel to facilitate required inspections or tests.

B. Owner shall employ and pay for the services of an independent testing laboratory to perform all inspections, tests, or approvals required by the Contract Documents except:

1. for inspections, tests, or approvals covered by Paragraphs 13.03.C and 13.03.D below;
2. that costs incurred in connection with tests or inspections conducted pursuant to Paragraph 13.04.B shall be paid as provided in said Paragraph 13.04.C; and
3. as otherwise specifically provided in the Contract Documents.

C. If Laws or Regulations of any public body having jurisdiction require any Work (or part thereof) specifically to be inspected, tested, or approved by an employee or other representative of such public body, Contractor shall assume full responsibility for arranging and obtaining such inspections, tests, or approvals, pay all costs in connection therewith, and furnish Engineer the required certificates of inspection or approval.

D. Contractor shall be responsible for arranging and obtaining and shall pay all costs in connection with any inspections, tests, or approvals required for Owner's and Engineer's acceptance of materials or equipment to be incorporated in the Work; or acceptance of materials, mix designs, or equipment submitted for approval prior to Contractor's purchase thereof for incorporation in the Work. Such inspections, tests, or approvals shall be performed by organizations acceptable to Owner and Engineer.

E. If any Work (or the work of others) that is to be inspected, tested, or approved is covered by Contractor

without written concurrence of Engineer, it must, if requested by Engineer, be uncovered for observation.

F. Uncovering Work as provided in Paragraph 13.03.E shall be at Contractor's expense unless Contractor has given Engineer timely notice of Contractor's intention to cover the same and Engineer has not acted with reasonable promptness in response to such notice.

### 13.04 *Uncovering Work*

A. If any Work is covered contrary to the written request of Engineer, it must, if requested by Engineer, be uncovered for Engineer's observation and replaced at Contractor's expense.

B. If Engineer considers it necessary or advisable that covered Work be observed by Engineer or inspected or tested by others, Contractor, at Engineer's request, shall uncover, expose, or otherwise make available for observation, inspection, or testing as Engineer may require, that portion of the Work in question, furnishing all necessary labor, material, and equipment.

C. If it is found that the uncovered Work is defective, Contractor shall pay all claims, costs, losses, and damages (including but not limited to all fees and charges of engineers, architects, attorneys, and other professionals and all court or arbitration or other dispute resolution costs) arising out of or relating to such uncovering, exposure, observation, inspection, and testing, and of satisfactory replacement or reconstruction (including but not limited to all costs of repair or replacement of work of others); and Owner shall be entitled to an appropriate decrease in the Contract Price. If the parties are unable to agree as to the amount thereof, Owner may make a Claim therefor as provided in Paragraph 10.05.

D. If, the uncovered Work is not found to be defective, Contractor shall be allowed an increase in the Contract Price or an extension of the Contract Times, or both, directly attributable to such uncovering, exposure, observation, inspection, testing, replacement, and reconstruction. If the parties are unable to agree as to the amount or extent thereof, Contractor may make a Claim therefor as provided in Paragraph 10.05.

### 13.05 *Owner May Stop the Work*

A. If the Work is defective, or Contractor fails to supply sufficient skilled workers or suitable materials or equipment, or fails to perform the Work in such a way that the completed Work will conform to the Contract Documents, Owner may order Contractor to stop the Work, or any portion thereof, until the cause for such order has been eliminated; however, this right of Owner to stop the Work shall not give rise to any duty on the part of Owner to exercise this right for the benefit of Contractor, any Subcontractor, any Supplier, any other individual or entity, or any surety for, or employee or agent of any of them.

### 13.06 *Correction or Removal of Defective Work*

A. Promptly after receipt of notice, Contractor shall correct all defective Work, whether or not fabricated, installed, or completed, or, if the Work has been rejected by Engineer, remove it from the Project and replace it with Work that is not defective. Contractor shall pay all claims, costs, losses, and damages (including but not limited to all fees and charges of engineers, architects, attorneys, and other professionals and all court or arbitration or other dispute resolution costs) arising out of or relating to such correction or removal (including but not limited to all costs of repair or replacement of work of others).

B. When correcting defective Work under the terms of this Paragraph 13.06 or Paragraph 13.07, Contractor shall take no action that would void or otherwise impair Owner's special warranty and guarantee, if any, on said Work.

### 13.07 *Correction Period*

A. If within one year after the date of Substantial Completion (or such longer period of time as may be prescribed by the terms of any applicable special guarantee required by the Contract Documents) or by any specific provision of the Contract Documents, any Work is found to be defective, or if the repair of any damages to the land or areas made available for Contractor's use by Owner or permitted by Laws and Regulations as contemplated in Paragraph 6.11.A is found to be defective, Contractor shall promptly, without cost to Owner and in accordance with Owner's written instructions:

1. repair such defective land or areas; or
2. correct such defective Work; or
3. if the defective Work has been rejected by Owner, remove it from the Project and replace it with Work that is not defective, and
4. satisfactorily correct or repair or remove and replace any damage to other Work, to the work of others or other land or areas resulting therefrom.

B. If Contractor does not promptly comply with the terms of Owner's written instructions, or in an emergency where delay would cause serious risk of loss or damage, Owner may have the defective Work corrected or repaired or may have the rejected Work removed and replaced. All claims, costs, losses, and damages (including but not limited to all fees and charges of engineers, architects, attorneys, and other professionals and all court or arbitration or other dispute resolution costs) arising out of or relating to such correction or repair or such removal and replacement (including but not limited to all costs of repair or replacement of work of others) will be paid by Contractor.

C. In special circumstances where a particular item of equipment is placed in continuous service before Substantial Completion of all the Work, the correction period for that item may start to run from an earlier date if so provided in the Specifications .

D. Where defective Work (and damage to other Work resulting therefrom) has been corrected or removed and replaced under this Paragraph 13.07, the correction period hereunder with respect to such Work will be extended for an additional period of one year after such correction or removal and replacement has been satisfactorily completed.

E. Contractor's obligations under this Paragraph 13.07 are in addition to any other obligation or warranty. The provisions of this Paragraph 13.07 shall not be construed as a substitute for or a waiver of the provisions of any applicable statute of limitation or repose.

### 13.08 *Acceptance of Defective Work*

A. If, instead of requiring correction or removal and replacement of defective Work, Owner (and, prior to Engineer's recommendation of final payment, Engineer) prefers to accept it, Owner may do so. Contractor shall pay all claims, costs, losses, and damages (including but not limited to all fees and charges of engineers, architects, attorneys, and other professionals and all court or arbitration or other dispute resolution costs) attributable to Owner's evaluation of and determination to accept such defective Work (such costs to be approved by Engineer as to reasonableness) and the diminished value of the Work to the extent not otherwise paid by Contractor pursuant to this sentence. If any such acceptance occurs prior to Engineer's recommendation of final payment, a Change Order will be issued incorporating the necessary revisions in the Contract Documents with respect to the Work, and Owner shall be entitled to an appropriate decrease in the Contract Price, reflecting the diminished value of Work so accepted. If the parties are unable to agree as to the amount thereof, Owner may make a Claim therefor as provided in Paragraph 10.05. If the acceptance occurs after such recommendation, an appropriate amount will be paid by Contractor to Owner.

### 13.09 *Owner May Correct Defective Work*

A. If Contractor fails within a reasonable time after written notice from Engineer to correct defective Work or to remove and replace rejected Work as required by Engineer in accordance with Paragraph 13.06.A, or if Contractor fails to perform the Work in accordance with the Contract Documents, or if Contractor fails to comply with any other provision of the Contract Documents, Owner may, after seven days written notice to Contractor, correct or remedy any such deficiency.

B. In exercising the rights and remedies under this Paragraph 13.09, Owner shall proceed expeditiously. In connection with such corrective or remedial action, Owner may exclude Contractor from all or part of the Site, take

possession of all or part of the Work and suspend Contractor's services related thereto, take possession of Contractor's tools, appliances, construction equipment and machinery at the Site, and incorporate in the Work all materials and equipment stored at the Site or for which Owner has paid Contractor but which are stored elsewhere. Contractor shall allow Owner, Owner's representatives, agents and employees, Owner's other contractors, and Engineer and Engineer's consultants access to the Site to enable Owner to exercise the rights and remedies under this Paragraph.

C. All claims, costs, losses, and damages (including but not limited to all fees and charges of engineers, architects, attorneys, and other professionals and all court or arbitration or other dispute resolution costs) incurred or sustained by Owner in exercising the rights and remedies under this Paragraph 13.09 will be charged against Contractor, and a Change Order will be issued incorporating the necessary revisions in the Contract Documents with respect to the Work; and Owner shall be entitled to an appropriate decrease in the Contract Price. If the parties are unable to agree as to the amount of the adjustment, Owner may make a Claim therefor as provided in Paragraph 10.05. Such claims, costs, losses and damages will include but not be limited to all costs of repair, or replacement of work of others destroyed or damaged by correction, removal, or replacement of Contractor's defective Work.

D. Contractor shall not be allowed an extension of the Contract Times because of any delay in the performance of the Work attributable to the exercise by Owner of Owner's rights and remedies under this Paragraph 13.09.

## ARTICLE 14 - PAYMENTS TO CONTRACTOR AND COMPLETION

---

### 14.01 *Schedule of Values*

A. The Schedule of Values established as provided in Paragraph 2.07.A will serve as the basis for progress payments and will be incorporated into a form of Application for Payment acceptable to Engineer. Progress payments on account of Unit Price Work will be based on the number of units completed.

### 14.02 *Progress Payments*

#### A. Applications for Payments

1. At least 20 days before the date established in the Agreement for each progress payment (but not more often than once a month), Contractor shall submit to Engineer for review an Application for Payment filled out and signed by Contractor covering the Work completed as of the date of the Application and accompanied by such

supporting documentation as is required by the Contract Documents. If payment is requested on the basis of materials and equipment not incorporated in the Work but delivered and suitably stored at the Site or at another location agreed to in writing, the Application for Payment shall also be accompanied by a bill of sale, invoice, or other documentation warranting that Owner has received the materials and equipment free and clear of all Liens and evidence that the materials and equipment are covered by appropriate property insurance or other arrangements to protect Owner's interest therein, all of which must be satisfactory to Owner.

2. Beginning with the second Application for Payment, each Application shall include an affidavit of Contractor stating that all previous progress payments received on account of the Work have been applied on account to discharge Contractor's legitimate obligations associated with prior Applications for Payment.

3. The amount of retainage with respect to progress payments will be as stipulated in the Agreement.

#### B. *Review of Applications*

1. Engineer will, within 10 days after receipt of each Application for Payment, either indicate in writing a recommendation of payment and present the Application to Owner or return the Application to Contractor indicating in writing Engineer's reasons for refusing to recommend payment. In the latter case, Contractor may make the necessary corrections and resubmit the Application.

2. Engineer's recommendation of any payment requested in an Application for Payment will constitute a representation by Engineer to Owner, based on Engineer's observations on the Site of the executed Work as an experienced and qualified design professional and on Engineer's review of the Application for Payment and the accompanying data and schedules, that to the best of Engineer's knowledge, information and belief:

a. the Work has progressed to the point indicated;

b. the quality of the Work is generally in accordance with the Contract Documents (subject to an evaluation of the Work as a functioning whole prior to or upon Substantial Completion, to the results of any subsequent tests called for in the Contract Documents, to a final determination of quantities and classifications for Unit Price Work under Paragraph 9.07, and to any other qualifications stated in the recommendation); and

c. the conditions precedent to Contractor's being entitled to such payment appear to have been fulfilled in so far as it is Engineer's responsibility to observe the Work.

3. By recommending any such payment Engineer will not thereby be deemed to have represented that:

a. inspections made to check the quality or the quantity of the Work as it has been performed have been exhaustive, extended to every aspect of the Work in progress, or involved detailed inspections of the Work beyond the responsibilities specifically assigned to Engineer in the Contract Documents; or

b. that there may not be other matters or issues between the parties that might entitle Contractor to be paid additionally by Owner or entitle Owner to withhold payment to Contractor.

4. Neither Engineer's review of Contractor's Work for the purposes of recommending payments nor Engineer's recommendation of any payment, including final payment, will impose responsibility on Engineer:

a. to supervise, direct, or control the Work, or

b. for the means, methods, techniques, sequences, or procedures of construction, or the safety precautions and programs incident thereto, or

c. for Contractor's failure to comply with Laws and Regulations applicable to Contractor's performance of the Work, or

d. to make any examination to ascertain how or for what purposes Contractor has used the moneys paid on account of the Contract Price, or

e. to determine that title to any of the Work, materials, or equipment has passed to Owner free and clear of any Liens.

5. Engineer may refuse to recommend the whole or any part of any payment if, in Engineer's opinion, it would be incorrect to make the representations to Owner stated in Paragraph 14.02.B.2. Engineer may also refuse to recommend any such payment or, because of subsequently discovered evidence or the results of subsequent inspections or tests, revise or revoke any such payment recommendation previously made, to such extent as may be necessary in Engineer's opinion to protect Owner from loss because:

a. the Work is defective, or completed Work has been damaged, requiring correction or replacement;

b. the Contract Price has been reduced by Change Orders;

c. Owner has been required to correct defective Work or complete Work in accordance with Paragraph 13.09; or

d. Engineer has actual knowledge of the occurrence of any of the events enumerated in Paragraph 15.02.A.

#### *C. Payment Becomes Due*

1. Ten days after presentation of the Application for Payment to Owner with Engineer's recommendation, the amount recommended will (subject to the provisions of Paragraph 14.02.D) become due, and when due will be paid by Owner to Contractor.

#### *D. Reduction in Payment*

1. Owner may refuse to make payment of the full amount recommended by Engineer because:

a. claims have been made against Owner on account of Contractor's performance or furnishing of the Work;

b. Liens have been filed in connection with the Work, except where Contractor has delivered a specific bond satisfactory to Owner to secure the satisfaction and discharge of such Liens;

c. there are other items entitling Owner to a set-off against the amount recommended; or

d. Owner has actual knowledge of the occurrence of any of the events enumerated in Paragraphs 14.02.B.5.a through 14.02.B.5.c or Paragraph 15.02.A.

2. If Owner refuses to make payment of the full amount recommended by Engineer, Owner will give Contractor immediate written notice (with a copy to Engineer) stating the reasons for such action and promptly pay Contractor any amount remaining after deduction of the amount so withheld. Owner shall promptly pay Contractor the amount so withheld, or any adjustment thereto agreed to by Owner and Contractor, when Contractor corrects to Owner's satisfaction the reasons for such action.

3. If it is subsequently determined that Owner's refusal of payment was not justified, the amount

wrongfully withheld shall be treated as an amount due as determined by Paragraph 14.02.C.1.

#### 14.03 *Contractor's Warranty of Title*

A. Contractor warrants and guarantees that title to all Work, materials, and equipment covered by any Application for Payment, whether incorporated in the Project or not, will pass to Owner no later than the time of payment free and clear of all Liens.

#### 14.04 *Substantial Completion*

A. When Contractor considers the entire Work ready for its intended use Contractor shall notify Owner and Engineer in writing that the entire Work is substantially complete (except for items specifically listed by Contractor as incomplete) and request that Engineer issue a certificate of Substantial Completion.

B. Promptly after Contractor's notification, Owner, Contractor, and Engineer shall make an inspection of the Work to determine the status of completion. If Engineer does not consider the Work substantially complete, Engineer will notify Contractor in writing giving the reasons therefor.

C. If Engineer considers the Work substantially complete, Engineer will deliver to Owner a tentative certificate of Substantial Completion which shall fix the date of Substantial Completion. There shall be attached to the certificate a tentative list of items to be completed or corrected before final payment. Owner shall have seven days after receipt of the tentative certificate during which to make written objection to Engineer as to any provisions of the certificate or attached list. If, after considering such objections, Engineer concludes that the Work is not substantially complete, Engineer will within 14 days after submission of the tentative certificate to Owner notify Contractor in writing, stating the reasons therefor. If, after consideration of Owner's objections, Engineer considers the Work substantially complete, Engineer will within said 14 days execute and deliver to Owner and Contractor a definitive certificate of Substantial Completion (with a revised tentative list of items to be completed or corrected) reflecting such changes from the tentative certificate as Engineer believes justified after consideration of any objections from Owner.

D. At the time of delivery of the tentative certificate of Substantial Completion, Engineer will deliver to Owner and Contractor a written recommendation as to division of responsibilities pending final payment between Owner and Contractor with respect to security, operation, safety, and protection of the Work, maintenance, heat, utilities, insurance, and warranties and guarantees. Unless Owner and Contractor agree otherwise in writing and so inform Engineer in writing prior to Engineer's issuing the definitive certificate of Substantial Completion, Engineer's aforesaid recommendation will be binding on Owner and Contractor until final payment.

E. Owner shall have the right to exclude Contractor from the Site after the date of Substantial Completion subject to allowing Contractor reasonable access to complete or correct items on the tentative list.

#### 14.05 *Partial Utilization*

A. Prior to Substantial Completion of all the Work, Owner may use or occupy any substantially completed part of the Work which has specifically been identified in the Contract Documents, or which Owner, Engineer, and Contractor agree constitutes a separately functioning and usable part of the Work that can be used by Owner for its intended purpose without significant interference with Contractor's performance of the remainder of the Work, subject to the following conditions.

1. Owner at any time may request Contractor in writing to permit Owner to use or occupy any such part of the Work which Owner believes to be ready for its intended use and substantially complete. If and when Contractor agrees that such part of the Work is substantially complete, Contractor will certify to Owner and Engineer that such part of the Work is substantially complete and request Engineer to issue a certificate of Substantial Completion for that part of the Work.

2. Contractor at any time may notify Owner and Engineer in writing that Contractor considers any such part of the Work ready for its intended use and substantially complete and request Engineer to issue a certificate of Substantial Completion for that part of the Work.

3. Within a reasonable time after either such request, Owner, Contractor, and Engineer shall make an inspection of that part of the Work to determine its status of completion. If Engineer does not consider that part of the Work to be substantially complete, Engineer will notify Owner and Contractor in writing giving the reasons therefor. If Engineer considers that part of the Work to be substantially complete, the provisions of Paragraph 14.04 will apply with respect to certification of Substantial Completion of that part of the Work and the division of responsibility in respect thereof and access thereto.

4. No use or occupancy or separate operation of part of the Work may occur prior to compliance with the requirements of Paragraph 5.10 regarding property insurance.

#### 14.06 *Final Inspection*

A. Upon written notice from Contractor that the entire Work or an agreed portion thereof is complete, Engineer will promptly make a final inspection with Owner and Contractor and will notify Contractor in writing of all particulars in which this inspection reveals that the Work is incomplete or defective. Contractor shall immediately

take such measures as are necessary to complete such Work or remedy such deficiencies.

#### 14.07 *Final Payment*

##### A. Application for Payment

1. After Contractor has, in the opinion of Engineer, satisfactorily completed all corrections identified during the final inspection and has delivered, in accordance with the Contract Documents, all maintenance and operating instructions, schedules, guarantees, bonds, certificates or other evidence of insurance certificates of inspection, marked-up record documents (as provided in Paragraph 6.12), and other documents, Contractor may make application for final payment following the procedure for progress payments.

2. The final Application for Payment shall be accompanied (except as previously delivered) by:

- a. all documentation called for in the Contract Documents, including but not limited to the evidence of insurance required by Paragraph 5.04.B.7;
- b. consent of the surety, if any, to final payment;
- c. a list of all Claims against Owner that Contractor believes are unsettled; and
- d. complete and legally effective releases or waivers (satisfactory to Owner) of all Lien rights arising out of or Liens filed in connection with the Work.

3. In lieu of the releases or waivers of Liens specified in Paragraph 14.07.A.2 and as approved by Owner, Contractor may furnish receipts or releases in full and an affidavit of Contractor that: (i) the releases and receipts include all labor, services, material, and equipment for which a Lien could be filed; and (ii) all payrolls, material and equipment bills, and other indebtedness connected with the Work for which Owner or Owner's property might in any way be responsible have been paid or otherwise satisfied. If any Subcontractor or Supplier fails to furnish such a release or receipt in full, Contractor may furnish a bond or other collateral satisfactory to Owner to indemnify Owner against any Lien.

##### B. *Engineer's Review of Application and Acceptance*

1. If, on the basis of Engineer's observation of the Work during construction and final inspection, and Engineer's review of the final Application for Payment and accompanying documentation as required by the Contract

Documents, Engineer is satisfied that the Work has been completed and Contractor's other obligations under the Contract Documents have been fulfilled, Engineer will, within ten days after receipt of the final Application for Payment, indicate in writing Engineer's recommendation of payment and present the Application for Payment to Owner for payment. At the same time Engineer will also give written notice to Owner and Contractor that the Work is acceptable subject to the provisions of Paragraph 14.09. Otherwise, Engineer will return the Application for Payment to Contractor, indicating in writing the reasons for refusing to recommend final payment, in which case Contractor shall make the necessary corrections and resubmit the Application for Payment.

##### C. Payment Becomes Due

1. Thirty days after the presentation to Owner of the Application for Payment and accompanying documentation, the amount recommended by Engineer, less any sum Owner is entitled to set off against Engineer's recommendation, including but not limited to liquidated damages, will become due and , will be paid by Owner to Contractor.

#### 14.08 *Final Completion Delayed*

A. If, through no fault of Contractor, final completion of the Work is significantly delayed, and if Engineer so confirms, Owner shall, upon receipt of Contractor's final Application for Payment (for Work fully completed and accepted) and recommendation of Engineer, and without terminating the Contract, make payment of the balance due for that portion of the Work fully completed and accepted. If the remaining balance to be held by Owner for Work not fully completed or corrected is less than the retainage stipulated in the Agreement, and if bonds have been furnished as required in Paragraph 5.01, the written consent of the surety to the payment of the balance due for that portion of the Work fully completed and accepted shall be submitted by Contractor to Engineer with the Application for such payment. Such payment shall be made under the terms and conditions governing final payment, except that it shall not constitute a waiver of Claims.

#### 14.09 *Waiver of Claims*

A. The making and acceptance of final payment will constitute:

1. a waiver of all Claims by Owner against Contractor, except Claims arising from unsettled Liens, from defective Work appearing after final inspection pursuant to Paragraph 14.06, from failure to comply with the Contract Documents or the terms of any special guarantees specified therein, or from Contractor's

continuing obligations under the Contract Documents;  
and

2. a waiver of all Claims by Contractor against Owner other than those previously made in accordance with the requirements herein and expressly acknowledged by Owner in writing as still unsettled.

## ARTICLE 15 - SUSPENSION OF WORK AND TERMINATION

---

### 15.01 *Owner May Suspend Work*

A. At any time and without cause, Owner may suspend the Work or any portion thereof for a period of not more than 90 consecutive days by notice in writing to Contractor and Engineer which will fix the date on which Work will be resumed. Contractor shall resume the Work on the date so fixed. Contractor shall be granted an adjustment in the Contract Price or an extension of the Contract Times, or both, directly attributable to any such suspension if Contractor makes a Claim therefor as provided in Paragraph 10.05.

### 15.02 *Owner May Terminate for Cause*

A. The occurrence of any one or more of the following events will justify termination for cause:

1. Contractor's persistent failure to perform the Work in accordance with the Contract Documents (including, but not limited to, failure to supply sufficient skilled workers or suitable materials or equipment or failure to adhere to the Progress Schedule established under Paragraph 2.07 as adjusted from time to time pursuant to Paragraph 6.04);

2. Contractor's disregard of Laws or Regulations of any public body having jurisdiction;

3. Contractor's disregard of the authority of Engineer; or

4. Contractor's violation in any substantial way of any provisions of the Contract Documents.

B. If one or more of the events identified in Paragraph 15.02.A occur, Owner may, after giving Contractor (and surety ) seven days written notice of its intent to terminate the services of Contractor:

1. exclude Contractor from the Site, and take possession of the Work and of all Contractor's tools, appliances, construction equipment, and machinery at the Site, and use the same to the full extent they could be

used by Contractor (without liability to Contractor for trespass or conversion),

2. incorporate in the Work all materials and equipment stored at the Site or for which Owner has paid Contractor but which are stored elsewhere, and

3. complete the Work as Owner may deem expedient.

C. If Owner proceeds as provided in Paragraph 15.02.B, Contractor shall not be entitled to receive any further payment until the Work is completed. If the unpaid balance of the Contract Price exceeds all claims, costs, losses, and damages (including but not limited to all fees and charges of engineers, architects, attorneys, and other professionals and all court or arbitration or other dispute resolution costs) sustained by Owner arising out of or relating to completing the Work, such excess will be paid to Contractor. If such claims, costs, losses, and damages exceed such unpaid balance, Contractor shall pay the difference to Owner. Such claims, costs, losses, and damages incurred by Owner will be reviewed by Engineer as to their reasonableness and, when so approved by Engineer, incorporated in a Change Order. When exercising any rights or remedies under this Paragraph Owner shall not be required to obtain the lowest price for the Work performed.

D. Notwithstanding Paragraphs 15.02.B and 15.02.C, Contractor's services will not be terminated if Contractor begins within seven days of receipt of notice of intent to terminate to correct its failure to perform and proceeds diligently to cure such failure within no more than 30 days of receipt of said notice.

E. Where Contractor's services have been so terminated by Owner, the termination will not affect any rights or remedies of Owner against Contractor then existing or which may thereafter accrue. Any retention or payment of moneys due Contractor by Owner will not release Contractor from liability.

F. If and to the extent that Contractor has provided a performance bond under the provisions of Paragraph 5.01.A, the termination procedures of that bond shall supersede the provisions of Paragraphs 15.02.B, and 15.02.C.

### 15.03 *Owner May Terminate For Convenience*

A. Upon seven days written notice to Contractor and Engineer, Owner may, without cause and without prejudice to any other right or remedy of Owner, terminate the Contract. In such case, Contractor shall be paid for (without duplication of any items):

1. completed and acceptable Work executed in accordance with the Contract Documents prior to the



effective date of termination, including fair and reasonable sums for overhead and profit on such Work;

2. expenses sustained prior to the effective date of termination in performing services and furnishing labor, materials, or equipment as required by the Contract Documents in connection with uncompleted Work, plus fair and reasonable sums for overhead and profit on such expenses;

3. all claims, costs, losses, and damages (including but not limited to all fees and charges of engineers, architects, attorneys, and other professionals and all court or arbitration or other dispute resolution costs) incurred in settlement of terminated contracts with Subcontractors, Suppliers, and others; and

4. reasonable expenses directly attributable to termination.

B. Contractor shall not be paid on account of loss of anticipated profits or revenue or other economic loss arising out of or resulting from such termination.

#### 15.04 *Contractor May Stop Work or Terminate*

A. If, through no act or fault of Contractor, (i) the Work is suspended for more than 90 consecutive days by Owner or under an order of court or other public authority, or (ii) Engineer fails to act on any Application for Payment within 30 days after it is submitted, or (iii) Owner fails for 30 days to pay Contractor any sum finally determined to be due, then Contractor may, upon seven days written notice to Owner and Engineer, and provided Owner or Engineer do not remedy such suspension or failure within that time, terminate the Contract and recover from Owner payment on the same terms as provided in Paragraph 15.03.

B. In lieu of terminating the Contract and without prejudice to any other right or remedy, if Engineer has failed to act on an Application for Payment within 30 days after it is submitted, or Owner has failed for 30 days to pay Contractor any sum finally determined to be due, Contractor may, seven days after written notice to Owner and Engineer, stop the Work until payment is made of all such amounts due Contractor, including interest thereon. The provisions of this Paragraph 15.04 are not intended to preclude Contractor from making a Claim under Paragraph 10.05 for an adjustment in Contract Price or Contract Times or otherwise for expenses or damage directly attributable to Contractor's stopping the Work as permitted by this Paragraph.

## ARTICLE 16 - DISPUTE RESOLUTION

---

### 16.01 *Methods and Procedures*

A. Either Owner or Contractor may request mediation of any Claim submitted to Engineer for a decision under Paragraph 10.05 before such decision becomes final and binding. The mediation will be governed by the Construction Industry Mediation Rules of the American Arbitration Association in effect as of the Effective Date of the Agreement. The request for mediation shall be submitted in writing to the American Arbitration Association and the other party to the Contract. Timely submission of the request shall stay the effect of Paragraph 10.05.E.

B. Owner and Contractor shall participate in the mediation process in good faith. The process shall be concluded within 60 days of filing of the request. The date of termination of the mediation shall be determined by application of the mediation rules referenced above.

C. If the Claim is not resolved by mediation, Engineer's action under Paragraph 10.05.C or a denial pursuant to Paragraphs 10.05.C.3 or 10.05.D shall become final and binding 30 days after termination of the mediation unless, within that time period, Owner or Contractor:

1. elects in writing to invoke any dispute resolution process provided for in the Supplementary Conditions, or
2. agrees with the other party to submit the Claim to another dispute resolution process, or
3. gives written notice to the other party of their intent to submit the Claim to a court of competent jurisdiction.

## ARTICLE 17 - MISCELLANEOUS

---

### 17.01 *Giving Notice*

A. Whenever any provision of the Contract Documents requires the giving of written notice, it will be deemed to have been validly given if:

1. delivered in person to the individual or to a member of the firm or to an officer of the corporation for whom it is intended, or
2. delivered at or sent by registered or certified mail, postage prepaid, to the last business address known to the giver of the notice.

### 17.02 *Computation of Times*

A. When any period of time is referred to in the Contract Documents by days, it will be computed to exclude the first and include the last day of such period. If the last day of any such period falls on a Saturday or Sunday or on a day made a legal holiday by the law of the applicable jurisdiction, such day will be omitted from the computation.

#### 17.03 *Cumulative Remedies*

A. The duties and obligations imposed by these General Conditions and the rights and remedies available hereunder to the parties hereto are in addition to, and are not to be construed in any way as a limitation of, any rights and remedies available to any or all of them which are otherwise imposed or available by Laws or Regulations, by special warranty or guarantee, or by other provisions of the Contract Documents. The provisions of this Paragraph will be as effective as if repeated specifically in the Contract Documents in connection with each particular duty, obligation, right, and remedy to which they apply.

#### 17.04 *Survival of Obligations*

A. All representations, indemnifications, warranties, and guarantees made in, required by, or given in accordance with the Contract Documents, as well as all continuing obligations indicated in the Contract Documents, will survive final payment, completion, and acceptance of the Work or termination or completion of the Contract or termination of the services of Contractor.

#### 17.05 *Controlling Law*

A. This Contract is to be governed by the law of the state in which the Project is located.

#### 17.06 *Headings*

A. Article and paragraph headings are inserted for convenience only and do not constitute parts of these General Conditions.

## TAB E

Supplementary Conditions



## SUPPLEMENTARY CONDITIONS

These Supplementary Conditions amend or supplement the General Conditions and other provisions of the Contract Documents as indicated below. All provisions which are not so amended or supplemented remain in full force and effect.

Article 1 Revisions:

### **1.01.29 Owner**

After the word “performed,” add the words “Owner may designate in writing one or more authorized representatives who shall have express authority to bind the Owner with respect to matters requiring Owner’s approval or authorization. The Engineer does not have such authority. The term “Owner” means the Owner, and the Owner’s Authorized Representative. The Owner’s Authorized Representative is not to be confused with the owner’s representative to which Article 9 refers.”

Article 2 Revisions:

### **2.05 Before Starting Construction**

To Paragraph 2.05.A, after the word “review,” add the words “and Owner’s approval:”

Delete Article 2.05.B.3 and add the following new Article 2.05.D:

Documentation submitted by CONTRACTOR prior to execution of Agreement shall include a preliminary schedule of values for all of the Work that includes quantities and prices of items which, when added together, equal the Contract Price and subdivides the Work into component parts in sufficient detail to serve as the basis for progress payments during performance of the Work. Such prices will include an appropriate amount of overhead and profit applicable to each item of Work. The approved schedule of values shall follow the format provided in the Bidding Documents.

### **2.07 Initial Acceptance of Schedules**

To Paragraph 2.07.A, after the word “Engineer,” in line 4, add the words “and Owner”. And after the word “Engineer” in line 10, add the words “for its review and the Owner’s approval.”

To Paragraph 2.07.A.1, after the word “Engineer,” in line 2, add the words “and Owner”. And after the word “Engineer” in line 4, add the words “and Owner.” And after the word “therefore” in line 8, add “The schedule shall not exceed time limits current under the Contract Documents, shall be revised at appropriate intervals as required by the conditions of the Work and Project, shall be related to the entire Project to the extent required by the Contract Documents, and shall provide for expeditious and practicable execution of the Work. A Contractor’s construction schedule and any and all updates shall be prepared and maintained by the Contractor using the Critical Path Method and shall contain a minimum

of 200 activities. The Contractor shall submit its schedules to the Owner and Engineer at regular intervals, not to exceed one month. Each submittal shall include, at a minimum, plots of bar charts showing progress of the Work, Total Float and Critical Paths, in addition to a listing of the supporting data organized in tabular form. The Contractor's construction schedule updates shall identify the Work completed to date based on completed activities as a percentage of the total Work."

To Paragraph 2.07.A.2, after the word "Engineer," in line 2, add the words "and Owner".

To Paragraph 2.07.A.3, after the word "Engineer," in line 2, add the words "and Owner".

Article 3 Revisions:

**3.07 Add the following:**

The Contract Documents are complementary; what is called for by one is as binding as if called for by all. In resolving conflicts, errors, and discrepancies, the documents shall be given precedence in the following order: Agreement, Specifications, Drawings. Within the specifications the order of precedence shall be as follows: Special Provisions, Instructions to Bidders, General Conditions, Technical Provisions. Figure dimensions on Drawings shall govern over scale/dimensions, and detailed Drawings shall govern over general Drawings. The Contractor assumes full responsibility for having familiarized itself with the nature and extent of the Contract Documents, work, locality, and local conditions that may in any manner affect the work to be done.

Article 4 Revisions:

**4.01 Availability of Lands**

Add the following:

- D. If the Contractor, by direct negotiation and bargaining with any land owner, lessee or tenant, has secured for himself any right to use more space or greater privileges in the space provided for purposes incidental to the performance of the Contract, he shall, upon request of the Owner's Representative, furnish to the Owner's Representative proper evidence that such additional right have been properly secured and assurance that no damage to or claim upon the Owner will arise there from. The Owner shall not be liable in any way for any expense incurred by the Contractor in securing any such right to use additional property.
- E. If access is provided by means of any road or driveway or through private lands, the Contractor shall permit the regular Owners or users thereof to use the same so far as it is consistent with the construction of the work. If any existing driveway or road is damaged by his use thereof, the Contractor, at its sole expense, shall at once restore it to as good condition as it would have been had he not used it. The Contractor and those under him using any private road or driveway must assume to use that road or driveway on an "as is" basis and use it at their own risk. Neither the Owner nor the land owner

shall be liable for damage to persons or property of the Contractor's forces arising from any defect in such road or driveway, except as such defect may be the consequence of negligence of the Owner or the land owner after the award of the Contract.

#### **4.05 Reference Points**

To Paragraph 4.05.A, after the word "Work," in line 4, add the words "The Contractor shall be entitled to rely on the accuracy of the information furnished by the Owner unless the Contractor has actual knowledge to the contrary."

### Article 5 Revisions:

#### **5.01 Performance, Payment, and Other Bonds**

To Paragraph 5.01.A, add "The Contractor shall deliver the executed, approved bonds to the Owner at the time of execution of this Contract. In the alternative, Contractor shall furnish Owner with an irrevocable, documentary standby letter of credit in the amount of the Contract sum. The letter of credit may be drawn upon by the Owner if a default under the Contract occurs and/or to pay any Liquidated Damages Amount. If the Owner draws on the letter of credit to pay any of the Liquidated Damages amounts, the Contractor shall remain liable for any remaining Liquidated Damages Amount after such draw(s). The letter of credit (a) shall be in a form and by a financial institution reasonably acceptable to the Owner, (b) shall be payable on sight draft, in partial draws, if applicable, to Owner without other conditions except for the beneficiaries certificate that it is entitled to draw thereon, (c) shall not expire prior to Final Completion of the Work, and (d) shall be for an initial term of one (1) year, which term shall be automatically renewable for subsequent one-year terms thereafter, or for an initial term of one (1) year with a provision that the Owner receive thirty (30) days prior written notice of the termination date of the letter of credit, at which time the Owner may draw on the letter of credit, whether or not a default under the Contract exists, prior to such termination date; provided, however, that such letter of credit shall be returned no later than thirty (30) days following Final Completion of all of the work. The Contractor shall deliver such executed, approved letter of credit to Owner at the time of the execution of this Contract."

#### **5.03 Certificates of Insurance**

To Paragraph 5.03.A, add "Contractor shall also deliver to Owner copies of each of the insurance policies required of Contractor under this Contract, including without limitation, declarations, and any other document evidencing types of coverage, limits of coverage, insureds, and additional insureds."

#### **5.04 Contractor's Liability Insurance**

Add the following:

- C. The insurance required by Paragraph 5.04 shall be written for not less than amounts set forth below or required by law, whichever coverage is greater. Coverages shall be maintained without interruption from date of commencement of the Work until date of final payment and termination of any coverage required to be maintained after final payment. Such coverages shall be maintained by insurance carriers acceptable to Owner and Owner's lender in all respects.
1. Workers' Compensation and Employer's Liability Insurance: Workers' Compensation limits shall not be less than those statutorily required in the State of Connecticut and shall include Employers Liability limits of liability of \$1,000,000 bodily injury per accident/employee; \$1,000,000 bodily injury per disease/employee; \$1,000,000 policy by disease;
  2. Commercial General Liability Insurance: Limits of liability shall not be less than Two Million dollars (\$2,000,000) per occurrence combined Bodily Injury and Property Damage and Four Million dollars (\$4,000,000) in the aggregate. The limits may be provided through a combination of Primary and Umbrella/Excess Liability policies acceptable to the Owner;
  3. Commercial Automobile Liability Insurance: Limits of liability shall not be less than Two Million dollars (\$2,000,000) per occurrence combined Bodily Injury and Property Damage. The limit may be provided through a combination of Primary and Umbrella/Excess Liability policies acceptable to the Owner;
  4. The Contractor shall, within 30 days of being awarded the contract, provide the Owner with copies of the insurance policies required of it under this contract, each of which names the Town of Windsor Locks as additional insureds.
  5. The amount of insurance contained in aforementioned insurance coverage shall not be construed to be a limitation of the obligation or liability on the part of the Contractor or any of its subcontractors under the provisions of this Contract or at law.
  6. The aforementioned insurance coverage outlined in this section and any other coverage that Contractor may consider necessary are the Contractor's sole responsibility and any deficiency in coverage or policy limits of the Contractor will be the sole responsibility of the Contractor.
  7. In the event of failure of the Contractor to furnish and maintain the aforementioned insurance and to furnish satisfactory evidence thereof, such failure shall constitute a breach of this Contract and the Owner shall have the right, in addition to any other rights, to immediately cancel and terminate this Contract without any further costs to the Owner or, at the Owner's option, to take out and maintain the same on behalf of the Contractor who agrees to furnish all necessary



information relative thereto and to pay the cost thereof to the Owner immediately upon presentation of a bill

- D. Insurance requirements shall also apply to all Subcontractors, and the Contractor shall not allow any Subcontractor to commence work until the Subcontractor's insurance has been obtained.

#### **5.06 Property Insurance**

Delete Paragraph 5.06.A.2, and replace with the following new Paragraph 5.06.A.2: "Property insurance shall be on an "all-risk" form and shall include, without limitation, insurance against earthquake, flood, windstorm, falsework, testing and startup, demolition occasioned by enforcement of any applicable legal requirements, and shall cover reasonable compensation for Engineer's and Contractor's services and expenses required as a result of such insured loss."

To Paragraph 5.06.B, in line 10, delete the words "and shall be listed as an insured or additional insured."

#### **5.07 Waiver of Rights**

To Paragraph 5.07.A, in line 14, delete the words "Owner and", replace the word "waive," with "waives", and after the word "against", add "Owner." From line 15, delete the word "their" and replace with "its". Add "The Contractor shall require of the subcontractors, sub-subcontractors, agents and employees of any of them, by appropriate agreements, written where legally required for validity, similar waivers each in favor of the Owner. The policies shall provide such waivers of subrogation by endorsement or otherwise. A waiver of subrogation shall be effective as to a person or entity even though that person or entity would otherwise have a duty of indemnification, contractual or otherwise, did not pay the insurance premium directly or indirectly, and whether or not the person or entity had an insurable interest in the property damaged."

Add the following:

- D. Claims for Consequential Damages. Except as otherwise provided in the Contract Documents, the Contractor and Owner waive Claims against each other for consequential damages arising out of or relating to this Contract. This mutual waiver includes:
  - 1. damages incurred by the Owner for rental expenses, for losses of use, income, profit, financing, business and reputation, and for loss of management or employee productivity or of the services of such persons; and
  - 2. damages incurred by the Contractor for principal office expenses including the compensation of personnel stationed there, for losses of financing, business and

reputation, and for loss of profit except anticipated profit arising directly from the Work.

This mutual waiver is applicable, without limitation, to all consequential damages due to either party's termination in accordance with Article 15. Nothing contained in this section 5.07 shall be deemed to preclude an award of liquidated non-consequential damages, when applicable, in accordance with the requirements of the Contract Documents."

#### Article 6 Revisions:

##### **6.01 Supervision and Superintendence**

To Paragraph 6.01.A, after the phrase "Contract Documents" in line 5, add "in a manner consistent with the degree of care and skill usually exercised by contractors experienced in projects of similar scope and in accordance with the standards of skill and care expected of contractors experienced in projects similar to the Project. Under no circumstances shall the quality and completeness of Work be less than recognized industry standards."

To Paragraph 6.01.B, add "The Superintendent shall be satisfactory to the Owner and the Owner shall have the right to request Contractor to dismiss from the Project any Superintendent whose performance is not satisfactory to Owner. In the event Owner and Contractor fail to agree as to whether such dismissal is warranted, the Engineer shall make such determination and both parties shall agree to abide by the decision of the Engineer. The Contractor shall not replace the Superintendent without the consent of the Owner, which consent shall not be unreasonably withheld."

##### **6.02 Labor; Working Hours**

To Paragraph 6.02.A, after the word "Site" in line 5, add "The Contractor shall be responsible to the Owner for acts and omissions of the Contractor's employees, Subcontractors and their agents and employees, and other persons or entities performing portions of the Work for or on behalf of the Contractor or any of its Subcontractors. If the Owner or Engineer has reasonable objection to an employee of the Contractor or any of its Subcontractors, the Contractor must submit an acceptable substitute person or entity to the Owner."

##### **6.04 Progress Schedule**

To Paragraph 6.04.A.1, after the words "Engineer for", add "review and Owner".

##### **6.06 Concerning Subcontractors, Suppliers, and Others**

To Paragraph 6.06.A, add "Unless otherwise stated in the Contract Documents or the proposal requirements, the Contractor, as soon as practicable after award of the Contract,

shall furnish in writing to the Owner the names of persons or entities (including those who are to furnish materials or equipment fabricated to a special design) proposed for each principal portion of the Work. The Owner will promptly reply to the Contractor in writing stating whether or not the Owner or the Engineer, after due investigation, has reasonable objection to any such proposed person or entity. Failure of the Owner or Engineer to reply promptly shall constitute notice of no reasonable objection.”

To Paragraph 6.06.G, add “Any part of the work performed for the Contractor by a Subcontractor shall be pursuant to a written Subcontract between the Contractor and Subcontractor. Copies of all Subcontractor proposals, and ultimately, subcontracts, shall, upon request of Owner, be submitted to Owner and Engineer.”

Add the following:

“H. The Contractor shall obtain lien waivers from Subcontractors and material suppliers upon payment to such parties and shall supply copies of the same to Owner promptly upon receipt thereof. If Contractor fails to comply with the provisions of this Paragraph 6.06.H, and for so long as such failure continues, Owner may make all payments attributable to a Subcontractor or material supplier co-payable to the Contractor and such Subcontractor or material supplier.”

## **6.08 Permits**

To Paragraph 6.08.A, add “The Contractor will perform and complete the Work in accordance with all requirements of law and with the Contract Documents and no work shall be undertaken until the Contractor has been issued all required permits. Contractor shall prosecute all work diligently to assure completion no later than the date specified therefore.”

## **6.09 Laws and Regulations**

To Paragraph 6.09.A, after the word “Work” in line 3, add “Contractor shall review the Contract Documents and notify the Owner and the Engineer of any discrepancy between building codes and regulations of which the Contractor has actual knowledge without independent investigation. The Contractor shall not violate any zoning, set-back or other locational requirements of applicable laws, codes or ordinances, or of any recorded covenants of which the Contractor has actual knowledge. If the Contractor observes or is told by any building inspector that portions of the Contract Documents are at variance with applicable laws, statutes ordinances, building codes, rules or regulations, the Contractor shall promptly notify the Engineer and Owner in writing, and necessary changes shall be accomplished by appropriate modification.”

Add the following:

“D. The Contractor shall be responsible to procure Certificate(s) of Occupancy from the authorities having jurisdiction.”

“E. The Contractor shall maintain policies of employment as follows:

1. The Contractor and the Contractor’s subcontractors shall not discriminate against any employee or applicant for employment because of race, religion, color, sex, or national origin. The Contractor shall take affirmative action to ensure that applicants are employed, and that employees are treated during employment without regard to their race, religion, color, sex, or national origin. Such action shall include, but not be limited to, the following: employment, upgrading, demotion or transfer; recruitment or recruitment advertising; layoff or termination; rates of pay or other forms of compensation; and selection for training, including apprenticeship. The Contractor agrees to post in conspicuous places, available to employees and applicants for employment, notices setting forth the policies of non-discrimination.
2. The Contractor and the Contractor’s Subcontractors shall, in all solicitations or advertisements for employees placed by them or on their behalf, state that all qualified applicants will receive consideration for employment without regard to race, religion, color, sex, or national origin.”

#### **6.11.A.1 Use of Site and Other Areas**

- A.1 “The exact limit of Work and equipment storage shall be verified and agreed to by Owner and Contractor in the field.”

#### **6.12 Record Documents**

To Paragraph 6.12.A, add “In the event that either party to this Agreement terminates the Agreement, the Contract Documents and Project files that were maintained in paper and electronic formats shall be the property of and reside with the Owner.”

#### **6.19 Contractor’s General Warranty and Guaranty**

To Paragraph 6.19.A, after the word “guarantee” in line 5, add “The Contractor warrants to the Owner and Engineer that materials and equipment furnished under the Contract will be of good quality and new unless otherwise required or permitted by the Contract Documents, that the Work will be free from defects not inherent in the quality required or permitted, and that the Work will conform to the requirements of the Contract Documents. Work not conforming to these requirements, including substitutions not properly approved and authorized, may be considered defective. If required by the Owner or Engineer, the Contractor shall furnish satisfactory evidence as to the kind and quality of materials and equipment. The Contractor further warrants and represents that:

1. The Contractor is financially solvent, able to pay all debts as they mature and possessed of sufficient working capital to complete the work and perform all obligations under the Contract Documents;
2. the Contractor is able to furnish the tools, materials, supplies, equipment and labor required to complete the work and perform all obligations under the Contract Documents, and has sufficient experience and competence to do so;
3. the Contractor is authorized to do business in the state where the Project is located and is properly licensed by all necessary governmental, public and other authorities having jurisdiction over the Contractor and the Project;
4. the persons executing the Contract Documents are authorized to do so;
5. the Contractor has visited the site of the Project and become familiar with the Contract Documents and the conditions of the site, and knows of no reason why the work cannot be performed as set forth in the Contract Documents;
6. The Contractor shall warrant all Work for a period of one (1) year after Final Completion; and
7. The Contractor shall assign any extended warranties (in excess of the Contractor's one (1) year warranty) on equipment and materials furnished as part of the Work to the Owner."

#### **6.20 Indemnification**

To Paragraph 6.20.A, after the word "performance" in line 10, add "or non-performance".

Article 7 Revision:

#### **7.01 Related Work at Site**

To Paragraph 7.01.C, after the word "Engineer" in line 4, add "and Owner."

Article 8 Revision:

#### **8.11 Evidence of Financial Arrangements**

Delete Paragraph 8.11.A in its entirety.

Article 9 Revision:

#### **9.04 Authorized variations in Work**

To Paragraph 9.04.A, after the word “Engineer,” in line 1, add the words “after having received approval from the Owner,”.

#### **9.08 Decisions on Requirements of Contract Documents and Acceptability of Work**

Delete Paragraph 9.08.A in its entirety.

#### **9.09 Limitations on Engineer’s Authority and Responsibility**

Add the following:

“F. Except as otherwise provided in the Contract Documents or when direct communications have been specially authorized, the Owner and Contractor shall endeavor to communicate with each other through the Owner’s designated representative about matters arising out of or relating to the Contract. Communications by and with the Engineer’s consultants shall be through the Engineer. Communications by and with Subcontractors and material suppliers shall be through the Contractor. Communications by and with separate contractors shall be through the Owner’s designated representative.”

Article 10 Revision:

#### **10.05 Claims**

Delete Paragraph 10.05.E in its entirety.

Article 11 Revisions:

Add the following:

#### **11.04 Equipment Rental Rates Not Otherwise Covered**

With regard to rental rates applicable to work not covered by either Lump Sum pay items or Unit Adjustments, for any power-operated machinery, trucks or equipment, necessary to use, the Engineer will allow the Contractor the rental rate set forth in the most current edition of the “Rental Rate Blue Book,” including all Rate Adjustment Tables and amendments, as published by Dataquest, Inc. of San Jose, California in effect at the time the work is performed for Contractor-owned equipment or at a lower rate, if submitted by the Contractor.

A. Should the proper completion of the work require equipment of a type not covered by the above-mentioned schedule, the Engineer will allow Contractor a reasonable rental rate which shall be based on that prevailing in the area of the work and shall be agreed upon in writing before the work is begun. However, the Contractor shall show the sources for the rates he has proposed.

- B. For power-operated machinery, truck or equipment, which the Contractor must obtain by rental, he shall inform the Engineer of his need to rent the equipment prior to using it on the work. He shall be paid the actual rental for the equipment, provided that rate does not exceed the rental rate set forth in the "Rental Rate Blue Book", including all Rate Adjustment Tables and amendments as published by Dataquest, Inc. The Contractor shall provide a copy of the paid receipt for the rental expense incurred.
- C. The estimated operating cost per hour will apply only to the actual time the equipment is operating. Operators will be paid as stated hereinbefore for labor except for certain trucks listed in the "Rental Rate Blue Book" as published by Dataquest, Inc. which show the operators to be included.
- D. For rented equipment not owned by the Contractor or a subsidiary of the Contractor, the following rates shall apply:
  - 1. The daily rate per hour shall apply when the equipment is specifically assigned to the work by the Engineer for a period of 7 consecutive calendar days or less.
  - 2. The weekly rate per hour shall apply when the assigned time exceeds 7 consecutive calendar days but does not exceed 21 calendar days.
  - 3. The monthly rate per hour shall apply when the assigned time exceeds 21 consecutive calendar days.
- E. For Contractor-owned equipment or equipment rented or obtained from a subsidiary of the Contractor, the maximum hourly rate to be used shall be the monthly rate as set forth in the current edition of the "Rental Rate Blue Book", including Rate Adjustment Tables and amendments as published by Dataquest, Inc., divided by 176 (176 working hours per month).

Article 12 Revisions:

**12.03 Delays**

To Paragraph 12.03.B, after the words "equitable adjustment in" in line 6, delete the words "Contract Price or the", and after the words "Contract Times, delete the words ", or both". Add "Such an adjustment to the Contract Time shall be the Contractor's sole and exclusive remedy for the delays discussed in this paragraph 12.03."

To Paragraph 12.03.C, after the words "Contract Times" in line 9, add the words "and only to the extent that the critical path to the Project Schedule is extended."

Article 13 Revision:

**13.07 Correction Period**

To Paragraph 13.07.A, after the words “the date of” in line 1, delete the words “Substantial Completion”, and replace with the words “Final Completion.”

Article 14 Revisions:

**14.01 Schedule of Values**

To Paragraph 14.01.A, after the words “acceptable to Engineer” in line 4, add the words “and Owner.”

**14.02.C Payment Becomes Due**

To Paragraph 14.02.C.1, add “In no event shall the Owner be obligated to pay the Contractor for more than the amount certified by the Engineer for each Application for Payment, plus any pending change orders that the Owner agreed to approve.”

Article 15 Revisions:

Delete the word “persistent” from Article 15.0.2.A.1

**15.03 Owner may Terminate for Convenience**

To Paragraph 15.03.A.1, delete from line 3 the words “including fair and reasonable sums for overhead and profit on such Work.”

To Paragraph 15.03.A.2, delete from line 5 the words “plus fair and reasonable sums for overhead and profit on such expenses.”

To Paragraph 15.03.A.4, add “, but no overhead and profit on work not executed.”

Add the following:

“C. In no event shall the Contractor or any Subcontractor employed on the Project be entitled to profit, overhead, or damages on work that was not performed as of the date of termination, regardless of the reasons for termination.”

“D. Upon receipt of written notice from the Owner of such termination for the Owner’s convenience, the Contractor shall:

1. cease operations as directed by the Owner in the notice;



2. take actions necessary, or that the Owner may direct, for the protection and preservation of the Work;
3. except for Work directed to be performed prior to the effective date of termination stated in the notice, terminate all existing subcontracts and purchase orders and enter into no further subcontracts and purchase orders; and
4. provide a detailed inventory to the Owner that indicates the value, nature, and description of all material, labor, and equipment supplied as of the date of termination.”

Article 16 Revisions:

**16.01 Methods and Procedures**

Delete Paragraph 16.01.A, and replace with the following new Paragraph 16.01.A.:

“Owner, in its sole discretion, may request mediation of any Claim submitted to Engineer for a decision under Paragraph 10.05. The mediation will be governed by the Construction Industry Mediation Rules of the American Dispute Resolution Center, New Britain, Connecticut, currently in effect.”

Delete Paragraph 16.01.C, and replace with the following new Paragraph 16.01.C:

“Any Claim arising out of or related to the Contract, except Claims relating to aesthetic effect and except those waived in the Contract Documents, shall, at the sole discretion of the Owner, be subject to arbitration. If the Owner chooses to Arbitrate the Claims, the arbitration shall be in accordance with the Construction Industry Arbitration Rules of the American Dispute Resolution Center, New Britain, Connecticut, currently in effect. The demand for arbitration shall be filed in writing with the other party to the Contract and with the American Dispute Resolution Center, and a copy shall be filed with the Engineer.”

Article 17 Revisions:

Add the following:

**17.07 Time for Completion and Liquidated Damages:**

- A. It is hereby understood and mutually agreed, by and between Contractor and Owner, that the date of beginning and the time for completion as specified in the Agreement of the work to be done hereunder are essential conditions of this Contract; and it is further mutually understood and agreed that the Work embraced in this Agreement shall be commenced on a date to be specified in the Notice to Proceed.

- B. Contractor agrees that said Work shall be prosecuted regularly, diligently and uninterruptedly at such rate of progress as will insure full completion thereof within the time specified. It is expressly understood and agreed, by and between Contractor and Owner, that the time for the completion of the Work described herein is a reasonable time for the completion of the same, taking into consideration the average climatic range and conditions in this locality.
- C. If said Contractor shall neglect, fail or refuse to complete the Work within the time herein specified, or any proper extension thereof granted by Owner, then the Contractor does hereby agree to pay to Owner the amount specified in the Agreement, not as a penalty but as Liquidated Damages for such breach of Agreement, for each and every calendar day that Contractor shall be in default after the time stipulated in the Agreement for completing the Work.
- D. The said amount is fixed and agreed upon by and between Contractor and Owner because of the impracticality and extreme difficulty of fixing and ascertaining the actual damages Owner would in event sustain, and said amount shall be retained from time to time by the Owner from current periodical estimates.

**TAB F**

Special Provisions



## **SPECIAL PROVISIONS**

### **DESCRIPTION:**

These Special Provisions contain information and requirements that the Contractor shall adhere to throughout the prosecution of work under this Contract. Also, included within these Special Provisions, are the individual Technical Specifications.

### **GENERAL INFORMATION:**

The Owner is the Town of Windsor Locks. The Engineer is Anchor Engineering Services, Inc. (Anchor). The project sites are located on Coolidge Street and Taft Lane, Windsor Locks, Connecticut. This project consists of roadway improvements described on the Contract Plans and Specifications.

### **COORDINATION OF WORK:**

A portion of work associated with this project is to be performed by the Owner. The Contractor shall coordinate with the Owner and its agent accordingly.

The Contractor shall refer to the Contract drawings which indicate the portion of work to be performed by the Owner (i.e., noted as "By Others" or "Not in Contract") and/or as described herein.

### **CONTRACT SUPERVISION:**

The Contractor shall have a supervisor onsite at all times when work is being performed throughout the entire course of this Contract. This person shall be the responsible individual in charge onsite whom the Engineer shall coordinate all onsite activities (ie. inspections, etc.). The Contractor shall identify this person at the pre-construction meeting and provide contact information (including emergency contact information ie. outside of onsite work hours).

### **SCHEDULE:**

The contract time for each project is **forty-five (45)** consecutive calendar days, starting on the Notice to Proceed date. The intended project schedule is as follows:

Bids Due:	June 19, 2019
Notice of Award:	June 28, 2019
Contract Signing/Notice to Proceed:	July 12, 2019
Substantial Completion	August 26, 2019

### **LIQUIDATED DAMAGES:**

The Contractor is hereby notified that liquidated damages in the amount of five hundred dollars (\$500.00) per consecutive calendar day apply to this project in order to help ensure a timely completion.

**LICENSES:**

The Contractor and its subcontractors performing the work shall hold a relevant license issued by the State of Connecticut. All work under this Contract shall be subject to the rules and ordinances of the State of Connecticut, and the Town of Windsor Locks.

**PERMITS:**

The Contractor is responsible for obtaining all necessary permits, including all associated costs, required for this Contract work. Additionally, the Contractor is hereby notified that the project sites are located on Coolidge Street and Taft Lane, Windsor Locks CT.

**CALL-BEFORE-YOU-DIG (CBYD):**

The Contractor is hereby notified that he shall contact Call-Before-You-Dig (CBYD) 1-800-922-4455 [www.cbyd.com](http://www.cbyd.com) and obtain authorization prior to start of work as required by law.

**PORTABLE CHEMICAL TOILET FACILITY:**

The Contractor is hereby notified that the Contractor shall provide adequate number of portable chemical toilets per OSHA for the Contractor's use to support this project. There shall be no separate measurement and payment for chemical portable toilet facilities.

**CONSTRUCTION STAKING & LAYOUT:**

The Contractor is hereby notified that construction stakeout shall be performed by the Town's agent; Anchor Engineering Services, Inc.

**MATERIALS & INSTALLATIONS:**

The Contractor shall furnish and install all materials necessary to complete this project unless specifically otherwise noted. The Contractor shall furnish all materials to meet or exceed those specified. The Contractor shall install all materials in accordance with both the material manufacturer's recommendations and accepted industry standard practices.

**INSPECTION:**

The Contractor is hereby notified that the Town's agent, Anchor Engineering, Inc., shall perform construction inspection to support this project.

**TESTING:**

The Contractor is hereby notified that the Town's agent, Anchor Engineering Services, Inc. shall perform all in place soils and bituminous concrete density tests as deemed necessary to ensure proper compaction as well as cast-in-place concrete tests as deemed necessary to ensure proper concrete strength.

**DUMPSTERS:**

The Contractor is hereby notified that the Contractor shall furnish dumpsters as necessary for disposing all construction and demolition waste materials that are generated by this project. There shall be no separate measurement and payment for dumpsters.

**FINAL CLEANING:**

The Contractor shall be responsible for disposing of all construction and demolition waste materials that are generated by this project in accordance with all local, state, and federal regulations. The Contractor shall perform an overall final cleaning of the entire Contract work prior to and in preparation for the Owner's final inspection. Following the Owner's final inspection and acceptance of the entire Contract work, the Contractor shall remove all tools and equipment from Owner's property. There shall be no separate measurement and payment for final cleaning.

**WARRANTY & GUARANTEE:**

The Contractor shall warranty and guarantee all work under this Contract for a minimum period of one year from the date of final payment. The Contractor performing the work shall secure warranties and guaranties from its subcontractors for their parts of the work under this Contract.

**CONSTRUCTION SEQUENCE:**

A suggested construction sequence is listed on the plans. The Contractor is hereby notified that this is meant to serve as a guideline only, and that the Contractor shall be solely responsible for determining an actual construction sequence schedule to meet the Contract terms.

**Additionally, the Contractor is hereby notified that they shall submit a construction schedule to the Owner for approval.**

**SUBMITTALS:**

The Contractor shall submit (3) copies of each required submittal to the Town or its agent for approval, prior to construction. The Town or its agent will endeavor to respond with their approval and/or review comments within a (2) week period of their receipt of said submittals. The Contractor shall make submittals that are specifically described within the individual technical specifications.

**TECHNICAL SPECIFICATIONS:**

The technical specifications that form part of these special provisions are included on the following pages.





# **TAB G**

Technical Specifications



**TECHNICAL SPECIFICATIONS**  
**TABLE OF CONTENTS**

<u>SECTION</u>	<u>TITLE</u>
01 01 00	Hazardous Materials Abatement General Conditions
01 01 60	Hazardous Materials Scheduling and Phasing
01 70 01	Hazardous Materials Contract Closeout
01 11 00	Summary of Work
01 33 00	Submittals
01 43 00	Quality Control and Assurance
01 45 23	Testing Laboratory Services
01 55 26	Maintenance and Protection of Traffic
01 55 27	Trafficmen (Special Duty Police)
01 57 00	Temporary Controls
01 57 13	Sediment and Erosion Control
01 57 20	Dust Control
31 23 00	Excavation and Site Work
31 23 13	Formation of Subgrade
02 08 00	Asbestos Abatement
31 23 19	Dewatering, Control and Diversion of Water
31 23 33	Trench Excavation
31 23 35	Bedding for Pipes & Structure
32 01 15	Saw Cut Existing Pavement
32 11 16	Subbase
32 11 23	Processed Aggregate Base
32 12 16	Bituminous Concrete
33 31 00	Polyvinyl Chloride (PVC) Gravity Sanitary Sewer
33 39 00	Sanitary Utility Sewerage Structures

**SECTION 01 01 00**  
**HAZARDOUS MATERIALS ABATEMENT GENERAL CONDITIONS**

**PART 1 - GENERAL**

1.1 RELATED DOCUMENTS

- A. Drawings and general provisions of the Contract, including General and Supplementary Conditions and other Division 01 Specification Sections, apply to this Section.

1.2 SECTION INCLUDES

- A. Abatement Contractor's use of Site and premises.
- B. Work Sequence.

1.3 ASBESTOS ABATEMENT CONTRACTOR (AAC) QUALIFICATIONS

- A. All bidders shall submit a record of prior experience in asbestos abatement projects, listing no less than three (3) completed jobs in the past year, with all projects of similar size and scope. The Asbestos Abatement Contractor (AAC) shall list the experience and training of the Site Supervisor and all on-site workers. The information that shall be included is as follows:
  - 1. Project Name and Address
  - 2. Owner's Name and Address
  - 3. Architect/Consultant/Construction Manager
  - 4. Contract Amount
  - 5. Date of Completion
  - 6. Extras and Change Orders
- B. The AAC selected must appear on the approved list of Asbestos Abatement Contractors on file at the State of Connecticut Department of Public Health (CTDPH).
- C. Submit a written statement regarding whether the AAC has ever been found out-of-compliance with federal or state asbestos and/or lead regulations pertaining to worker protection, removal, transport, or disposal.

1.4 CONTRACTORS (AAC) USE OF SITE AND PREMISES

- A. Limit use of Site and premises as follows:
  - 1. Traffic.
  - 2. Work by Other Trades.
- B. Coordinate use of the premises under direction of Owner/Engineer.
- C. Assume full responsibility for protection and safekeeping of products under this Contract.

1.5 WORK PHASING

- A. Work under this project may be performed in phases to accommodate Owner's requirements, road access and construction phases. Coordinate abatement schedule and operations with the Owner, Engineer, Owner's Consultant and other trades.

1.6 OWNER'S OPERATIONS

- A. Schedule the Work to accommodate this requirement.
- B. Maintain means of egress.
- C. Coordinate Work with the Owner, Engineer and the Owner's Consultant.
- D. Coordinate road and lane closures, if required, with the Owner and local police department.

1.7 DAILY INSPECTIONS

- A. The AAC shall carefully check his/her own work and that of any Subcontractor as the work is being performed. Unsatisfactory work shall be corrected immediately.
- B. Upon request of the AAC, the Owner's Consultant will promptly make a thorough inspection of the work area to confirm all asbestos containing materials have been removed.
- C. All inspections and material sampling required for asbestos abatement compliance will be performed by the Owner's Consultant on a daily basis.

1.8 CLEANING

- A. Throughout the construction period, the AAC shall maintain the Site free of rubbish, debris, surplus materials, and other items not required for the Work. Remove such material from the Site daily to prevent accumulations. Remove all construction debris from work areas, and remove all hazardous waste and asbestos waste as required by the most current federal, state, and local regulations and the requirements of the specifications.

1.9 ADDITIONAL GENERAL REQUIREMENTS

- A. The AAC shall employ a competent and English-speaking Asbestos Abatement Supervisor with at least three (3) years experience on projects of similar scope and magnitude. The Supervisor shall be responsible for all work involving hazardous materials abatement as described in the specifications and defined in the applicable regulations, and have full time daily supervision of the same. The Supervisor shall be the "Competent Person" as defined by OSHA regulations.
- B. The AAC shall allow the work of this contract to be inspected, if required, by local, state, federal, and any other authorities having jurisdiction over such work. The AAC shall immediately notify the Owner and Owner's Consultant and shall maintain written evidence of such inspection for review by the Owner and Owner's Consultant.
- C. The AAC shall incur the cost of all fines resulting from regulatory non-compliance as issued by federal, state, and local agencies. The AAC shall incur the cost of all work requirements mandated by federal, state, and local agencies as a result of regulatory non-compliance or negligence.
- D. The AAC shall immediately notify the Owner and Owner's Consultant of the delivery of all permits, licenses, certificates of inspection, of approval or occupancy, etc., and any other such instruments required under codes by authorities having jurisdiction, regardless

to who issued, and shall cause them to be displayed to the Owner and Owner's Consultant for verification and recording.

**PART 2 - PRODUCTS (Not Used)**

**PART 3 - EXECUTION (Not Used)**

**END OF SECTION**

**SECTION 01 01 60**  
**HAZARDOUS MATERIALS SCHEDULING AND PHASING**

**PART 1 - GENERAL**

1.1 RELATED DOCUMENTS

- A. Drawings and general provisions of the Contract, including General and Supplementary Conditions and other Division 01 Specification Sections, apply to this Section.

1.2 GENERAL REQUIREMENTS

- A. The abatement work for this project may be conducted in phases. The work of this project shall begin upon receipt of the “Notice to Proceed” from the Owner/ Engineer. A Pre-Construction Meeting shall be scheduled by the Owner/ Engineer and must be attended by the Asbestos Abatement Contractor (AAC) and any Sub-Contractors. The assigned Site Supervisor(s) must also attend this meeting.
- B. A working schedule for each phase of work shall be presented by the AAC at the Pre-Construction Meeting. Variations, amendments, and corrections to the presented schedule will be discussed and the Owner/ Engineer will inform the AAC of additions or changes in the scheduling requirements for the project.
- C. As a result of the Pre-Construction Meeting, the AAC shall submit a revised schedule no later than three (3) business days from the Pre-Construction Meeting. Upon approval from the Owner/Consultant/ Engineer, the AAC will receive a “Notice to Proceed” with the work of the Contract.
- D. Refer to all other applicable sections of the specification for coordination with other trades. The AAC shall coordinate the abatement work with all other activities at the Site.

1.3 TIME FOR COMPLETION AND WORKING HOURS

- A. Upon award of contract from the Owner, the AAC shall immediately order materials, supplies, and components for the work of this project.
- B. The AAC shall begin the work immediately upon receipt of the written “Notice to Proceed” from the Owner. The date of the commencement of the work is termed the “Construction Start Date.” The AAC will be required to complete all work of this Contract within the time period stipulated in the finalized schedule. The last day in the schedule is termed as “Contract Completion Date.”
- C. Work hours will be established in coordination with the Owner/Consultant/ Engineer.
- D. Any extra hours or days per week worked by the AAC or Sub-Contractors shall be at no extra cost to the Owner. Denial of extra hours or days per week by the Owner shall not be grounds for extra time allotted to the overall Contract time. The AAC shall be responsible for all overtime payment to cover Consultant’s overtime fees for work performed above and beyond normal working hours.

**PART 2 - PRODUCTS (Not Used)**

**PART 3 - EXECUTION (Not Used)**

**END OF SECTION**



**SECTION 01 70 01  
HAZARDOUS MATERIALS CONTRACT CLOSE OUT**

**PART 1 - GENERAL**

1.1 RELATED DOCUMENTS

- A. Section 02 08 00 – Asbestos Abatement

1.2 GENERAL PROVISIONS

- A. General Provisions of the Contract, including General and Supplementary Conditions and Division 1 Specification Sections, apply to this Section.

1.3 FINAL CLEANING

- A. Unless otherwise specified under Sections of this Specification, the Asbestos Abatement Contractor (AAC) shall perform final cleaning operations as herein specified prior to final inspection.
- B. Maintain the project site free from accumulations of waste, debris and rubbish caused by operations. At the completion of the work, remove waste materials, rubbish, tools, equipment, machinery and surplus materials, and clean all sight-exposed surfaces; leave the project clean and ready for work of other trades.
- C. Cleaning shall include all surfaces, interior and exterior, in which the AAC has had access.
- D. Use only those materials that will not create hazards to health or property.

1.4 ABATEMENT CLOSEOUT DOCUMENTS

- A. Submit to the Owner and Owner's Consultant, final completed hard copies, via mail, all asbestos Waste Shipment Records (WSR), signed by all transporters and the designated disposal site owner/operator. WSR's shall be submitted to the Owner's Consultant within thirty-five (35) calendar days from shipment of waste from Site.
- B. Submit to the Owner and Owner's Consultant the results of all personal air sampling, AAC site logs and containment access logs generated during abatement work.
- C. **Final payment will be withheld until receipt of all the above documentations to Owner's Consultant's satisfaction.**

**PART 2 - PRODUCTS (Not Used)**

**PART 3 - EXECUTION (Not Used)**

**END OF SECTION**

**SECTION 01 11 00  
SUMMARY OF WORK**

**PART 1 - GENERAL**

**1.01 DESCRIPTION**

- A. The entire scope of work covered under these Contract documents includes removing sections of existing pvc and asbestos cement pipe (ACP) that are known to be sagging and replacing the sections with new SDR-35 PVC pipe. Additionally, one sanitary manhole will be replaced.
- B. The Contractor shall support any utilities that will be crossed by the piping to be repaired in accordance with generally accepted practices in order to protect utilities as necessary to prevent damage.
- C. The Contractor shall make themselves aware of all requirements associated with handling and cutting ACP piping and shall conform to all applicable rules and regulations governing such work.
- D. The Contractor shall provide for erosion and sedimentation control through the installation and maintenance of inlet sediment control devices as well maintain dust control as required.
- E. The Contractor shall not be allowed to temporarily disrupt the flow of wastewater through the work area and shall provide adequate pumping system as necessary to prevent any disruptions in flow. Prior to the initiation of work, the Contractor shall provide a wastewater management plan for review and approval by the Town. This plan shall document in detail the Contractor's proposed means and methods for maintaining sewer service in the project area.
- F. The Contractor shall provide for maintenance and protection of traffic at all times. No road closures will be permitted and the Contractor will be required to maintain access to all adjacent properties, including residential and park land uses.
- G. The work shall include the installation of temporary pavement over the excavated trenches, as detailed on the Contract Plans, however final pavement restoration will not be required. Should settlement of the trench occur, however, the Contractor shall be required to return to the site to remove the temporary pavement, repair the settlement, and reinstall temporary pavement.

**1.02 CONTRACT**

- A. Complete the entire scope of work under a lump sum price Contract with additional unit cost items as noted on the bid proposal form and in accordance with the Contract Documents.

**PART 2 - PRODUCTS**

Not Applicable

**PART 3 - EXECUTION**

Not Applicable

**SECTION 01 33 00  
SUBMITTALS**

**PART 1 - GENERAL**

1.01 DESCRIPTION

A. Work under this specification covers the following work:

- Submittal procedures
- Required submittals
- Construction progress schedules
- Proposed products list
- Shop drawings
- Product data
- Samples
- Manufacturers' instructions
- Manufacturers' certificates
- Operation and Maintenance Data
- Record Drawings (As-builts)
- Any Other Information Required to be Submitted by the Contractor in Accordance with the Contract Documents

**PART 2 - PRODUCTS**

Not Applicable.

**PART 3 - EXECUTION**

3.01 SUBMITTAL PROCEDURES

- A. Each submittal shall be accompanied with a transmittal letter and shall include six copies for review and distribution by the Owner.
- B. Contractor shall sequentially number the transmittal forms. Resubmittals to have original number with an alphabetic suffix.
- C. Identify Project, Contractor, Subcontractor or supplier; pertinent Drawing sheet and detail number(s), and specification Section number, as appropriate.
- D. Apply Contractor's stamp, signed or initialed certifying that review, verification of products required, field dimensions, adjacent construction Work, and coordination of information, is in accordance with the requirements of the Work and Contract Documents.

- E. Schedule submittals to expedite the project.
- F. Identify variations from Contract Documents and Product or system limitations which may be detrimental to successful performance of the completed Work.
- G. Provide space for Contractor and Engineer review stamps.
- H. Revise and resubmit submittals as required, identify all changes made since previous submittal.
- I. Distribute copies of reviewed submittals to concerned parties. Instruct parties to promptly report any inability to comply with provisions.

### 3.02 REQUIRED SUBMITTALS

- A. The Contractor shall provide submittals in accordance with the requirements specified herewithin for the following items:
  - 1. All components of the installation as required by these specifications or the Owner.
  - 2. Drawings of proposed installation if different from Contract Drawings.

### 3.03 CONSTRUCTION PROGRESS SCHEDULES

- A. Submit initial progress schedule in duplicate within 10 days after date of Owner-Contractor agreement for Owner's review.
- B. Revise and resubmit as required.
- C. Submit revised schedules with each Application for Payment, identifying changes since previous version.
- D. Show complete sequence of construction by activity, identifying Work of separate stages and other logically grouped activities. Indicate the early and late start, early and late finish, float dates, and duration.
- E. Indicate estimated percentage of completion for each item of Work at each submission.
- F. Indicate submittal dates required for shop drawings, product data, samples, and product delivery dates, including those furnished by Owner.

### 3.04 PROPOSED PRODUCTS LIST

- A. Within 10 days after date of Owner-Contractor agreement, submit complete list of major products proposed for use, with name of manufacturer, trade name, and model number

for each product.

- B. For products specified only by reference standards, give manufacturer, trade name, model or catalog designation, and reference standards.

### 3.05 SHOP DRAWINGS

- A. Submit the number of copies which Contractor requires, plus five copies which will be retained by Owner.
- B. After review distribute in accordance with Article on Procedures above and for record documents.

### 3.06 PRODUCT DATA

- A. Submit the number of copies which the Contractor requires, plus five copies which will be retained by the Owner.
- B. Mark each copy to identify applicable products, models, options, and other data. Supplement manufacturers' standard data to provide information unique to this project.
- C. After review, distribute in accordance with Article on Procedures above and provide copies for Record Documents.

### 3.07 SAMPLES

- A. Submit samples, when specified in individual specification sections, to illustrate functional and aesthetic characteristics of the product, with integral parts and attachment devices. Coordinate sample submittals for interfacing work.
- B. Submit the number of samples specified in individual specification sections; one of which will be retained by Owner.

### 3.08 MANUFACTURER'S INSTRUCTIONS

- A. When specified in individual specification sections, submit manufacturers' printed instructions for delivery, storage, assembly, installation, start-up, adjusting, operation and maintenance and finishing, in quantities specified for product data.
- B. Identify conflicts between manufacturers' instructions and Contract Documents.

### 3.09 MANUFACTURER'S CERTIFICATES

- A. When specified in individual specification sections, submit manufacturers' certificate to Owner for review, in quantities specified for product data.

- B. Indicate material or product conforms to or exceeds specified requirements. Submit supporting reference data, affidavits, and certifications as appropriate.
- C. Certificates may be recent or previous test results on material or product, but must be acceptable to Owner.

### 3.10 RECORD DRAWINGS (AS-BUILTS)

- A. Submit record drawings in accordance with the applicable requirements of the Owner as specified within the Contract Documents for all permanent installation work.

**END OF SECTION**

**SECTION 01 43 00**  
**QUALITY CONTROL AND ASSURANCE**

**PART 1 - GENERAL**

1.01 DESCRIPTION

A. Work includes:

1. Quality assurance and control of installation
2. References
3. Field samples
4. Manufacturers' field services and reports

B. RELATED WORK

2. Section 01 45 23 - Testing Laboratory Services
3. All individual Technical Specifications.

1.02 QUALITY ASSURANCE

- A. Monitor quality control over suppliers, manufacturers, products, services, site conditions, and workmanship, to produce Work of specified quality.
- B. Comply fully with manufacturers' instructions, including each step in sequence.
- C. Should manufacturers' instructions conflict with Contract Documents, request clarification from Engineer before proceeding.
- D. Comply with specified standards as a minimum quality of the Work except when more stringent tolerances, codes, or specified requirements indicate higher standards or more precise workmanship.
- E. Perform work by persons qualified to produce workmanship of specified quality.
- F. Secure products in place with positive anchorage devices designed and sized to withstand stresses, vibration, physical distortion or disfigurement.
- G. Conform to reference standard by date of issue current on date specified in product Sections.
- H. Obtain copies of standards when required by Contract Documents.
- I. Should specified reference standards conflict with Contract Documents, request clarification from Engineer before proceeding.

- J. The contractual relationship of the parties to the Contract shall not be altered from the Contract Documents by mention or inference otherwise in any reference documents.
  
- K. When specified in individual specification sections, the contractor shall require material or product suppliers or manufacturers to provide qualified staff personnel to observe site conditions, conditions of surfaces and installation, quality of workmanship, start-up of equipment, and test, adjust and balance equipment as applicable, and to initiate instructions when necessary.

#### 1.04 SUBMITTALS

None

### **PART 2 - PRODUCTS**

#### 2.01 GENERAL

Not Applicable.

### **PART 3 - EXECUTION**

#### 3.01 GENERAL

Not Applicable.

**END OF SECTION**



**SECTION 01 45 23**  
**TESTING LABORATORY SERVICES**

**PART 1 - GENERAL**

1.01 DESCRIPTION

- A. The Owner will select and will pay for an Independent Testing Laboratory to perform inspections and in placetesting as required by the Contract Documents. The Contractor shall engage the services of the designated laboratory. The cost of laboratory testing which is considered to be the Contractor's responsibility, includes, but not limited to testing required to demonstrate material quality is in compliance with the Contract Documents.
- B. The Contractor shall employ the services of a separate qualified laboratory for additional samples and tests required by the Contractor beyond the specified requirements. The Owner will not pay for any additional Contractor testing required to fulfill the intent of these contract documents. Costs associated with re-testing after results of initial testing indicates non-conformance with the plans or Specifications shall be the responsibility of the Contractor.
- C. The Contractor shall arrange for any inspections required by the Town officials. The Contractor shall bear the costs of any such inspections.
- D. The Testing Laboratory shall demonstrate in providing comparable services to those specified in the Contract Documents.

1.02 RELATED WORK

- A. Section 01 43 00 - Quality Control and Assurance
- B. Section 31 23 00 - Excavation and Site Work
- C. Section 31 23 13 - Formation of Subgrade
- D. Section 31 23 33 - Trench Excavation
- E. Any other testing required by one or more of the various Technical Specification Sections of the Contract Documents and not itemized above.

1.03 QUALITY ASSURANCE

- A. Comply with the requirements of ANSI/ASTM E329 and ANSI/ASTM D3740 – latest revisions.
- B. All testing laboratories shall be licensed/authorized to operate in the State of Connecticut.
- C. Testing laboratories shall maintain a full time CT Registered Engineer on staff to review services.

- D. Testing Equipment: Calibrated at reasonable intervals with devices of an accuracy traceable to either the National Bureau of Standards (NBS) Standards or accepted values of natural physical constants. All testing equipment used on this project shall have been calibrated within the last thirty (30) calendar days prior to the date of performing the Contract required testing.

#### 1.04 SUBMITTALS

- A. Prior to the start of work, submit the name, address, and telephone number and names of full time CT Registered Professional Engineer and responsible officer of the laboratory required by and to be paid for by the Contractor.
- B. Submit copy of report of laboratory facilities inspection made by Materials Reference Laboratory of NBS during most recent tour of inspection, with memorandum of remedies of any deficiencies reported by the inspection. Submit evidence of calibration in conformance with Part 1.02.D above.

#### 1.05 LABORATORY RESPONSIBILITIES

- A. Test the samples submitted by the Contractor.
- B. Provide qualified personnel at site after due notice; cooperate with Engineer and Owner in performance of services.
- C. Perform specified inspection, sampling, and testing of products.
- D. Ascertain compliance of materials and mixes with requirements of Contract Documents.
- E. Promptly notify Engineer, Owner and Contractor of observed irregularities or non-conformance of work or products.
- F. Perform additional inspections and tests required by Engineer.

#### 1.06 LABORATORY DUTIES

- A. Cooperate with Owner, and Contractors, provide qualified personnel promptly on notice. Perform specified inspections, sampling and testing of materials and methods of construction; ascertain compliance with requirements of Contract Documents.
- B. Promptly notify Owner, and Contractors of irregularities or deficiencies of work, which are observed during performance of services. Submit two (2) copies of reports of inspections and tests to the Engineer, addressed to the Owner, including:
  - 1. Date issued
  - 2. Project title and number
  - 3. Testing Laboratory name and address

4. Name and signature of Inspector
  5. Date of inspection or sampling
  6. Record of temperature and weather
  7. Date of test
  8. Identification of product and specification section
  9. Location in project
  10. Type of inspection or test
  11. Observations regarding compliance with Contract Documents.
- C. Laboratory is not authorized to release, revoke, alter or enlarge on requirements of Contract Documents; to approve or accept any portion of work, or perform any duties of the contractor.
- D. Laboratory may not assume any duties of the Contractor; and the Laboratory has no authority to stop work.

#### 1.07 CONTRACTOR RESPONSIBILITIES

- A. Deliver to laboratory at designated location, adequate samples of materials proposed to be used which require testing, along with proposed mix designs.
- B. Cooperate with Laboratory personnel and provide access to work.
- C. Provide to Laboratory, preliminary representative samples of materials to be tested in required quantities.
- D. Furnish casual labor and facilities to provide access to work to be tested, to obtain and handle samples at the site, and to facilitate inspections and test.
- E. Notify Laboratory sufficiently in advance of operations to allow for his assignment of personnel and schedule of tests.
- F. Arrange with Laboratory, and pay for, any additional samples and testing required for Contractor's convenience.
- G. Arrange with Laboratory, and pay for, any additional inspections, sampling and testing required when initial tests indicate that work does not comply with Contract Documents.
- H. Arrange for and conduct any inspections required by State and/or local building, fire protection, safety, health or environmental officials.

#### PART 2 - PRODUCTS

Not Applicable

PART 3 - EXECUTION

Not Applicable

END OF SECTION

**SECTION 01 55 26**  
**MAINTENANCE AND PROTECTION OF TRAFFIC**

**PART 1 - GENERAL**

1.01 DESCRIPTION

A. WORK INCLUDED

The Contractor shall maintain traffic in the project area to the satisfaction of the applicable Local Regulatory Agencies, the Town of Windsor Locks, Connecticut Department of Transportation and the Engineer. Unless otherwise specified within the Contract Documents, the Contractor must maintain pedestrian and vehicular traffic and permit access to businesses, drives and intersecting streets. Where parking is prohibited, the Contractor shall post signs advising vehicles at least forty-eight (48) hours prior to commencing construction.

- B. It shall be the sole responsibility of the Contractor to keep the Local Regulatory Agencies (including but not limited to the Police and Fire Departments) pre-warned at least 48 hours in advance of changes in traffic patterns due to reduction of pavement widths or closing of streets. The Contractor shall supply, install, maintain, adjust, move, relocate, and store all signs, suitable lighted barricades, traffic cones, and traffic drums, as necessary to carry out the traffic routing plan and maintain vehicular and pedestrian traffic. All Work shall meet with the requirements of the Local Regulatory Agencies, Connecticut Department of Transportation and the Engineer.

1.02 RELATED WORK

- A. All of the Contract Documents apply to the work of this Section.  
B. Section 01 55 27 - Trafficmen (Special Duty Police)  
C. Section 01 57 20 - Dust Control

1.03 REFERENCES

- A. Where Form 817 is referred to, it means "State of Connecticut Department of Transportation Standard Specifications for Roads, Bridges and Incidental Construction, Form 817, 2016" and including all Supplemental Specifications to July 2018.  
B. "Manual of Uniform Traffic Control Devices, U.S. Department of Transportation, latest Edition.

1.04 QUALITY ASSURANCE

- A. Provide at least one person who shall be thoroughly trained and experienced in the

skills required, who shall be completely familiar with the design and application of work described for this Section, and who shall be present at all times during progress of the work of this Section and shall direct all work performed under this Section.

## **PART 2 - PRODUCTS**

### 2.01 MATERIALS

- A. Construction Signing shall conform to Article 12.20.02 of the Form 817.
- B. Traffic Cones shall conform to Article 9.77.02 of the Form 817.
- C. Traffic Drums shall conform to Article 9.78.02 of the Form 817.
- D. Barricade Warning Lights shall conform to Article 9.76.02 of the Form 817.
- E. Construction Barricades shall conform to Article 9.79.02 of the Form 817.

## **PART 3 - EXECUTION**

### 3.01 CONSTRUCTION METHODS

- A. Maintenance and Protection of Traffic shall be performed in accordance with Article 9.71.03 of the Form 817 as modified, and the Guidelines for "Traffic Control During Construction Operations". References to the Connecticut Department of Transportation shall be construed to mean the Owner or Engineer where applicable.
- B. Traffic Drums shall be placed in accordance with Article 9.78.03 of the Form 817.
- C. Construction Signing shall conform to Article 12.20.03 of the Form 817.
- D. Barricade Warning Lights shall conform to Article 9.76.03 of the Form 817.
- E. Trafficmen shall conform to Section 01 55 72 -Trafficmen (Special Duty Police).
- F. Traffic cones shall conform to Article 9.77 of the Form 817.
- G. Construction barricades shall conform to Article 9.79.03 of the Form 817.

### 3.02 PROJECT REQUIREMENTS

- A. The Contractor shall furnish, light, and maintain such signs as may be directed, or may be necessary for the safe regulation, or convenience of traffic. Said signs will be as specified on the contract plans or elsewhere herein, or if not specified, they shall be adequate for the

- regulation, safety and convenience of traffic. The Contractor shall provide, erect, and maintain suitably lighted barricades, warning lights, etc., as needed, or as directed in order to keep people, animals and vehicles from excavations, obstacles, etc. The Contractor may be required to employ trafficmen and take other such reasonable means or precautions as the Engineer may direct, or as may be needed to prevent damage or injury to persons, vehicles, or other property and to minimize the inconvenience and danger to the public by his construction operations. He shall arrange his operations to provide access to properties along the street including temporary bridges to driveways, and provide access to fire hydrants, manholes, gate boxes, or other utilities. Whenever any work obstructs traffic in or to any Public Street, private driveway, or property entrance, the Contractor shall take such steps as required to maintain necessary traffic and access including temporary bridging if required. The Contractor shall confine his occupancy of public or traveled ways to the smallest space compatible with the efficient and safe performance of the work contemplated by the contract.
- B. The Contractor shall observe and obey all local and state laws, ordinances, regulations and permits in relation to the obstruction of streets and highways, keeping passageways open and protecting traffic where there may be danger from construction activities.
  - C. Suitable lighted barriers or barricades shall be furnished by the Contractor and put up and maintained at all times during the night or day time, around all open ditches, trenches, excavations or other work potentially dangerous to traffic. Such barricades shall be as shown on the contract plans, or if not shown, will be constructed of 2 inch by 8 inch rough lumber, securely supported and braced at least 3 feet high above the ground. Barricades shall be placed on all sides and throughout the entire length and breadth of all open ditches, trenches, excavations, or other work which must be barred to the general public. Barricades shall be properly painted to the satisfaction of the Owner/Engineer in order to retain a high degree of visibility to vehicular and pedestrian traffic.
  - D. The use of unauthorized or unapproved signs, barricades, drums, traffic cones or delineators will not be permitted.
  - E. All signs in anyone signing pattern shall be mounted the same height above the roadway. The Contractor shall keep all signs in proper position, clean and legible at all times. Care shall be taken so that weeds, shrubbery, construction materials or equipment and soil are not allowed to obscure any sign, light, barricade or sightline. Signs that do not apply to existing conditions shall be removed or adjusted so that the legend is not visible to approaching traffic.
  - F. Should the Contractor or his employees neglect to set out and maintain barricades or lights, as required in these specifications, the Owner/Engineer immediately, and without notice, may furnish, install, and maintain barricades or lights. The cost thereof shall be borne by the Contractor and may be deducted from any amount due or to become due to the Contractor under this contract.

- G. The Contractor will be held responsible for any damages that the Local Public Agency, Town of East Hampton, Connecticut Department of Transportation, Engineer, Governmental Units, or their heirs or assigns may have to pay as a consequence of the Contractor's failure to protect the public from injury, and the same may be deducted from any payments that are due or may become due to the Contractor under this contract.
- H. If the Contractors' operations or occupancy of any public street or highway, or the uneven surfaces over any trenches being maintained by the Contractor shall interfere with the removal or sanding of snow or ice by the public authorities or adjoining landowners, in an ordinary manner with regular highway equipment, the Contractor shall be required to perform such services for the public authorities or adjoining owners without charge. If the Contractor fails to do so, he shall reimburse the said authorities or adjoining owners or the Local Public Agency for any additional cost to them for doing such work occasioned by conditions arising from the Contractors' operations, occupancy, or trench surfaces, together with any damage to the equipment of said parties by those conditions, or claims of any parties for damage or injury or loss by reason of failure to remove snow or ice or to sand icy spots under these conditions.

**END OF SECTION**



**SECTION 01 55 27  
TRAFFICMEN (SPECIAL DUTY POLICE)**

**PART 1 - GENERAL**

1.01 DESCRIPTION

- A. The work covered under this Section shall consist of providing services of uniformed trafficmen/traffic directors at such locations and for such periods as may be necessary for safety or as the applicable State of Connecticut or Local Regulatory Agencies and/or Engineer may order for the control and direction of vehicular traffic and pedestrians.

1.02 RELATED WORK

- A. All of the Contract Documents apply to the work of this Section.
- B. Section 01 55 26 - Maintenance and Protection of Traffic

1.03 QUALITY ASSURANCE

- A. Where Form 817 is referred to, it means "State of Connecticut Department of Transportation Standard Specifications for Roads, Bridges and Incidental Construction, Form 817, 2016" and including all Supplemental Specifications to July 2018.

1.04 SUBMITTALS

None

**PART 2 - PRODUCTS**

Not Applicable

**PART 3 – EXECUTION**

3.01 GENERAL

- A. The Work of this Section shall be executed as described and in accordance with Form 817, Article 9.70.01, except that the Town(s) requirements regarding the use of Special Duty Police shall govern.

**END OF SECTION**

**SECTION 01 57 00**  
**TEMPORARY CONTROLS**

**PART 1 - GENERAL**

1.01 DESCRIPTION

- A. Erosion and Sediment Control
- B. Pollution Control
  - 1. Air
  - 2. Water
  - 3. Soil
- C. Stormwater Control (Run-on and run-off)
- D. Maintenance Cleaning of Construction Site
- E. Traffic Control

1.02 RELATED WORK

- A. Section 01 55 26 - Maintenance and Protection of Traffic
- B. Section 01 57 13 - Sediment and Erosion Control
- C. Section 01 57 20 - Dust Control

1.03 QUALITY ASSURANCE

- A. All work to be performed in accordance with the requirements of the "Connecticut Guidelines for Soil Erosion and-Sedimentation Control" (2002).

**PART 2 - PRODUCTS**

2.01 GENERAL

- A. Not Applicable.

**PART 3 - EXECUTION**

3.01 EROSION AND SEDIMENT CONTROL

- A. Plan and execute construction by methods which will minimize and control surface drainage from fills and waste disposal so as to reduce erosion and sedimentation to least practicable amounts. To assist in accomplishing this objective, utilize the following measures (and others) as appropriate:
  - 1. Expose least possible amount of bare soil and/or waste at any one time.
  - 2. Construct temporary dikes, berms, and drainage channels as needed to control storm drainage.

3. Use judicious, selective placement of deposits when constructing fill, to avoid entrapment of ponds of rainwater and excessive erosion.
4. Make frequent inspections for erosion and sedimentation and take corrective actions as necessary.

### 3.02 POLLUTION CONTROL

#### A. Air Release Control

1. Instruct operators of earth-moving equipment (trucks, bulldozers, back-hoes, etc.) and their supervisors in the requirement for and the measures necessary to be taken for minimizing the generation (stirring-up) of dust clouds and release into the atmosphere of noxious fumes and organic vapors.
2. Provide, and utilize as needed, equipment and personnel for water to trap and settle dust and fumes.

#### B. Water Pollution Control

1. Grade project site to direct surface drainage away from excavations.
2. Provide pumping equipment and personnel, and operate so as to maintain excavations free of water on a 24-hour, 7-day basis.
3. Channel drainage such that it will pick up minimum pollution from soil.
4. Stormwater run-off from an open area must be retained. Minimize stormwater quantities by maintaining the open area of excavation as small as practical while simultaneously backfilling.

### 3.03 WATER CONTROL

- A. Construct temporary dikes, berms and drainage channels to prevent encroachment of storm flood water (run-on) and to prevent escape of accumulated stormwater (run-off) from going off site.
- B. Inspect temporary dikes, berms and drainage channels after heavy rains for damage assessment and repair as necessary.

### 3.04 MAINTENANCE CLEANING OF CONSTRUCTION SITE

- A. Provide and require the use of conveniently located covered containers for rubbish, debris, and non-hazardous waste, and frequently dispose of such material off site or per direction of the Engineer.
- B. Maintain appearance of site to be neat and orderly.
- C. No washing/cleaning of construction equipment or vehicles outside at the project site is allowed.

### 3.05 TRAFFIC CONTROL

- A. Restrict vehicular and pedestrian access to site.
- B. Monitor and restrict vehicular parking to construction personnel and other authorized persons, and maintain vehicular access.
- C. Prevent parking on or adjacent to access roads and other non-authorized areas on construction site.
- D. Schedule and stagger all trucks and material deliveries to minimize on-site and off-site congestion and accidents.

**END OF SECTION**

**SECTION 01 57 13**  
**SEDIMENT AND EROSION CONTROL**

**PART 1 - GENERAL**

1.01 DESCRIPTION

A. WORK INCLUDED

The work of this Section shall include, but not necessarily be limited to, the following:

1. The furnishing and installation of sedimentation control system, crushed stone dikes, grading to control runoff, baled hay/straw, mulch, outfall protection, temporary seeding and other erosion control devices.
2. Continual maintenance of installed erosion control devices.
3. Removal and cleanup.

1.02 RELATED WORK

1. All of the Contract Documents apply to the work of this Section.
2. Section 01 57 20 - Dust Control
3. Section 31 23 00 - Excavation and Site Work
4. Section 31 23 33 - Trench Excavation

1.03 QUALITY ASSURANCE

- A. Where Form 817 is referred to, it means "State of Connecticut Department of Transportation Standard Specifications for Roads, Bridges and Incidental Construction, Form 817, 2016" and including all Supplemental Specifications to July 2018.
- B. References to "Connecticut Guidelines for Soil Erosion and-Sedimentation Control" (2002).

1.04 SUBMITTALS

- A. Submit haybale, sediment control system, geotextile, inlet sediment control device, and seed mixture technical data to the Engineer for approval.
- B. Submit certified test results from a testing laboratory for riprap and crushed stone to the Engineer for approval. Test results must indicate characteristics of materials including gradations. The cost of all testing shall be borne by the Contractor.

## **PART 2 - PRODUCTS**

### 2.01 MATERIALS

- A. Haybales for Check Dams shall comply with the Form 817, Article 2.19.03.
- B. Sedimentation Control System shall comply with Form 817, Article M.08.01-19.
- C. Riprap for temporary sediment traps and outfall protection shall comply with Form 817, Article M.12.02.
- D. Geotextile for temporary sediment traps shall conform to the requirements of Form 817, Article M.08.01-19.
- E. Crushed stone shall conform to the requirements of Form 817, Article M1.01.01, No. 3.
- F. Temporary Seeding: seed for topsoil stockpiles and exposed areas of disturbance that may remain for extended periods and subject to erosion, shall meet the requirements of Form 817, Article M13.04 (b).
- G. Inlet Sediment Control shall be "Siltsack" high flow manufactured by ACF Environmental or approved equal.

## **PART 3 - EXECUTION**

### 3.01 GENERAL EROSION CONTROL REQUIREMENTS

- A. The Contractor shall appoint an individual, acceptable to the Owner and/or Engineer, to coordinate and supervise the maintenance and control of sedimentation and erosion control systems and devices. Compliance with these provisions shall also be included in all subcontract agreements.
  - 1. All sedimentation and erosion control devices shall be inspected weekly by the Contractor to verify their operation and to determine the cleaning and repair necessary for the duration of this Contract. In addition, special attention shall be given to the adequacy of the control systems prior to severe storm weather forecasts. Suspend operations (earthwork) for major storm events and implement additional sedimentation and erosion controls as necessary. Inspect control systems during and after storms to determine necessary repairs.
  - 2. Repairs to sedimentation control systems directed by the Owner/Engineer shall be accomplished within 24 hours of the directive or as soon as possible prior to storm forecasts.
  - 3. Contractor shall maintain on-site, at all times, replacement materials for the devices utilized, readily available for necessary repairs.

4. The Contractor shall comply with the Best Management Practices as shown in Form 817, Article 1.10.03 and "Connecticut Guidelines for Soil Erosion and-Sedimentation Control" (2002).
  - A. The Owner/Engineer has the authority to control the surface area of each material exposed by construction operations and to direct the Contractor to immediately provide permanent or temporary pollution control measures to prevent contamination of adjacent wetlands, watercourses or other areas of water impoundment. Every effort shall be made by the Contractor to prevent erosion on the site and abutting property.
  - B. The Owner/Engineer shall limit the surface area of earth material exposed if the Contractor fails to sufficiently protect the slopes to prevent pollution.
  - C. The erosion control features installed by the Contractor shall be maintained by the Contractor to ensure their efficient operation, and he shall remove/replace such installations if ordered by the Owner/Engineer.
  - D. The Contractor shall operate all equipment and perform all construction operations so as to minimize pollution. The Contractor shall cease any of his operations, which will increase pollution during rainstorms.

### 3.02 HAYBALE/STRAW BALE INSTALLATION

- A. Bales shall be placed around catch basins, along diversion fences, in swales, or as directed by the Engineer. They shall be held in place by two wooden stakes in each bale driven a minimum of eighteen (18) inches into the ground. Bales shall be maintained or replaced until they are no longer necessary for the purpose intended or are ordered removed by the Owner/Engineer.

### 3.03 SEDIMENTATION CONTROL SYSTEM

- A. Sedimentation Control System shall be mounted on wood-stakes or posts with or without fence backing as recommended by the fabric manufacturer. The bottom six (6") inches of the fabric shall be buried by trenching, laying the six (6") inch section horizontally on the ground and burying by ramping the soil up to the control fence.
- B. Maintain sedimentation control system throughout the contract period and remove all such temporary features when directed. Any damaged during construction shall be replaced at no additional cost to the Owner.
- C. Sediment buildup shall be removed from behind fences before it exceeds six (6") inches in depth. Sedimentation control system shall be inspected weekly and repaired/replaced as necessary. Additional inspections may be required prior to or immediately following any major rainstorms. Sedimentation control systems shall be removed at the completion of the project.

### 3.04 CRUSHED STONE DIKES

- A. Install crushed stone dikes in permanent ditches where called for on plan or where as directed by the Owner/Engineer.

### 3.05 TEMPORARY SEEDING

- A. Temporary seed shall be spread using broadcast or mechanical means.

### 3.06 TEMPORARY SEDIMENT TRAP

- A. Temporary sediment traps shall be constructed where shown on the plans or as directed by the Owner/Engineer. Traps shall be constructed as shown on the Contract Drawings and as required by the "Connecticut Guidelines for Soil Erosion and-Sedimentation Control" (2002).

### 3.07 INLET SEDIMENTATION CONTROL DEVICE

- A. Inlet sedimentation control devices shall be installed at each catch basin grate inlet. Appropriate models shall be selected depending on the type and size catch basin to be protected. Install and maintain in accordance with manufacturer's recommendations and requirements.

### 3.08 REMOVAL AND CLEANUP

- A. All temporary erosion control facilities when ordered by the Engineer shall be removed in a neat and workmanlike manner, and shall also include removal and disposal of accumulated silt.
- B. Sediment deposits are to be removed when they reach approximately one-half the height of the device, i.e. sedimentation control fence, haybales, etc. Accumulations of one-half of the wet storage volume in any temporary sediment trap will be used as criteria for commencement of cleaning operation. Disposal of materials removed during cleaning operations shall be the responsibility of the Contractor. Dispose material off-site or as directed by the Owner and/or Engineer.

**END OF SECTION**



**SECTION 01 57 20  
DUST CONTROL**

**PART 1 - GENERAL**

1.01 DESCRIPTION

- A. Furnish and spread materials to control dust throughout the project area as directed by the Owner and/or Engineer.
- B. The furnishing of a pickup sweeper and utilizing it to remove earth and/or dust producing materials from pavement for the purpose of allaying dust conditions.

1.02 RELATED WORK

- A. Section 01 57 00 - Temporary Controls
- B. Section 31 23 00 - Excavation and Site Work
- C. Section 31 23 33 - Trench Excavation

1.03 QUALITY ASSURANCE

- A. Where Form 817 is referred to, it means "State of Connecticut Department of Transportation Standard Specifications for Roads, Bridges and Incidental Construction, Form 817, 2016" and including all Supplemental Specifications to July 2018.

**PART 2 - PRODUCTS**

2.01 CALCIUM CHLORIDE

- A. Calcium chloride will not be allowed on this project.

2.01 WATER FOR DUST CONTROL

- B. Water for dust control shall be potable.

**PART 3 - EXECUTION**

3.01 CONSTRUCTION METHODS

- A. All of the Contractor's work which may contribute to dusty conditions plus any of the Contractor's work which involves vehicular movement over unpaved surfaces shall be monitored and remedied under the requirements of this Section.
- B. Construction methods for this work are as described in Form 817, Article 9.43.03 for "Water for Dust Control".

- C. Sweeping shall be in conformance with Form 817, Article 9.39.03. In areas where the pickup sweeper cannot be used efficiently, sweeping shall be done by hand or other acceptable means. Water trucks shall be capable of applying a uniform spread of water over the surface.

**END OF SECTION**

**SECTION 02 08 00  
ASBESTOS ABATEMENT**

**PART 1 - GENERAL**

1.1 RELATED DOCUMENTS

- A. Drawings and general provisions of the Contract, including General and Supplementary Conditions and other Division 01 Specification Sections, apply to this Section.
- B. Related Sections:
  - 1. Section 01 01 00 – Hazardous Abatement General Conditions
  - 2. Section 31 23 33 – Trench Excavation

1.2 GENERAL PROVISIONS

- A. Select areas of sewer piping located under roadways on Juniper Drive in the Town of Windsor Locks, Connecticut, will be undergoing excavation, removal and replacement.
- B. The sewer piping scheduled to be replaced has been determined to contain asbestos. The work covered in this section includes the minimum procedures that shall be employed during the abatement of the asbestos-containing piping.
- C. Refer to other Sections of these Specifications to determine the type and extent of work therein affecting the work of this Section, whether or not such work is specifically mentioned herein.
- D. Chris Liberti of Eagle Environmental, Inc. is the designer of this Specification. Mr. Liberti is a State of Connecticut Department of Public Health (CTDPH) Licensed Asbestos Project Designer (License #000261).

1.3 PROJECT DESCRIPTION

- A. The work to be performed includes but is not limited to the proper removal, handling, and disposal of all asbestos-containing sewer piping located under roadways in Windsor Locks, Connecticut.
- B. Base Bid asbestos abatement work shall include but not be limited to the ACM identified in the following Table 1- Base Bid. It is the sole responsibility of the Asbestos Abatement Contractor (AAC) to visit the site, review the Contract Documents and determine the quantities of ACM to be removed when developing their bid. Location, estimated quantities, and abatement phasing plan of specific items noted in paragraph A above include:

**TABLE I – BASE BID**

MATERIAL	LOCATION(S)	ESTIMATED QUANTITY
8” Diameter Sewer Pipe	Exterior: Under asphalt paving*	104 LF

\*The contractor shall remove overlying asphalt and soils to access the pipe. Contaminated soil with broken pipe debris, if identified once pipe excavated, shall be disposed of as asbestos waste.

- C. The AAC shall coordinate the work of the Asbestos Abatement Section with that of the work of the Engineer, the Owner and the local police department. It is the AAC's responsibility to become familiar with the project's construction phasing plan and to include, if any, remobilization fees to support the phasing. It is anticipated that the abatement work of this project will be completed within the overall project schedule.
- D. The intent of the project schedule is to remove all non-friable asbestos-containing sewer piping from limited areas under roadways on Juniper Street. Work under this project may be performed in phases to accommodate Owner's requirements and construction phases. Coordinate abatement schedule and operations with the Owner, Owner's Consultant and other trades.
- E. The AAC shall determine the quantities of asbestos-containing materials requiring removal prior to submission of bid. Any discrepancies must be submitted in writing in RFI format to the Engineer for interpretation prior to submission of bid.
- F. The AAC shall be required to remove all overlying asphalt and soils to access pipe below grade within specified areas. Coordinate locating pipe, permits and road closures with Owner.
- G. The sewer piping is anticipated to be intact. If pipe is broken, pipe debris and associated soils shall be removed and disposed of as ACM.
- H. Piping shall be removed as an exterior non-friable asbestos abatement project. Piping shall not be mechanically crushed or saw cut rendering the material friable. If pipe must be broken to remove, breaks shall be made utilizing a compression-type cutter to split pipe in desired location.
- I. If the AAC anticipates making the cement piping friable (by saw cutting or crushing the pipe), the CTDPH Standards for Asbestos Abatement Sections 19a-332a-1 through 19a-332a-16 will apply.
- J. The AAC is directed to review the overall project schedule to assist them in developing their bid.

#### 1.4 QUALITY ASSURANCE

- A. The AAC shall be licensed by the State of Connecticut Department of Public Health (DPH) to perform asbestos abatement.
- B. The Asbestos Abatement Supervisor(s) and Asbestos Abatement Workers shall be accredited in accordance with EPA regulation 40 CFR Part 763, subpart E, Appendix C; and shall be licensed by the State of Connecticut Department of Public Health.

#### 1.5 APPLICABLE CODES

- A. The AAC shall be solely responsible for conducting this project and supervising all work in a manner that will be in conformance with all federal, state and local regulations and guidelines pertaining to asbestos abatement. Specifically, the AAC shall comply with the requirements of the following:
  - 1. USEPA NESHAP Regulations (40 CFR 61, Subpart M);
  - 2. OSHA Asbestos Regulations (29 CFR 1910.1001 and 1926.1101);
  - 3. Connecticut DEEP Regulations (Section 22a-209-8 (I) and Section 22a-220 of the Connecticut General Statutes);

4. Connecticut DPH Standards for Asbestos Abatement Sections 19a-332a-1 to 19a-332a-16;
5. Connecticut DPH Licensure and Training Requirements Section 20-440-1 to Section 20-440-9.
6. Connecticut Basic Building Code (BOCA);
7. Connecticut Fire Safety Code (NFPA);
8. Local health and safety codes, ordinances or regulations pertaining to asbestos remediation and all national codes and standards including ASTM, ANSI, and Underwriter's Laboratories.

#### 1.6 EXEMPTIONS

- A. This project was designed by a State of Connecticut Department of Public Health licensed Asbestos Abatement Designer. Any deviation from these specifications requires the written approval and authorization from the Designer.
- B. Any deviations from CTDPH Standards for Asbestos Abatement Sections 19a-332a-1 through 19a-332a-16 must be requested in writing and must be approved in writing by CTDPH if this Standard will apply to this project.

#### 1.7 NOTIFICATIONS, POSTINGS AND PERMITS

- A. The removal of the sewer piping is anticipated to be performed as a non-friable exterior abatement project which is not notifiable to the CTDPH.
- B. If the AAC anticipates making the cement piping friable (by saw cutting or crushing the pipe), the CTDPH Standards for Asbestos Abatement Sections 19a-332a-1 through 19a-332a-16 will apply and the AAC shall make the following notifications and provide the submittals to the following agencies prior to the commencement of removal work. This notification is required ten (10) calendar days prior to the start of the abatement project:
  1. State of Connecticut  
Department of Public Health  
Indoor Air Program, MS #12 AIR  
410 Capitol Avenue  
P.O. Box 340308  
Hartford, CT 06134-0308
- C. For friable abatement, the minimum information included in the notification is as follows:
  1. Name and address of building owner/operator
  2. Building location
  3. Building size, age, and use
  4. Amount of friable asbestos
  5. Work schedule, including proposed start and completion date
  6. Asbestos removal procedures to be used
  7. Name and location of disposal site for generated asbestos waste, residue, and debris
- D. Ten day notifications shall be posted for each individual phase of the project.

#### 1.8 WORK SITE SAFETY PLAN

- A. The AAC shall establish a set of emergency procedures and shall post them in a conspicuous

place at the work site. The safety plan should include provisions for the following:

1. Evacuation of injured workers.
2. Emergency exit routes from all work areas.
3. Emergency first aid treatment.
4. Local telephone numbers for emergency services including ambulance, fire, and police.
5. A method to notify workers in the event of a fire or other emergency requiring evacuation of the building.
6. Confined space entry program.
7. 24 hour site security program.
8. Trenching protocol's.

B. The AAC is responsible for training all workers in these procedures.

#### 1.9 ALTERNATIVE WORK PRACTICES (AWP)

A. No AWP's have been issued for this project.

B. Any deviations from these specifications require the written approval and authorization from the Owner and Owner's Consultant.

C. Any deviations from the CTDPH Standards for Asbestos Abatement Sections 19a-332a-1 through 19a-332a-16 must be requested in writing and must be approved in writing by CTDPH.

#### 1.10 RE-OCCUPANCY CLEARANCE

A. The intent of the project is for the piping to be removed as an exterior non-friable abatement project so that re-occupancy air sampling will not be required.

B. If the AAC will render the piping friable, full containment procedures and re-occupancy air monitoring will be required if greater than three (3) linear or square feet of asbestos is disturbed following the requirements of the CTDPH Standards for Asbestos Abatement Sections 19a-332a-1 through 19a-332a-16. The AAC shall be responsible for payment of all costs associated with the collection and analysis of final air clearance samples for friable abatement work areas.

C. Phase Contrast Microscopy (PCM) air samples will be analyzed by an Eagle Environmental hygienist on a six-four (6) hour turn-around time.

#### 1.11 CONTROL OVER REMOVAL WORK

A. All AAC work procedures shall be monitored by the AAC's "Competent Person" to ensure that areas outside the designated work locations do not become contaminated. The following controls shall be implemented each working day to help ensure this:

1. Prior to work on any given day, the AAC's designated "Competent Person" shall evaluate job tasks with respect to safety procedures and requirements specified to prevent contamination of the building or the employees. This includes a visual survey of the work area and the decontamination enclosure systems.

B. The AAC shall maintain control of and be responsible for access to all work areas to ensure the following requirements:

1. Nonessential personnel are prohibited from entering the area;

2. All authorized personnel entering the work area shall sign the work area entry log;
3. All authorized personnel entering the work area shall read the "worker protection procedures" which are posted at the entry points to the enclosure system, and shall be equipped with properly fitted respirators and protective clothing;
4. All personnel who are exiting from the decontamination enclosure system shall be properly decontaminated;
5. Asbestos waste that is taken out of the work area must be properly bagged and labeled in accordance with these specifications. The surface of the bags shall be decontaminated. Asbestos waste leaving the work area must be transported off site or immediately placed in locked, posted temporary storage on Site, and be removed within 24 hours of the project conclusion;
6. Any material, equipment, or supplies that are brought out of the work area shall be cleaned and decontaminated by wet cleaning and/or HEPA vacuuming of all surfaces.

#### 1.12 SITE SECURITY

- A. The AAC shall be responsible for the security of regulated areas. Post asbestos abatement warning signs at entrances to the work area including the waste load out and worker decontamination chamber. The AAC shall have a supervisor monitoring the entrance of the worker decontamination chamber during abatement work.
- B. The supervisor shall maintain a work area access log for each work area. The access log shall document each person that enters the work area, the time entered and the time exited. Copies of the work area access logs shall be provided to the Owner's Consultant during the course of the project.

#### 1.13 PERSONNEL PROTECTION

- A. Prior to commencing work, instruct all workers in all aspects of personnel protection, work procedures, emergency procedures use of equipment including procedures unique to this project.
- B. Respiratory protection shall meet the requirements of OSHA as required in 29 CFR 1910.134, 29 CFR 1926.11, 29 CFR 1926.62 and the requirements of the CTDPH Standards for Asbestos Abatement (19a-332a-1 through 16) A formal respiratory protection program must be implemented in accordance with 29 CFR 1926.1101 and 29 CFR 1910.134. The AAC shall conduct exposure assessment air sampling, analysis and reporting to ensure the workers are using appropriate respiratory protection.
- C. The AAC shall provide appropriate respiratory protection for each worker and ensure usage during potential asbestos exposure.
- D. The AAC shall provide respirators from among those approved as being acceptable for protection by the National Institute for Occupational Safety and Health (NIOSH) under the provisions of 30 CFR Part II.
- E. The AAC shall provide an adequate supply of filters for respirators in use.
- F. Minimum respiratory protection shall be as follows:

Air borne Asbestos Level:

Not in excess of 1 f/cc (10 x PEL)

Not in excess of 5 f/cc (50 x PEL)

Not in excess of 10 f/cc (100 x PEL)

Not in excess of 100 f/cc (1000 x PEL)

Greater than 100 f/cc (1000 x PEL)

Required Respirator:

Half mask air purifying or otherwise as required respirator other than a disposable respirator, equipped with HEPA P 100 filters.

Full face piece air purifying respirator equipped with HEPA P 100 filters.

Any powered air purifying respirator equipped with HEPA P 100 filters or any supplied air respirator operated in continuous flow mode.

Full face piece supplied air respirator operated in pressure demand mode.

Full face piece supplied air respirator unknown operated in pressure demand mode, equipped with an auxiliary positive pressure self-contained breathing apparatus.

Notes:

1. Respirators assigned for higher airborne fiber concentrations may be used at lower concentrations.
  2. A high efficiency filter means a filter that is at least 99.97 percent efficient against mono-dispersed particles of 0.3 micrometers in diameter or larger.
  3. In addition to the selection criteria in paragraph 1.13F, the AAC shall provide a tight-fitting powered air purifying respirator equipped with high efficiency filters or a full face piece supplied air respirator operated in the pressure demand mode equipped with HEPA egress cartridges or an auxiliary positive pressure self-contained breathing apparatus for all employees within the regulated area where Class I work is being performed for which a negative exposure assessment has not been produced and the exposure assessment indicates the exposure level will not exceed 1 f/cc as an 8-hour time weighted average. A full face piece supplied air respirator operated in the pressure demand mode equipped with an auxiliary positive pressure self-contained breathing apparatus shall be provided under such conditions if the exposure assessment indicates exposure levels above 1 f/cc as an 8 hour time weighted average.
  4. If compressed air is used for supplied air respirators, this air will meet the requirements for grade D breathing air as described by the Compresses Gas association commodity Specification G-7.1-1966. The compressor will be equipped with the necessary safety devices and sorbends/filters, and be situated to avoid entry of contaminated air. In addition, the compressor will be equipped with alarms to indicate failure or overheating, and additional alarms for indicating the presence of carbon monoxide. Air line couplings will be incompatible with outlets for other gas system to prevent inadvertent servicing of air line respirators with non-respirable gases.
- G. The AAC shall provide and require all workers to wear protective clothing in Work Areas where asbestos fiber concentration exceeds permissible limits established by the OSHA or where contamination exists. Protective clothing shall include impervious coveralls with elastic wrists and ankles, head covering, gloves and foot coverings.
- H. The AAC shall ensure that all authorized persons entering contaminated areas are equipped with proper respirators and protective clothing.



#### 1.14 WORKER PROTECTION PROCEDURES

- A. The AAC shall monitor airborne asbestos concentrations in the workers' breathing zone to establish conditions and work procedures for maintaining compliance with OSHA Regulations 29 CFR 1910.1001 and 1926.1001.
- B. The AAC's air sampling professional shall document all air sampling results and provide all air sampling reports as soon as feasible. OSHA air monitoring results shall be posted at a conspicuous location at the job site.
- C. All personnel air sampling shall be conducted in accordance with methods described in OSHA standards 29 CFR 1910.1001 and 1926.1101.

#### 1.15 SUBMITTALS

- A. The AAC will submit two (2) copies of the following submittals to the Owner's Representative ten (10) calendar days prior to the commencement of removal work:
  - 1. AAC's construction schedule
  - 2. Shop drawings showing work area configuration with remote decontamination facility and waste container locations
  - 3. Waste generator label to be used
  - 4. Waste shipment and disposal form to be used with generated information
  - 5. Waste hauling contractor
  - 6. Asbestos abatement training (initial and latest refresher), licenses and medical records of each employee who may be on the project site
  - 7. The qualifications of the hygiene firm that the AAC proposes to use for this project to analyze AAC employee OSHA monitoring samples
  - 8. Copies of all notifications and permits
  - 9. Copies of the written respirator plan compliant with the most current issue of OSHA 1910.134
  - 10. Copies of all SDS sheets for materials to be used on Site
  - 11. Work Site Safety Plan
  - 12. Negative Exposure Assessment or confirmation that OSHA personal air sampling to be performed during project
  - 13. AAC's State of Connecticut Asbestos Contractor license
  - 14. State Notification (if friable abatement performed)
- B. The AAC will submit the following to the Consultant during the work:
  - 1. Results of all personal air sampling
  - 2. Certificate, training, medical, and fit-test records for new employees to start work (24 hours in advance of work).
  - 3. AAC site logs and containment access logs
  - 4. Revised Notification, if any.
  - 5. Waste logs for all asbestos waste being transported from the Site.
- C. The following shall be submitted to the Consultant at the completion of work:
  - 1. Completed copies of Waste Shipment Records (WSR).
  - 2. Remaining personal air sampling results and site logs.

## 1.16 DEFINITIONS

- A. **ABATEMENT** - Procedures to control fiber release from asbestos-containing materials; includes removal, encapsulation, and enclosure.
- B. **AIRLOCK** - A system for permitting ingress and egress while assuring air movement to a contaminated area from an uncontaminated area. Two curtained doorways spaced a minimum of six feet apart can form an airlock.
- C. **AIR MONITORING** - The process of measuring the fiber concentration of an area or of a person.
- D. **AIR SAMPLING PROFESSIONAL** – A licensed professional capable of developing air sampling protocols and conducting air monitoring and analysis. This individual should be an industrial hygienist, an environmental scientist, or an engineer with experience in asbestos air monitoring and worker protection equipment and procedures. This individual should have demonstrated proficiency in conducting air sample collection in accordance with 29 CFR 1910.1001 and 1926.1101.
- E. **ADEQUATELY WETTED** - means sufficiently mixed or coated with water, amended or an aqueous solution; or the use of removal encapsulant to prevent dust emissions.
- F. **AMENDED WATER** - Water to which a surfactant has been added.
- G. **ASBESTOS** - The name given to a number of naturally occurring fibrous silicates. This includes the serpentine forms and the amphiboles and includes chrysotile, amosite, crocidolite, tremolite, anthophyllite, and actinolite, or any of these forms that have been chemically altered.
- H. **ASBESTOS ABATEMENT** - Means the removal, encapsulation, enclosure, renovation, or repair of asbestos-containing materials except activities that are related to the removal or repair of asbestos cement pipe and are performed by employees of a water company as defined in Section 25-32a of the Connecticut General Statutes.
- I. **ASBESTOS ABATEMENT SITE SUPERVISOR** - Means any licensed individual who is employed or engaged by an AAC to supervise an asbestos abatement project.
- J. **ASBESTOS ABATEMENT WORKER** - Means any employee of an AAC who engages in asbestos abatement.
- K. **ASBESTOS CONSULTANT** - Any person who engages in any activity directly involved with asbestos consultation services and who has been issued a certificate by the commissioner and a license by the department.
- L. **ASBESTOS CONTAINING MATERIAL (ACM)** - A material composed of asbestos of any type and in an amount greater than one percent by weight, either alone or mixed with other fibrous or nonfibrous material.
- M. **ASBESTOS CONTRACTOR** - Any person or entity engaged in asbestos abatement whose employees actually perform asbestos abatement work.
- N. **ASBESTOS CONTROL AREA** - An area where asbestos abatement operations are performed which is isolated by physical boundaries to prevent the spread of asbestos dust, fibers, or debris.

- O. ASBESTOS FIBERS - Those particles with a length greater than five (5) microns and a length to diameter ratio of 3: 1 or greater.
- P. ASBESTOS PERMISSIBLE EXPOSURE LIMIT (PEL) - The maximum airborne concentration of asbestos fibers to which an employee is allowed to be exposed. The current level established by OSHA is 0.1 fibers per cubic centimeter of air as an eight (8) hour time weighted average and 1.0 fibers/cc averaged over a sampling period of 30 minutes as an excursion limit. The AAC is responsible for maintaining work areas in a manner that this standard is not exceeded.
- Q. ASBESTOS PROJECT MONITOR - The licensed asbestos consultant who is certified as a project monitor and who functions as an on-site representative of the facility Owner or other persons by over-seeing the activities of the asbestos abatement contractor.
- R. AUTHORIZED VISITOR - Any person authorized by the Owner to enter the building.
- S. BUILDING OWNER - For this Contract only, the building Owner is the Town of Windsor Locks.
- T. CLEAN ROOM - An uncontaminated area or room, which is a part of the workers' decontamination enclosure with provisions for storage of workers' street clothes and protective equipment.
- U. CLEARANCE SAMPLING - Final air sampling performed aggressively after the completion of the abatement project in a regulated area. Five (5) air samples collected by the asbestos abatement project monitor inside the work area, and having a fiber concentration of less than 0.010 fibers/cc of air will denote acceptable clearance sampling by Phase Contrast Microscopy. Five air samples collected by the asbestos abatement project monitor having an average asbestos concentration of less than 70 asbestos structures mm/sq. will denote acceptable clearance sampling for Transmission Electron Microscopy.
- V. COMMISSIONER - Means the Commissioner of the Connecticut Department of Health Services or his/her authorized agent.
- W. COMPETENT PERSON - A representative of the AAC who is capable of identifying an asbestos hazard and who has the authority to take prompt corrective measures to eliminate the hazard during asbestos removal.
- X. CONFINED SPACE - A work zone where access and egress are restricted, a potential for gaseous vapors to accumulate exist, or a potential for low oxygen content exists.
- Y. DECONTAMINATION ENCLOSURE SYSTEM - A series of connected areas, with curtained doorways between any two adjacent areas, for the decontamination of workers and equipment. A decontamination enclosure system always contains at least one airlock and is adjacent and connected to the regulated area, where possible.
- Z. DEPARTMENT - The Department of Public Health.
- AA. EPA - Means the U.S. Environmental Protection Agency.
- BB. ENCAPSULANT - A liquid material that can be applied to asbestos-containing material that

controls the possible release of asbestos fibers from the materials by either creating a membrane over the surface (bridging encapsulant) or penetrating the material and binding its components together (penetrating encapsulant).

- CC. ENCAPSULATION - A specified asbestos remediation strategy involving the application of an encapsulant to asbestos containing materials to control the release of asbestos fibers into the air.
- DD. EQUIPMENT DECONTAMINATION ENCLOSURE - That portion of a decontamination enclosure system designed for controlling the transfer of materials and equipment, typically consisting of a washroom and a holding area.
- EE. EQUIPMENT ROOM - A contaminated area or a room, which is part of the workers' decontamination enclosure with, provisions for storage of contaminated clothing and equipment.
- FF. FACILITY - Means any private or public building or structure including but not limited to those used for institutional, residential (including single family homes), commercial or industrial purposes and vessels while ashore or in dry-dock.
- GG. FIXED OBJECT - A unit of equipment or furniture in the work areas which cannot be removed from the work area.
- HH. FRIABLE ASBESTOS MATERIAL - Any material that contains more than 1% asbestos by weight, that can be crumbled, pulverized or reduced to powder by hand pressure.
- II. GLOVE BAG - An impervious plastic bag-like enclosure affixed around asbestos containing material, with glove-like appendages through which materials and tools may be handled.
- JJ. HAZARDOUS MATERIALS ABATEMENT CONTRACTOR (AAC) - Means the Asbestos Contractor, Lead Based Paint Abatement Contractor and or PCB/DEHP and Mercury Vapor Lighting Removal Contractor.
- KK. HEPA FILTER - A high efficiency particulate air (HEPA) filter in compliance with ANSI Z9.2-1979.
- LL. HEPA VACUUM EQUIPMENT - Vacuum equipment with a HEPA filter system for filtering the effluent air from the unit.
- MM. HOLDING AREA - An air-locked chamber in the equipment decontamination enclosure located between the washroom and an uncontaminated area.
- NN. INSPECTOR (ASBESTOS ABATEMENT PROJECT MONITOR)- An individual, retained by the Building Owner, who is a "qualified asbestos abatement project monitor" as defined by the State of Connecticut Department of Public Health, and who will be responsible for monitoring the AAC during the asbestos abatement project.
- OO. MOVABLE OBJECT - A unit of equipment or furniture in the work area, which can be removed from the work area.
- PP. NEGATIVE AIR FILTRATION EQUIPMENT - A portable local exhaust system equipped

with HEPA filtration used to create negative pressure in a regulated area (negative with respect to adjacent unregulated areas) and capable of maintaining a constant, low velocity air flow into regulated areas from adjacent unregulated areas.

- QQ. OWNER'S REPRESENTATIVE -The Asbestos Consultant for the project.
- RR. NESHAPS - National Emissions Standard for Hazardous Air Pollutants regulations enforced by the EPA.
- SS. PLASTICIZE - To cover floors and walls with plastic sheeting as specified herein.
- TT. SEPARATION BARRIER - A rigid barrier sealed with two (2) layers of six (6) mil polyethylene sheeting installed between an occupied area and the asbestos abatement work area.
- UU. SHOWER ROOM - A room between the clean room and the equipment room in the workers' decontamination enclosure with hot/cold running water and suitably arranged for employee showering during decontamination. The shower room is located in an airlock between the contaminated area and the clean area.
- VV. STRIPPING - Removing asbestos materials from any structural member, pipe surface, HVAC, or other equipment.
- WW. WASHROOM - A room between the work area and the holding area in the equipment decontamination enclosure with provisions for storage of contaminated clothing and equipment.
- XX. WET CLEANING - The process of reducing asbestos contamination from building surfaces and objects by using cloths, mops, or other cleaning tools, which have been dampened by amended water, and by then disposing of these cleaning items as asbestos contaminated waste.
- YY. WORK AREA - Designated rooms, spaces, or areas of the project in which asbestos abatement actions are occurring and which may become contaminated as a result of such abatement actions. The work area must be totally self-contained by sealing, plasticizing and equipping the area with a decontamination enclosure system.
- ZZ. WORKER DECONTAMINATION ENCLOSURE SYSTEM - That portion of a decontamination enclosure system designated for controlled passage of workers, other personnel, and authorized visitors, typically consisting of a clean room, a shower room, and an equipment room.
- AAA. WORK STOPPAGE CLEANUP PROCEDURE - A process following the issuance of a written stop work order, whereby the AAC thoroughly cleans and decontaminates the work area, the decontamination enclosure system, and any other areas of the building affected by the removal project, to the satisfaction of the Asbestos Project Monitor.
- BBB. WORK ZONE - The area of the decontamination enclosure system where asbestos is being removed.

#### 1.17 PRECONSTRUCTION MEETING

- A. The AAC shall be required to attend a preconstruction meeting with his/her site supervisor, project manager and any subcontractor they employ on Site for the purpose of reviewing the contract requirements.

**PART 2 - MATERIALS AND EQUIPMENT**

2.1 MATERIALS

- A. Deliver all materials in the original packages, containers, or bundles bearing the name of the manufacturer and the brand name and product technical description.
- B. Damaged or deteriorating materials shall not be used and shall be removed from the premises. Material that becomes contaminated with asbestos shall be decontaminated or disposed of as asbestos waste.
- C. Polyethylene sheet in a roll size to minimize the frequency of joints shall be delivered to job site with factory label indicating 4 or 6 mil.
- D. Polyethylene disposable bags shall be true six (6) mil with preprinted labels.
- E. Tape shall be capable of sealing joints in adjacent polyethylene sheets and for attachment of polyethylene sheets to finished or unfinished surfaces of dissimilar materials and capable of adhering under both dry and wet conditions, including use of amended water.
- F. Surfactant (wetting agent) - shall consist of fifty (50) percent polyoxyethylene ether and fifty (50) percent polyoxyethylene ester, or equivalent, and shall be mixed with water to provide a concentration of one (1) ounce surfactant to five (5) gallons of water or as directed by manufacturer.
- G. Impermeable containers are to be used to receive and retain any asbestos-containing or contaminated materials until disposal at an acceptable disposal site. (The containers shall be labeled in accordance with OSHA Standard 29 CFR 1926-1101.) Containers must be both air and watertight.
- H. Labels and signs, as required by OSHA Standard 29 CFR 1926.1001 will be used.
- I. Encapsulant shall be bridging or penetrating type which has been found acceptable to Eagle Environmental. Usage shall be in accordance with manufacturer's printed technical data.
- J. Disposal labels shall be preprinted on self-adhesive labels with the generator name, abatement site and AAC's name and address. Labels shall not be photocopied and applied with spray adhesive.

2.2 TOOLS AND EQUIPMENT

- A. Provide suitable tools for asbestos removal, encapsulation and enclosure.
- B. The AAC shall have air monitoring equipment of type and quantity to monitor operations and conduct personnel exposure surveillance per OSHA requirements.
- C. The AAC shall have available sufficient inventory on site for materials necessary for the job including protective clothing, respirators, filter cartridges, polyethylene sheeting of proper size and thickness, tape, and air filters.
- D. The AAC shall provide temporary electrical power sources such as generators (when required).

- E. The AAC shall have available shower stalls and sufficient hose length and a drain system equipped with 5-micron filters.
- F. Exhaust air filtration system units shall contain HEPA filter(s) capable of sufficient air exhaust to create negative pressure of 0.02 inches of water within each enclosure (where friable abatement being performed) with respect to the outside area. Equipment shall be checked for proper operation by smoke tubes or a differential pressure gauge before the start of each shift and at least twice during the shift. Adequate exhaust air shall be provided for a minimum of four (4) air changes per hour within the enclosure. No air movement system or air filtering equipment shall discharge unfiltered air outside.
- G. When friable abatement being performed, the AAC will have reserve exhaust air filtration system units in order to maintain negative air filtration in the event that a unit malfunctions during use.
- H. When friable abatement being performed, the AAC shall have available and use recording manometers to monitor pressure differential between the work area and occupied areas of the building. A minimum negative pressure differential of 0.02 inches of water column shall be maintained.
- I. Vacuum units, of suitable size and capacities for project, shall have HEPA filter(s) capable of trapping and retaining at least 99.97 percent of all monodispersed particles of 0.3 micrometers in diameter or larger.
- J. The AAC shall have available spray equipment capable of mixing a wetting agent with water and capable of generating sufficient pressure and volume and having sufficient hose length to reach all areas with asbestos.

### **PART 3 - EXECUTION**

#### 3.1 REMOTE PERSONNEL DECONTAMINATION SYSTEM

- A. The AAC shall establish a remote personnel decontamination system during non-friable and friable abatement work procedures. The use of such remote decontamination unit must be indicated in the State Notification Form (for friable abatement). Access between the contaminated and uncontaminated areas shall be through this decontamination enclosure only. The decontamination system shall be constructed of two layers of six-mil polyethylene sheeting. Pre-fabricated "pop-up" decontamination chambers will be permitted on this project.
- B. Access between rooms in decontamination system shall be through double flap-curtained openings. Clean room, shower room and equipment room within decontamination system shall be completely sealed ensuring that the sole source of air flow through this area originates from uncontaminated areas outside the work area.
- C. The shower unit shall be equipped with an adequate supply of warm water. A shower filtration pump containing two (2) 5-micron sock filters or the best available technology shall be installed to filter shower water. Filtered shower water shall be discharged into sanitation drains and shall not be discharged into storm drains or onto floor or ground surfaces.
- D. The shower room shall have soap and an adequate supply of drying towels. Provide an adequate number of shower units in accordance with OSHA 29 CFR 1926.1101.

3.2 EXTERIOR WORK AREA PREPARATION – NON-FRIABLE ASBESTOS CONTAINING MATERIALS

- A. Where exterior non-friable ACM is to be removed outdoors, post asbestos abatement warning signs and erect temporary barricades to create regulated areas. Regulated areas should be kept clear of any persons not fully trained and protected against exposure.
- B. Install single six (6) mil drop cloths under pipes to be removed to collect debris which may be generated during the removal of sewer piping.
- C. Maintain an operable remote worker decontamination chamber during exterior abatement work unless a Negative Exposure Assessment is submitted for the exterior abatement work.
- D. Maintain a work area access log at each exterior regulated work area. Access into the regulated area shall be established at a designated location.

3.3 ASBESTOS REMOVAL PROCEDURE – EXTERIOR NON-FRIABLE SEWER PIPING

- A. The AAC shall have a designated "Competent Person" on the job at all times to ensure establishment of a proper enclosure system and proper work practices throughout the project. At a minimum, the AAC Competent Person shall perform or supervise the following duties, as applicable:
  - 1. Ensure the integrity of the non-friable abatement work area or the friable abatement containment.
  - 2. Set up procedures to control entry to and exit from the work area.
  - 3. Supervise employee exposure monitoring.
  - 4. Ensure that employees set up, use and remove engineering controls, use work practices and personal protective equipment in compliance with OSHA regulations.
  - 5. Ensure that employees use the worker decontamination facilities and observe decontamination procedures.
- B. Abatement work will not commence until all work area preparation is completed in accordance with this technical specification section.
- C. Maintain a work area access log for each exterior regulated work area. Access into the regulated area shall be restricted to authorized persons.
- D. The AAC shall remove all asphalt and soil to access pipe lengths scheduled to be removed during current shift. The AAC shall take extreme caution not to damage the pipe once identified. Hand digging around pipe prior to removal might be necessary.
- E. Spray asbestos materials with amended water using airless spray equipment or apply approved removal wetting agent to reduce the release of fibers during removal operation. The Owner's Consultant will pre-approve use of amended water as the wetting agent.
- F. Spraying of amended water shall be adequate enough to allow the ACM to absorb the water. Actual removal of ACM shall not be allowed until all ACM has become adequately wet. The AAC shall collect all waste water and dispose of as asbestos waste.
- G. The AAC shall utilize a compression-type cutter to break pipe if full section cannot be removed intact. Crushing or saw cutting of pipe shall not be performed.



- H. Do not create any visible emissions during asbestos removal. Ensure all ACM is adequately wet prior to removal.
- I. The AAC shall HEPA vacuum and wet wipe asbestos-containing sewer piping scheduled to remain of all residues. Apply bridging encapsulant to edge of pipe to remain in preparation of the installation of new piping materials.
- J. Properly package and remove piping from work area as abatement proceeds. Seal piping in a minimum of two (2) layers of 6-mil polyethylene sheeting covering all seams with duct tape. Wet clean each container thoroughly and apply a caution label before moving to holding area.
- K. Remove and containerize all visible accumulations of asbestos-containing and/or asbestos-contaminated debris.
- L. Solidify all liquid waste prior to containerization for disposal.
- M. Sealed disposal containers and all equipment used in the work area shall be included in the cleanup and shall be removed from work areas at the completion of pipe removal.
- N. The AAC shall remove from each work area all abated asbestos containing materials at the end of each work shift.
- O. At any time during asbestos removal, should the competent person suspect contamination of areas outside the work area(s), they shall cause to stop all abatement work until steps to decontaminate these areas and eliminate causes of such contamination are completed. Unprotected individuals shall be prohibited from entering suspected contaminated areas until visual inspections certify decontamination.
- P. If the AAC chooses to saw cut the asbestos-containing pipe rendering the pipe friable, the CTDPH Standards for Asbestos Abatement Sections 19a-332a-1 through 19a-332a-16 will apply. Full containment procedures including critical barriers, two (2) layers of floor and wall polyethylene sheeting, worker decontamination unit, negative pressure and re-occupancy air clearance testing will be required.

#### 3.4 SPECIFIC REQUIREMENTS – SPOT REMOVAL USING GLOVEBAG

- A. Spot repair procedures may be utilized in localized areas where sewer piping will become friable to facilitate pipe removal or disconnects.
- B. Where less than three (3) linear/square feet of ACM is to be removed by “glove bag” operation, post asbestos abatement warning signs and erect temporary barricades to create regulated areas. Regulated areas should be kept clear of any persons not fully trained and protected against exposure.
- C. Provide GFCI devices and temporary power installed in compliance with the applicable electrical codes.
- D. Install one layer of six (6) mil polyethylene sheeting on the ground below the work area.
- E. Install six (6) mil glove bag in accordance with OSHA 1926.1101.

- F. Post all approaches to each work area with asbestos warning signs. Warning signs shall be of size and type that are easily readable and are visible from all approaches to the work areas.
- G. The AAC shall ensure that the following work practice requirements are met:
  - 1. Glove bags shall be installed so as to form an airtight covering over the sewer pipe to which they are applied. Any friable ACM in the immediate area of glove bag attachment shall be wrapped and sealed in two layers of six mil plastic sheeting or otherwise rendered intact prior to glove bag installation. All openings in the glove bag shall be sealed against leakage with duct tape or equivalent material.
  - 2. ACM shall be wet with amended water prior to its removal and maintained in a wet condition inside the glove bag.
  - 3. Any ACM that has been exposed as result of the glove bag operation shall be suitably encapsulated or enclosed so as to prevent the leakage of asbestos fibers prior to the removal of the glove bag.
  - 4. All surfaces from which ACM has been removed inside the glove bag and the upper portions of the glove bag itself shall be cleaned free of visible debris prior to removal of the glove bag.
  - 5. Debris shall be isolated in the bottom of the glove bag by twisting the bag so as to form a closure in the middle. This closure shall then be taped around with duct tape or equivalent material. Air in the glove bag shall be exhausted with a HEPA vacuum cleaner prior to its removal.
- H. Following removal of the glove bag, the glove bag and its contents shall be properly containerized and disposed of as asbestos waste.

### 3.5 FINAL CLEANING AND ENCAPSULATION

- A. Upon completion of gross removal of all ACM specified for removal, the AAC shall begin final cleaning of the effected work area. The AAC shall HEPA vacuum and wet wipe all surfaces of cement sewer piping that remains within the work area.
- B. All tools or equipment that are not necessary for final cleaning shall be decontaminated or bagged and removed from the work area.
- C. The AAC shall ensure that all drop clothes are HEPA vacuum and wet wiped prior to being rolled up and disposed of as asbestos waste.
- D. Once all sewer piping has been removed and components within the work area have been thoroughly cleaned, AND THE WORK AREA IS DRY, the AAC's Competent Person shall perform a visual inspection of all surfaces and components within the work area. The AAC's Competent Person shall sign off on the work area stating that all abatement has been completed for that portion of work and that the work area has met the no visible residue criteria.
- E. The AAC's Competent Person shall then request a final visual inspection to be performed by the Owner's Consultant. The Owner's Consultant shall visually inspect all surfaces and components in the work area for residual debris and or dust. Work areas must be dry for final visual inspection. Inspections will not be performed in work areas where there is standing water

or wet surfaces. Additional cleaning shall be performed at the AAC's expense if the Owner's Consultant identifies visual debris and/or dust during the visual inspection. Additional cleaning shall be performed until the work area meets the no visible residue/dust criteria.

### 3.6 WASTE PACKAGING AND REMOVAL PROCEDURE

- A. The AAC shall strictly adhere to the requirements of this section for ACM waste packaging and transporting waste from the work area to the disposal dumpster.
- B. Waste disposal bags, bundles and drums shall be affixed with pre-printed OSHA warning labels, DOT labels and NESHAP labels.
- C. Each container of ACM waste shall be made adequately wet prior to sealing the container. Bags shall be sealed immediately following additional wetting procedures. Bags of ACM waste shall not be permitted to remain unsealed while in the work area.
- D. Each bag of ACM waste shall be double-bagged during waste load out procedures.
- E. Waste generator labels shall be printed self-adhering labels and shall contain the Owner's name, the site location address, and the AAC's name.
- F. The properly labeled waste shall be transported directly to the lined waste container.
- G. The waste container shall be double lined with 6-mil polyethylene sheeting, posted with OSHA warning signs prior to any loading and unloading operations and shall be kept locked at all times other than loading and unloading.

### 3.7 DISPOSAL OF ASBESTOS AND ASBESTOS CONTAMINATED WASTE

- A. All disposal of asbestos containing and or asbestos contaminated material must be in compliance with requirements of the Office of the Department of Energy and Environmental Protection, State of Connecticut Department of Public Health and the USEPA NESHAP regulations.
- B. Disposal approvals shall be obtained from the CTDEEP before commencing asbestos removal if waste will be disposed of in Connecticut.
- C. Waste container storage locations shall be pre-approved by the Owner and Owner's Consultant.
- D. A copy of approved disposal authorization shall be provided to the Owner and Owner's Consultant and any required federal, state or local agencies.
- E. Copies of all landfill receipts will be retained by the Owner's Consultant as part of the project file. The receipts will be signed by the landfill operator on receipt, and the quantity of asbestos debris leaving the job site and arriving at the landfill acknowledged.
- F. All asbestos debris shall be transported in covered, sealed vans, boxes or dumpsters, which are physically isolated from the driver by an airtight barrier. All vehicles must be properly licensed to meet United States Department of Transportation (USDOT) requirements.
- G. Friable ACM waste shall be placed in double lined enclosed waste containers equipped with a lockable hasp. Waste containers shall be posted with OSHA warning signs during loading and unloading.

- H. All liquid waste generated during the work shall be solidified. At no time will liquid wastes be permitted to be stored on site. Liquid waste generated during this project shall be solidified prior to the end of each work shift.
- I. Completed Waste Shipment Records (WSR) signed by the landfill must be returned to the Owner or Owner's Consultant no later than 45 days from the time the waste was transported off-site. Completed waste shipment records that are not received by the Owner within 35 days shall require the AAC to begin tracking the waste. The AAC must notify the Owner of intentions on tracking the waste.
- J. The AAC must take appropriate actions as outlined in 40 CFR Part 61 NESHAP regulations when completed WSR are not forwarded to the Owner or Owner's Consultant within 45 days from the time the waste was transported off-site.

### 3.8 OWNER'S CONSULTANT RESPONSIBILITY

- A. The Owner has retained the services of Eagle Environmental, Inc. to monitor this project. The Owner's Consultant shall collect and analyze air samples to ascertain the integrity of controls, which protect the area from asbestos contamination. Independently, the AAC shall monitor air quality within the work area to ascertain the protection of employees and to comply with OSHA regulations.
- B. The Owner's Consultant shall collect and analyze air samples during the following:
  - 1. Abatement Period: The Asbestos Abatement Project Monitor shall collect samples on a daily basis during the work period. A sufficient number of background samples shall be taken outside of the work area, upwind and down wind, during abatement activities. Additional samples may be taken inside the work area at the discretion of the Asbestos Abatement Project Monitor.
    - a. The Asbestos Abatement Project Monitor shall provide a continual evaluation of the air quality outside the abatement work area during asbestos abatement, using his/her best professional judgments in respect to the State Department of Public Health guideline of 0.010 f/cc and the background air quality established during the pre-abatement period.
    - b. If the Asbestos Abatement Project Monitor determines that the air quality has become contaminated from the project, he/she shall immediately inform the AAC to cease all removal operations and implement a work stoppage clean up procedure. The AAC shall conduct a thorough cleanup of areas of the areas designated by the Asbestos Abatement Project Monitor. No further asbestos abatement work shall take place until the Asbestos Abatement Project Monitor has determined that the area has been decontaminated.
    - c. Abatement air samples shall be collected for a minimum period of ninety minutes at a minimum flow rate of 12 liters per minute, or as required to obtain a volume of 1,000 liters. Samples shall be analyzed by phase contrast microscopy (PCM) using the NIOSH 7400 protocol.
  - 2. Elevated fiber counts: If elevated fiber counts exceeding the establish pre-abatement level or 0.01 f/cc are recorded, the cause for such elevated readings shall be investigated. If necessary, the AAC shall be responsible for cleaning the affected area and will provide additional support to lower the air born fiber levels. All cost incurred by the AAC for the decontamination work shall be borne by the AAC.

- C. Inspections shall be conducted by the Owner's Consultant throughout the progress of the abatement project. Inspections shall be conducted in order to document the progress of the abatement work as well as the procedures and practices employed by the AAC. The Asbestos Abatement Project Monitor shall perform the following inspections during the course of abatement activities.
1. Precommencement Inspection: Precommencement inspections shall be performed at the time requested by the AAC. The Asbestos Abatement Project Monitor shall be informed 24 hours prior to the time the inspection is needed. During the course of the precommencement inspection, the Asbestos Abatement Project Monitor shall inspect the work area and Site. This shall include, but not be limited to, inspection of barrier integrity, the worker decontamination, facility, work area access logs, etc. If during the course of the precommencement inspection, deficiencies are found, the AAC shall perform the necessary adjustments in order to obtain compliance.
  2. Work Area Inspections: Work area inspections shall be conducted on a daily basis at the discretion of the Asbestos Abatement Project Monitor. During the course of the work area inspections, the Asbestos Abatement Project Monitor shall observe the AAC removal procedures, verify barrier integrity, assess project progress, and inform the AAC of specific remedial activities if deficiencies are noted.
  3. Presealant Inspection: Upon the request of the AAC, The Asbestos Abatement Project Monitor shall conduct a presealant inspection. The presealant inspection shall be conducted after completion of the initial final cleaning procedures, but prior to work area encapsulation. The presealant inspection shall verify that all ACM and residual debris have been removed from the work area. If, during the course of the presealant inspection, the Asbestos Abatement Project Monitor identifies residual dust or debris, the AAC shall comply with the request of the Asbestos Abatement Project Monitor, in order to render the area is free of visible residue.

**END OF SECTION**

**SECTION 31 23 00**  
**EXCAVATION AND SITE WORK**

**PART 1 - GENERAL**

1.01 DESCRIPTION

- A. Earthwork shall consist of the excavation and placement, in the manner herein required, of all material taken from within the limits of the work contracted for, the removal of which is necessary for the construction of pavement base, subgrade, drainage facilities, foundations, wastewater pumping stations, retaining walls, berms and other miscellaneous construction to the dimensions and limits shown on the plans or as ordered.
- B. Earthwork shall include the stripping and stockpiling of topsoil at designated locations on site as directed by the Owner/Engineer.
- C. The material to complete this project is available on-site. No off-site borrow will be required.
- D. The work under this section includes the furnishing of all labor, equipment, supplies and materials and the performing of all operations in connection with the work described above.
- E. The Contractor shall take special care to protect existing utilities that may be encountered during the execution of this work.

1.02 RELATED WORK

- A. Section 01 45 23 - Testing Laboratory Services
- B. Section 01 57 13 - Sediment and Erosion Control
- C. Section 01 57 20 - Dust Control
- D. Section 31 23 13 - Formation of Subgrade
- E. Section 31 23 33 - Trench Excavation
- F. Section 32 11 23 - Processed Aggregate Base

1.03 QUALITY ASSURANCE

- A. Codes and Standards: Perform excavation work in compliance with applicable requirements of governing authorities having jurisdiction.
- A. Testing and Inspection Services: Contractor will engage soil testing and inspection service for quality control testing during earthwork operations.
- B. Supervision: Engage and assign supervision of shoring and bracing work to a qualified foundation consultant. Submit name of engaged consultant and qualifying technical experience.

- D. Where Form 817 is referred to, it means "State of Connecticut Department of Transportation Standard Specifications for Roads, Bridges and Incidental Construction, Form 817, 2016" and including all Supplemental Specifications to July 2018.

#### 1.04 SUBMITTALS

- A. The Contractor shall submit test reports and gradation analyses of all materials to be used, which are from off-site sources to the Owner/Engineer for approval. Costs for all test reports on gradation analysis shall be borne by the Contractor.
- C. When required, provide layout drawings for shoring and bracing system and other data prepared and sealed by a registered Professional Engineer licensed in the State of the project. System design and calculations must be acceptable to local authorities having jurisdiction.

#### 1.05 PROJECT CONDITIONS

- A. All information given on the Drawings, or in the Contract Documents, relating to subsurface conditions and existing pipes and other structures is from best sources at present available to the Owner and is for information only.
- B. All such information and drawings of existing construction are furnished only for the information and convenience of the Contractor. It shall be understood and agreed that the Owner does not warrant or guarantee that materials encountered during construction will be the same as those indicated by information given on the drawings. The Contractor must satisfy himself regarding character, quantities and conditions of the various materials and work to be done.
- C. Before starting work, check and verify governing dimensions and elevations. Survey condition of adjoining properties. Take photographs, to record any prior settlement or cracking of structures, pavements, and other improvements. Prepare a list of such damages, verified by dated photographs, and signed by Contractor and others conducting investigation.
- D. Survey adjacent structures and improvements, establishing exact elevations at fixed points to act as benchmarks. Clearly identify benchmarks and record existing elevations. Locate datum level used to establish benchmark elevations sufficiently distant so as not to be affected by movement resulting from excavation operations.
- E. During excavation, resurvey benchmarks weekly, employing a licensed Land Surveyor or registered Professional Engineer, licensed in the State of the project. Maintain accurate log of surveyed elevations for comparison with original elevations. Promptly notify Owner/Engineer if changes in elevations occur or if cracks, sags or other damage is evident.
- F. Prevent the spread of dust during the performance of the work of this section. Methods to be used shall conform to Section 01 57 20 -"Dust Control" of these documents.

G. Use all means necessary to protect all materials of this section before, during and after installation and to protect all objects designated to remain.

H. In the event of damage, immediately make all repairs and replacements necessary to the approval of the Engineer and at no additional cost to the Owner.

#### 1.06 SUBSURFACE DATA

##### A. INVESTIGATIONS

1. All information given on the Drawings, or in the Contract Documents, relating to subsurface conditions and existing pipes and other structures is from best sources at present available to the Owner and is for information only.
2. All such information and drawings of existing construction are furnished only for the information and convenience of the Contractor. It shall be understood and agreed that the Owner does not warrant or guarantee that materials encountered during construction will be the same as those indicated by information given on the drawings. The Contractor must satisfy himself regarding character, quantities and conditions of the various materials and work to be done.

#### 1.08 UNSUITABLE MATERIAL EXCAVATION

- A. Defined as any material containing vegetation or organic matter, such as muck, peat, clay, organic silt, or sod having unsuitable in-situ bearing properties. All encountered unsuitable materials shall be removed and disposed by the Contractor unless otherwise directed. All costs associated with the transport and disposal of unsuitable material shall be borne by the Contractor.

### PART 2 - PRODUCTS

#### 2.01 FILL

- A. On site suitable, excavated materials shall be utilized as "General Fill" as approved by the Engineer and in accordance with Section 31 23 23 – General Fill
- B. Compacted gravel fill shall conform to Section 31 23 25 -Granular Material.

#### 2.02 SHORING AND BRACING MATERIALS

- A. Materials shall comply with Articles M.09 and M.12.13 of Form 817.



- B. Provide suitable shoring and bracing materials which will support loads imposed. Materials need not be new, but should be in serviceable condition.
- C. If wood is part of shoring system near existing structures, use pressure preservative treated materials or remove before placement of backfill.

### **PART 3 – EXECUTION**

#### 3.01 GRADING

- A. Grading shall be performed to the lines, grades, and contours shown on drawings. In areas of parking, drives, and concrete, the Contractor shall form subgrade in preparation for the stone base materials. Formation of Subgrade shall conform to the requirements of Section 2.09.03 of Form 817.
- B. All sedimentation control measures shall be placed prior to beginning construction. The contractor shall be responsible to construct all temporary dewatering basins required for the site work as detailed in the erosion control plans.
- C. Finished grades are shown on the Plans and the Contractor shall grade to those limits. If changes to the plans are made, those changes will be transmitted to the Contractor in the form of a change order.
- D. In fill areas, the topsoil shall be removed and the existing soil shall be proof rolled prior to beginning fill operations.
- E. All soft and yielding material and other portions of the subgrade which will not compact readily when rolled, vibrated or tamped shall be scarified, blended and handled to obtain the proper moisture content to facilitate compaction. At the direction of the Engineer, unsuitable material shall be removed and replaced with gravel.
- F. General fill will be placed between the existing site grades and the proposed site grades. General fill shall also be utilized in excavated areas that must be brought up to grade. After all grading of the subgrade for the backfill has been substantially completed and all drains laid, the backfill shall be brought to the lines, grades and cross-sections shown on the plans or where directed by the Engineer and in accordance with these specifications.
- G. Fill operations shall commence in all low areas and proceed in such manner that the entire fill is raised uniformly and shaped to provide positive drainage at all times. The Contractor shall construct and maintain on the site, all ditches and channels necessary to keep the site in a dry, workable condition. Where water is infiltrating into an excavation, the Contractor shall provide for pumping and other drainage facilities to divert water from such excavation to a water outlet.

### 3.02 TOPSOIL STRIPPING, STOCKPILING AND RESREADING

- A. Prior to general earthwork operations, the topsoil shall be excavated to its full depth within the limits of the proposed improvements.
- B. The stripped topsoil shall be stockpiled on-site, possibly at several locations, which are to be approved by the Engineer. Representative samples will be taken for testing by an approved agricultural testing laboratory as specified in Section 32 91 19 - Topsoil.
- C. All on-site topsoil stockpiles shall be graded to reduce erosion. Immediately after shaping the stockpile, hand broadcast annual rye grass over the stockpile. Place sedimentation control devices around toe of stockpile or as directed.

### 3.03 EARTH EXCAVATION

- A. Earth excavation shall include all materials removed as indicated or directed except water and rock and shall be in accordance with the requirements of Section 2.02.03 of Form 817.

### 3.04 ROCK EXCAVATION

- A. Rock Excavation shall include rock in definite ledge formation and boulders, or the portion of boulders, three (3) cubic yards, or more, in volume.
- B. Where rock is encountered in the excavation, it shall be removed as required to permit the construction as specified. Where explosives and blasting are used, all laws and ordinance of municipal, state and federal agencies relating to the use of explosives shall comply with. Qualified personnel shall perform all blasting and proper precautions shall be taken to protect persons, property or the work from damage or injury from blast or explosion. The Contractor shall be responsible for all damage due either directly or form such operation.
- C. The proposed rock slope shall be pre-split. The pre-splitting of rock and excavation of rock shall conform to the requirements of Form 817 Section 02.02.03-4.
- D. A pre-blast survey shall be conducted by qualified personnel of the Contractor prior to the beginning of blasting operations. The survey will address all facilities within 1,000 feet of the blasting zones. Examples of the facilities are houses, garages, out buildings, utilities, bridges, drainage structures, and wells.

### 3.05 UNSUITABLE MATERIAL EXCAVATION

- A. Remove unsuitable materials, where encountered, in their entirety or as directed. Backfill excavation with Granular Fill or suitable on-site material as directed. Contractor shall remove and place unsuitable material at locations on-site as directed by the Engineer.

### 3.06 PLACEMENT OF FILL

- A. The embankment shall be constructed by depositing successive layers of fill for the full width of the embankment, unless a partial width is permitted by the Engineer. No embankment layer shall be deposited on surfaces of snow or ice, nor shall it be placed on frozen or unstable surfaces.
- B. The depths of each layer, before compaction, shall not exceed the following:
  - 1. For compactors with a static weight of 5 Tons and dynamic force of 10 Tons, layer thickness = 10" or less
  - 2. For compactors with a static weight of 1 Ton and dynamic force of 2 Tons, layer thickness = 7" or less
  - 3. For compactors with a static weight of 0.5 Tons and dynamic force of 1 Ton, layer thickness = 5" or less
- C. The embankment shall be crowned or pitched to provide drainage at the close of each day's operation.
- D. The entire area of each layer shall be leveled off by suitable grading equipment and shall be compacted as hereinafter specified.
- E. No stone over 5 inches in its greatest dimension shall be placed within 12 inches of the elevation of the top of the prepared subgrade unless otherwise approved by the engineer.
- F. Areas to receive topsoil shall be graded to accept the topsoil to within no more than 0.10 feet of the grades shown on the plans. Variations shall not be completely in one direction.
- G. When embankments are to be constructed on slopes steeper than 1 vertical to 3 horizontal, the slope of the existing ground on which the embankment is to be placed shall be plowed deeply or cut into steps before the filling is begun.
- H. Large stones shall not be placed in nests but shall be distributed over the area; and the interstices shall be filled with spalls, finer fragments or earth to form a solid, compact mass.
- I. No rock fill shall be placed above an elevation that is 2 feet below the top of the embankment, unless shown on the plans or approved by the Engineer.
- J. The Contractor shall be required to construct fills and embankments that are stable and non-deforming. The blending of materials may be required to achieve this condition.

### 3.07 COMPACTION

- A. The entire area of each layer shall be uniformly compacted to at least the required minimum density by use of compaction equipment consisting of rollers, compactors, or a combination thereof. Earth-moving and other equipment not specifically manufactured for compaction purposes will not be considered as compaction equipment.
- B. The dry density for soil after compaction shall be not less than 98 percent of the dry density for that soil when tested in accordance with AASHTO T180, Method D.
- C. If necessary to obtain the required compaction, water shall be added to acquire optimum moisture content.
- D. In areas where compaction is found not to comply with Contract Documents, any necessary retesting and recompaction shall be done at the Contractor's expense.
- E. The Contractor shall maintain sufficient reference points to provide vertical and horizontal locations of soil test locations.
- F. Compaction for each layer of fill shall be achieved prior to the placing of subsequent layers and shall conform to the requirements of Subarticle 2.02.03 of Form 817.
- G. Jetting, flooding, or other similar methods of compaction will not be permitted.

### 3.08 TESTING

- A. All percentages of compaction specified herein shall be related to the maximum dry density as established by AASHTO T-99 Method C and verified in the field by AASHTO T-191-61, T-205-64 or an approved Nuclear density testing device. Prior to placing, at least one (1) laboratory test shall be made on a representative sample of each of the fill materials proposed to be furnished for the earthwork operations; to determine gradation and moisture-density characteristics. These tests shall be made by a testing laboratory approved by the Owner.
- B. Field density tests to determine the actual in-place densities being attained shall be made at the Owner's expense and in sufficient quantity to determine that the required compaction is being attained. Costs associated with Re-testing due to initial testing failure shall be the responsibility of the Contractor.
  - 1. In fills within building or retaining wall area, a compaction test shall be performed for every 200 square feet of surface area on each lift.
  - 2. In fills within the roadway limits and all other fills, a compaction test shall be performed for every 1000 square feet of surface area on each lift or as directed by the Engineer.

### 3.09 EQUIPMENT

- A. Where vibratory compaction equipment is specified herein or is directed to be used by the Engineer, all such equipment whether plate-type or roller shall be furnished with a vibrating surface at least twenty-four (24) inches in width, and capable of operating at a minimum of 2,000 blows per minute. Equipment not specifically designed as vibrating compaction equipment shall not be permitted for compaction of either existing in-place materials or of fills, refills and backfills. Plate vibratory tampers specified for compaction of materials shall be commercially manufactured by Jackson Vibrators, Inc., Ludington, Michigan; the Wacker Vibratory plate compactors as manufactured by Wacker Corporation, Hartford, Wisconsin; the Jay vibratory plate tamper as manufactured by the Jay Company, Columbus, Ohio; and as approved in writing by the Engineer. Vibrating rollers and vibrating tampers specified for compaction shall be similar and equal to the Vibrating Rollers as manufactured by Essick Manufacturing Company, Elizabeth, New Jersey; the Multiple Vibratory Compactor as manufactured by Jackson Vibrators, Inc., Ludington, Michigan; and as approved in writing by the Engineer. Jackhammers, rubber-tired vehicles, and similar equipment not specifically designed and manufactured for the compaction of granular materials will not be approved for use.

### 3.10 SURFACES TO BE COMPACTED

- A. Surfaces to be compacted shall, unless otherwise specified, be compacted by not less than six (6) complete passes of the approved vibratory compactors, in order to obtain the required percentage of compaction. A complete pass shall consist of the entire coverage of the surface area to be compacted with one trip of the equipment. Each trip of the equipment shall overlap the previous trip by at least one (1) foot.
- B. Dumping, spreading, preparing and compacting of several layers of fill materials across the site may be performed simultaneously, providing there is sufficient total area to permit these operations to proceed in a systematic manner.
- C. No rolling equipment shall be used to compact fill, refill or backfill materials within four (4) feet of the vertical faces of any concrete walls or utility pipes. Plate vibratory tampers shall be used in these restricted areas, and in other areas too confined to satisfactorily use rolling equipment.
- D. It is the intent of these compaction requirements that the minimum in-place dry density of the compacted materials resulting from the specified minimum number of passes of the compaction equipment will be equal to or greater than the minimum percentages specified herein. Additional passes of the specified equipment shall be required if the minimum percentages of ASTM in-place dry densities as specified are not obtained with the minimum passes indicated.

### 3.11 OVERLOAD OF UNDERGROUND STRUCTURES

- A. The Contractor shall be responsible for taking all necessary precautionary measures to assure that the equipment used will not overload underground structures during the compaction of fills and backfills.

### 3.12 DEWATERING

- A. Prevent surface water and subsurface or groundwater from flowing into excavations and from flooding project site and surrounding area.
- B. Establish and maintain temporary drainage ditches, dewatering or settling basins and other diversions outside excavation limits to convey rainwater and water removed from the excavation or run-off from adjacent areas. Do not use trench excavation as temporary drainage ditches.
- C. All dewatering discharge shall be to a settling basin or recharge basin.

### 3.13 SHEETING AND SHORING

- A. Excavations shall be adequately sheeted, shored and braced, as necessary, to permit proper excavation of the work and to protect all slopes and earth banks. Sheeting shall be installed as required to prevent cave-ins or settlement and to protect workmen, adjacent structures and utilities. Shoring and sheeting may be removed as the backfilling progresses, but only when banks are safe against caving. The Engineer may direct that sheeting, shoring and bracing be left in place at any time during the progress of the work, and direct that the sheeting and bracing, to be left in place and be cut off at a specified elevation. In removing sheeting or bracing, care shall be taken to prevent voids. Voids, if formed, shall immediately be filled with sand. The installation of sheeting, shoring and bracing shall comply with the safety precautions as outlined in the Federal Register; Part II; Department of Labor, Occupational Safety and Health Administration, 29 CFR Part 1926; Occupational Safety and Health Standards - Excavation; Time/Rule (latest edition), the Associated General Contractors of America "Manual of Accident Prevention in Construction", and all local and state regulations. Dewatering shall be performed, as required, for all excavations below groundwater level.

### 3.14 MATERIAL STORAGE

- A. Stockpile satisfactory excavated materials where directed, until required for backfill or fill. Place, grade and shape stockpiles for proper drainage.

### 3.15 COLD WEATHER PROTECTION

- A. Protect excavation bottoms against freezing when atmospheric temperature is less than 35°F (1°C) prior to placing any material.

### 3.16 MOISTURE CONTROL

- A. Where subgrade or layer of soil material must be moisture conditioned before compaction, uniformly apply water to the surface of subgrade or layer of soil material, to prevent free water appearing on surface during or subsequent to compaction operations.
- B. Remove and replace, or scarify and air dry, soil material that is too wet to permit compaction to specified density. Soil material that has been removed because it is too wet to permit compaction may be stockpiled or spread and allowed to dry. Assist drying by, harrowing or pulverizing until moisture content is reduced to a satisfactory value.

### 3.17 DISPOSAL OF UNSUITABLE MATERIAL

- A. All material excavated and unsuitable for fill material shall become the property of the Contractor and shall be removed from the site and disposed of by the Contractor unless otherwise directed by the Engineer.

### 3.18 DISPOSAL OF SURPLUS MATERIAL

- A. All surplus material excavated from the site and not required to satisfactorily complete the work, shall become the property of the Contractor and shall be removed from the site and disposed of by the Contractor unless otherwise directed by the Engineer.

**END OF SECTION**

**SECTION 31 23 13  
FORMATION OF SUBGRADE**

**PART 1 GENERAL**

1.01 DESCRIPTION

- A. Work under this specification covers the formation of subgrade in the area of public roads, and private access drives, parking, sidewalks, pads, ramps and curbs. The subgrade is the plane coincident with the bottom of the subbase as shown on the plans or as directed by the Owner/Engineer. The work of formation of subgrade shall be performed at this plane. After all earth excavation for these areas have been substantially completed, the subgrade shall be brought to the lines, grades and cross sections shown on the plans or as directed by the Owner/Engineer.

1.02 RELATED WORK

- A. Section 31 23 00 - Excavation and Site Work
- B. Section 31 23 33 - Trench Excavation
- C. Section 32 11 16 - Subbase

1.03 QUALITY ASSURANCE

- A. Where Form 817 is referred to, it means "State of Connecticut Department of Transportation Standard Specifications for Roads, Bridges and Incidental Construction, Form 817, 2016" and including all Supplemental Specifications to July 2018.
- B. The Contractor shall assist the Owner/Engineer in all testing required; the Contractor will supply any laborers and equipment necessary for assistance in the testing at no additional cost. This work may include, but is not limited to providing material, samples, digging test pits and revising work to meet the intent of the plans and specifications.

1.04 SUBMITTALS

None

**PART 2 - PRODUCTS**

Not Applicable

**PART 3 - EXECUTION**

3.01 CONSTRUCTION METHODS

- A. Formation of subgrade shall be performed in conformance with Form 817, Article 2.09.03.

**END OF SECTION**



**SECTION 31 23 19**  
**DEWATERING, CONTROL AND DIVERSION OF WATER**

**PART 1 - GENERAL**

1.01 DESCRIPTION

- A. Work and materials required by this section of the Specifications consist of the furnishing of all labor, equipment, tools and materials and performing all operations in connection with the dewatering, control and diversion of water and all other operations necessary to maintain "in the dry" conditions of all excavations and work areas of this contract. The Contractor shall be responsible for providing, maintaining, operating and removing all dewatering and other facilities, including all pumping and appurtenant equipment required to maintain in a dry condition the areas in which construction of this contract is to be conducted.
- B. Contractor shall be responsible for performing all required dewatering in a manner to prevent injury to persons or public health and damage to existing facilities or public health and damage to existing facilities or the work in progress.
- C. All dewatering operations shall be conducted in strict compliance with all local, State and Federal environmental permits issued for this Contract.

1.02 RELATED WORK

- A. Section 31 23 00 - Excavation and Site Work
- B. Section 31 23 33 - Trench Excavation

1.03 QUALITY ASSURANCE

- A. Where Form 817 is referred to, it means "State of Connecticut Department of Transportation Standard Specifications for Roads, Bridges and Incidental Construction, Form 817, 2016" and including all Supplemental Specifications to July 2018.

1.04 SUBMITTALS

- A. Contractor shall provide to the Engineer a list of equipment that will be available on site to performed dewatering operations during the course of work.
- B. The Contractor shall investigate and verify existing water levels in the areas of construction and evaluate the need for dewatering while said construction occurs. The Contractor shall furnish the Engineer with the proposed location and details of the plan and the methods he proposes to use to accomplish the described work for the Engineer's approval.

**PART 2 - PRODUCTS**

## 2.01 MATERIALS

- A. Provide all labor, equipment, pumps, drains, well points, cofferdams, piping, incidental materials, generators, electric services, or any facility necessary for the control, collection and disposal of all surface and subsurface water encountered in the performance of the contract work.

## PART 3 - EXECUTION

### 3.01 GENERAL

- A. Excavations for work required under this contract are below existing ground water levels.
- B. Contractor shall operate and maintain all pumps, drains, well points or any facility necessary for the control, collection and disposal of all surface and subsurface water encountered in the performance of the contract work. All excavations shall be kept dry at all times and all construction work shall be performed in the dry, unless otherwise authorized or directed by the Owner.
- C. Any damage to existing facilities or new work resulting from the failure of the Contractor to maintain the work areas in a dry condition shall be repaired by the Contractor, as directed by the Owner, at no additional expense to the Owner. Pumping shall be continuous where specified or directed or as necessary to protect the work and to maintain satisfactory progress.
- D. Where cofferdams are necessary so that the work may be performed in the dry, the Contractor shall design, furnish, install, maintain and remove all such cofferdam facilities. Cofferdams shall be designed to withstand all imposed loads and to prevent injury to persons or damages to existing structures and property and to the work.

### 3.02 WORKMANSHIP

- A. Contractor's pumping and dewatering operations shall be carried out in such a manner that no loss of groundwater will occur. All pipelines or structures not stable against uplift during construction or prior to completion shall be thoroughly braced or otherwise protected against movement or damage.
- B. All dewatering wastewater collected shall be disposed of via infiltration back into the ground as near as possible to the location from which the groundwater was pumped from an excavation. The Contractor shall be responsible for design and maintenance of all infiltration systems. Injection through well sis not permitted. During construction water being disposed of by the pumping and dewatering operations shall be disposed of in such a manner to avoid pollution of existing water courses and wetlands, injury to persons or public or private property or to the work completed or in progress.

- C. All discharges shall be into Temporary Dewatering Basins. Dewatering shall be accomplished by approved methods which have a background record of successful dewatering of similar excavations and subsurface conditions expected to be encountered in the work.
- D. Cofferdams shall be installed to sufficient depths to allow a reasonable depth of below-grade excavation below the work to be constructed. They shall be as watertight as necessary for the construction of the work in the dry. They shall be of such dimensions as to give sufficient clearance for construction and inspection of the work and to permit installation of all necessary dewatering facilities.
- E. Contractor shall be solely responsible for the design, construction, adequacy and safety of all cofferdam facilities and for any injury or damage caused by the installation or failure of the cofferdam facilities.
- F. Cofferdams, including all sheeting and bracing required, shall be removed by the Contractor after completion of the permanent construction unless otherwise directed by the Owner.
- G. Contractor shall be responsible for providing and maintaining all ditching, grading, sheeting and bracing, pumping and appurtenant work for the temporary diversion of water courses and protection from flooding as necessary to permit the construction of work in the dry.
- H. Upon completion of the contract work in each construction area, the Contractor shall remove all temporary construction.
- I. Water shall not be permitted to flow into or through excavations in which work is under way or has been partially completed. The Contractor shall not restrict or close off the natural flow of water in such a way that ponding or flooding will occur and shall at all times prevent flooding of public and private property. All damages resulting from flooding or restriction of flows shall be the sole responsibility of the Contractor, at no additional expense to the Owner.
- J. Contractor's pumping and dewatering operations shall be carried out in such a manner that the groundwater table is unaffected. Excessive dewatering of the excavation and subsurface is expressly prohibited.

**END OF SECTION**

**SECTION 31 23 33  
TRENCH EXCAVATION**

**PART 1 - GENERAL**

1.01 DESCRIPTION

- A. Work under this specification covers trench excavation and backfilling for the installation of all storm water drainage, and associated appurtenances as shown on the plans or as directed by the Owner/Engineer. Furthermore, work under this specification covers trench excavation of earth, rock, and unsuitable materials.

1.02 RELATED WORK

- A. Section 31 23 13 - Formation of Subgrade
- B. Section 32 01 16 - Sawcut Bituminous Pavement

1.03 QUALITY ASSURANCE

- A. Where Form 817 is referred to, it means "State of Connecticut Department of Transportation Standard Specifications for Roads, Bridges and Incidental Construction, Form 81, 2016" and including all Supplemental Specifications to July 2018.

1.04 SUBMITTALS

- A. None Required

**PART 2 - PRODUCTS**

2.01 GENERAL

- A. Lumber used for sheeting, rangers, bracing and other construction purposes shall be sound, straight grained spruce or fir and shall be free from shakes, loose knots and other defects liable to impair its strength or durability. Lumber sheeting may be reused if in good condition.
- B. Steel sheeting components shall meet the requirements of ASTM A328.

**PART 3 - EXECUTION**

3.01 GENERAL

- A. Trench excavation and backfilling shall be performed in accordance with Form 817, Article 2.05.03 and Article 10.01.03

- B. Trench excavation and backfilling shall be performed to the lines and grades necessary to install the relevant stormdrains and appurtenances as shown on the plans or as directed by the Owner/Engineer. In all cases, the banks shall be as nearly vertical as practicable.
- C. Except where rock or unsuitable material is encountered, care shall be taken not to excavate below the depths indicated. The Contractor shall furnish and employ such shores, braces, sheeting, pumps, etc., as may be necessary for the protection of property, proper completion of the work and the safety of the public and employees of the Contractor and the Owner. All bracing, sheeting, etc., shall be removed when no longer required for the construction or safety of the work.
- D. The material remaining at the bottom of the trench upon which the utility bedding is to be placed shall be smoothed and compacted. Any part of the bottom of the trench inadvertently excavated below the specified grade shall be filled with utility bedding at the Contractor's expense and thoroughly compacted to the satisfaction of the Owner/Engineer.
- E. After the excavation is completed; the Contractor shall notify the Owner/Engineer. No masonry, pipe or other material shall be placed in the excavated area until the Owner/Engineer has approved the character of the foundation material.
- F. During excavation, material suitable for general fill shall be piled in an orderly manner a sufficient distance from the banks of the trench to avoid overloading and to prevent slides or cave-ins. All excavated materials shall be incorporated into plan fills or removed and properly disposed of.
- G. Excavation shall consist of the removal of all encountered materials including, but not limited to rock, clay, silt, sand, muck, gravel, hardpan, loose shale, loose stone in masses, boulders, existing pipe, manholes and other concrete or masonry structures, and buried stumps and debris.
- H. Unless otherwise specified or approved by the Owner/Engineer, excavation shall be by cut and cover.

### 3.02 EXTENT OF OPEN EXCAVATION

- A. The extent of excavation open at any time will be controlled by the conditions but shall always be confined to the limits prescribed by the Owner/Engineer.

### 3.03 TRENCH WIDTH

- A. Trench widths shall be as specified on the plans and shall not be unnecessarily widened. Every effort shall be made to keep the sides of the trenches firm and undisturbed until backfilling has been completed and consolidated.

### 3.04 SHEETING AND BRACING

- A. The Contractor shall furnish, put in place and maintain such sheeting, bracing, shoring, etc., as may be necessary to support the sides of the excavation and to prevent any movement of earth other than that intended to be accomplished by the excavation. Such sheeting, shoring and bracing shall be done as may be necessary for the protection of the work and for the safety of personnel and shall comply with the safety precautions as outlined in the Associated General Contractors of America, "Manual of Accident Prevention in Construction", and the "Occupational Safety and Health Act" of 1970 (OSHA). Sheeting, bracing, shoring etc., shall be installed in such a manner as to prevent material in behind the sheeting or bracing from falling into the trench.

### 3.05 SEEPAGE OR SURFACE WATER

- A. To insure proper conditions at all times during construction, the Contractor shall provide and maintain ample means and devices with which to intercept and/or remove promptly and dispose properly of all water entering trenches and other excavations. Excavations shall be kept dry until the structures, pipes and appurtenances to be built therein have been completed to such extent that they will not be floated or otherwise damaged.
- B. All water pumped or drained from the work shall be disposed of in a suitable manner without undue interference with other work or damage to pavements, other surfaces or property. If such water is to be discharged to a stream or storm drainage system, the Contractor shall be responsible for removing all particulate matter which may be deposited in the stream or storm drainage system. The Contractor shall submit his proposed methods or procedures to the Engineer and shall maintain compliance with applicable laws and regulations.

### 3.06 EXCAVATION NEAR EXISTING FACILITIES

- A. Attention is directed to the fact that there are storm drains, water mains and services, sanitary sewer mains and laterals and services, and other utilities in certain locations. Some of these have been indicated, but no attempt has been made to show all of the existing conditions, and the completeness or accuracy of the information given is not guaranteed. In advance of normal machine excavation, location of services shall be investigated and the expected location marked. It shall be the responsibility of the Contractor to contact the appropriate utility company and "Call-Before-You-Dig" (1 (800) 922-4455) at least 72 hours in advance of any excavation to have utility locations marked out. As the excavation approaches these services and other expected pipes, conduits or other underground structures, digging by machinery shall be discontinued, and the excavation shall be done by means of hand tools.

### 3.07 UNAUTHORIZED EXCAVATION

- A. If the bottom of any excavation is inadvertently taken out beyond the limits indicated or prescribed, the resulting void shall be backfilled at the Contractor's expense with gravel fill, sand, pipe bedding, or concrete as deemed appropriate by the Engineer.

### 3.08 ELIMINATION OF UNSUITABLE MATERIAL

- A. If material unsuitable for foundation (in the opinion of the Engineer) is found at or below the grade to which excavation would normally be carried in accordance with the plans and specifications, the Contractor shall remove such material to the required width and depth and replace it with granular fill, pipe bedding, sand, or concrete as directed by the Engineer. All unsuitable excavated material shall become the property of the Contractor and shall be disposed of at no additional cost to the Owner.

### 3.09 DISPOSAL OF SURPLUS MATERIAL

- A. All surplus excavated material shall become the property of the Contractor and shall be disposed of at no additional cost to the Owner.

### 3.10 BACKFILL

- A. Backfill for utility work, above the line of narrow trench limit, shall be compacted in layers not more than six (6) inches compacted thickness. No stones larger than two (2) inches shall be placed within two (2) feet of the utility in backfilling. When any stone is used in the remainder of backfilling, each piece shall be embedded in dirt, and no stone weighting over fifty pounds shall be included in the trench. Nesting of stones will not be allowed.

### 3.11 COMPACTION

- A. The entire area of each layer of fill shall be uniformly compacted to at least the required minimum density by use of compaction equipment consisting of rollers, compactors or a combination thereof. Earth moving and other equipment not specifically manufactured for compaction purposes will not be considered as compaction equipment.
- B. The compaction of backfill shall not be less than 98 percent of the dry density for that soil when tested in accordance with AASHTO T180, Method D.

**END OF SECTION**

**SECTION 32 01 15  
SAW CUT EXISTING PAVEMENT**

**PART 1 - GENERAL**

1.01 DESCRIPTION

- A. Work under this specification covers saw cutting existing bituminous concrete pavement as shown on the plans or as directed by the Owner/Engineer.

1.02 RELATED WORK

- A. Section 33 23 33 – Trench Excavation

1.03 QUALITY ASSURANCE

- A. Where Form 817 is referred to, it means "State of Connecticut Department of Transportation Standard Specifications for Roads, Bridges and Incidental Construction, Form 817, 2016" and including all Supplemental Specifications to July 2018.

**PART 2 - PRODUCTS**

Not Applicable.

**PART 3 - EXECUTION**

3.01 CONSTRUCTION METHODS

- A. All bituminous concrete pavement to be removed shall be cut uniformly along lines as shown on the plans or as directed by the Owner/Engineer.
- B. Bituminous concrete pavement shall be cut with an approved concrete saw completely through the full depth of the pavement.
- C. Bituminous curbs shall be cut at the designated lines.

**END OF SECTION**



**SECTION 32 11 16**  
**SUBBASE**

**PART 1 - GENERAL**

1.01 DESCRIPTION

- A. Work under this specification covers furnishing and installing subbase materials consisting of a clean mixture of bank or crushed gravel, crushed run stone or any combination thereof, as shown on the plans or as directed by the Owner/Engineer.

1.02 RELATED WORK

- A. Section 31 23 13 - Formation of Subgrade
- B. Section 32 11 23 - Processed Aggregate Base

1.03 QUALITY ASSURANCE

- A. Where Form 817 is referred to, it means "State of Connecticut Department of Transportation Standard Specifications for Roads, Bridges and Incidental Construction, Form 817, 2016" and including all Supplemental Specifications to July 2018.

1.04 SUBMITTALS

- A. Submit certified test results from a testing laboratory to the Engineer for approval. Test results must indicate characteristics of materials, including: gradation, plasticity and compaction. The cost of all testing shall be borne by the Contractor.

**PART 2 - PRODUCTS**

2.01 SUBBASE

- A. Subbase materials shall conform to the requirements of Form 817, Articles M.02.02 , with the exception that reclaimed miscellaneous aggregate shall not be allowed.

**PART 3 - EXECUTION**

3.01 CONSTRUCTION METHODS

- A. Subbase installation shall conform to Form 817, Article 2.12.03.

**END OF SECTION**

**SECTION 32 11 23**  
**PROCESSED AGGREGATE BASE**

**PART 1 - GENERAL**

1.01 DESCRIPTION

- A. Work under this specification covers furnishing and installing processed aggregate base materials consisting of a clean mixture of broken stone as shown on the plans or as directed by the Owner/Engineer.

1.02 RELATED WORK

- A. Section 32 11 16 - Subbase

1.03 QUALITY ASSURANCE

- A. Where Form 817 is referred to, it means "State of Connecticut Department of Transportation Standard Specifications for Roads, Bridges and Incidental Construction, Form 817, 2016" and including all Supplemental Specifications to July 2018.
- B. ASTM DI557-78, Standard Test Methods for Moisture Density Relations of Soils and Soil Aggregate Mixtures using 10-16 LB Rammer and 18 inch Drop. Method C shall be used.

1.04 SUBMITTALS

- A. Submit certified test results from a testing laboratory to the Engineer for approval. Test results must indicate characteristics of materials, including: gradation, plasticity and compaction. The cost of all testing shall be borne by the Contractor.

**PART 2 - PRODUCTS**

- A. Processed aggregate base materials shall conform to the requirements of Form 817, Article M. 05.01. Coarse aggregate shall be broken stone, gravel or reclaimed miscellaneous aggregate shall not be allowed.

**PART 3 - EXECUTION**

3.01 CONSTRUCTION METHODS

- A. Processed aggregate base installation shall conform to Form 817, Article 3.04.03.

**END OF SECTION**

**SECTION 32 12 16  
BITUMINOUS CONCRETE**

**PART 1 - GENERAL**

1.01 DESCRIPTION

- A. Work under this specification covers furnishing and installing bituminous concrete pavement as shown on the plans or as directed by the Engineer.

1.02 RELATED WORK

- A. Section 32 11 23 - Processed Aggregate Base

1.03 QUALITY ASSURANCE

- A. Where Form 817 is referred to, it means "State of Connecticut Department of Transportation Standard Specifications for Roads, Bridges and Incidental Construction, Form 817, 2016" and including all Supplemental Specifications to January 2018.

1.04 SUBMITTALS

- A. Submit mix design and job mix formula for all bituminous concrete, including all coarse aggregate, fine aggregate, mineral filler and liquid bituminous materials to the Engineer for approval.
- B. Submit material delivery tickets for all bituminous concrete and tack coat materials.
- C. Submit material certificate for all bituminous concrete and tack coat.

**PART 2 - PRODUCTS**

2.01 BITUMINOUS CONCRETE

- A. The bituminous concrete materials and mixtures shall conform to the requirements Form 817, Article M.04 **and shall be of the class specified on the plans.**

**PART 3 - EXECUTION**

3.01 CONSTRUCTION METHODS

- A. Bituminous concrete installation shall conform to Form 817, Article 4.06.03.

**END OF SECTION**

**SECTION 33 31 00**  
**POLYVINYL CHLORIDE (PVC) GRAVITY SANITARY SEWER**

**PART 1 - GENERAL**

1.01 DESCRIPTION

- A. The work under this specification covers furnishing and installing polyvinyl chloride (PVC) sewer, including all pipe, fittings and appurtenances, as shown on the plans or as directed by the Engineer.

1.02 RELATED WORK

- A. Section 31 23 33 – Trench Excavation

1.03 QUALITY ASSURANCE

- A. The Contractor shall furnish to the Owner notarized test reports from the pipe and gasket manufacturers including methods of tests by an approved independent testing laboratory to show compliance of all materials furnished under this specification. A copy of each test report is to be attached to the shipping list of each shipment itemizing by size; class and wall type, serial number and date of manufacture. All required testing of pipe materials furnished under this section of the specifications shall be provided by the Contractor at no additional expense to the Owner. The size, class and wall type shall be marked on each length of pipe and fitting in a manner that will not reduce the strength of the pipe or fitting.
- B. The Contractor shall furnish, at no additional expense to the Owner, the services of pipe manufacturer's representatives for such lengths of time as may be necessary to properly instruct the Contractor's personnel in the proper handling, installation and jointing of the piping in accordance with the printed recommendations of the manufacturer of the pipe.

1.04 SUBMITTALS

- A. Submit detailed list of materials and manufacturer technical data for all pipe, fittings and appurtenances to the Engineer for approval.
- B. Submit material certificate for all pipe, fittings and appurtenances.

**PART 2 - PRODUCTS**

2.01 PIPE, FITTINGS & APPURTENANCES

- A. The material required by this specifications shall be new and unused type PSM, SDR-35 PVC sewer pipe with integral bell-and-spigot joints. Pipe and fittings shall meet and/or exceed all of the requirements of ASTM Specification D 3034, latest revision.
- B. Standard pipe lengths shall be 20 feet and 12.5 feet, with a tolerance of one inch. PVC sewer pipe shall meet the following dimensional tolerances given in inches.

Nominal Size	Outside Diameter		Min. Wall Thickness	Wgt/lbs 20' length
	Average	Tolerance		
6	6.275	± 0.011	0.180	43.6
8	8.4	± 0.012	0.240	82.5
10	10.5	± 0.015	0.300	123.4
12	12.5	± 0.018	0.360	176.4
15	15.3	± 0.023	0.437	283.2
18	18.701	± 0.027	0.536	425.8

- B. Each length of pipe and each fitting shall be provided with integral bell-and-spigot ends and accurate joint surfaces. The joint shall be sealed by an Elastomeric gasket so that the joint will remain watertight under all conditions of service, including movement due to expansion, contraction and normal settlement. PVC pipe and fitting joints shall meet or exceed the requirements of ASTM Specification D3212, latest revision.
- C. Elastomeric gaskets for sealing joints shall meet or exceed ASTM Specification F 477, latest revision, for high head application (50-ft. head and above) except as elastomeric gaskets shall meet or exceed the following requirements when tested in accordance with paragraph 8.7 of ASTM Specification D 1869, latest revision:

Properties After Oil Aging

Tensile strength, average decrease max, percent.....	35
Elongation, average decrease, max, percent.....	40
Hardness, average change, points.....	-10 to + 2
Volume change, average, percent.....	-1 to + 15

- D. A suitable watertight system shall be used for connection of PVC sewer pipe to manhole walls. The system shall achieve adequate bond with both the manhole and the pipe to prevent failure or leakage due to settlement or pullout of the pipe at the manhole. The Contractor shall furnish details of his/her proposed system of connection of PVC pipe to

manholes prior to shipment of pipe or manholes to the project for review and approval by the Owner.

- E. Where required, a flexible coupling shall be used to connect dissimilar types and sizes of pipe. Coupling to utilize stainless steel hardware and be as manufactured by Fernco Inc., Pipe Conx by Uniseal, or equal.

### PART 3 - EXECUTION

#### 3.01 CONSTRUCTION METHODS

##### A. INSPECTION

1. All pipe, fittings, and accessories shall be carefully inspected by the Contractor for defects before installation and all defective, unsound or damaged materials shall be rejected. The Engineer will make such additional inspection he deems necessary and the Contractor shall furnish all necessary assistance for such inspection.
2. No pipe joints shall be covered in any way until the joints have been inspected.

##### B. PREPARATION

1. Proper implements, tools and facilities, satisfactory to the Owner shall be provided by the Contractor for the proper and satisfactory execution of the work.
2. The interior of pipe and fittings shall be thoroughly cleaned of foreign matter before being lowered into the trench and shall be kept clean during laying operations.
3. The trench bottom and bedding shall be shaped and compacted to give substantially uniform unyielding circumferential support to the lower quarter of pipe along the entire length of each pipe. Bell holes shall be excavated so that after placement only the barrel of the pipe receives bearing pressure from the trench bottom. Bedding shall be as shown on the plan details.
4. Pipe, fittings and accessories shall be handled, stored, installed, jointed and protected by the Contractor in strict accordance with the printed recommendations the manufacturer of the pipe materials.

##### A. INSTALLATION

1. PVC sewer pipe shall be installed in conformance with ASTM Specification D 2321, latest revision.
2. Pipe laying shall proceed upgrade with the spigot ends of bell-and-spigot pipe pointing in the direction of flow.

3. Each pipe shall be laid true to line and grade and in such manner as to form a close concentric joint with the adjoining pipe and to prevent sudden offsets in the flow line. No spalls, shims or lumps shall be used to raise the pipe to grade. All pipe shall be maintained accurately to the required line and grade. Any pipe that has the grade or joint disturbed after laying shall be relaid. Care shall be taken to insert spigot into bell to the stop line and no further.
4. Trenches shall be kept free from water so as to prevent flotation of the pipes. Pipelines shall be constructed in dry trenches and shall not be laid when the condition of the trench or the weather is unsuitable for such work. At times when work is not in progress, open ends of pipe and fittings shall be securely closed so that no trench water, earth or other substance will enter the pipe or fittings. Pipes shall not be used as conductors for trench drainage during construction.
5. All materials found to be defective during the progress of the work will be rejected by the Engineer and the Contractor shall promptly remove such defective material from the job site. All defective material shall be replaced by the Contractor with new sound material at no additional expense to the Owner. The Contractor shall be responsible for the safe storage of all material.
6. Joint surfaces shall be protected from damage and shall be kept free from dirt or other foreign material at all times; all joint surfaces shall be free from any defects or materials which would impair the proper jointing and watertightness of joints. Pipe and fittings on which, in the opinion of the Engineer, the joint materials or joint surfaces have been damaged, deformed, indented, marred or otherwise become defective will be rejected and shall be removed from the site and the Contractor shall replace the rejected material with the new sound material, at no additional expense to the Owner.

C. DISPLACEMENT AND ALIGNMENT TESTS

1. Sewers shall be checked by the Contractor to determine whether any displacement or deflection of the pipe has occurred, after the trench has been backfilled. A "GO-NO-GO" mandrel shall be drawn through the pipe not less than 90 days after installation. Maximum allowable deflection shall be 7 1/2% of the base inside diameter. If the interior of the pipeline shows poor alignment, displaced or deflected pipe or any other defects, the defects designated by the Owner shall be corrected to the satisfaction of the Owner, at no additional expense to the Owner.

**END OF SECTION**

## SECTION 33 39 00 SANITARY UTILITY SEWERAGE STRUCTURES

### PART 1 - GENERAL

#### 1.01 DESCRIPTION

- A. Work under this specification covers furnishing and installing of sanitary drainage structures, including manholes as shown on the plans or as directed by the Engineer.

#### 1.02 RELATED WORK

- A. Section 01 45 23 - Testing Laboratory Services
- B. Section 01 57 13 - Sediment and Erosion Control
- C. Section 01 57 20 - Dust Control
- D. Section 31 23 00 - Excavation and Site Work
- E. Section 31 23 33 - Trench Excavation
- F. Section 33 31 00 – Polyvinyl Chloride (PVC) Sewer Pipe

#### 1.03 QUALITY ASSURANCE

- A. Where Form 817 is referred to, it means "State of Connecticut Department of Transportation Standard Specifications for Roads, Bridges and Incidental Construction, Form 817, 2016" and including all Supplemental Specifications to January 2017.

#### 1.04 SUBMITTALS

- A. Submit sanitary drainage structure components shop drawings and technical data to the Engineer for approval.
- B. Submit material certification and gradation with specifications for bedding material to the Engineer for approval.
- C. Submit material certificates for all sanitary sewer structure components. All precast concrete drainage structure components shall be appropriately marked with manufacturer stenciled cast date.

### PART 2 - PRODUCTS

#### 2.01 MANHOLE

- A. Manholes shall conform to the requirements of Form 817, Article 5.07.02.



## 2.02 BEDDING MATERIAL

- A. Bedding material shall be shall conform to Form 817, Article M.01.01, No. 67 crushed stone.

## PART 3 - EXECUTION

### 3.01 CONSTRUCTION METHODS

- A. Sanitary sewer structures installation shall conform to Form 817, Article 5.07.03.

**END OF SECTION**

# TAB H

Plans

# UTILITY RECONSTRUCTION PROJECT

## OF

# COOLIDGE STREET & TAFT LANE

WINDSOR LOCKS, CT

PREPARED FOR  
 TOWN OF WINDSOR LOCKS  
 50 CHURCH STREET  
 WINDSOR LOCKS, CT 06096

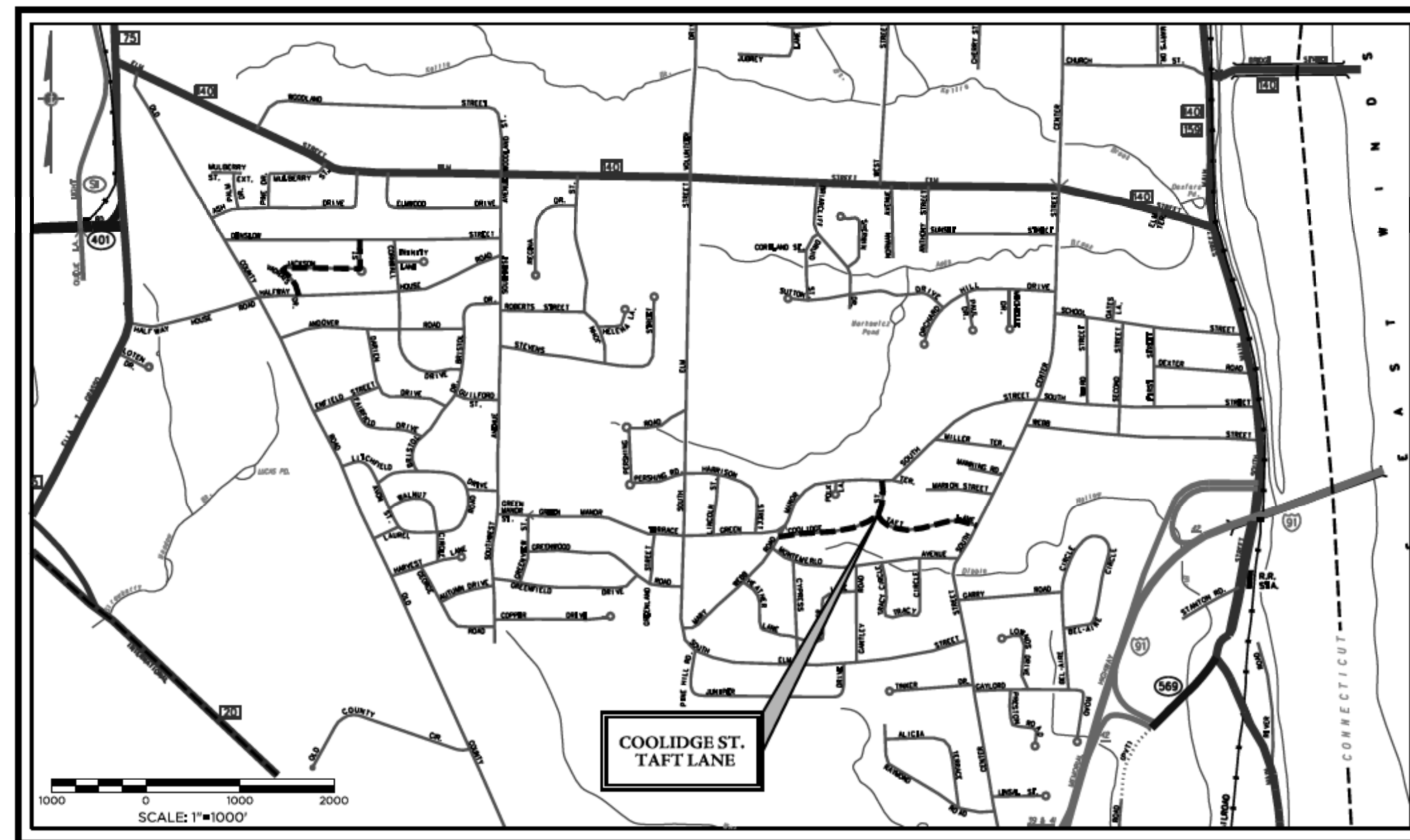

**LOCATION MAP**  
 SCALE: 1" = 1000'

### LIST OF SHEETS

DATE: 5/20/19  
 REVISED:

UTILITY RECONSTRUCTION PLAN  
 CONSTRUCTION DETAILS

1  
 2

PREPARED BY:

 <p><b>ANCHOR</b> ENGINEERING SERVICES, INC.</p>	41 Sequin Drive Glastonbury, CT 06033 Phone: (860) 633-8770 Fax: (860) 633-5971 www.anchorengr.com
	Civil Engineering • Environmental Consulting • Land Surveying • Construction Management



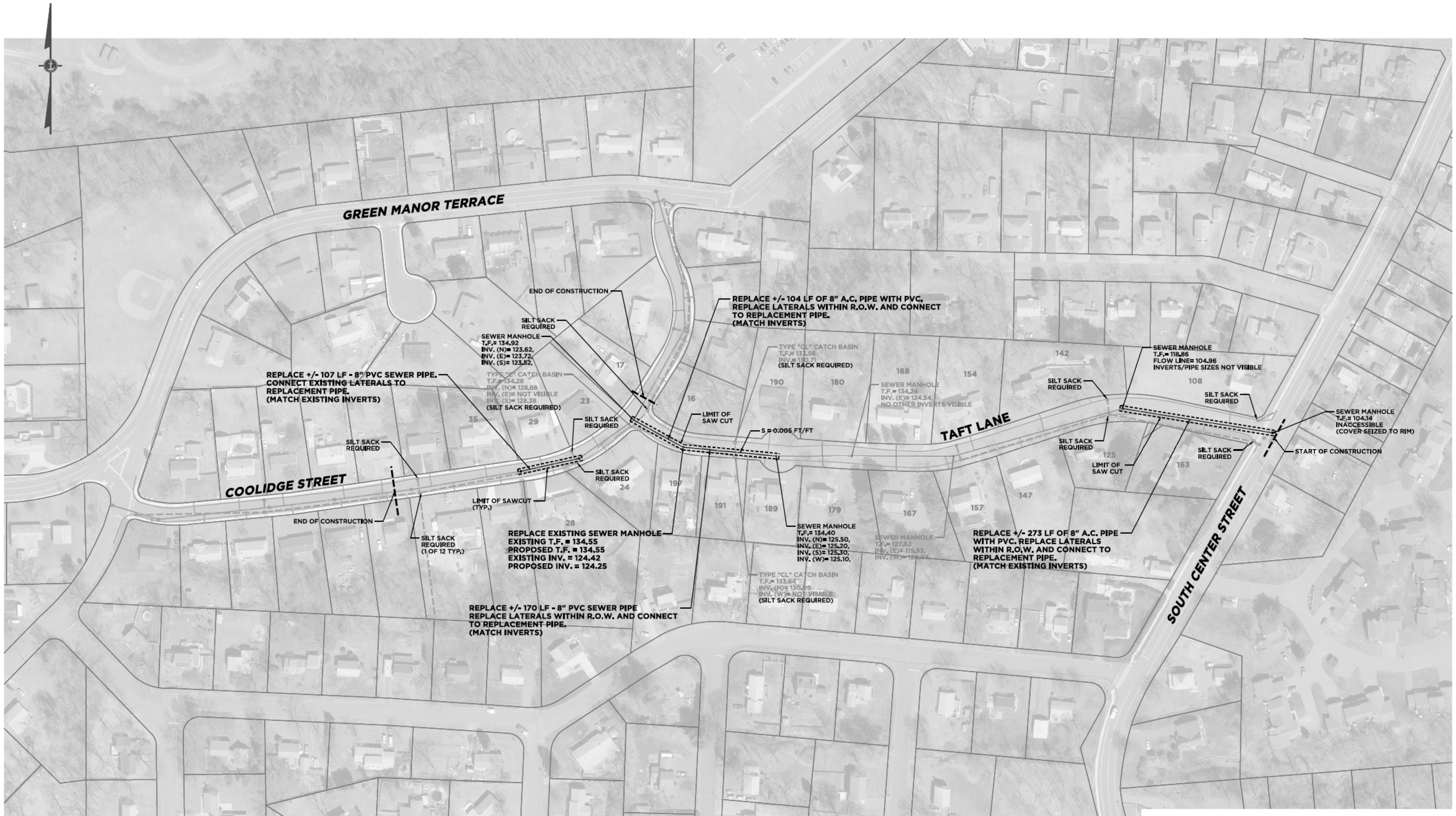

**UTILITY NOTES**  
 UNDERGROUND UTILITY, STRUCTURES AND FACILITY LOCATIONS DEPICTED AND NOTED HEREON HAVE BEEN COMPILED, IN PART, FROM RECORD MAPPING SUPPLIED BY THE RESPECTIVE UTILITY COMPANIES OR GOVERNMENTAL AGENCIES AND FROM OTHER SOURCES. THE LOCATION MUST BE CONSIDERED AS APPROXIMATE IN NATURE. ADDITIONALLY, OTHER SUCH FEATURES MAY EXIST ON THE SITE, THE EXISTENCE OF WHICH ARE UNKNOWN TO ANCHOR ENGINEERING SERVICES, INC. THE SIZE, LOCATION AND EXISTENCE OF ALL SUCH FEATURES MUST BE FIELD DETERMINED AND VERIFIED BY CALL BEFORE YOU DIG; 1-800-922-4455.

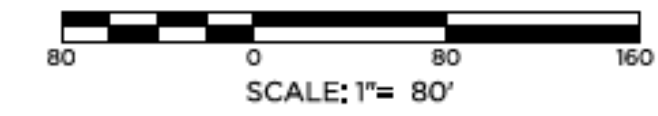

<p><b>ANCHOR</b> ENGINEERING SERVICES, INC.</p> <p>41 Sequin Drive Glastonbury, CT 06033 Phone: (860) 633-9770 Fax: (860) 633-9971 www.anchorengr.com</p>		<p>PROJECT: 145-09</p>	
		<p>DATE: 5/20/19</p>	
<p>PROJ. ENGINEER: MJP</p> <p>PROJ. MANAGER: MNB</p> <p>OFFICE REVIEW: MLK</p>		<p>REVISIONS:</p>	
<p>SCALE: 1"=80'</p>		<p>SHEET NO. 1 OF 2</p>	

**UTILITY RECONSTRUCTION PROJECT**  
 PREPARED FOR  
 TOWN OF WINDSOR LOCKS  
**COOLIDGE STREET & TAFT LANE**  
 COOLIDGE STREET & TAFT LANE WINDSOR LOCKS, CT



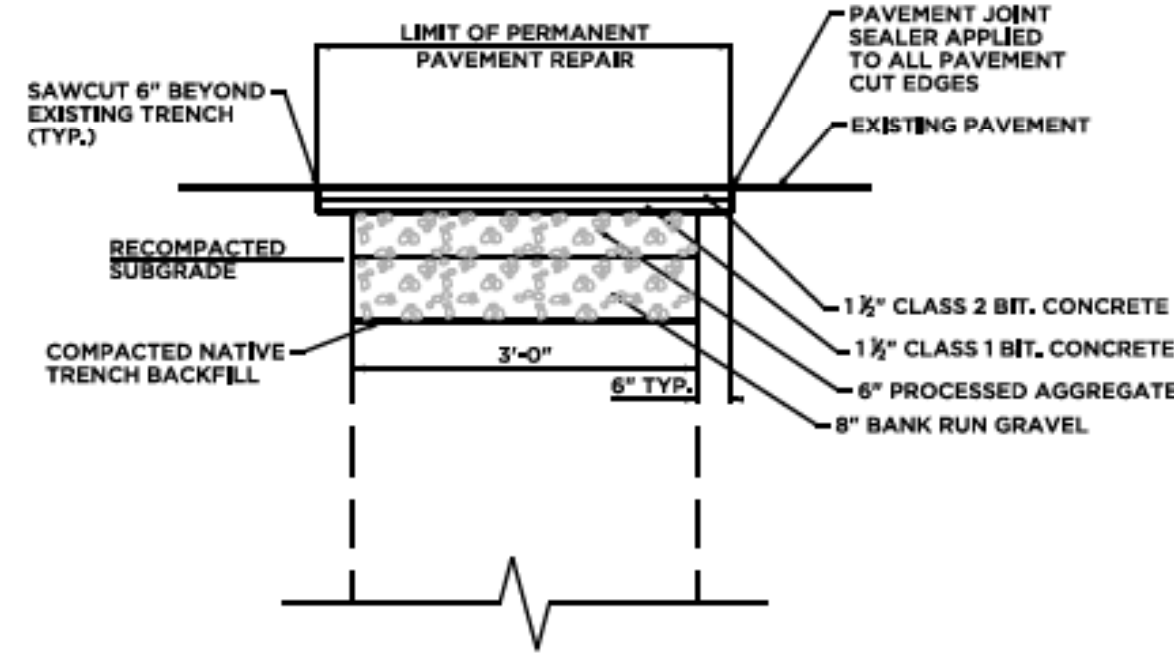

- NOTES:
- THE CONTRACTOR SHALL VERIFY AND SUBMIT PROPER TESTING RESULTS THAT COMPACTION OF THE TOTAL TRENCH AREA MEETS 95% COMPACTED DENSITY.

**TEMPORARY PAVEMENT RESTORATION OVER TRENCH**

NOT TO SCALE

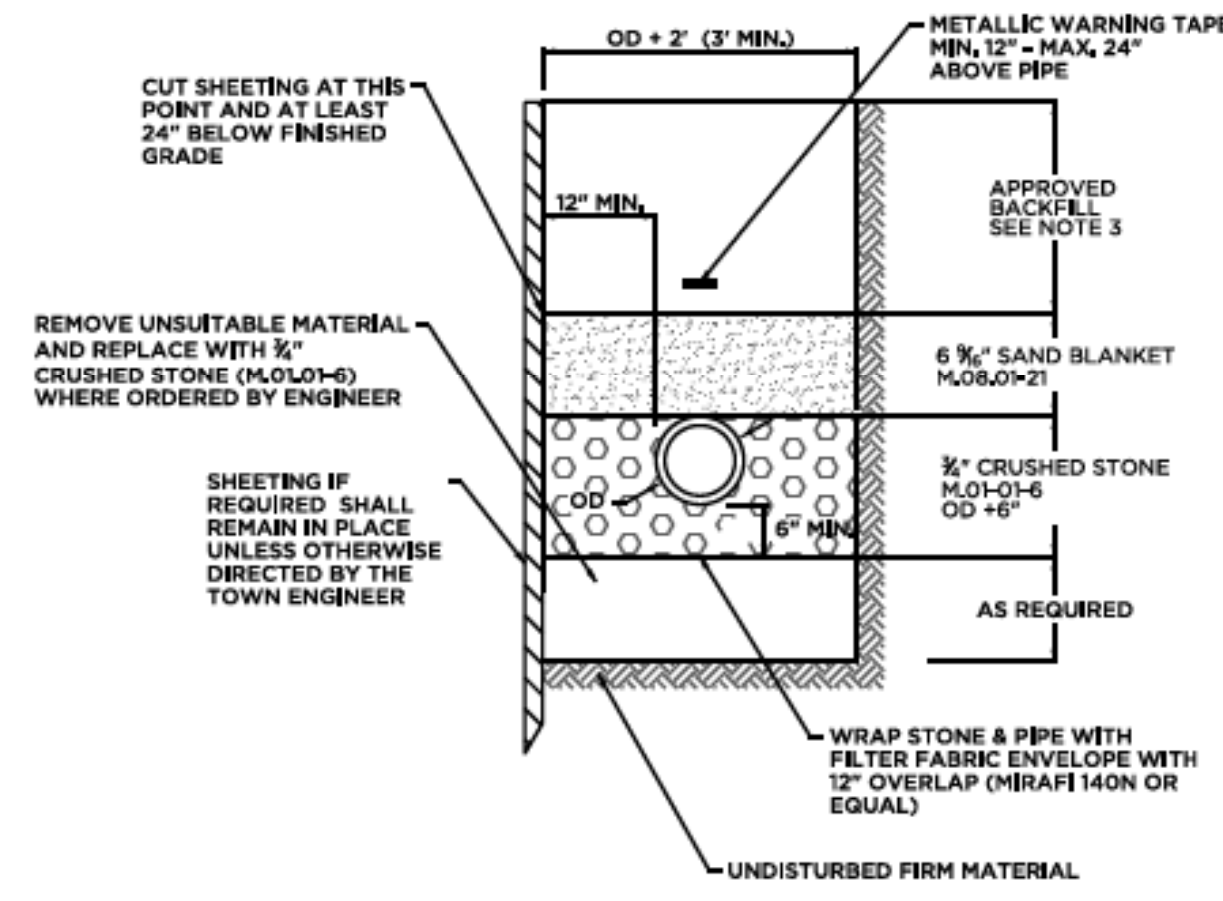

- NOTES:
- PROVIDE SINGLE LAYER OF FILTER FABRIC BETWEEN STONE AND SAND BLANKET WHEN INSTALLING PIPE UNDER UNPAVED AREAS.
  - ALL MATERIALS ARE TO MEET CONN. DOT SPECIFICATIONS FORM 816 AS AMENDED.
  - BACKFILL SHALL BE SUITABLE NATIVE MATERIAL UNLESS DETERMINED TO BE UNSUITABLE BY THE TOWN ENGINEER OR GRANULAR FILL M.02.01 PLACED AND COMPACTED IN 12" LOOSE LIFTS.
  - UNDER PAVED AREAS COMPACT BACKFILL TO 95% OF THE MATERIAL'S MAXIMUM DRY DENSITY AS DETERMINED BY A STANDARD PROCTOR TEST. UNDER UNPAVED AREAS COMPACT TO 90%.

**SANITARY TRENCH SECTION**

NOT TO SCALE

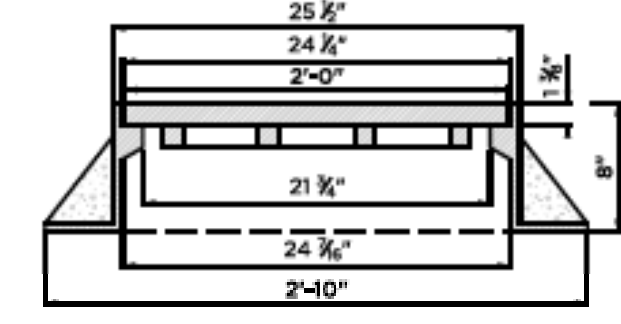
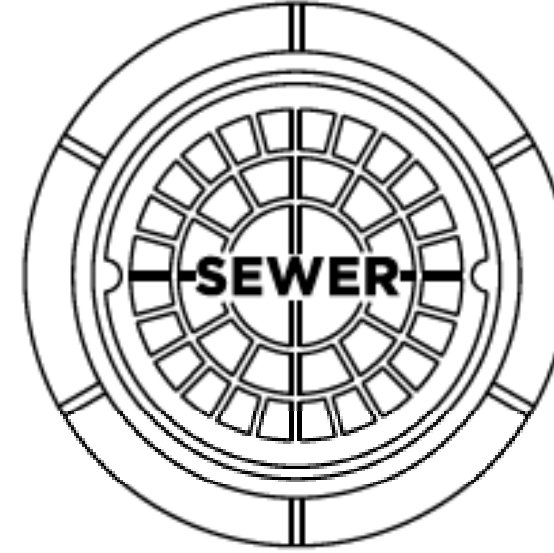

- NOTES:
- MANHOLE COVER TO BE AASHTO HS20-44 HIGHWAY LOADING.
  - FRAME TO BE CAMPBELL FOUNDRY PATTERN NO. 1007D OR APPROVED EQUAL.

**FRAME & COVER DETAIL**

NOT TO SCALE

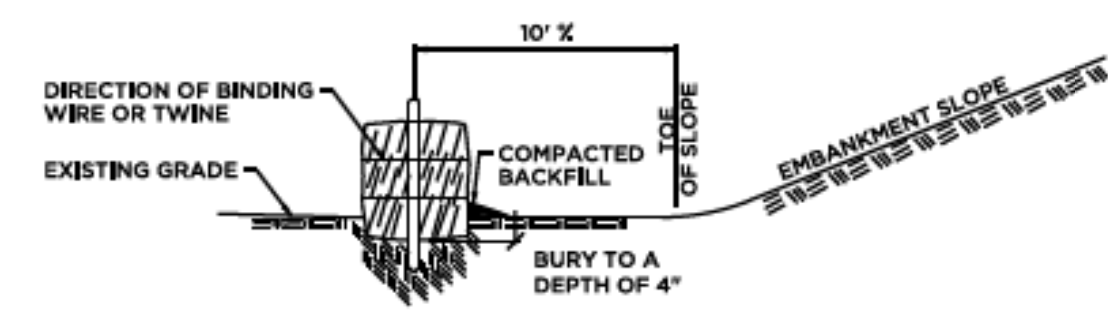
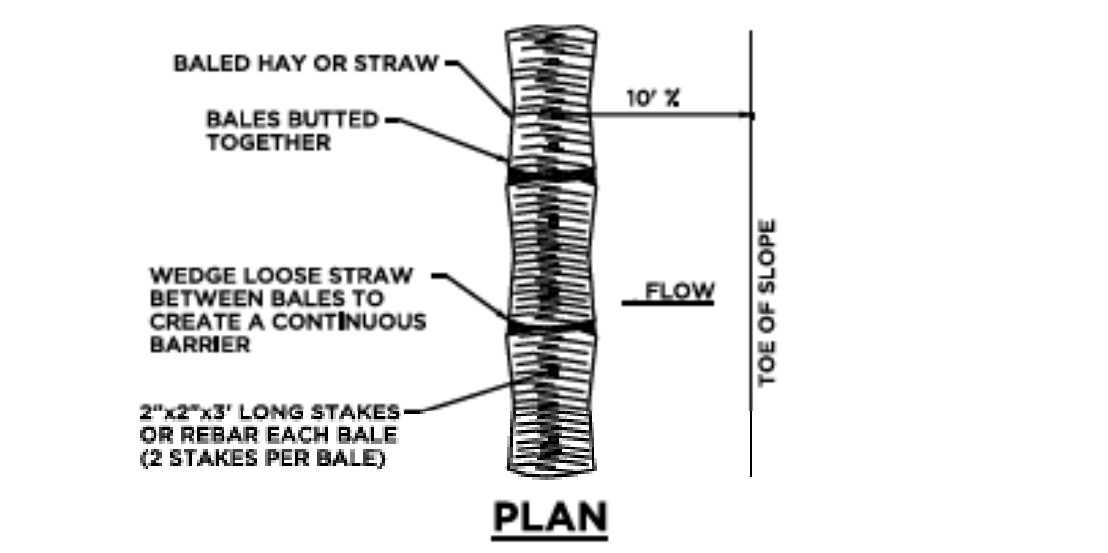

**HAY BALES**

NOT TO SCALE

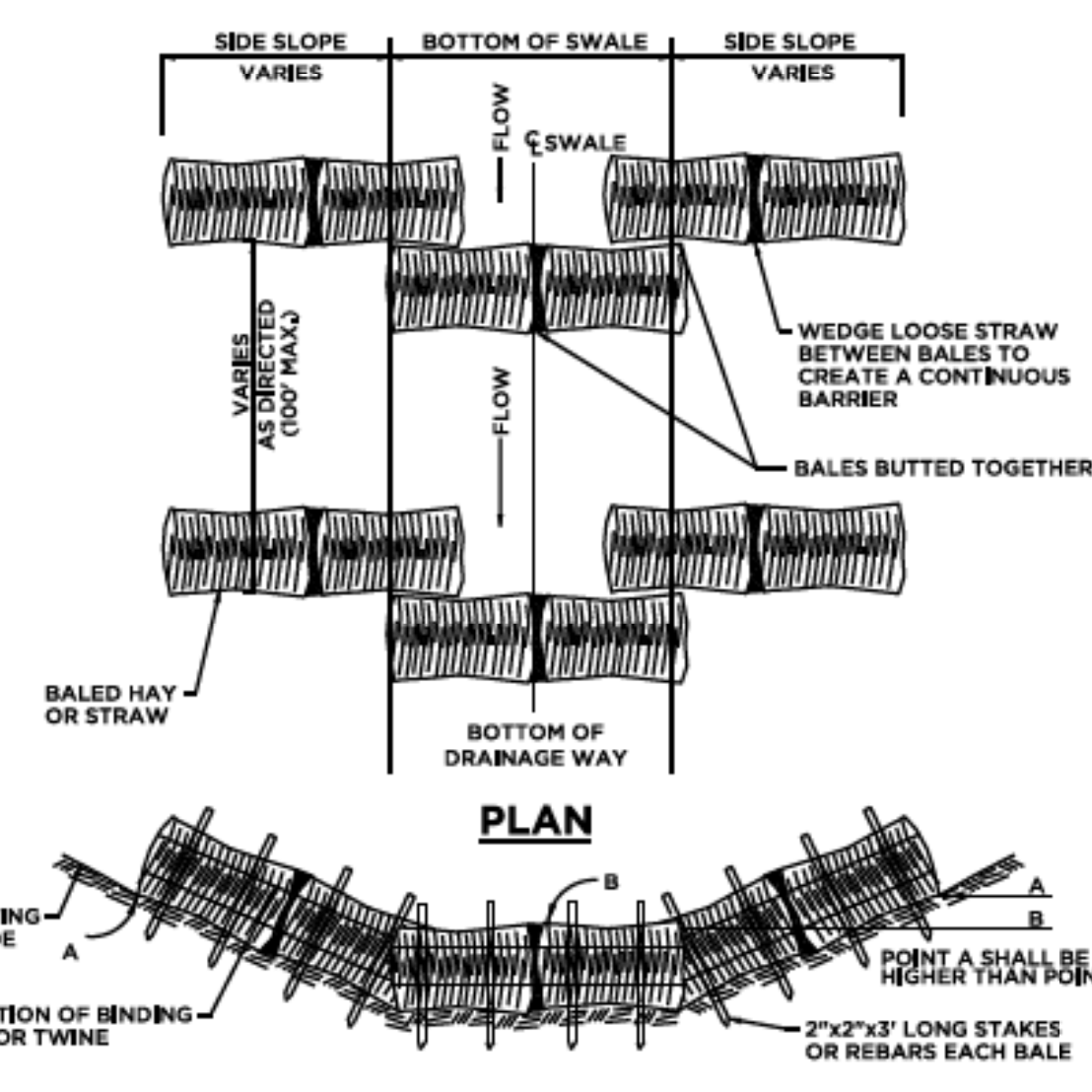

**SECTION AT SWALE**

NOT TO SCALE

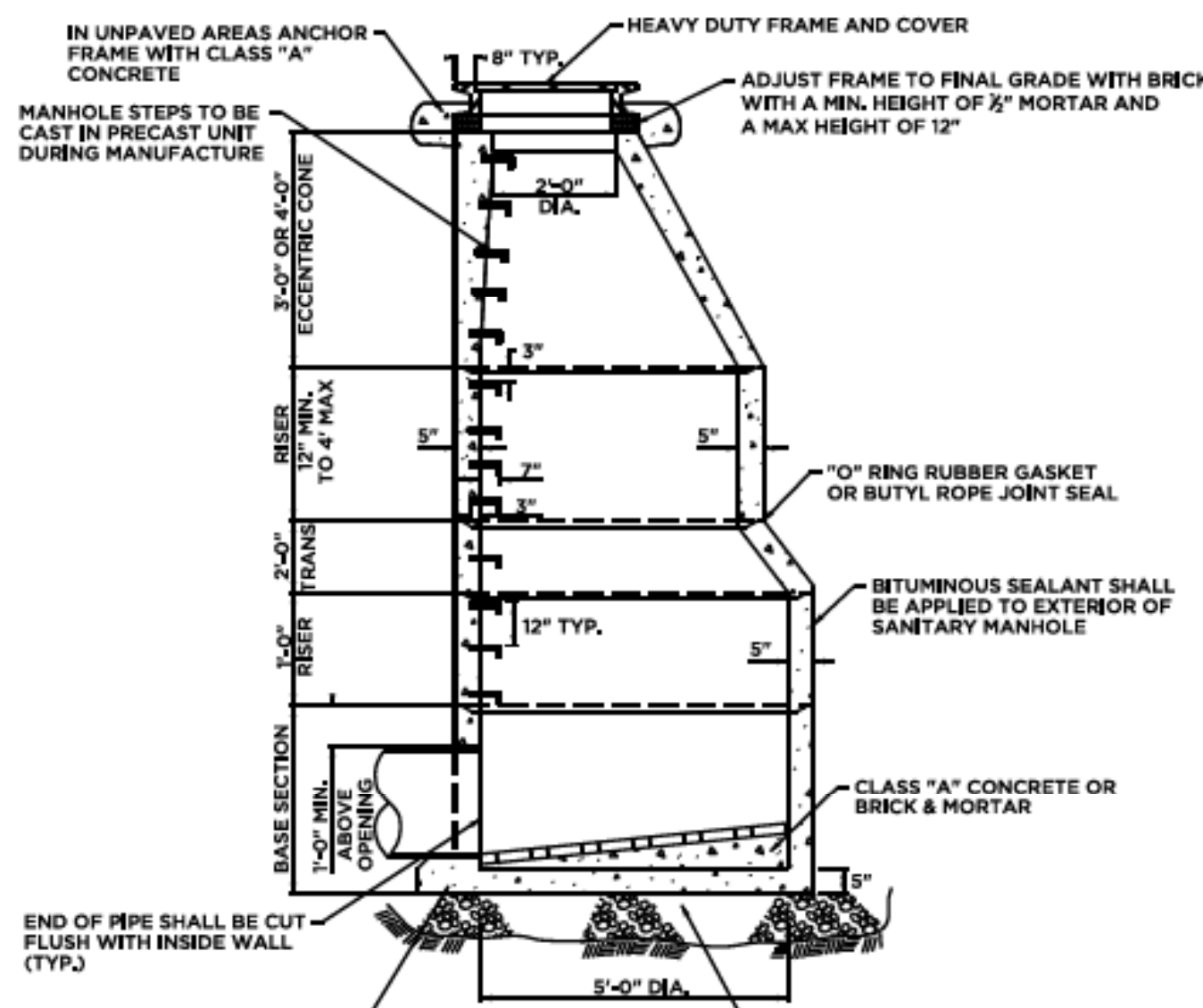

**PRECAST SANITARY MANHOLE**

NOT TO SCALE

**EROSION & SEDIMENT CONTROL PLAN:**

- ALL EROSION AND CONTROL MEASURES SHALL BE INSTALLED AT THE PROJECT SITE PRIOR TO CONSTRUCTION WHEREVER POSSIBLE.
- ALL CATCH BASINS WITHIN THE PROJECT AREA WILL BE PROTECTED THROUGHOUT THE CONSTRUCTION PERIOD UNTIL JUST PRIOR TO PAVING.
- AN EROSION CONTROL SYSTEM SHALL BE INSTALLED AROUND ALL ON-SITE STOCKPILES OF SOIL.
- DUST CONTROL MEASURES SHALL BE APPLIED THROUGHOUT THE CONSTRUCTION PERIOD AND UNTIL ALL DISTURBED AREAS HAVE BEEN STABILIZED.

**EROSION & SEDIMENT CONTROL NOTES:**

- CONSTRUCTION WILL COMMENCE IN THE SUMMER OF 2019 AND WILL BE COMPLETED WITHIN 30 DAYS, WEATHER PERMITTING.
- EROSION AND SEDIMENTATION CONTROL MEASURES SHALL BE INSTALLED AS SHOWN ON THE PLANS, OR AS DIRECTED BY THE TOWN PRIOR TO CONSTRUCTION.
- ALL EROSION AND SEDIMENTATION CONTROL MEASURES SHALL BE CONSTRUCTED IN ACCORDANCE WITH THE STANDARDS AND SPECIFICATIONS OF THE "CONNECTICUT GUIDELINES FOR SOIL EROSION AND SEDIMENT CONTROL", DATED 2002, AS AMENDED AND THE TOWN'S REGULATIONS.
- ALL EROSION CONTROL DEVICES SHALL BE MAINTAINED OR REPLACED BY THE CONTRACTOR DURING THE CONSTRUCTION PERIOD AS NECESSARY OR AS REQUIRED BY THE ENGINEER OR THE TOWN.
- SEDIMENT REMOVED FROM ANY CONTROL STRUCTURES SHALL BE DISPOSED OF IN A MANNER WHICH IS CONSISTENT WITH THE INTENT OF THE PLAN.
- ADDITIONAL EROSION CONTROL MEASURES WILL BE INSTALLED DURING THE CONSTRUCTION PERIOD IF DEEMED NECESSARY OR REQUIRED BY THE ENGINEER OR THE TOWN.
- THE CONTRACTOR WILL BE RESPONSIBLE FOR IMPLEMENTING ALL EROSION AND SEDIMENTATION CONTROL DEVICES AS SHOWN ON THESE PLANS OR AS ORDERED BY THE ENGINEER.

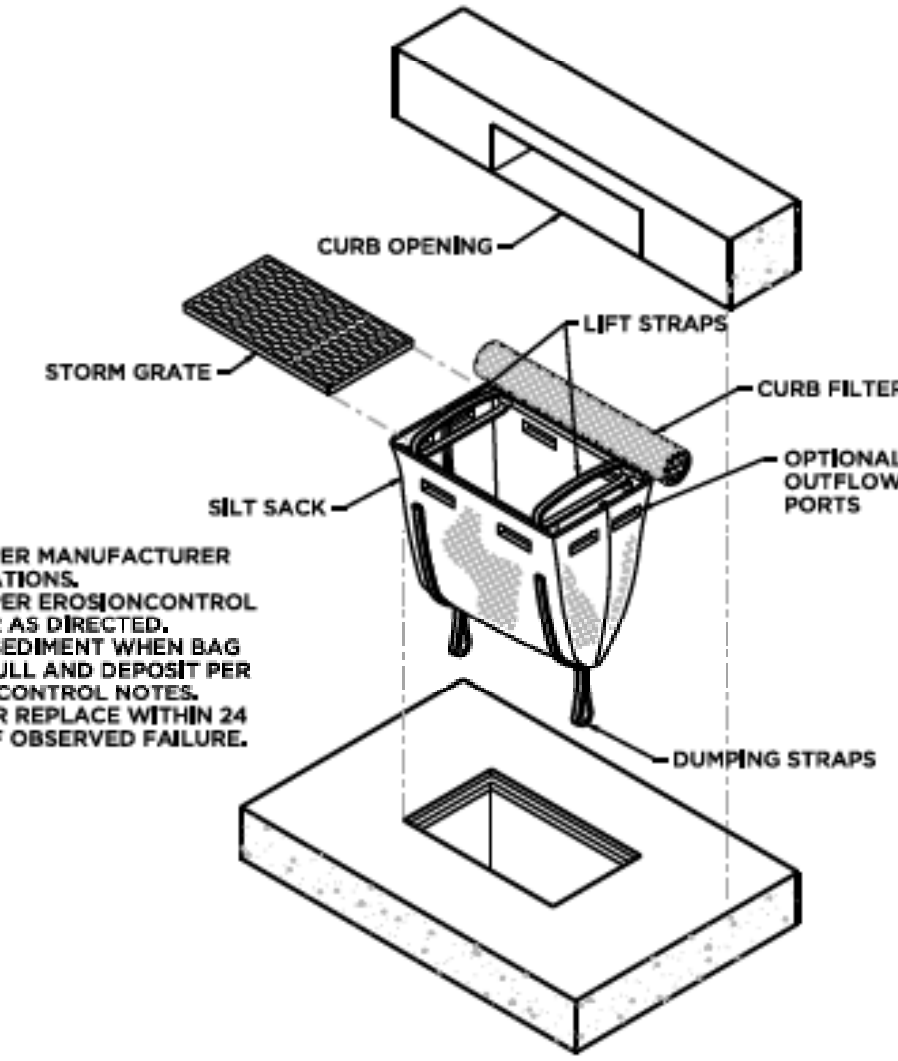

- NOTES:
- INSTALL PER MANUFACTURER SPECIFICATIONS.
  - INSPECT PER EROSION CONTROL NOTES OR AS DIRECTED.
  - REMOVE SEDIMENT WHEN BAG IS HALF FULL AND DEPOSIT PER EROSION CONTROL NOTES.
  - REPAIR OR REPLACE WITHIN 24 HOURS OF OBSERVED FAILURE.

**INLET SEDIMENT CONTROL DEVICE**

NOT TO SCALE

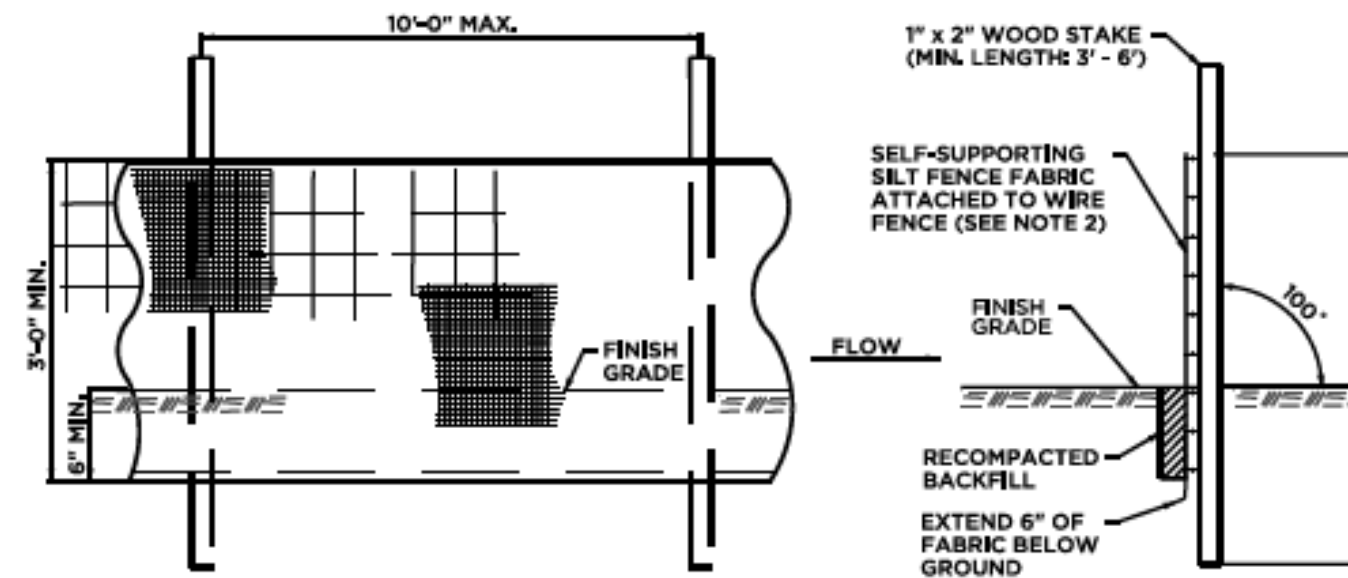

- NOTES:
- INSTALL SILT FENCE & WOOD STAKES AS RECOMMENDED BY MANUFACTURER.
  - SILT FENCE SUBJECT TO HEAVY LOADS SHALL BE REINFORCED WITH FARM FENCING & STEEL POSTS (0.5 # STEEL/L.F.). THE MINIMUM POST LENGTH SHALL BE 5'-0".
  - SILT FENCE FABRIC SHALL BE A PERVIOUS SHEET OF WOVEN PROPYLENE, NYLON, POLYESTER OR POLYETHYLENE FILAMENTS AND SHALL BE CERTIFIED BY THE MANUFACTURER OR SUPPLIER.

**SILT FENCE**

NOT TO SCALE

**GENERAL NOTES**

- AERIAL IMAGERY PROVIDED BY CTECO 2016 ORTHO IMAGERY.
- PROPERTY BOUNDARIES WERE OBTAINED USING TOWN GIS, EXISTING PROPERTY LINES AND RIGHT-OF-WAY LINES WHERE SHOWN ARE APPROXIMATE AND ARE INTENDED FOR GENERAL INFORMATION ONLY.
- DRAINAGE AND SEWER LOCATIONS PROVIDED BY THE TOWN OF WINDSOR LOCKS STORMWATER MANAGEMENT PLAN (APRIL 2017) AND VIDEO INSPECTION REPORT (2014 - TAFT ST, AND 2019 - COOLIDGE ST.) BY MOBILE ROBOTICS INFRASTRUCTURE INVESTIGATIONS.
- TOP OF FRAME AND INVERT ELEVATIONS SHOWN WERE FIELD VERIFIED ON APRIL 24, 2019 BY ANCHOR ENGINEERING SERVICES, INC.
- INSTALL SEWER PIPES TO MEET EXISTING INVERT ELEVATIONS, UNLESS OTHERWISE SHOWN, CONTRACTOR TO MAKE ALL NECESSARY SEWER LATERAL CONNECTIONS.
- THE CONTRACTOR IS REQUIRED TO OBTAIN ALL NECESSARY PERMITS FOR THE WORK TO BE PERFORMED.
- THE CONTRACTOR SHALL CONFORM TO ALL REQUIREMENTS OF ALL LOCAL AGENCIES OF THE TOWN OF WINDSOR LOCKS.
- ALL PROPOSED WORK MAY BE VARIED IN THE FIELD, CONTRACTOR TO FIELD VERIFY ELEVATIONS PRIOR TO CONSTRUCTION.
- UPON COMPLETION OF THE WORK, ALL DISTURBED AREAS SHALL BE RESTORED TO A CONDITION EQUAL TO OR BETTER THAN EXISTED PRIOR TO CONSTRUCTION.
- PRIOR TO BIDDING THE PROJECT, THE CONTRACTOR SHALL VISIT THE SITE TO VERIFY EXISTING CONDITIONS.
- CONTRACTOR SHALL CONTACT "CALL BEFORE YOU DIG" AT 1-800-922-4455 PRIOR TO THE START OF CONSTRUCTION AND RENEW CBYD TICKETS AS REQUIRED FOR THE DURATION OF CONSTRUCTION.
- ALL STREET SIGNS, MAILBOXES, PLANTINGS, ORNAMENTAL OBJECTS, LIGHTS, LANDSCAPE SHRUBBERY, ETC. SHALL BE PROTECTED FROM DAMAGE AND SHALL BE REPLACED IN THE SAME OR BETTER CONDITION BY THE CONTRACTOR IF DISTURBED OR DAMAGED BY THE CONTRACTOR DURING CONSTRUCTION.
- INFORMATION SHOWN ON THE DRAWINGS RELATING TO MATERIALS, CONDITIONS, AND OR LOCATIONS OF EXISTING STRUCTURES AND UTILITIES HAS BEEN COMPILED FROM AVAILABLE INFORMATION INCLUDING FIELD SURVEY, AND TOWN RECORD MAPS AND DRAWINGS, AND IS NOT GUARANTEED ACCURATE OR COMPLETE.
- RESIDENTS WITH DRIVES AFFECTED BY CONSTRUCTION SHALL BE NOTIFIED BY THE CONTRACTOR AT LEAST 48 HOURS BEFORE CONSTRUCTION BEGINS.
- EXISTING UTILITY SERVICES TO REMAIN SHALL BE IDENTIFIED AND PROTECTED DURING CONSTRUCTION.
- CONTRACTOR IS RESPONSIBLE FOR MAINTENANCE AND PROTECTION OF TRAFFIC DURING CONSTRUCTION. MINIMUM ONE-WAY TRAFFIC MUST ALLOW FOR SCHOOL BUS PICK-UP/DROP-OFF DURING DURATION OF PROJECT. SPOT DETOUR ALLOWED BETWEEN 9-2, CONTRACTOR TO COORDINATE AND NOTIFY TOWN 48 HOURS PRIOR TO CONSTRUCTION AND IMPLEMENTATION OF TEMPORARY DETOUR EVENT.

**SEQUENCE OF CONSTRUCTION:**

- COORDINATE AND COMPLETE A PRE-CONSTRUCTION MEETING WITH THE TOWN AND ENGINEER. RESPONSIBLE PARTIES TO BE IDENTIFIED AND EMERGENCY PHONE NUMBERS PROVIDED.
- CONTACT CALL BEFORE YOU DIG PRIOR TO ANY CONSTRUCTION ACTIVITIES.
- INSTALL EROSION CONTROL MEASURES AND ANTI-TRACKING APRON AT THE LOCATIONS INDICATED ON THE PLANS OR AS REQUIRED BY FIELD CONDITIONS.
- SAW CUT AREAS WHERE DEPICTED ON PLAN.
- INSTALLATION/REPAIR OF SEWER PIPE, LATERALS AND STRUCTURES.
- BACKFILL TRENCHES
- TEMPORARY PLACEMENT OF BITUMINOUS CONCRETE PAVEMENT IN TRENCHES.

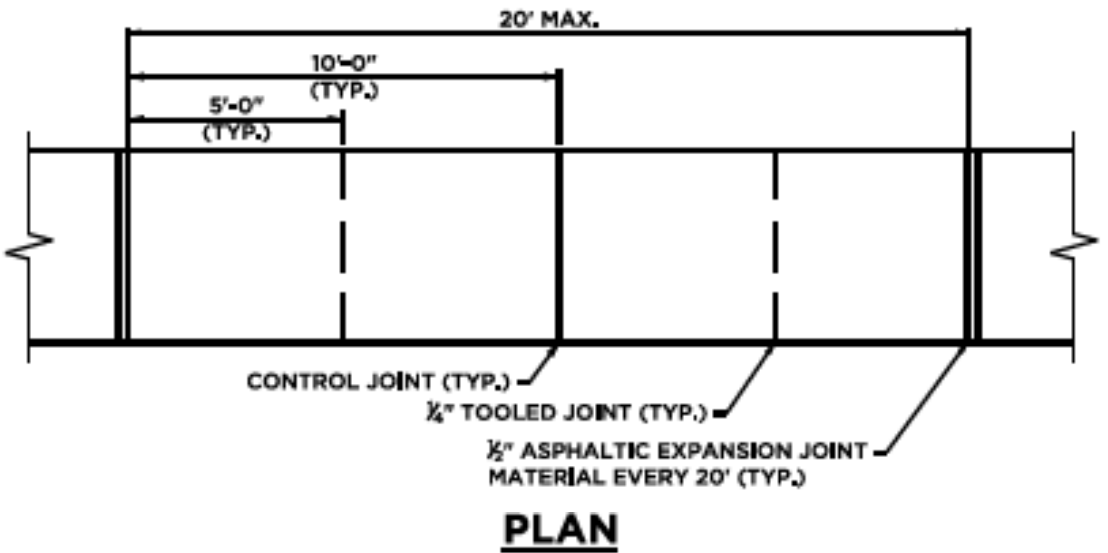

**CONCRETE SIDEWALK**

NOT TO SCALE

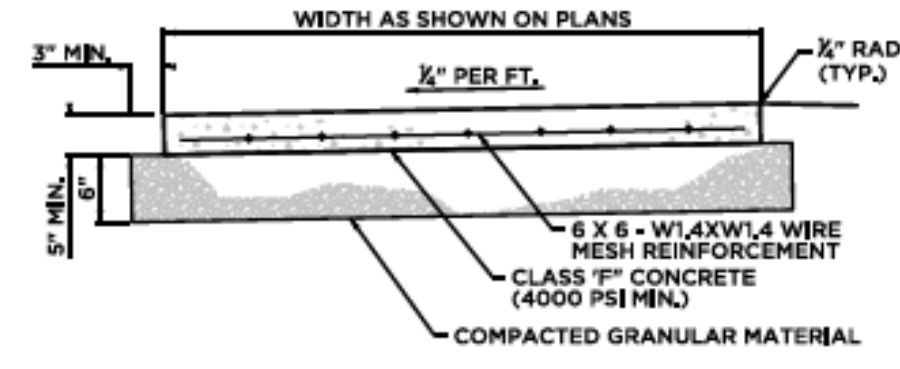

**PROFILE**

NOT TO SCALE

NOT RELEASED FOR CONSTRUCTION

**ANCHOR ENGINEERING SERVICES, INC.**  
 41 Sequah Drive  
 Glastonbury, CT 06033  
 Phone: (860) 633-9775  
 Fax: (860) 633-9971  
 www.anchoreng.com

PROJECT: **UTILITY RECONSTRUCTION PROJECT**  
 PREPARED FOR: TOWN OF WINDSOR LOCKS  
**CONSTRUCTION DETAILS**  
 COOLIDGE STREET & TAFT LANE WINDSOR LOCKS, CT

PROJECT: 145-09 DATE: 5/20/19 SHEET NO. 2 OF 2  
 SCALE: 1"=50'